

ARMS & EQUIPMENT GUIDE



STAR DRIVE

ARMS & EQUIPMENT GUIDE

by Richard Baker

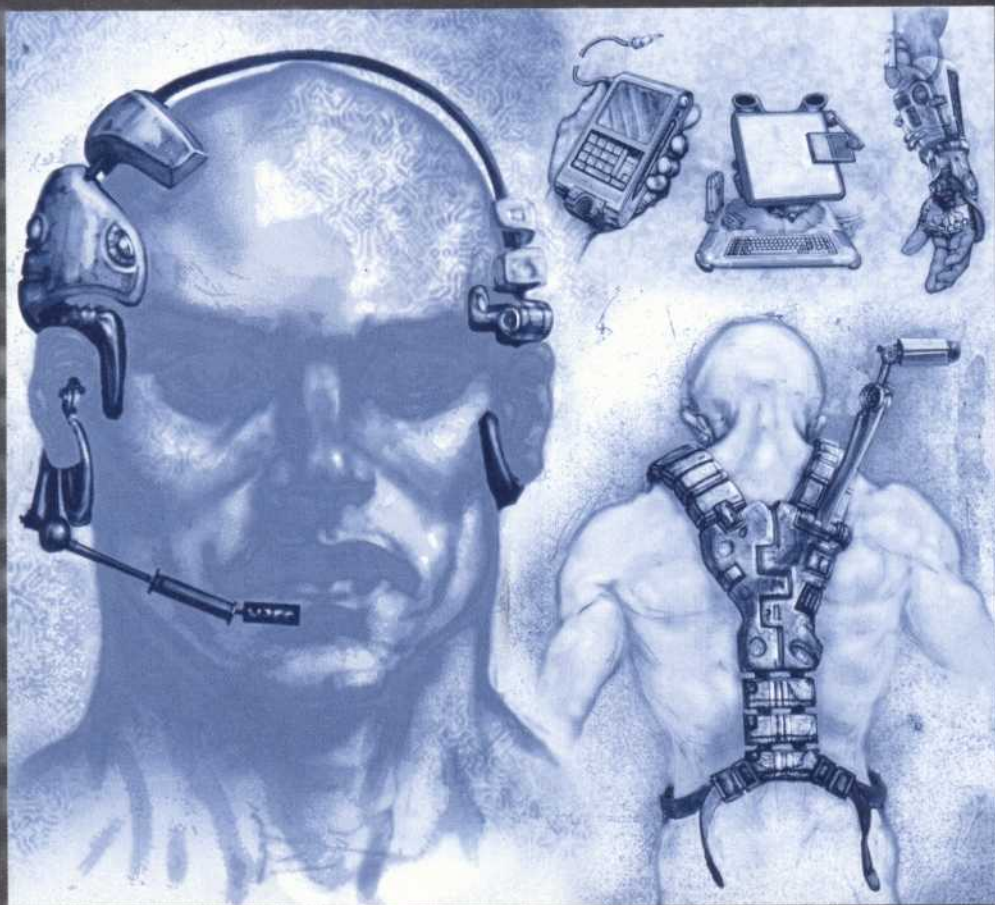

Science Fiction
Roleplaying Game

U.S., CANADA, ASIA,
PACIFIC, & LATIN AMERICA
Wizards of the Coast, Inc.
P.O. Box 707
Renton, WA 98057-0707
800-324-6496



EUROPEAN HEADQUARTERS
Wizards of the Coast, Belgium
P.B. 34
2300 Turnhout
Belgium
+32-14-44-30-44

Visit our website at www.tsr.com

CREDITS

Design	Richard Baker
Editing	Kim Mohan
Brand Manager	Jim Butler
Cover Illustration	Jon Foster
Interior Illustrations	Jon Foster Nemo Halverson Dennis Kauth Rob Lazzaretti Sam Wood
Typesetting	Angelika Lokotz Matt Adelsperger
Graphic Design	Matt Adelsperger
Graphics Coordination	Paul Hanchette

ALTERNITY and the TSR logo are registered trademarks owned by TSR, Inc. STAR[®]DRIVE and the A logo are trademarks owned by TSR, Inc.

All TSR characters, character names, and the distinctive likenesses thereof are trademarks owned by TSR, Inc. Distributed to the book trade in the United States by Random House, Inc. and in Canada by Random House of Canada, Ltd. Distributed to the hobby, toy, and comic trade in the United States and Canada by regional distributors. Distributed worldwide by Wizards of the Coast, Inc. and regional distributors.

This material is protected under the copyright laws of the United States of America. Any reproduction or unauthorized use of the material or artwork contained herein is prohibited without the express written permission of TSR, Inc.

©1998 TSR, Inc. All rights reserved. Made in the U.S.A.

TSR, Inc. is a subsidiary of Wizards of the Coast, Inc.

Visit our website at www.tsr.com

Unless otherwise indicated, ™ and ® indicate galactic trademarks owned by the manufacturers of the items in question.

These trademarks are protected under the terms of the Treaty of Concord.

CONTENTS

INTRODUCTION.....	4
PART I: THE RIGUNMOR STAR CONSORTIUM MERCHANT EXCHANGE.....	6
ACCESSORIES AND CLOTHING.....	6
MEDICAL GEAR AND SUPPLIES	16
PROFESSIONAL EQUIPMENT	23
MISCELLANEOUS GEAR	29
PART II: VOIDCORP COMPUCATALOG ONE	32
COMMUNICATIONS GEAR	32
SENSORS	36
COMPUTERS	40
CYBERWARE	43
PART III: MERRICK'S PERSONAL SECURITY REPORT	46
HAND-TO-HAND WEAPONS.....	47
CHARGE WEAPONS	51
SABOT GUNS	54
MASS WEAPONS.....	55
LASER WEAPONS	57
STUTTER WEAPONS.....	58
HEAVY STUTTER WEAPONS	59
BOWS, CROSSBOWS, AND DART GUNS.....	60
ARC GUNS AND FLAMERS.....	61
MISCELLANEOUS DIRECT FIRE WEAPONS	63
ROCKET AND GRENADE LAUNCHERS	64
ROCKET AND GRENADE WARHEADS	66
HOLSTERS AND SIGHTS.....	67
SPECIALTY AMMUNITION	68
ASSAULT GEAR	69
BALLISTIC ARMOR	70
CARBONATE FIBER BODY ARMOR.....	70
POLYMERE ATTACK ARMOR.....	71
CERAMETAL ARMOR	72
NEUTRONITE MAIN BATTLE ARMOR	73
NEUTRONITE SPECIAL BATTLE ARMOR	74
ASSAULT SHIELDS	76
DEFLECTION SCREENS	76
PARTICLE SCREENS	77
ALIEN ARMORS	78
PART IV: THE EDGETECH OUTFITTER'S CATALOG.....	80
TERRA X CAMPING ACCESSORIES	81
PLANETWIDE CLIMATE WEAR	83
SOLAR X VEHICLES	85
TRAILTECH EcoTOUR GEAR	88
SOLAR X SHIPYARDS.....	90
COMPILED TABLES	93
TRANSVERGE NEWS PRIME REPORT	96

INTRODUCTION

Heroes are always looking for an extra edge over the nefarious villains that infest most campaigns. Sometimes it's the right skill, better teamwork, or a good plan . . . but other times it's simply a matter of having the right tool for the right job. In this book, we'll take a look at a wide array of instruments, devices, weapons, vehicles, and other useful items that heroes might come across in a STAR*DRIVE™ campaign.

While many of these devices are powerful and ingenious, none are miracle machines—they all operate on concrete principles known to the scientists of the Gravity Age. The STAR*DRIVE campaign is built on imaginary science, an SF plot device in which guesses or speculation about future developments form a springboard for the story. Imaginary science includes technology such as the stardrive and gravity-control devices—items that we don't have any real idea how to make today, but that we might invent in the future.

In speculating about the imaginary science of the Gravity Age, we've tried to avoid blundering into wrong science. Imaginary science is okay as long as you don't contradict facts that we know to be true today, but wrong science (letting helicopters fly in a vacuum, for instance) can seriously damage the credibility of your campaign, especially if you have some clever and observant players in your group. Much as a well-written fantasy story needs rules or limitations for the use of magic, good science fiction needs consistency and accuracy in describing the miracles of the day.

TECHNOLOGY ON THE EDGE

The Gravity Age is a time of progress. For the most part, humankind is happier, healthier, and more productively employed than at any previous point in history. Challenged by the vast unconquered reaches of space on all sides, the human species faces a frontier that can never be tamed, a perpetual spur to grow both politically and socially. But while this new age has unlimited potential, it's not perfect. Some portions of the galactic society don't have access to the luxuries and miracles that abound in the homeworlds of Old Space. Others find that, instead of freeing them from labor and oppression, technology has simply given the ruling classes more effective instruments of repression.

Like everything human, technological advances lend themselves to both positive and negative uses. So, what's life like in the age of the stardrive?

URBANIZATION

Human space is crowded. More than one hundred planets with populations of ten billion or more are scattered

throughout the human stellar nations, and hundreds more have populations of at least one billion. Even with environmental engineering, many planets are stretched to the limits of their carrying capacities.

Long-settled worlds are marked by sprawling megalopolises, cities dozens or hundreds of kilometers across. Cheap and fast mass transit ease traffic congestion and pollution in many megalopolises, but cities are still the focal point for social unrest and criminal activity. On worlds suffering from oppressive governments or economic troubles, the urban sprawl is filthy and lawless. Even in the less populous Verge, dangerous sprawls can be found on Alaundril in the Tendril system and on Penates in the Lucullus system.

Apartment buildings are the residence of choice for most city dwellers. Heat and power are cheap in the Gravity Age; most buildings are electrically heated by power provided by a city-operated mass reactor. Gas mains, steam tunnels, and oil heat only exist in the oldest cities. Sewer and sanitation facilities haven't changed much, although waste reclamation and recycling are far more efficient than in PL 5 systems.

For every Class 1 urbanized world, dozens of settlements and industrial facilities exist on marginal planets. Life in these colonies and outposts is not so pretty—many are company towns under the ruthless administration of corporate magnates, while others are located in such hostile environments that no energy or attention can be spared for creature comforts. People who choose to live in such appalling conditions do so in the hope that their high wages will lead to a better life elsewhere.

THE RIGHT TO WORK

Automation has taken many jobs out of human hands—in the better worlds of human space, very few people work in heavy industry, agriculture, sanitation, or manufacturing. The workforce has shifted to service and leisure industries. The blue-collar assembly line worker isn't found in the highly developed worlds of Old Space. His successor is a highly trained industrial engineer or operator who programs and maintains automated systems that do the actual assembly work.

By 2501, few people need to work in agriculture and industry to support the starfaring societies of the day. Most workers find employment in information, leisure, entertainment, trade, and service industries. This isn't enough to keep everyone on the overpopulated worlds of Old Space gainfully employed. Unemployment runs at 10 to 50 percent in the heartworlds of the Stellar Ring, leaving large populations of disenfranchised citizens in even the most prosperous stellar nations.

While most governments provide subsidized housing,

health care, and meals for their unemployed populations, it's a basic fact of human nature that people like to work. The disenfranchised population, whether it's a small percentage of the urban sprawl or an entire world in economic collapse, is much more likely to be hostile toward the rest of the society. Crime, violence, and anarchy still plague the worlds of the Stellar Ring.

Each stellar nation has a different response to this issue. Some, such as the Thuldian Empire, deport people who can't find positions. Others, such as the Solar Union, maintain vast social programs to support their unemployed populations. The chance to find meaningful work is perhaps the single greatest impetus to humanity's expansion throughout the Gravity Age.

Out in the frontier worlds, there are still continents to tame and industries to build, and almost anyone can find work. Most young colonies haven't had the time to develop leisure industries, so a far greater percentage of the population is involved in serious industrial or agricultural work.

ENTERTAINMENT AND COMMUNICATION

One of the best weapons the establishment has to battle the unrest of mass unemployment is the astounding variety and prevalence of entertainment. In the worlds of Old Space, people who can't or won't find work can lose themselves in a society that stretches across a star system. Culture and learning flourish under the care of millions of well-educated (but jobless) dilettantes. In some places, people devote themselves to academic pursuits, creating fulfilling careers as amateur scientists or artists despite the lack of employment opportunities. In other places, the restless masses scream for ever more violent and spectacular entertainment, drowning themselves in the glamorous world of holo-vision and illicit recreation.

Literally everyone has a personal computer of some kind, even if it's only a small data slate for viewing 3D crystals. Print is finally dead—newspapers, magazines, even novels and comic books are 3D crystals, designed for viewing through any data slate, desktop, notebook, or microcomputer. Stamped and scribed much like a modern compact disk is created, read-only 3Ds cost \$2 to \$10 for a good novel, movie, or professional journal. Almost every home, no matter how humble, has a videoviewer or holoset with access to thousands of channels of programming.

THE 26TH-CENTURY CONSUMER

Cheap interstellar transport hasn't changed the basic laws of supply and demand. Buying a commodity where the supply is high, and then selling it where the demand is great, is always going to be profitable. The only question

is how much it costs the merchant to move the goods from the source to the customer.

Consumer indebtedness is nearly universal in the worlds of Old Space. The trends started by the proliferation of credit cards and consumer loans in the 20th century have become established as the normal economic condition of a healthy postindustrial society. While credit cards damage the society's ability to invest and save, they provide people with the opportunity to purchase goods and services they normally couldn't afford. The manufacturers or providers of these goods experience a higher demand than they would otherwise, which means that more people can work.

Most of the stellar nations have developed legal guidelines for consumer debt. The typical citizen can't run all his credit cards to the limit and then declare bankruptcy—by law, he's not allowed to exceed a certain level of indebtedness. Investments or savings for retirement and education are mandatory in some nations, or publicly provided in others, although a few adopt a policy of economic Darwinism.

THE RIGHT TO BEAR ARMS

In the Stellar Ring, criminals and others who skirt the edge of the law are the only people who own personal weapons. Most people don't own weapons, and wouldn't know how to use them if they did. Obviously, military and police agencies are an exception to this general rule.

Out in frontier regions such as the Verge, weapons are much more prevalent. With so many corporations, governments, and independent stations scattered through space, and no common authority to bind them together, violent crime is a part of life. In the settled worlds of Old Space, maybe one person in a hundred carries a weapon; in more backward areas the number is at least five to ten times greater. But only the most lawless of societies make no effort at all to control the proliferation of personal weapons. Heroes who carry sidearms or blades must relinquish them upon entering civilized areas.

ARMS AND EQUIPMENT IN YOUR CAMPAIGN

The rest of this book offers a brief look at four listings or resources of weapons, armor, and other equipment commonly available in the Verge. A Gamemaster doesn't have to make every item instantly available to all the heroes—every item is subject to constraints of availability, delivery time, and cost. But, in most major cities of the Verge, it should be possible to at least order almost anything in the catalogs mentioned in this book.

THE RIGUNMOR STAR CONSORTIUM MERCHANT EXCHANGE

Considered the definitive resource of everything anybody might ever want to buy, the Rigunmor Star Consortium Merchant Exchange is located at New Manhattan on Umbra V. The Exchange is a colossal facility, sprawling over 80 square kilometers of the city. The Exchange originally served as the registry and licensing center of all Rigunmor merchants, but in two centuries it has grown into a center of Rigunmor commerce.

A character with an Exchange membership (easily obtainable, with yearly dues of *100) is free to enter the Exchange at any time; all other visitors are limited to specific hours in the extensive public areas. Thousands of Rigunmor manufacturers, investors, shipping agencies, and speculative traders maintain offices in this complex, open for business around the clock. Thousands of other minor merchants who can't afford to keep an office open instead retain the services of one of the many commerce agents who work out of the Exchange.

On a quarterly basis, the Exchange publishes a complete catalog of all goods available from its members. The Exchange catalog takes no less than five X3D data crys-

tals, and millions of copies are distributed to major mercantile centers throughout the Concord. While a great number of private citizens order their own goods out of the catalog, the average citizen isn't really the target audience—the Merchant Exchange expects that most of their orders will come from local retailers and traders stocking their shelves.

Each of the catalog's X3D chips features a navigator and utility program designed to help the user locate specific types of products, specific manufacturers, even exacting requirements of minor details in the item he seeks. This program can package and transmit orders by printing order forms (not very common these days), by direct online connection to an approved RSC order center (preferred for insystem orders), or by datastream messaging delivered through any normal comm channels (the usual method for interstellar orders).

IN THE VERGE

With the return of Rigunmor traders to the Verge, the Exchange catalog has become available on Alaundril, Grith, Bluefall, and Alitar, and will probably be available elsewhere within the next few months. The Baoli Trading House on Alaundril has won a prized order center contract and provides an online order service. However, heroes who aren't in the Tendril system must either buy locally or transmit an order via the Grid instead.

ORDERING INFORMATION

Interstellar orders take 3d4 weeks to process and ship, with a shipping charge equal to 25% of the item's value. Fortunately, many local merchants in the Verge stock a broad selection of catalog items. Buying locally allows a consumer to pick up what he wants with no shipping charge or delay.

ACCESSORIES AND CLOTHING

No matter where you live or what you do, it's important to dress for success! You've seen the psych-profiles and the studies—first impressions count. Our catalog includes stylish, practical, and comfortable entries from over two thousand manufacturers throughout the Stellar Ring. Please remember to include a full set of measurements and a body dimension scan for the perfect fit. Remember, clothes make the sentient!

CAMPAIGN TIPS

Stories abound of top-notch gridpilots manipulating the Merchant Exchange datastream order system. It's probably just an urban myth, but people say that criminal shadows have tricked the Exchange into delivering staggering orders without payment.

Another way to get rich from the Merchant Exchange is to convince the RSCME to issue a contract of distribution. The local merchant can order in bulk, and then sell his goods at retail to realize a healthy profit on the deal. When a merchant or firm wins a distribution contract, his name and address are included in the next issue of the data crystal set. When consumers in the vicinity want to place orders with the RSCME, the datastream order is addressed to the local distributor first, which provides the local merchant with the chance to fill the order.

Why would the Merchant Exchange cut a deal like this? The answer is simple: It saves itself the trouble of answering millions of small orders, while keeping the customers happy with faster delivery times and lower shipping costs. The contracted distributor only skims a small percentage for his services, so the RSCME still makes most of the money on the deal. As you might expect, there's a great deal of competition among local merchants for distributorship rights with the Merchant Exchange.

ACCESSORIES

Our catch-all listing for all kinds of accessories to go with your casual, business, or formal attire.

A. TrailTech™ Backpack. Our state-of-the-art hiker's pack is light, strong, and easy to wear. The voluminous main compartment can stow up to .125 cubic meters (100 × 50 × 25 cm) of supplies, gear, and materials; two smaller pockets stow up to .002 cubic meters (10 × 10 × 20 cm) each. Frame extensions and attachment points let you stow items too big for the main compartment across the top or bottom of the pack; the harness and frame can tolerate loads as heavy as 60 kg. When you don't need that much capacity, you can down-telescope the frame and fold the pack to reduce it to a typical biker or book pack. Item 090345991a, \$100, 1 kg

B. Belt. Handy for keeping your trousers where they belong. Available in a bewildering variety of styles. A hidden money pouch or knife sheath can be included for an extra \$50. Item 090103133b, \$20.

C. Briefcase. Most people store their work in data slates and microcomps these days, but the briefcase remains as one of the minor trappings of authority, an emblem of business acumen. The standard briefcase includes a biolock (see page 29) to limit access. A briefcase can hold items weighing up to 20 kg (and 40 × 25 × 10 cm in size). Item 090890045c, \$60, 1 kg

D. Glasses. While the majority of people with minor vision problems choose to have them treated through surgical correction, glasses are still worn by the poor or the fashion-conscious. Glasses negate penalties that would otherwise apply from nearsightedness, farsightedness, and other visual impairments. Sunglasses are also quite popular, eliminating one step of penalties due to bright conditions. Item 004299103d, \$50

E. Gloves. Gloves have two main uses: as fashionable accessories for formal outfits, or as protection for the hands in cold weather. Optionally, gloves might have spikes, broken glass, or similar intimidating components, adding +1 to any damage inflicted in unarmed combat. Item 035182199e, \$25

F. Hat. Woolen caps for winter wear? Pith helmets for

tropical environments? Stylish berets for that retroresistance look? Ball caps with your favorite team or corporate logo, or even a classic ten-gallon hat—we've got 'em! If you prefer something truly exotic (a real Stetson or fashion design), the cost is \$100. Item 090104997f, \$10

G. Jewelry. Earrings, necklaces, bracelets, tiaras, pendants, rings, and other designs are all available. Our most popular models feature silver, 16 or 18k gold, and semi-precious stones, and cost about \$200 to \$2,000 per piece or set. Imitation jewelry made from synthetic stones or gold plate runs \$20 to \$100 per piece. At the other end of the spectrum, truly valuable pieces are made from 24k

SPECIAL TRICKS AND TRAPS

A briefcase, purse, or notebook may seem an affectation in the day of the personal microcomputer, but here are a few nifty devices to make your briefcase an unrivaled business asset:

Armor: We'll add a lining of cerametal armor to make your briefcase bulletproof. Open it up and hit the catch to deploy instant hard cover (+1 increase to hero's resistance modifier vs. ranged weapon fire). Code AR, 2× cost

Comm System: Need to stay in touch? We'll add standard comm gear with an encryption device and an orbital uplink. Code CM, 4× cost

Destruction Device: Never worry about your vital materials falling into the wrong hands again. The charge can be set to go off when an unauthorized user attempts to open the biolock, after a certain time delay, or when the device is opened and/or closed a certain number of times. The explosive is treated as a plasma grenade (see page xx), and destroys anything that happens to be in the case. Code AD, 5× cost

Sensor System: Add a hidden sensor unit that can be controlled by remote radio signals. Just "forget" your briefcase in your rival's conference room, and tune in to the latest developments! Includes video through a hidden button lens (10-meter range), and audio through internal microphones (30-meter range). You can use the control panel to set up timed recording, voice- or motion-activated recording, timed remote feed through the onboard transmitter, or voice-activated remote feed through the transmitter. Other sensors (thermal imagers, etc.) can be installed at the normal cost of those systems. Code ES, 10× cost

Weapon System: This isn't a briefcase at all, but a cleverly camouflaged weapon. Kick-out panels clear the trigger, barrel, and stock for instant use. Any SMG, rifle, or heavy weapon of 5 kg or less mass can be built into a case. The weapon suffers a +1 step penalty to its accuracy due to the awkward construction. Code WS, 3× weapon cost

Hidden Compartment: All you want is a little extra privacy? Our secret compartments are scanproof and foolproof! Code HH, 2× cost

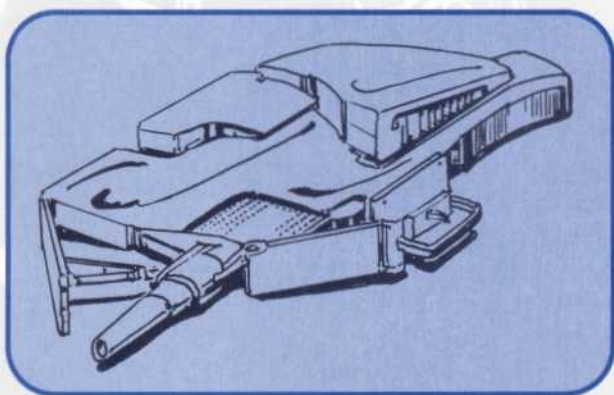

Briefcase Weapon System

or better gold and real precious stones such as rubies, emeralds, and diamonds. These cost \$2,000 to \$20,000 per piece (or ten times as much for jewelry of truly astonishing quality). Item 080004288

H. Pouch. Available in two styles—the fanny pack, worn over the small of the back, and the hip pack, worn on the thigh. A pouch can hold up to 5 kg in mass in a space .0005 cubic meters (5 × 10 × 10 cm) in size. Item 090566213H, \$10

I. Purse. Whether you prefer a serious purse that can tote anything you might care to carry, or an elegant designer model to go with your evening wear, we've got the purse for you. The typical purse can hold about 5 kg, with a volume of 10 × 10 × 5 cm. Item 090299088I, \$30

J. ToolTote™ Utility Harness. A must for anyone who does technical work in difficult conditions, the utility harness (sometimes known as web gear) is worth two extra hands. Keep your tools in easy reach, but out of the way! The harness consists of a wide waist belt and two shoulder belts that cross behind the back. It has twelve different attachment points, each of which can hold a tool or weapon weighing up to 3 kg. Two more heavy-duty attachment points can hold items weighing up to 8 kg. The harness can easily be worn over e-suits, armor, or other clothes. Item 090105682J, \$25

K. Wallet. Paper currency and credit cards may be dead as the dinosaurs on Earth, but everyone needs a place to keep comm numbers, discount cards, or temporary currency. Our wallets include credstick holders and plenty of places to keep your family photos. Item 091288161K, \$40

L. Chronex™ Watch. Precise, durable, and stylish, our watches come in a dazzling variety of masculine and feminine styles. Our basic watch is a sturdy outdoorsman's model, with a wide wristband and a heavy casing certified water-resistant up to a depth of 500 meters. It automatically keeps Concord Standard time, and you can program our timepiece to keep up to twenty other local times. Stopwatch, illuminated face, and magnetic compass included. If you prefer one of our luxury models, you'll get the same features and durability in a jeweled casing and band for only \$5,000! Item 070209301L, \$100

Boots

Whether you're looking for high fashion, comfort, or practicality, we've got the boot for you! Our footwear lines include hundreds of top models from the best manufacturers in the Stellar Ring. Our stock model is a sturdy pair of steel-toed, nonskid working boots suitable for a variety of rugged environments.

Boots can be fitted with magnetic systems for zero-g work for an extra \$100 (see magnetic boots under Survival Gear). Nonskid soles cost \$50 more; these pro-

vide the wearer with a -2 step bonus to Dexterity feat checks or Athletics-climb skill checks resulting from wet, slippery, or uneven surfaces.

A. Stompede™ Armored Boots. When personal safety is your primary concern, you can't beat armored boots. With steel plates embedded in the sole, heel, toe, and shin, and tough Synthi-Leather CF weave construction, you'll find no better protection short of a body tank. Armored boots have an armor rating of 2d4-1 (LI), d6-1 (HI), d6 (En) for damage or attacks directed specifically at the wearer's feet. Item 105498111a, \$250, 2 kg

B. TrailTech™ Hiking Boots. Like to take long walks? You'll want a pair of our top-rated hiking boots. Aerated by hundreds of smart microvents, these boots automatically seal out water and even include heating elements to keep your feet toasty in cold weather. Hiking boots provide a -1 step bonus to a hero's fatigue checks while engaged in an overland march. Item 105223217b, \$150, 1 kg

C. Haynes Co. Western Boots. Tough and stylish, a good pair of boots makes a strong statement about who you are and what you want. Made from our best synthetic leather, these knee-high boots can stand up to any pounding. (Genuine leather boots cost \$600.) Item 105290034c, \$100, 1 kg

BUSINESS DRESS

Feel free to choose from our selection of basic business dress, or customize your appearance by selecting individual pieces described below. Our ensemble includes your choice of slacks or skirt and a matching suit coat. You'll want a dress shirt or blouse, socks or stockings, and shoes to complete your attire.

In today's society, diversity is the only style that matters. With hundreds of major worlds each guided by their own sense of fashion, it's impossible to state with any accuracy what type of business style is in or out. Currently, most of those in the know favor a semimilitary look, featuring double-breasted coats, prominent buttons and fasteners, and narrow collars. Shimmering, almost iridescent, fabrics with strong metallic highlights against a darker material are favored, with very plain accessories.

Other business fashions that are "in" include high-collared mandarin coats,



The Concord look

SPECIALTY FABRICS

Your new clothes might be made of wool, cotton, silk, linen, or any of a dozen different fabrics . . . or they may not be. Any item of normal clothing can be woven from our specialty fabrics for a nominal surcharge. Simply mark your order form with the appropriate code. Regardless of the actual cost of the modified item, the minimum expense for a garment crafted of specialty fabric is \$200.

Antiscan Weave: Imprinted with microcircuits that interfere with most electromagnetic emissions, antiscan weave provides a +3 step penalty to the use of weapon detectors, infrared or radar, or X-rays against the wearer. This drops to a +2 step penalty if the wearer isn't covered from ankle to collar by the garment. Code AS, 3× normal cost

Carbonate Fiber: Made from nanoengineered carbon molecules, CF is the toughest fabric known to man. A garment that provides roughly 50% coverage is equivalent to a CF short coat for protection value, while 75% or greater coverage is equal to a CF long coat. (See page XX for armor description.) Code CF, 4× normal cost, adds 2 kg

Climate Weave: There's no need to ever spend another hour shivering in a frigid board room or sweating it out in tropical heat. Climate weave uses efficient heat-exchange technology to keep you comfortable in temperatures ranging from -40° C to 60° C (-40° F to 140° F), negating any penalties for such conditions. And, while you wouldn't be comfortable anymore, you'll find that you can endure temperatures as low as -70° C or as high as 90° C (at a +2 step penalty, however). Code CW, 2× normal cost

Repellent Weave: Continually charged by your normal motions of walking and moving around, the microcircuitry in repellent weave creates a weak electrostatic field that prevents fluids or powders from adhering to your clothes. You can't stain this stuff! Not only does it stay clean forever, it even keeps you dry in torrential rain or driving snow. Code RW, 2× normal cost

Vacuum Sealed: Do you work someplace where the threat of decompression is real? You'll want your garments tailored with a vac seal. It breathes just like any well-made fabric, but when the air pressure drops, thousands of microscopic vents shut automatically. The cuffs and hems seal with internal membranes, and any standard vacuum mask mates to the collar. **WARNING:** Do not remain in vacuum any longer than absolutely necessary. Vacuum-sealed garments can protect you against depressurization, but extremes of temperature or radiation aren't covered by the manufacturer's warranty. Code VS, 2× normal cost, adds 1 kg

Stealth Weave: You've heard about it for years, but now it's finally available! Using smart image-inducer technology, stealth weave changes its appearance to match the surrounding terrain perfectly. When activated, the wearer gains a -2 step bonus to any Stealth skill checks, and a +1 increase to his resistance modifier against ranged attacks. The charge cell included with this garment is concealed in an interior pocket. It's good for 6 hours of continuous use. Code SW, 4× normal cost; adds 2 kg mass due to charge cell

kimonos, and western rustic garb. Knowing the exact right thing to wear is a function of the Culture-*etiquette* skill; a hero who spends at least \$600 on his business dress gains a -1 step bonus to encounter skill checks while dressed in his suit, provided it's appropriate to the circumstances.

Any piece of business dress can be made from a number of specialty fabrics, described in the accompanying note.

A. Coat, mandarin. A high-collared, close-fitting coat that hangs to mid-thigh, often belted with a colorful sash. Most are embroidered with beautiful floral or oriental patterns. A matching cap is a fashion must. Item 100546879a, \$250

B. Coat, suit. Never out of fashion, this light jacket is available in a variety of cuts and colors. Secret pockets can be included for an extra \$50. Item 100298704b, \$225

C. Haynes Co. Western Coat. The West is back with this stylish suede coat! The collar and cuffs are lined with

real sheepskin. Don't forget a matching hat and boots! Item 100877212c, \$350

D. Kimono, business. Available in hundreds of different prints and materials, the business kimono is an elegant and comfortable robe, accompanied by a silk coat in cold weather. You'll want to find matching undergarments. Item 100379004d, \$400

E. Shirt/blouse, dress. Worn with a suit or western coat, a dress shirt comes in a variety of styles and colors. Item 100144786e, \$25

F. Skirt/dress. Depending on the tastes of the local society, skirts may be cut to the ankle, mid-calf, knee, mid-thigh, or even higher. Stockings are a good idea in cold weather. Item 100642909f, \$50

G. Rauss Co. Trousers. Dress pants in both business and oriental styles are included in this listing. In western styles, well-made jeans are available. Item 100396048g, \$50

CASSOCK

Spirituality is in! Show how little you care about the things of this world by dressing in a garment that emphasizes your indifference to material wealth.

Available in the cut and color specified by every major religious and monastic order registered with the Merchant Exchange, the cassock is a hooded robe that hangs to the ankle. It can be worn over most other clothes, or even light armor (any armor type with an action penalty of +1 or less). Item 130245878, #30

CASUAL DRESS

When you're on your own time, you want comfort, style, and individuality. Our casual lines include entries from the most popular collections of a dozen worlds. Choose one of our matched outfits for #50 (you'll still need footwear of some kind), or select specific pieces, as you prefer.

A. Blouse, casual. Available in a variety of styles and colors, suitable for wear with pants, shorts, or a skirt. Item 110297809a, #20

B. Design du Jour Dress. We have thousands of dress patterns and cuts, ranging from daring evening wear to practical housewear. The garment shown is a lovely sun dress for summertime comfort and style. Item 110344856b, #40

C. Halter. Take advantage of that good weather with this light top! The halter ties behind the neck and across the back so that you can show off your tan to best effect. May not be suitable for all cultures. Item 110212775c, #15

D. Authentic Rauss Co. Jeans. Five hundred years and still going strong! Made of sturdy denim or even tougher synthetics, jeans are suitable for work or for play. We have a variety of colors, cuts, and sizes available in both masculine and feminine styles. Item 110406080d, #35

E. Kilt. Some people prefer a simple kilt to pants. While we have the classic Scottish patterns in inventory, don't forget that men of many other cultures—including African and Micronesian societies—also prefer kilts. Item 110789005e, #30

F. AeroStart™ Athletic Pants. Are comfort and ease of motion your first concern in casual wear? Then take a look at our collection of sportswear and athletic gear! Item 110299361f, #20

G. Robe. Throughout the galaxy, hundreds of cultures prefer to dress in belted or loose robes. We have a variety of national patterns on hand, ranging from the full-body coverings of some Mid-Eastern cultures to light and colorful tunics of classical African pattern. Item 110809056g, #30

H. Sari. Elegant and exotic, the sari is a dress that is wrapped around the body. Originally from southern Asia, it's now a favorite in dozens of starfaring societies. Item 110055698h, #50

I. Shirt, casual. Need something sporty and comfortable? Take a look at our generous line of casual shirts, long-sleeve, short-sleeve, collar or no collar, it's all up to you. Item 110190547i, #20

J. Shirt, crew. The classic tee shirt, with an immense selection of colors, logos, witty sayings, or offensive illustrations. Item 110634225j, #10

K. Shirt, work. Need something a little more durable for your day-to-day labor? Our long-sleeved work shirts are made from tough denim, flannel, or DuraWeave. Item 110631099k, #20

L. Shorts. Perfect for warm-weather climates, shorts are comfortable and stylish. Available in durable outdoor styles or fashionable dress styles. Item 110340341l, #20

M. Skirt, casual. Knee-length or shorter, our casual skirts come in a wonderful variety of prints and cuts. Item 110297855m, #25

N. AeroStart™ Sweatshirt. It's a little too cool for a shirt, and too warm for a coat, so what do you wear? A sweatshirt, of course! We make 'em hooded, collared, pocketed, and zippered—or not, as you prefer. Item 110990104n, #30

O. Trousers/pants. When jeans are a little too casual, a nice pair of trousers can do the trick. Ladies' pants available, too. Item 110578903, #35

CHAPS

In some lines of work, you need all the protection you can get. Made from the finest synthetic leather, chaps mark you as a sentient who knows what he's doing and who's got the right tools for the job!

Chaps are heavy leggings or trousers designed to be worn over another pair of pants as an extra protective layer. For a bold fashion statement, skip the pants and just wear the chaps. Worn in conjunction with a leather coat, chaps increase the wearer's armor protection to d4 (LI), d4-2 (HI), d4-1 (En). Genuine leather chaps cost #300. Available in both western and biker/goth styles. Item 140557986, #75, 1 kg

CLOAK (CAPE, PONCHO, SERAPE)

Whether you just want something to keep the rain off your head, or you want a designer accessory to add the perfect touch to your outfit, we've got the cloak for you!

Cloaks come in two basic models: poncholike outdoorsman's wear and sheer wraps or drapes for fashionable evening wear (the high-fashion variety costs #200). Cloaks and ponchos are often made from specialty fabrics; the vacuum seal isn't effective with this particular garment, but repellent, stealth, or antiscan cloaks are quite common. Item 130199071, #50

COATS

Style, warmth, protection, comfort—our award-winning coat collection has it all! Our basic model is a light waist-length spring jacket, made from the most advanced synthetic materials available. Naturally, our collection features hundreds of other styles.

A. Outback Provisioners™ Duster. A rugged western classic, the duster is a perennial favorite among people who spend a lot of time outdoors. The coat hangs to just past the knee, keeping all kinds of unpleasant weather off your back. Can be cut to hide a shotgun or SMG (reduce the weapon's hide penalty by 1) for an extra \$50. Item 170390871a, \$125, 1 kg

B. Fur coat. Nothing says luxury like a real fur coat. We have beaver, mink, sable, ermine, and a host of synthetic substitutes available (synthetics only cost \$1,500). Please designate your choice of fur. Item 170100678b, \$10,000, 6 kg

C. Haynes Co. Leather Coat. Tough, resilient, and stylish, our leather coats come in flight, bomber, western, and biker cuts. Most are waist-length, but we have long coats that reach to mid-thigh or knee-length dress coats for the ladies (dress coats cost \$800). A leather coat provides a modest amount of protection against some kinds of attacks: its armor rating is d6-3 (LI), d4-3 (HI), d4-2 (En). Item 170505798c, \$500, 5 kg

D. Merrick Industries Neutralizer Coat. It looks like a light jacket, but it's some of the best protection money can buy! The neutralizer coat features a built-in capacitor designed to absorb electrical or pulse attacks. When the wearer is struck by a stun baton, stun grenade, pulse baton, arc gun bolt, or EM grenade blast, the coat's superconducting circuitry absorbs d6 points of the primary damage. (Secondary damage is then figured from the reduced total.)



Neutralizer Coat

The stored damage can be discharged simply by touching another object and depressing a hidden switch. The wearer must make a successful Unarmed Attack skill check to discharge the coat against a hostile opponent. The coat can only hold one "charge" at a time. Should the wearer be immersed in water while the coat is charged, it shorts out and he suffers d8w of energy damage. Item 170994690d, \$1,200, 3 kg

E. TrailTech™ Parka. When nothing less than the finest cold-weather survival clothing will do, you need a

parka. This high-tech version is made of climate and repellent weave. A hero fully dressed in the accompanying mittens, boots, and hood (all included) can endure any H1 environment with ease, withstanding temperatures as low as -100° C (-150° F). Item 170844311e, \$800, 5 kg

F. Raincoat. Like water rolling off a duck's back, rain won't trouble you in our repellent-weave raincoat! Available in short and long coats as well as full head-to-toe rain gear (\$120 for the complete suit). Item 170207553f, \$40, 1 kg

G. Winter coat. The parka's too much, but our standard light jacket isn't enough? No problem! The winter coat stands up to most H1 environments (up to -40° C/F) with ease, and its built-in climate weave can help the wearer to survive in far colder temperatures. Item 170933165g, \$150, 2 kg

FATIGUES

The military look is never out of style! Our fatigues include trousers, shirt, and a matching cap, available in a variety of colors and patterns: olive green, navy blue, light blue, spaceman black, woodland camo, urban camo, winter camo, and desert camo.

While military and paramilitary organizations typically consider fatigues as a working or garrison uniform, fatigues are also popular as industrial or factory uniforms, medical or emergency personnel dress, and even as outdoorsman's garb. They're made from tough, durable synthetic fabrics. Fatigues with a camouflage pattern offer a -1 step bonus to any Stealth skill checks the wearer attempts in the appropriate setting, or a +1 step penalty to an observer's Awareness skill checks to spot him. Item 120595788, \$50

FORMAL DRESS

When impressions count, you want to look your best. Our formal collection is unmatched anywhere in human space. Our basic entry is a cocktail dress or evening gown for the ladies, or an evening jacket, pants, and a formal shirt for the men. If this basic ensemble doesn't suit your taste, please browse through our specific pieces and garments to find the perfect outfit!

A. Coiffure. Any formal headdress, tiara, fillet, or arrangement falls into this category. Both masculine and feminine styles are included. Most coiffures require the efforts of a skilled hairdresser to arrange. Item 130560299a, \$500; \$10,000 for jeweled coiffure, \$100,000 for noble coiffure, 0.3 kg

B. Costume, national. Humankind includes thousands of distinct cultures, each with its own concept of formal wear. The national costume is a work of art, a complete garment in the finest tradition of a hero's homeland. Examples might include a Sioux chieftain's dress, a mata-

dor or flamenco dancer's ensemble, or the wig and robes of an English lord. Item 130295006b, \$1,000, 1 kg

C. Dress, cocktail. A graceful and attractive dress designed to display a woman's charms to great effect. Most are sleeveless and quite short, falling to the mid-thigh. Item 130898769c, \$500; height of fashion, \$1,500, 1 kg

D. Gown, evening. The most formal occasions demand an evening gown, an elegant floor-length dress available in hundreds of styles. Truly exotic gowns might include hidden holoprojectors to create glowing auras, sheer falls of color, or geometric patterns. Item 130103490d, \$500; extravagant, \$2,000; hologown, \$10,000, 2 kg

E. Jacket, dueling. Derived from the popular military styles of the first Galactic War, the dueling jacket is a very short, tight-fitting coat that hangs to the navel. Its cut was originally intended to keep the wearer's sidearm clear of any obstructing clothes, although most people don't wear weapons with the coat any longer. A sash is a must with this dashing jacket. Item 130005677e, \$300, 1 kg

F. Jacket, evening. A more conservative style, the evening jacket is a longer coat suitable for wear in most formal occasions. Item 130006110f, \$350, 1.5 kg

G. Kimono, formal. Larger and more extravagant than the business kimono, the formal kimono features petticoatlike under-ropes and an embroidered silk coat. Item 130788143g, \$900, 3 kg

H. Munson Co. Overcoat. For those times when inclement weather might dampen your formal occasion! Our fine overcoats are fashionable and functional. Hidden pockets or weapon holsters can be sewn in for an extra \$100. Male and female styles available. Item 131913244h, \$400, 1 kg

I. Pants, formal. Tailored trousers suitable for wear with any evening jacket. Item 130366980i, \$80.

J. Robes, ceremonial. Richly decorated with exotic embroidery and layers of resplendent undergarments, these robes command attention and admiration. Item 130447061j, \$1,200, 2 kg

K. Shirt, formal. A must with any good jacket. Item 130801979k, \$40, 0.5 kg

L. Tabard. Neomedieval fashion is popular in the Borealis Republic, the Solar Union, and a number of isolated worlds. The tabard is a loose, sleeveless garment designed to be worn over a tunic or shirt. Usually, it's belted around the waist. Tabards are normally embroidered with house emblems, logos, or similar designs. Item 130104763L, \$150, 0.5 kg

M. Tunic. Another formal top, the tunic is a long-sleeved garment with its hem at mid-thigh. While it's suitable in neomedieval fashions, many high-fashion modern designs have returned to the tunic's classic lines. Tunics can be worn without a jacket in most settings. Formal

hose (see undergarments) are often worn in place of trousers or pants. Item 130664390m, \$200, 1 kg

N. Waistcoat. This elegant coat is a knee-length garment that flares out from the hips. Waistcoats are usually worn over a formal shirt with either pants or formal hose. Item 130804044n, \$600, 1 kg

O. Wrap or Sash. The perfect way to accentuate any formal wear, shawls, cummerbunds, sashes, or wraps are usually decorative instead of functional . . . although a hidden pouch or sheath can be sewn into a sash for an extra \$50. Item 130661330o, \$100, 0.2 kg

JUMPSUIT

When you live and work in space, you've got to be ready to respond to disaster at a moment's notice. Our jumpsuits include an emergency vacuum mask in thigh, shoulder, or lower-back pocket, and seal against hard vacuum in seconds.

The spaceman's jumpsuit is one of the most recognizable garments of the day. It's comfortable, practical, available in any imaginable cut or color—and, with the included vacuum mask, it can serve as a space-suit in a pinch. Item 150055788, \$100, 1 kg



Jumpsuit

PAJAMAS

Whether it's a nightshirt, boxers, a sleeping robe, or plain old flannel, our pajamas ensure a good night's sleep—and stylish early morning wear!

Pajamas don't serve any game function other than providing a hero with decent covering when the terrorists break into his hotel room at 3 A.M. Other than that, suit yourself. Sleep-inducing ultrasonic circuits can be added for an extra \$200 to help the insomniac—when activated, the wearer must achieve an Amazing result on a Resolve skill check or fall asleep within 5 minutes. A -3 step bonus applies for wearers who don't want to fall asleep! Item 160881003, \$30, 1 kg

SHOES

No outfit is complete without appropriate footwear. You want quality and comfort at a reasonable price; we've got it!

Just like boots, shoes can be fitted with nonskid soles for an extra \$50. These provide the wearer with a -2 step bonus when making feat checks or skill checks to avoid slipping or falling on slick or steep surfaces.

Climate weave to keep your feet warm (or cool) is also available at the normal cost.

A. Mikee Athletic Shoes. Light and comfortable, athletic shoes are often designed for specific activities—running, climbing, indoor sports, outdoor sports, and so forth. If a hero wears shoes designed for the exact activity he's undertaking, he gains a -1 step bonus to Athletics or Movement skill checks. Item 105244097a, \$150, 1 kg

B. Business Shoes. Your business suit isn't complete until you've got these comfortable and handsome shoes on your feet! Made from the finest synthetic materials, real leather is available at a cost of \$200 per pair. Item 105104332b, \$50, 2 kg

C. Formal Shoes. What's the point of dressing your best if you have to wear a pair of mangy old sneakers with your tux? Our formal shoes are made from the finest synth-leather (real leather available for \$300). Best yet, the soles include pneumatic cushioning to help you dance the night away! Ladies' heels and flats are available in hundreds of colors and styles. Item 105982109c, \$100

D. Sandals. Best suited for warm climates, sandals have a tough sole with straps or thongs to secure them to the wearer's feet. Some national costumes include sandals, with special socks or hose for cooler climes. Item 105209397d, \$20, 0.5 kg

E. Slippers. Slippers come in two basic varieties—the house slipper and the soled slipper. House slippers are popular as casual wear around the home, and aren't intended to be worn outside. Soled slippers, on the other hand, include moccasins or ninja footwear. They're soft enough to allow a great amount of sensitivity and balance, but tough enough to stand up to vigorous activity in outdoors environments. Item 105877264e, \$30, 0.2 kg

F. Work Shoes. You spend all day on your feet, so you need shoes that are comfortable, tough, and good-looking. Our work shoes include dozens of popular cuts, colors, and styles, with steel soles and toes sandwiched in our best synth-leather. Best yet, our patented DuraShine coat keeps them glossy and perfect with minimal care. Item 105825400f, \$50, 2.5 kg

Socks

You'll want several pairs of socks to go with your boots or shoes. Socks of some kind are required for most business dress, formal dress, and uniforms, and common with most casual wear. Ask about our climate weave or heating elements to ensure that your toes stay toasty!

Any kind of sweat socks, knee socks, dress socks, hose, or stockings are available. Heated socks require a small charge cell and power lead, costing an extra \$10. They're required to make full use of cold weather survival clothing. Item 105202773, \$5, 0.1 kg

ROBES

Comfort and style are yours with our bathrobes, sunrobes, housecoats, and dressing gowns. We also have a wide collection of specific cultural patterns and classic designs for everyday wear.

Exotic robes or costumes cost anywhere from \$50 to \$250, depending on the nature of the outfit. Robes are currently the mode of dress on a number of worlds, including those of the Orlamu Theocracy and the Insight Division. Item 110597200, \$20, 1.5 kg

UNDERCLOTHES

Comfort and style start next to the skin! What's the point of spending hundreds of dollars on a good suit or dress when you're not comfortable? Our standard underclothes includes your choice of briefs, boxers, panties, slips, loincloths, thongs, wraps, supporters, brassieres, tee shirts, or athletic tops.

Underclothes also include petticoats and shifts for some styles of robes and dresses. Sexy or daring lingerie costs \$50 to \$150. Item 160900100, \$10, 0.1 kg

UNIFORMS

We have contracts with all major military and paramilitary organizations to produce top-quality uniforms in the specified patterns. These aren't government-issue; these are tailored garments made to the highest specifications. All of our uniforms include trousers and a jacket—you'll want a tee shirt, dress shirt, or formal shirt to go underneath it. Include your organization code chart on your order form, please!

A. Uniform, battle dress. The soldier's field attire, rugged and ready for business. Also known as BDUs, this uniform is available in a variety of camouflage patterns: arctic, desert, woodland, jungle, urban, or winter. The camouflage pattern provides either a -1 step bonus to any Stealth skill checks the wearer attempts in the appropriate setting, or a +1 step penalty to an observer's Awareness skill checks to spot him. BDUs include a number of large and small pockets for holding ammo, supplies, first aid kits, or whatever the soldier needs close at hand. Item 150795001a, \$100, 3 kg

B. Uniform, service dress. Worn during office, administrative, or public-eye duties, the service dress uniform is the military version of the business suit. They're not camouflaged—white, black, blue, navy, field gray, or forest green are the most common colors. Item 150204203b, \$300, 2.5 kg

C. Uniform, formal dress. Only worn for the most exacting occasions—diplomatic receptions, commissioning ceremonies, and so on—formal dress consists of a tailed jacket and matching trousers or skirt. Almost all styles are either black or white. Item 150833590c, \$600, 2 kg

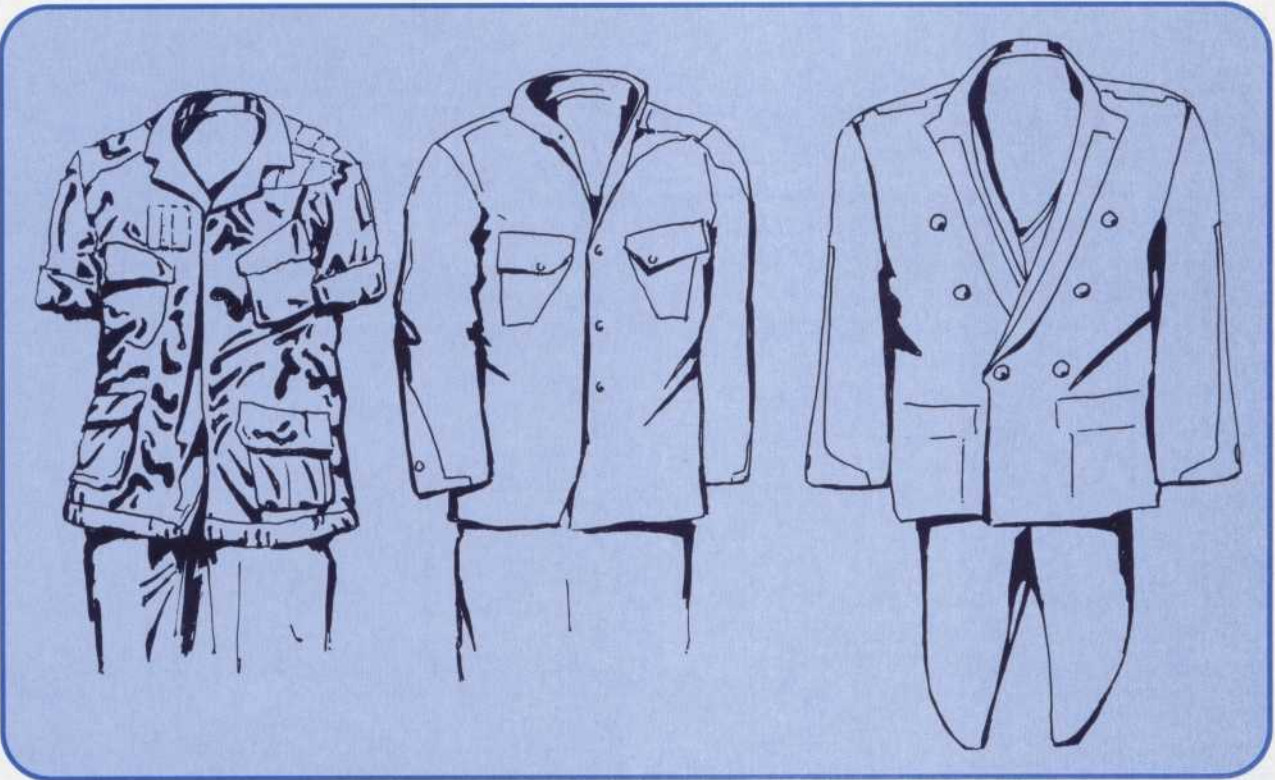

Uniforms (L-R): Battle dress, Service dress, Formal dress

THE ALIEN COLLECTION

While many of our extrasolar friends have chosen to adopt human fashions and modes of dress, we've had numerous requests for the more traditional attire of other species. In our Alien Collection, we've gathered a sampling of nonhuman clothing and accessories together for the convenience of consumers with nonhuman tastes.

ASHIELEN (FRAAL)

"Honored star-brethren, thy appearance shall be pleasantly enhanced should thou choose to purchase one of the traditional shawls of thy people. It is suitable garb for the Honored Ceremony of Contemplation, and presents a circumspect appearance when one is dealing with our star-kin, the humans."

The ashielen (aysh-ee-EH-len) is a large shoulder-drape or shawl worn for formal occasions. It is clasped in the front with a decorative brooch, and features complicated markings describing the wearer's lineage and station. Item 196233944, \$100, 0.7 kg

AYAISHE (SESHEYAN)

: In the Time of Three Darknesses Vohshey the Hunter saw that in chasing the curuy-bird it was necessary to enter the dense foliage of the dendrei-thicket : Here Vohshey's grasping talons were cut and cut again by the

dendrei-thorns : Vohshey returned to his aerie and became Mirraved the Thinker : Mirraved bethought himself of the ayaishe to cover his talons and his lower-talons : Now Beruvey the Barterer brings one ayaishe like those made by Mirraved and then worn by Vohshey : They will guard your talons from cuts :

These leather wrappings cover the forearms and lower legs of a sesheyan, creating a matching set of serviceable "gloves" and "boots." The sesheyan's talons are free to grasp and manipulate, but his skin is protected by the tough leather. The full ayaishe (ah-YAY-sheh) includes a light wrap over the leading edge of the wings and a cowl to guard the sesheyan's face. The entire ensemble provides protection equal to a leather coat: d6-3 (LI), d4-3 (HI), d4-2 (En). Item 197217434, \$200, 1.5 kg

BEISHEN (SESHEYAN)

: Beruvey the Barterer brings now the beishen-coat to warm you when Ishaimai the North Wind is upon the land: Made by Poltoitec the Crafter in the Time of Great Cold the beishen was worn by Weysh the Wanderer when first he crossed the world : It will serve you well in your travels among Cureyfi the Father of Stars :

The beishen (BEY-shen) is a loose-fitting, supple coat of fine leather with long vents through which the sesheyan's wings and tail can extend for flight. The vents can be fastened shut when the sesheyan prefers warmth over the ability to fly while wearing the coat. A detachable liner of

thick fleece makes the beishen into a serviceable winter coat, but the fleece makes it impossible to fly while wearing the coat. The beishen itself provides protection equal to a leather coat; if the beishen and ayaishe are worn together, the protective values are d6-2 (LI), d4-2 (HI), d4-1 (En). Item 197409288, *600, 1 kg

DET'SYA (T'SA)

* Please please please consider our det'sya patterns! Your scales will glitter glisten gleam like never before! Everyone you meet encounter see will know that you are a t'sa of rank privilege station! If you cannot display the det'sya tattoos paints of your clan, how will your friends enemies passersby know who you are? *

Unlike other articles in this section, the det'sya aren't an article of clothing; they're a system of ritual tattoos that boldly proclaim a t'sa's clan, profession, and personal tastes.

Det'sya patterns are sold or designed like human athletic logos or tee shirt slogans; it's up to the t'sa to find a tattoo artist capable of rendering the desired design. (T'sa det'sya artists are preferred, but many human tattoo parlors cater to expatriate t'sa.) T'sa with current det'sya patterns gain a -1 step bonus to encounter skill checks with other t'sa. The listed cost includes the pattern and the cost of application in a respectable establishment. Item 198445277, *200, 0.1 kg

GAILGHE (SESHEYAN)

: When you walk in the arms of Cureyfi the Father of Stars you encounter gardens beneath strange suns : Brighter by far than mighty Thurumi your eyes cannot tolerate these scorching skies : Beruvey the Barterer offers gailghe to shadow your eyes during times in the bright places :

Gailghe (GAYL-gheh) are protective goggles for sesheyans. The item consists of a long, thin visor that covers the sesheyan's eight eyes, held in place with an elastic strap. Gailghe (the word is a sesheyan corruption of "goggles") reduce a sesheyan's penalties for being in bright illumination by 1 step. Item 197005692, *25, 0.2 kg

GARRAUT (WEREN)

Warrior! Examine this fine garment, cut in the traditional style of our people. A handsome coat embroidered with the emblem of one's house, the garraut's cut allows one to fold the garment in a moment for battle.

A garraut is a knee-length coat consisting of no less than a dozen vertical panels, each fastened to its neighbors by simple buttons or snaps. A weren can unfasten

the coat and quickly fold the panels behind each other, baring his hide to take advantage of his natural camouflage. At best, it takes a full round to fold or unfold the garraut. Item 194291332, *150, 1 kg

NLEER NA'O (MECHALUS)

>>> Events/formal require/demand garb/suitable. Human/ (possessive) garments/formal NEGATIVE appropriate. Garments/correct <<<nleer na'o>>> available/exchangeable at address / signature shown/given below. ACTION REQUESTED <<<

The nleer na'o (neer NOW) is a formal cowled robe favored by mechalus diplomats, merchants, and leaders. The traditional version features a belled skirt that sweeps the floor, permitting no movement faster than a walk. In the last few generations, many mechalus have adopted a fashion in which the robe surrounds a small platform on which the wearer stands. A small gravity induction device in the platform allows the wearer to levitate at a speed of up to 50 kph (50 meters per phase). The powered version costs *1,500 and allows up to 24 hours of continuous use before the lanth cell is exhausted and must be recharged. Item 192377890, *300, 1 kg (5 kg w/platform)

RLIN NOCH'I (MECHALUS)

>>> Covering/useful purpose DESIGNATE work/technical business/informal domestic/comfortable. Maintenance negligible. Garments/utilitarian available/exchangeable at address/signature below. ACTION REQUESTED <<<

The everyday wear of the vast majority of mechalus, the rlin noch'i (rin NOACH-ee) is a tight-fitting bodysuit that covers the wearer to the neck. Soft-soled feet are part of the suit, so a mechalus typically wears this garment and nothing else. Climate or repellent weave and vacuum seals are very common modifications to this garment. There isn't much difference in masculine and feminine styles; mechalus don't express their sexuality in modes of dress. Item 192857222, *70, 1.5 kg

RURRKRA (WEREN)

Warrior! In battle one must be certain of one's footing. A single slip may place one at an enemy's mercy. Examine now these fine rurrkra, offering fine purchase in the most adverse conditions.

Rurrkra are traditional weren leggings and footwear, consisting of a sturdy wooden sole laced to the wearer's foot with tough braided cord. These fastenings broaden into flat, knitted strips that are wound tightly around the wearer's calf all the way to the knee. The sole is studded with small cleats, although some weren cobblers are now

using nonskid synthetic soles instead of the traditional wooden soles. Item 198209553, #80, 2 kg

SAAVAL (T'SA)

* Wait wait wait don't turn the page! You must see try buy our outstanding saaval-cloaks! Only a hatchling would decline refuse overlook our merchandise! *

T'sa fashion includes a variety of clothing styles and pieces almost as great as humanity's. The saaval is one of the more prevalent outfits, a set of loose robes that allows great freedom of movement. It slightly resembles the desert garb favored by some of Earth's Arabic cultures. The robes are gathered close at the collar, elbow, cuffs, and waist by embroidered laces. Saavals are often colorfully decorated with the owner's personal tattoos and markings. Item 198338221, #50, 1 kg

SARABEL (FRAAL)

"Honored star-friends, might we humbly offer for your inspection these excellent tunics? Sewn in the traditional style of thy people, they shall mark thee as one of the Seekers in whatsoever endeavor thou dost find thyself engaged. Wear thy heritage with pride."

The traditional fraal costume is the sarabel, a matched kilt and tunic worn with sandals or slippers and a light cloak or cape. Men wear knee-length kilts, while the skirt of a woman's sarabel may brush the floor. Fraal favor light, delicate fabrics and elegant styles; the sarabel is an outstanding example of their tastes. Item 196228735, #150, 2 kg



Sarabel

SHAANSI (T'SA)

* Look look look! Here we have show sell shaansi you must buy own wear! Everyone must have own shaansi! You will run swim leap as never before when you don wear try out our footwear! *

T'sa usually go barefoot, given their tough hides and talonlike feet, but in cold weather or rough going they'll wear a variety of shoes or slippers. Shaansi are one of

the more unusual models. Shaansi resemble sandals like humans might make, but since t'sa walk on their toes, there's room for a wide, thin blade or paddle beneath the arch of the foot. When the t'sa takes to water (not an uncommon occurrence in the marshes of their homeworld), the shaansi act like a diver's flippers, adding 2 to the t'sa's swimming movement rate. However, they don't hinder the t'sa's mobility on land. Item 198199543, #20, 0.5 kg

TILIENEN (FRAAL)

"Honored traveler, thou must cherish the comfort and style of the traditional footwear of thy people. Human shoes are heavy and clumsy, suitable perhaps for work in a mine or a factory, but these tilienen show the grace and subtlety that is the fraal. Consider them, if thou will."

Fraal who don't care for human styles still wear the tilienen, traditional slipperlike shoes that reach the mid-calf. The soft soles are perfect for tasks that require balance and grace. Item 196387004, #60, 0.5 kg

MEDICAL GEAR AND SUPPLIES

The Rigunmor Merchant Exchange is pleased to announce new distribution agreements with IsoMed Industries of Rixelia II, Gefflech Pharmaceuticals of Bonair III, and Medcare One of Delta Orionis. We're committed to bringing you competitively priced medical materials without sacrificing the top-notch quality that our customers demand. NOTE: Local legislation may bar the sale or distribution of some medical supplies. Please check with your government's medical or legal authorities before placing an order. We cannot be responsible for confiscation of delivered orders or resulting incarceration and fines.

ISO MED ARTIFICIAL BLOOD

Any combat medic can tell you that loss of blood is the number-one killer on the battlefield. Our artificial blood is suitable for transfusion into any Series I (oxygen-breathing) lifeform with a circulatory system.

Artificial blood comes as a ready-to-mix powder in a folded plastic bag. The medic simply adds one liter of common tap water to the bag and gives it a good shake (the bag has a mass of 2 kg when full). Administering artificial blood increases the amount of wound damage healed through use of the Knowledge-*first aid* or Medical Science-*treatment* skills by 1 point. Artificial blood can also be used to help stabilize a character who has sustained mortal damage; one dose provides a -2 step bonus to the victim's next Stamina-*endurance* check. to determine if mortal damage is stabilized. Only one dose

AVAILABILITY CODES

Unless otherwise noted, all items in this book are considered to have an availability of "Any." No special restrictions, licenses, or paperwork are involved in purchasing them. However, a number of items are more difficult to acquire, and are accompanied by various availability codes:

Common: Easily available, although some kind of easy-to-get license or registration may be required. A car and a house are good examples, since the buyer must fill out forms that are kept on record by local governments.

Controlled: Available only to people with special authority, affiliations, licenses, or permits. Pharmaceuticals and firearms fall into this category, since local authorities typically don't want everyone to have access to these goods. Typically, a hero can get Controlled materials by going to some trouble to meet the legal requirements.

Military: Weapons or items that are only available to authorities, corporate-sponsored teams, or individuals with extremely hard-to-get licenses fall into this category. The approval process is very likely to deny a hero a chance to purchase items in this category. Heavy weapons, unarmed military vehicles, supercomputers and AIs, and controlled technologies such as mass reactors and stardrives are good examples.

Restricted: Material and weapons of this type are not available to the private citizen. In fact, even the authorities keep these items locked up and under strict accountability. Armed military craft, government encryption devices, and the heaviest military hardware are restricted. To obtain Restricted devices or weapons, a hero must belong to an organization that can acquire these things, and she must convince her superiors that it's needed.

of artificial blood is effective for any given skill check. Each package includes six applications. Item 200050101, \$50, 0.3 kg, Common

ISO MED ARTIFICIAL SKIN

In a firefight, a combat medic doesn't have the time or training to surgically repair every injury he encounters. Artificial skin gives him the ability to quickly patch flesh wounds and minor injuries, allowing him to concentrate on life-threatening wounds while returning his comrades to the fight as quickly as possible.

The medic's best friend, artificial skin is a special adhesive bandage that can be molded and shaped to the exact contours of an injury. It's an outstanding pressure bandage that quickly brings most bleeding under control, as

well as an aseptic dressing that won't come loose or require changing under most circumstances. Artificial skin adds 1 point to the amount of damage healed by means of the first aid or treatment skills, and counts as 1 automatic success in the medic's complex skill check to heal wound damage (using Knowledge-*first aid* or Medical Science-*treatment*) or repair mortal damage (using Medical Science-*surgery*). The extra healing is cumulative with the bonus for artificial blood.

Artificial skin is made of advanced plastics, and comes in foil-wrapped strips 4 cm wide and 10 cm long. A weak alcohol solution is sufficient to dissolve the patch; any medic can prepare it from rubbing alcohol or other everyday materials. Cutting or ripping an applied patch from the patient inflicts d4-1w. Each package has six applications. Item 200070105, \$50, 0.1 kg, Common

MEDCARE ONE FIRST AID KIT

Ask any outdoorsman—a first aid kit is the first thing you need when you go walkabout. Why take chances when your life's on the line?

In the Gravity Age, first aid kits include three applications of artificial skin for cuts and abrasions, surgical thread and needles, burn dressings, antiseptic dressings, and a 3D crystal describing emergency treatments and procedures. The 3D can be played in any data slate or computer, providing a handy reference for medical emergencies. This is a better kit than the PL 4 listing in the *ALTERNITY Player's Handbook*; it provides a -2 step bonus to Knowledge-*first aid* and Medical Science-*treatment* skill checks, and allows the medic to heal d4-1 points of wound damage (minimum of 1 point) when a *first aid* complex skill check is completed, or d4 points of wound damage if *treatment* is the skill being employed. Item 210850310, \$100, 1 kg, Common

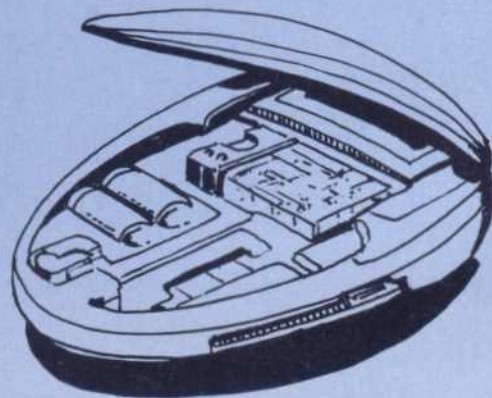

MedCare One First Aid Kit

ISO MED FORENSICS KIT

Medical examiners in over two hundred systems have chosen our IsoMed forensics kits for their professional standard. The best craftsmanship in the medical instrument industry, available now at the best price.

The forensics kit includes a laser scalpel, a powered bone saw, clamps, spreaders, syringes, and other instruments useful for conducting autopsies and drawing biological samples. Its most powerful tool is a built-in microcomputer and 3D drive, with an analysis dish that can provide gene-typing for blood, hair, and other samples on the spot (make a complex skill check with one check per round or minute). It provides a -2 step bonus to Investigate or Medical Science skill checks in forensic studies.

A kit without the microcomputer is available for \$200, but it only confers a -1 step bonus and requires hours to analyze the results. Item 220986088, \$1,200, 3 kg, Common

GRAFT, BONE

Emergency medtechs and combat surgeons don't always have the luxury of an operating theater and a comprehensive supply locker. When you can't get your patient to a hospital for reconstructive surgery, our patented bone graft allows you to rebuild broken bones with a minimum of invasive surgery.

Bone graft is a gellike substance that can be shaped and molded easily when first removed from its container, but hardens into a tough organic cement after an hour or so. It's used with an arthroscopic or syringelike applicator (available in most surgery kits) to knit broken bones in the space of an hour. As soon as the graft sets, the victim recovers full use of the limb, although the injured area typically remains sore and tender for a week or more. After 40 to 60 days, the bone graft disintegrates, having served its purpose as an internal cast and matrix for bone regrowth.

Doctors use bone graft when it's important to get an injured person up and on his feet again within a short time, instead of allowing a broken bone to knit naturally. Using bone graft in surgery counts as 1 automatic success in the Medical Science-*surgery* complex skill check, and adds 1 point to the wound or mortal damage healed by the surgeon. Item 200840200, \$500, 0.5 kg, Controlled

GRAFT, TISSUE

The sooner you can get an injured person back on his feet, the sooner the healing process can begin. Our tissue graft eliminates the need for time-consuming and delicate sutures in 63% of soft-tissue injuries. Better yet, there's no need for followup procedures to remove materials from a healed wound!

Tissue graft is similar to bone graft, but it hardens to the consistency of healthy muscle when it sets. Its smart, ergonomic materials automatically form blood vessels and muscular attachments while providing a framework for natural tissue regrowth. After 20 to 40 days, it slowly disintegrates, leaving only healthy new tissue behind.

Using tissue graft in Medical Science-*surgery* or *treatment* skill checks counts as 1 automatic success, and adds 1 point to the wound or mortal damage healed by the doctor. This is cumulative with the bonus for using bone graft, if the patient has both skeletal and soft-tissue injuries. Item 200830100, \$500, 0.3 kg, Controlled

MCI LIFE SUPPORT PACK

Seconds count when a critically injured soldier is fighting for his life. Our MedCare One life support device can buy that soldier time-time to reach the skilled surgeons and facilities he'll need to pull through.

Resembling a hard plastic breastplate with a power cell and control unit attached, the life support pack is basically a portable, self-attaching heart-and-lung machine. When applied and activated, it identifies the most convenient undamaged artery and inserts a large-diameter transfusion tube. The pack oxygenates and pumps the victim's blood as necessary, even administering painkillers, anesthesia, coagulant, plasma, or artificial blood from its onboard supplies.

When successfully activated, the life support pack negates the requirement for Stamina-*endurance* checks related to mortal damage for as long as the power holds out. (The attached cell has enough power for 12 hours.) In fact, if the pack is applied successfully within 5 rounds of the loss of the victim's last mortal point, the life support pack restores 1 point of mortal damage and preserves the victim's life.

The medic must make a successful Knowledge-*first aid* or Medical Science-*treatment* skill check in order to apply the pack and activate it. One check per round is allowed; if the victim actually lost all his mortal points, the medic's check suffers a +2 step penalty. Item 240405200, \$800, 3 kg, Military

MEDTECH ROBOT

It takes years of training to make a doctor-unless you just go out and buy one! Our medical robots are mobile ambulances, capable of preserving life and summoning help when no human medical personnel are available. Tried and tested on battlefields throughout Old Space and the Verge, the medtech robot is worth its weight in gold when you're dealing with an emergency situation! Item 292600770, \$20,500, 30 kg, Controlled

Game statistics: STR 4, DEX 6, CON 6, INT 14, WIL 7, PER 2; Durability 6/6/3; Movement-walk 4; Action

check score—15+/14/7/3; Actions per round 3; Mass 30 kg; Size 1 meter tall; Processor quality—Good (10 active slots); Stored programs—operating system, Medical Science—*medical knowledge 2*, Medical Science—*surgery*, Medical Science—*treatment 3*.

NANOSURGERY KIT

Surgeons are only human (well, in most cases they are). Even today, some surgical repairs are simply beyond their skill. With our new nanosurgery kit, no surgery is impossible. The surgeon never touches the patient—instead, he's the general of an army of nanorobots, orchestrating the most difficult surgical procedures with perfect precision and execution.

The nanosurgery kit consists of three major components: the control unit, the nanorobot storage and arming chamber, and the nanorobot injection and retrieval system. The entire assembly is housed in a tough plastic casing. The nanosurgery kit isn't intended for use as a combat surgery station; it has no provisions for anesthetizing the patient, securing his body, or monitoring his life functions. It's basically a very sophisticated scalpel.

The control unit is a top-notch desktop computer equipped with a sensor and communications package, allowing the surgeon to relay his orders to the nanorobots inside the patient. It's also slaved to microassembly lines within the storage chamber in order to produce the exact type of robots needed. Specialized sensor nanorobots act as the control unit's eyes and ears inside the patient. The nanorobots are injected into the bloodstream or lymphatic system, or delivered as an aerosol to the nasal passages or lungs. They can be retrieved through a simple blood-extraction tube.

A surgeon must have rank 5 in Medical Science—*surgery* in order to use the nanosurgery kit with best effectiveness. The kit adds a -2 step bonus to the surgeon's skill checks (only -1 if the surgeon doesn't have the right training) and allows the surgeon to heal 1 point of mortal damage and 2 points of wound damage on each success achieved during the complex skill check (instead of each two successes). Each time the kit is used to perform nanosurgery, it costs \$2,000 to replace the exotic nanotech and materials expended in the operation. Item 210995872, \$25,000, 10 kg, Restricted

IM NEURAL STIMULATOR

Death itself is no longer a barrier to the well-equipped doctor. The neural stimulator can return the spark of life to a clinically dead patient. It's a desperate measure, to be sure, but if it's the only chance you've got to save a patient, you've got to give it a try.

The neural stimulator generates thousands of microcurrent pulses of electricity in the subject's brain and

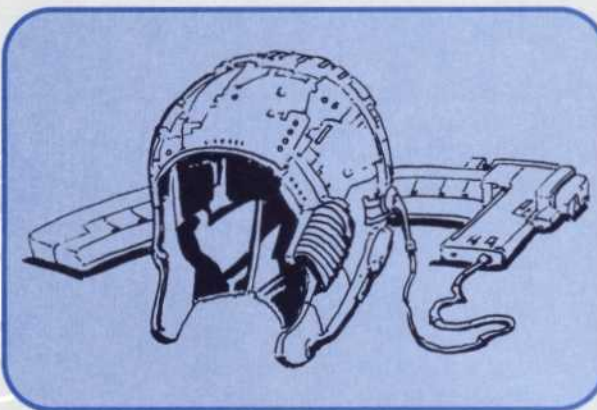

IM Neural Stimulator

spinal cord, possibly retrieving him or her from the "flat-line" of brain death. It resembles a skullcap with control and pulse nodules scattered around its perimeter. When it is applied and activated, dozens of tiny electrodes pierce the victim's skull and attempt to induce neural activity.

The neural stimulator is intended only for use on characters who have died—in game terms, characters who are out of mortal points. Applying the device successfully requires a Medical Science—*treatment* skill check; on a Good result, the doctor applies a -1 step bonus to the victim's ensuing Will feat check, and an Amazing result applies a -3 step bonus.

Once the device has been applied, the victim makes a Will feat check to return to life, regaining his last mortal point if any grade of success is achieved. A cumulative +1 step penalty applies for every 10 minutes that the victim has been dead; under the right circumstances (cold water drowning, freezing, etc.) this penalty drops to +1 per hour. Naturally, the victim is still in a bad way, and probably requires immediate and extensive medical treatment to survive. If the neural stimulator is used on a living character, the victim suffers d6s. Item 240900990, \$5,000, 0.5 kg, Restricted

PHARMACEUTICALS

The Gravity Age doctor has hundreds of wonderful tools at his disposal—weapons against disease, injury, and other health problems that earlier physicians only dreamed of. Our pharmaceutical supplies are carefully screened through the most stringent examinations to ensure your safety and health.

All the drugs described below are human-specific. Similar drugs designed to work on (or against) fraal, mechalus, seshayan, t'sa, or weren patients can be had for three to five times the listed cost. Each pharmaceutical is available in at least one of three forms—injection, spray, or capsule. Forcing an unwilling person to take one of these medicines usually requires an assistant to overpower or restrain the would-be patient. If the victim is free to resist, the medic must make a successful Unarmed

Attack skill check in order to deliver the substance. The spray is easy to deliver (no attack penalty) but provides the victim with a -2 step bonus to any check he makes to avoid the drug's effects, since the dose is dispersed. The injection, on the other hand, is hard to administer (+2 step penalty to the Unarmed Attack skill check), but delivers a concentrated dose, providing no bonus to the subject's Constitution or Will feat check to resist.

Identifying the condition of the patient, measuring the right dosage, and correctly applying any of the pharmaceuticals or supplies below requires a Medical Science-*treatment* skill check. (A character without this specialty skill must make an untrained skill check to get it right.) If this fails, the pharmaceutical won't be effective when applied. If the administering character rolls a Critical Failure, he might aggravate the subject's condition in some way.

A. Analgesic. Painkillers offset the penalties from mortal or excessive wound damage. (See the description of the Stamina-*resist pain* skill in Chapter 4 of the *ALTERNITY Player's Handbook*.) The patient must make a Will feat check. On a Good or Amazing success, he ignores 3 steps of pain-related penalties; on an Ordinary success, 2 steps; and on a Marginal success, 1 step. The painkiller dose lasts for 4 hours. A character can be heavily dosed, taking a second analgesic while the first one is still in effect, but he automatically takes a +1 step penalty to all actions due to numbness and disorientation. However, the additional dose may help enough to make it worthwhile. Item 250100344a, \$10/dose, Controlled

B. Anesthetic. A dose of anesthetic knocks out any willing character for a specified time of up to 12 hours. The administering physician is allowed a Medical Science-*treatment* check to see how well he times the length of unconsciousness (on a Failure, the victim awakes d4 hours earlier or later than the target time). Against an unwilling character, the administering physician must succeed on an Unarmed Attack skill check. The victim must succeed on a Constitution feat check to resist knockout: Failure: knockout; Ordinary: 2d4+2s; Good: d6+1s; Amazing: d4s. Item 250110677b, \$50/dose, Controlled

C. Antibiotic. This broad-spectrum agent fights bacterial and viral infections of all kinds. A complete regimen requires d4 days of continued dosage and provides the recipient with a -4 step bonus to his Constitution feat checks in order to fight off the disease. Item 250115119c, \$50/dose, Controlled

D. Antiradiation Serum. Few treatments are effective against radiation sickness, but this serum is one of them. Its electrolyte solution helps to stabilize damaged cells in the bone marrow and gastrointestinal tract, the tissues most vulnerable to radiation damage. Antiradiation serum comes in 1 liter bags for intravenous administration. When treated, the victim gains a -2 step bonus to his

Constitution feat checks against that episode of radiation sickness. Item 250505290d, \$100/dose, Controlled

E. Antivenom. Countering the effects of natural poisons, antivenom provides the stricken character with a -4 step bonus to his Constitution feat check against the poison if administered during the onset time, or a -2 step bonus if administered while the poison is inflicting damage on the victim. Specific antivenoms—for example, against timber rattler bites, box jelly stings, stonefish venom, and so forth.—are even more effective, improving the bonus to -6 and -4 respectively, but they're useless against other types of natural poisons. The purchaser must decide if he wants the increased effectiveness of the specific agent, or the usefulness of the general antivenom. Item 250307188e, \$100/dose, Controlled

F. Coagulant. Easily administered with a simple Knowledge-*first aid* check, coagulant induces artificial clotting at the point of injury, drastically slowing bleeding. A dose gives the victim a -3 step bonus to any Stamina-*endurance* checks he attempts in the next ten minutes. More than two doses in the course of an hour are risky; the victim must succeed on a Constitution feat check or go into cardiac arrest from the thickening of his blood. Item 250490475f, \$50/dose, Controlled

G. Immunization Booster. The best way to survive a disease is to not get sick in the first place. An immunization booster "tunes" the recipient's immune system to the common ailments of a particular setting or world, providing him with a -2 step bonus to any Constitution feat checks he attempts to resist catching those diseases. The booster's effects last for one year. Item 250806991g, \$50, Controlled

H. Psi-enhancer. Using mental powers takes a great toll on a mindwalker, but modern medical technology provides a solution to this problem. The psi-enhancer restores 2d4 lost psionic energy points when ingested. Unfortunately, the distracting side-effects of the serum provide a +1 step penalty to a hero's psionic skill checks for the next d6 hours. Item 250996149h, \$150/dose, Controlled

I. Psychoactive Booster. Deadening the mindwalker's physical sensations and detaching his awareness from the world without, this booster provides a -2 step bonus to the use of all psionic skills for the next 2d4 hours. The recipient also gains d4 temporary psionic energy points, which are expended before his own points when he uses psionic talents.

The downside is simple: For the next 4d4 hours, the victim suffers a +3 step penalty to all nonpsionic skill checks, feat checks, and other activities. If the psychoactive booster is administered more than once in a single 24-hour period, the victim must attempt a Resolve-*mental resolve* skill check. If he fails, he permanently loses 1 point of Intelligence, Will, or Personality (randomly deter-

mine affected ability.) Item 250996844i, \$250/dose, Restricted

J. Sedative. Used to control dangerously violent people or animals, sedative can be applied by injection, aerosol spray, or pill. The recipient of a dose of sedative suffers a +4 step penalty to all actions, and must succeed on a Will feat check to force himself into energetic, violent, or demanding tasks. The victim may attempt a Constitution feat check to reduce the effect—on an Ordinary success, the penalty is reduced to +3; Good, +2; and Amazing, +1. A dose of sedative lasts for d4+1 hours before it begins to fade, losing 1 step of effectiveness per hour. Item 250306884j, \$25/dose, Controlled

K. Stimulant. This shot counters fatigue and stun damage. When a character receives a dose, he makes a Constitution feat check with the following results (heroes with weak Constitutions are more likely to be affected by drugs, so the better the success, the less effect the stimulant has): Failure: 12 points; Ordinary: 9 points; Good: 6 points; Amazing: 3 points. This damage is removed first from fatigue damage, and any "leftover" effect is then applied to any stun damage the recipient possesses. After 2d4 hours the stimulant wears off. The subject sustains half the fatigue damage previously alleviated by the injection. (Note that the stimulants available at PL 7 are more powerful and less dangerous than the stimulants described in the *ALTERNITY Player's Handbook*.)

Using a stimulant more than once per 24 hours is dangerous. If a character does so, he suffers a +1 step penalty to all mental abilities and skill checks, and suffers d6–3 wound points of damage. Item 250733004k, \$25/dose, Common

L. Tranquilizer. When you need to knock someone or something out altogether, a tranquilizer is the tool for the job. The subject is allowed a Constitution feat check at a +2 step penalty to resist its effects: On a Failure, he's knocked out; Ordinary, he sustains d6+1 points of fatigue damage; Good, d4 points of fatigue damage; Amazing, d4–1 fatigue points. The effects last for d6 hours. Item 250388037L, \$40/dose, Controlled

STRETCHER, ALL-TERRAIN

Rough terrain can make even minor injuries serious by making it impossible to get the victim to help. Our powered all-terrain stretcher can save time—and lives—in the baddest badlands.

One of the best pieces of rescue gear around, the AT stretcher consists of a taut nylon web between two telescoping sponsons, married at the midpoint by a power module containing a small grav inducer. The whole thing stows as a pack 40 cm tall, 30 cm wide, and 10 cm thick for easy transport to the injured person's site.

When unfolded and activated, the stretcher levitates about a meter from the ground, supporting up to 250 kg

of mass. A handheld control unit is connected to the power module by a 50-meter cable, allowing one person to easily direct the motion of the stretcher. The operator can even direct the stretcher to ascend or descend cliff-sides, cross chasms, etc., while remaining perfectly level and still. Naturally, safety straps are included to secure the patient. The lanthanide cells in the stretcher provide up to 24 hours of continuous operation at maximum capacity. Item 275833206, \$500, 10 kg, Common

TIMEOUT STASIS STRETCHER

When a medical emergency is completely beyond your ability to cope with it, the stasis stretcher provides a life-saving timeout. Simply activate the Qwik-Freeze™ stasis bag and put the patient on ice until you can get him to someone who knows what he's doing!

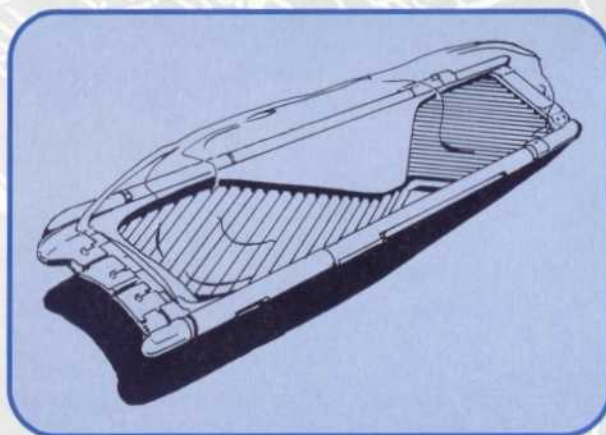

TimeOut Stasis Stretcher

The stasis stretcher has the induction motor and control features of the all-terrain stretcher, but it includes one additional feature: an emergency freeze system designed to suspend the victim's animation in a matter of moments. A soft plastic cover is built into the stretcher sponson and can be deployed to quickly seal the patient inside. This bag is then filled with cryogenic suspension gases, freezing the subject in his current condition. Unlike the AT stretcher, the stasis stretcher doesn't fold up into a pack—it's 2 meters long, 60 cm wide, and about 30 cm thick when the bag is deployed.

Awakening a suspended patient requires a Medical Science—*treatment* skill check in any modern medical facility of Good or better quality. Of course, he'll be in the same condition he was when he was frozen. Item 275137658, \$2,500, 15 kg, Controlled

SURGICAL KIT

Disaster can strike anywhere. You might not always have the luxury of a full medical facility to operate on injured people. With our surgical kit, you've got all the tools you need to help people anywhere.

The surgical kit contains laser scalpels, a vital-signs monitoring system, an anesthesia bottle and control system, antiseptics, portable lighting, and an assortment of other high-tech instruments, providing a surgeon with all the tools he needs to practice his art. The doctor still needs a quiet place where he can work on the patient—the cleaner, the better, although the antiseptic sprays included in the kit can keep the instruments and patient free of infectious microorganisms if used with care. The entire kit stows into a tough plastic case the size of a standard backpack.

The surgical kit is considered a Marginal medical facility if used in the field (no modifier to Medical Science—*surgery* skill checks), or an Ordinary facility (-1 step bonus to *surgery* skill checks) if the doctor can find a sheltered building or vehicle with power and water. Performing an operation with the kit expends supplies worth \$250, which must be replaced before the kit can be used again. Item 240855938, \$1,250, 12 kg, Controlled

TRAUMA PACK I

Why leave anything to chance? The trauma pack is a medic in a box, capable of handling the most serious combat injuries. Best yet, its "fire and forget" technology allows a soldier to apply one to a wounded comrade and get back to the fight, confident that his buddy's going to make it.

The trauma pack is armed with microinjectors and tiny stores of various medical supplies. It provides a -2 step bonus to the user's Knowledge—*first aid* skill check, or a -3 step bonus to Medical Science—*treatment* skill checks. Better yet, the onboard computer's assist program allows characters untrained in *first aid* to check as if they had a skill of *first aid* 3. Finally, if the trauma pack is positioned over the site of the injury and set to automatic mode, it can use Medical Science—*treatment* on fallen heroes with an effective skill score of 12. Trauma packs can be used in the following modes:

- **Heal stun damage:** A single skill check restores 2/3/4 stun points to the victim, depending on the medic's success.
- **Recover consciousness:** A single skill check awakens an unconscious victim and restores 2/3/4 stun points. If the victim was knocked out through loss of all his wound points, he regains 1 wound point.
- **Heal wound damage:** With two consecutive successful skill checks, the trauma pack heals 4 wound points of damage.

- **Staunch mortal damage:** With a successful skill check, a mortally injured character is stabilized and need not make Stamina—*endurance* checks related to mortal damage for the duration of the scene.

The trauma pack measures 20 cm × 10 cm × 2 cm. It contains supplies for six applications, after which it must be refilled at a cost of \$100. Item 210555765, \$200, 1 kg, Common

TRAUMA PACK II

What's the use of carrying a trauma pack if you're too badly hurt to apply it? The advanced model of this life-saver is a feature of body tank armor and is also available as a cybernetic attachment.

The trauma pack II continuously monitors the wearer's vital signs and responds instantly to a variety of injuries.

- **Knockout:** When the wearer loses all his stun points, the pack injects him with stimulants and painkillers to immediately return half his full normal allotment of stun points (round up). The victim has a +2 step penalty to all actions in the following round due to grogginess.

- **Heal wounds:** When the wearer loses more than half his wound points, the pack's automedic features immediately restore d4+2 lost wound points.

- **Mortal damage:** The trauma pack automatically staunches any mortal damage, negating the need for Stamina—*endurance* checks. However, the subject suffers a +3 step penalty to all actions until the end of the scene, and then suffers the normal penalty based on the amount of mortal damage he's received.

Each trauma pack contains materials and supplies for two uses of each function. A single character can't wear more than one trauma pack at a time, but he could carry additional packs and plug them in when the active pack has run out of supplies. It takes about five minutes to change trauma packs. Item 255900344, \$400, 2 kg, Controlled

WALKER, MEDICAL

Wheelchairs are awkward and uncomfortable, even with modern gravity induction technology. Our medical walker allows a patient full mobility while recovering from the most serious injuries, and can even be concealed beneath most normal clothes. Don't let a serious accident change your lifestyle!

The medical walker consists of a pair of powered leg braces and lower back support unit. It provides a conscious wearer with the ability to walk at up to 6 meters per phase, regardless of his physical condition. Even characters temporarily paralyzed by spinal injuries can walk with the aid of a medical walker. Not recommended for patients whose legs should be immobilized due to fractures. Item 285290662, \$1,500, 10 kg, Common

PROFESSIONAL EQUIPMENT

Give a top-notch craftsman top-notch tools, and you can't go wrong. You provide the know-how; we'll provide the materials. These kits, supplies, and implements are everything you'll need to get the job done and get it done right!

TyKo CARBIDE SHEARS

Made from the toughest cutting surface known, our carbide shears can sever tungsten bars up to 4 cm in diameter with the built-in PowerAid™ piston.

High-tech bolt cutters, carbide shears have a cutting surface 6 cm long mounted on 45 cm handles. The handle structure includes a small hydraulic piston and accumulator that can store extra energy for powered cuts. Carbide shears automatically sever objects of Good or Ordinary toughness, and allow the user to sever objects of Amazing toughness with a successful Strength feat check or Technical Science—*repair* skill check. They're useless in combat, since the target would have to be motionless for the shear-wielder to use it as a weapon. Item 300322831, \$100, 3 kg, Common

DEMOLITION GEAR

Nothing beats high explosive for rearranging the landscape to your taste. Our standard demolition pack costs \$750 and includes two Detonex charges, 50 meters of detcord, four spike caps, two command detonators, and two timers.

A. Casing, magnetic. A convenient tool for fixing explosives to metallic surfaces, magnetic casings are available in block and satchel sizes. After it is attached, it clings to the appropriate surface with an effective Strength of 16 (block size) or 18 (satchel size). Item 310105878a, \$100, 0.3 kg, Controlled

B. Casing, serrated. Surrounding a charge with a casing designed to fragment is a good way to enhance its antipersonnel capabilities. This reduces the firepower of the blast by one category, but adds 2 points to the charge's damage ratings, and increases the respective areas of effect by 50%. For instance, a satchel charge of plastic explosive normally inflicts 3d4+2w in a 2-meter radius, 2d4+1w in a 4-meter radius, and d6-1w in an 8-meter radius. With a serrated casing, the firepower drops to Ordinary, but the damage and range increase to 3d4+6w out to 3 meters, 2d4+3w to 6 meters, and d6+1w out to 12 meters—a much deadlier weapon against lightly armored targets. Item 310205455b, \$50, 0.2 kg, Controlled

C. Charge, block. A block of explosive is designed to damage a very specific target—blasting a hole in a wall, opening a door, sabotaging a piece of machinery, etc. Block explosives are about 25 cm × 12 cm × 5 cm and weigh 1 kg each. Using multiple blocks at the same time

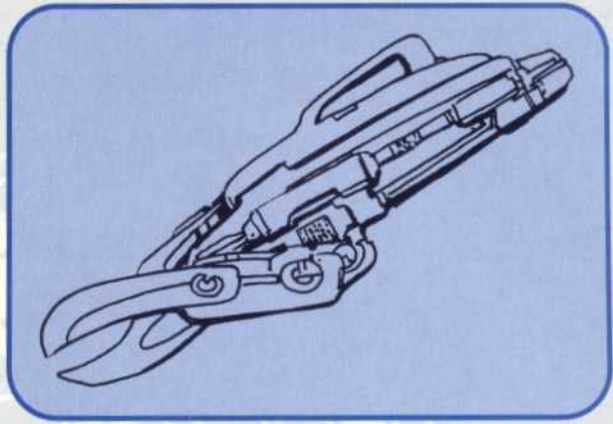

TyKo Carbide Shears

adds +1 point of damage and +0.3 meters to the radius of effect per additional block, up to a maximum of 6 extra blocks (after that, treat it like a satchel charge).

See the box on the next page for a description of available explosives. Item 310900840c, price varies, 1 kg, Controlled or Restricted

D. Charge, satchel. Satchel charges are meant to accomplish large-scale demolition, knocking down major structures. Each weighs 10 kg and is about 30 × 20 × 10 cm in size. Multiple charges don't increase the damage inflicted, but may increase the area of effect if they're dispersed around the target. Each charge beyond the first applies a +1 step penalty to the structure's durability check to avoid destruction. The available explosives are described in the box on the next page. Item 310800370d, price varies, 10 kg, Controlled

E. Detcord. Also known as primercord, detcord is a plastic explosive that comes in long rolls that are easily molded to any surface. Detcord can be used as a "fuse," linking other explosive charges, or it can be used as the main charge. Each meter of detcord inflicts d4-1 wound points of Ordinary damage to an object it's in direct contact with, up to a maximum of 6d4-6 wounds; additional detcord doesn't improve the damage any more than that. Detcord has no real area of effect. Item 310700385e, \$25/meter, 1 kg/10 meters, Controlled

F. Detonator, fused. Any explosive charge needs a detonator of some kind—a device that delivers a priming charge or electrical shock to cause the detonation of the main charge. The fused detonator is a device set off by specific conditions. Commonly used detonators include:

Contact: Anything that touches an attached pressure plate causes the detonator to fire.

Electric Eye: The detonator fires when an electric eye beam is broken by the passage of a person or object.

Inertial: The detonator fires when it (or the object it's attached to) moves.

Magnetic: The detonator fires when a significant amount of ferrous metal approaches within a distance of 10 meters.

GRAVITY AGE EXPLOSIVES

While there are virtually hundreds of different explosives in use throughout the stellar nations, the great majority have very similar properties. Here are five of the most common explosives heroes might encounter.

Detonex™: The all-purpose plastic explosive of the 26th century, Detonex can be molded to fit any surface. Block #200, satchel #500; Controlled

Matter charge: This potent device is a mass reactor bomb, using dark matter decay to create an intense burst of energy. Satchel #2,500; Controlled

Nuclear charge: Available only in the darkest black markets, the Gravity Age nuke is a small, efficient fusion device. Anything within 400 meters of its detonation point is gone. Objects 400 to 1,000 meters away sustain 2d8w, and targets 1 to 2 kilometers distant suffer d12w. #500,000 and up; Restricted

Plasma jelly: This electrochemical mix flashes to white-hot plasma when detonated, creating a scorching fireball. It's more damaging than Detonex, but more expensive. Block #500, satchel #1,500; Controlled

Pyrenex™: An advanced incendiary, Pyrenex creates horrible firestorms when detonated. Anything within the area of effect is almost certain to catch fire after the blast. Block #600, satchel #1,800; Controlled

Block charges

Explosive	Type	AoE	Damage
Detonex	LI/G	c/1/2	d6+1w/d4w/d8s
Plasma jelly	En/G	c/1/2	d4m/d6+1w/d4+1w
Pyrenex	En/G	c/1/3	2d4w/d6+1w/d4w

Satchel charges

Explosive	Type	AoE	Damage
Detonex	LI/A	4/8/12	2d4m/2d6w/d8-1w
Matter	En/A	6/10/16	d4+4m/d6+2m/d12w
Nuclear	En/A	see above	see above
Plasma	En/A	c/4/10	2d4+1m/d6+1m/2d4w
Pyrenex	En/A	4/8/12	3d8w/2d8w/d8w

Proximity: The approach of an object of a minimum speed or size sets off the charge. Proximity fuses could be set to react to the approach of a vehicle moving at more than 20 kph, a person moving at a walking pace, etc.

Thermal: The charge detonates when the fuse detects a change in temperature.

Dozens of other variations are possible. Item 310500690f, #50, 0.5 kg, Controlled

G. Detonator, command. Since the conditions activating a fused detonator may not occur, it's common to rig command detonators for most jobs. A command detonator allows the demolitions engineer to fire the detonators remotely when he's ready. Two common models are

available: radio and wire detonators. Radio detonators transmit a radio signal, but can be jammed or intercepted. Wire leads can be tangled or pulled loose. Item 310550245g, #25, 0.5 kg, Controlled

H. Sequencer box. This device is a radio and wire signal switchbox that allows the demolitions expert to specify exactly the order in which multiple command-detonated charges at different sites will detonate. Multiple charges controlled by a sequencer box add a +2 step penalty to the target structure's durability check to resist destruction through demolitions charges, or a -2 step bonus to the user's Demolitions skill check if you prefer to use the basic skill mechanic. Item 310040788h, #200, 3 kg, Common

I. Spike cap. The smallest and simplest explosive charge available, the spike cap looks like a railroad spike or splitting wedge. Driven into a seam or corner and activated by a safety switch, the cap allows 10 seconds for the character to get clear and then detonates. It inflicts d6+1w of Good damage to the object it's inserted in (add +1 point per additional spike cap if more than one are used simultaneously). The device is so simple that no skill check is needed to apply it. Item 310920405i, #50, 0.5 kg, Controlled

J. Timer. The last type of detonator available, the timer simply allows the demolitions rigger to specify a countdown or set time for the charge to fire. It can be coupled with a fuse device to provide a countdown after some other condition has been met. Item 310520500j, #10, 0.5 kg, Controlled

BERTEK EXCAVATION PROJECTOR

The days of backbreaking labor are over! Equip your team with our projectors, and every man's got the digging power of a ten-ton bulldozer on his back.

A derivative of the render rifle's gravitonic technology, an excavation projector is a handheld digging and lifting device. A heavy backpack contains the projector's lanthanide cells and graviton generation device, while the user directs a gunlike nozzle at his target. Ten minutes of work in excavation mode displaces 5 cubic meters of sand or soft earth, 2 cubic meters of hard-packed earth or clay, 1 cubic meter of soft or porous stone, or 0.5 cubic meter of hard stone. In push mode, the projector can move up to 500 kg of material at a rate of 2 meters per phase. Typically, a projector operator toggles back and forth between modes several times a minute to break up material and then move it out of the way.

Four hours of heavy work or eight hours of light or intermittent work exhaust the projector's lanthanide cells. Item 340677839, #1,000, 20 kg, Common

TYKO HEAVY-DUTY FAN

This isn't an office cooling fan, friend. This is an industrial strength air mover, capable of dispersing a building-full of fumes or smoke in a matter of moments.

Powered by built-in lantn cells with an endurance of 2 hours, the heavy duty fan moves 2,000 cubic meters of air per minute. This is sufficient to completely refresh the atmosphere in a space 20 meters wide, 25 meters long, and 4 meters tall. Naturally, there has to be a place to draw air from and to discharge air to—setting up the fan in an enclosed space creates a lot of noise and wind but just pushes around the air that's already inside. Thirty meters of collapsible plastic tubing is included to extend the fan's reach or draw. Item 340879003, \$150, 30 kg

GENERAL INDUSTRIES FLOODLIGHT

Why work in the dark? Our multiband floodlights let you throw the illumination of your choice on the job at hand. You'll wonder how you got along without 'em.

This arc-light has adjustments for color (infrared through ultraviolet), pattern (wide flood or narrow search beam) and intensity. As a beam, the floodlight can illuminate a 10-meter circle up to 2 kilometers distant. As a lamp, the floodlight illuminates a cone-shaped area 100 meters wide and 250 meters long. Its lantn cells have an endurance of 12 hours at maximum power. The adjustable stand allows the light to be positioned in a number of ways. Item 340297939, \$75, 8 kg

GENERATOR, FUSION

You'll never have to worry about power needs again with your own fusion generator. Just add water every now and then, and watch the kilowatts roll in!

The smallest fusion plant possible with the technology of the day, the generator is about 1.5 meters tall and roughly half that size in diameter. It provides enough energy to run a large building or small complex of about 100 people, a powerful vehicle such as a skytank or submersible, or power many systems of shipboard quality. In fact, it produces 1 energy point and requires 2 durability points as a ship system, although larger fusion generators are more commonly used. The generator is designed to be virtually foolproof, and shuts down safely in almost all catastrophic failures.

While the generator only needs water to run once it's operational, it takes a source of energy to cold-start it. A 10-kg lanthanide start-cell is included in purchase; the user's manual recommends immediately recharging this battery, in case the generator must be shut down and restarted cold at some later time. Item 360295880, \$8,000, 120 kg, Common

BERTEK PORTABLE GENERATOR

Okay, so a fusion generator is too big for the job you have in mind—try a portable generator for your power needs! Light and efficient, you can take our portable generator anywhere!

The portable generator's something of a throwback, relying on a highly concentrated self-oxygenating liquid fuel. It produces enough power to run a small building or outpost of about ten people or to power one average-sized piece of equipment. It uses one liter of Oxymite™ fuel per two hours of operation; the listed cost and mass includes a 10-liter tank full of Oxymite. Additional fuel costs \$10 and weighs 2 kg per liter. Item 260135200, \$500, 25 kg

TRAILTECH SOLAR GENERATOR

You need power, but you don't want to haul bulky fuel cans around? The solar generator needs nothing but sunlight and space to meet your power needs.

The solar generator can only power small equipment or a camp of about five people, but it's light and it doesn't need fuel. For best results, its collapsible panels must be laid out over an area of about 20 square meters, preferably in a sunny spot. Item 260335400, \$750, 15 kg

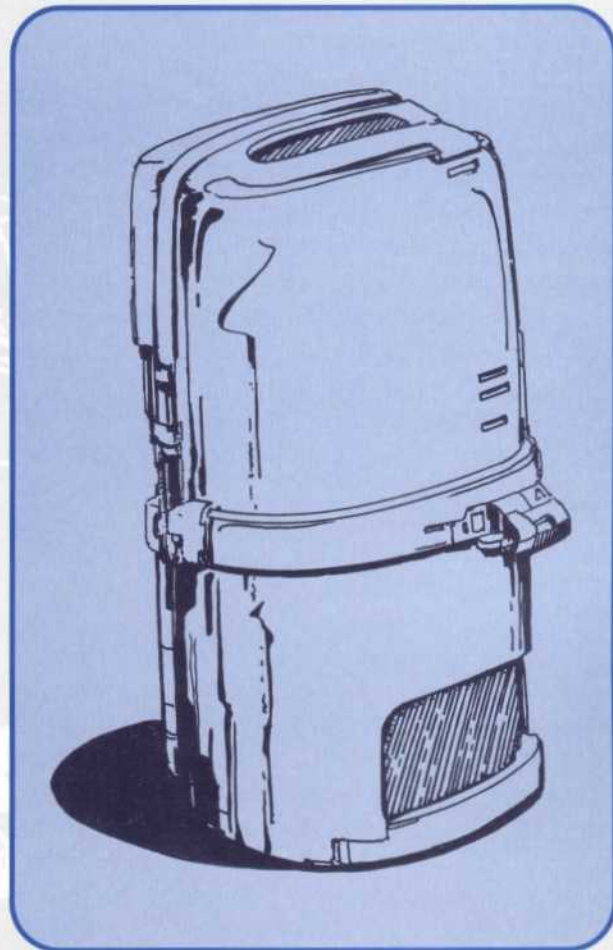

Fusion Generator

GENERAL INDUSTRIES INDUCTION DISK

The Gravity Age stepladder, our induction disks provide you with a stable platform for elevated work.

An induction disk is about 40 cm in diameter and roughly 10 cm thick. It contains an induction motor and a powerful lantth cell, controlled by a handheld wired remote. A safety line is included for high work—should the operator fall off the disk, he ends up hanging just below it, and can easily lower himself to the ground. The disk can move in any direction at a top speed of 6 meters per phase, and can support a mass of up to 200 kg for 2 hours before it requires recharging. The disk has no altitude limit, but sounds a warning beep when its charge is low. Item 370409561, \$600, 10 kg

INSTRUMENT PACKS

Just like a craftsman, a scientist relies on tools to extend his senses and record his observations. Our instrument packs provide high-quality devices in a portable and efficient package. Don't do field work without one!

All of the packs described below provide a -1 step bonus to a hero's skill checks in the appropriate area when he's out in the field. In addition, complex skills are simplified by the pack instruments, decreasing by one degree of complexity (Amazing to Good, etc.) This reduces the number of successes a hero needs to complete a complex skill check to the next lowest range. In addition, all packs include some specialized instruments and tools that may have other applications for ingenious heroes.

A. Biology Pack. The biology pack includes both micro- and macrobiological tools. Sampling dishes and slides, scalpels and tweezers for dissection, and a small microscope are included for microbiological study. Binoculars, camera, an air rifle with six tranquilizer darts, and a tag gun are provided for studying animals. The air rifle has a range of 10/20/40 meters and can fire one dart per round. Item 350155895a, \$800, 12 kg, Controlled

B. Chemistry Pack. The most important part of the chemistry pack is an analyzer kit capable of identifying unknown compounds by testing their reactions against certain reagents. A connected "sniffer" allows the operator to sample any object touched. A burner, agitator, and centrifuge plus a collection of durable nonreactive vials, beakers, and flasks allows the chemist to set up a small lab in the field. Item 350255879b, \$700, 8 kg, Common

C. Physics Pack. The main components of the physics pack are a broad-band EM receiver for detecting and recording radio emissions, a neutrino detector, a multi-purpose radiation sniffer, and a handheld mass detector. Other implements include a laser rangefinder, a small spectrolyzer for analyzing the temperature and composi-

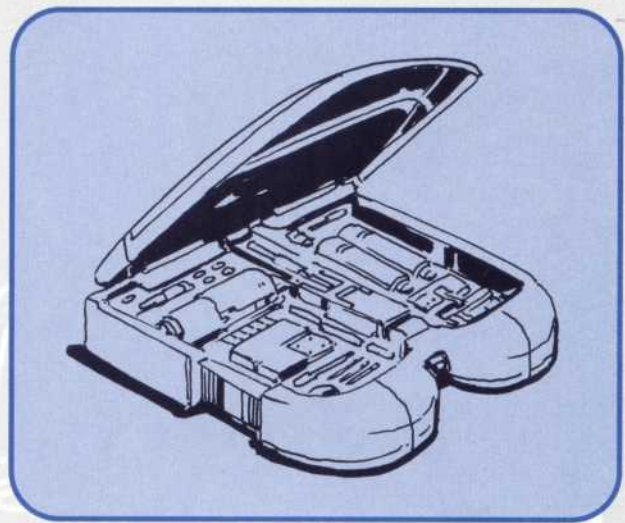

Planetology Instrument Pack

tion of distant objects, and a small electron microscope. Item 3503558006c, \$2,500, 15 kg, Common

D. Planetology Pack. An all-purpose kit combining geology, chemistry, and astronomical instruments, the planetology pack includes: an atmospheric sniffer; soil and water test kits; seismic detectors and ground sonar measuring devices for analyzing local geological characteristics; an electronic sextant for making celestial observations; and a laser rangefinding device for cartographic measurements. Item 350455297d, \$600, 10 kg

E. Xenology Pack. Specialized for the study of alien lifeforms, the xenology pack contains the following instruments: an air rifle with six tranquilizer darts; a tag gun; a 4-meter-square net; binoculars; a vidcam with a telephoto lens and parabolic mike; and a handheld resonating imager for taking pictures of a creature's internal structure. Item 350555766e, \$1,200, 15 kg, Controlled

BERTEK POWERED JAWS

Making a car or building into a pile of twisted wreckage is easy—but how about taking it apart to help the people inside? The powered jaws are a lifesaver when time isn't on your side.

This heavy tool is designed to pry open jammed doors, access panels, or wreckage. It automatically defeats wreckage or materials of Ordinary and Good toughness; the operator must make a Technical Science—repair skill check to successfully pry open wreckage of Amazing toughness. In reverse, the jaws can snip pieces of debris up to 10 cm thick. Item 300557849, \$300, 15 kg

LAUNCH FACILITY, PORTABLE

Nothing beats a satellite for giving you a bird's-eye view of the situation. Set up your own orbital command link and surveillance system in less than twenty minutes!

The portable launch facility consists of sectioned metal

gridwork for a launch pad, a radio transceiver and uplink for communications with the satellites, a desktop computer to manage things, and a robot orbiter—a small space-capable booster capable of lifting a satellite weighing 100 kg into orbit. The orbiter itself is a collapsible saucer-shaped vehicle powered by induction motors and an onboard fusion generator. At 250 kg, it's the biggest piece of the facility, and it breaks down into twelve smaller pieces for easier transport. The other components weigh an additional 150 kg, and the whole thing can be transported in a good-sized jeep, skycar, or by six men on foot. Setting up the facility for launch is a complex skill check using System Operation or Technical Science, requiring three successes (one check per five minutes).

Satellites aren't included with the facility. Some of the models available include:

Commsat: The commsat provides orbital communications to any point in the hemisphere over which it's passing. Three commsats can create continuous coverage over a whole planet. Each sat weighs 50 kg and costs \$5,000.

Defsat: The defsat can engage space vessels in orbit. It's a flying mine armed with any missile warhead, destroying itself in the attack. It weighs 100 kg and costs \$10,000 (specialized warheads may be much more expensive).

Spysat: The spysat offers continuous surveillance of the planet below with its powerful cameras. It can detect human-sized figures in a path 10 kilometers wide. It takes thirty spysats to set up a pattern that can sweep every point on the planet's surface once per day. Each weighs 100 kg and costs \$15,000.

Weathersat: The weathersat monitors atmospheric conditions and provides invaluable data for forecasting local and planetary weather. Six can create a network that provides a meteorologist with significant new data at 6-hour intervals. Each weighs 50 kg and costs \$5,000.

Item 390100100, \$12,000 base cost, 400 kg base mass, Controlled

BERTEK LASER TORCH

Nothing beats the cutting power of a high-intensity laser beam. Steel runs like water when you put this little beauty to work!

By means of a special focusing ring, the torch-user can vary the cutting length of the beam with a simple dial. Beyond the set focus distance, the laser beam rapidly disperses into harmless light. The torch's lantl cells and lasing mechanism are worn in a backpack, connected by fiber-optic line to a pistol-grip.

The laser torch can handle cuts up to 30 cm deep in materials of Ordinary, Good, or Amazing toughness. A cut 1 meter in length takes about 1 round per centimeter of depth, so cutting a 1 m × 1 m hole in a wall 5 cm thick

takes 20 rounds. The torch's batteries have an endurance of 30 minutes (150 rounds) of heavy cutting. If the torch is employed as a weapon, the welder must take a +3 step penalty on his or her attack skill check. If the torch hits, it inflicts damage equal to a chainsword (d8+1w/d8+2w/d4+1m, but this damage is type En/A). Item 300397544, \$750, 10 kg, Common

BERTEK PUMP, PORTABLE

Got water in one place when you need it someplace else? A portable pump sure beats a bucket brigade!

Using the same kind of combustion engine that drives a portable generator, the pump has a capacity of 2,000 liters per minute with a level transfer. Pumping against Earth-normal gravity reduces the capacity by 100 liters per minute per meter of lift. The portable pump can run for an hour on a liter of Oxymite™ fuel; a full 10-liter tank is included with the pump. Additional fuel costs \$10 and 2 kg per liter. Item 340658577, \$250, 30 kg

RPV Kit

When you need a bird's-eye view but you can't get a manned aircraft into the sky, a remote-piloted vehicle (RPV) may be just the compromise you're looking for. Don't wonder about what's over the next hill—send your drone to take a look!

This useful kit consists of three major components: two RPVs and a control console. Each RPV is a small aircraft powered by an induction engine, armed with vidcam and sensor pickups that continuously transmit back to the display unit. The RPVs are about 1 meter long with a mass of 15 kg each, and the control unit is about the size of a desktop computer and masses 8 kg—the RPV kit is easily transportable by one person.

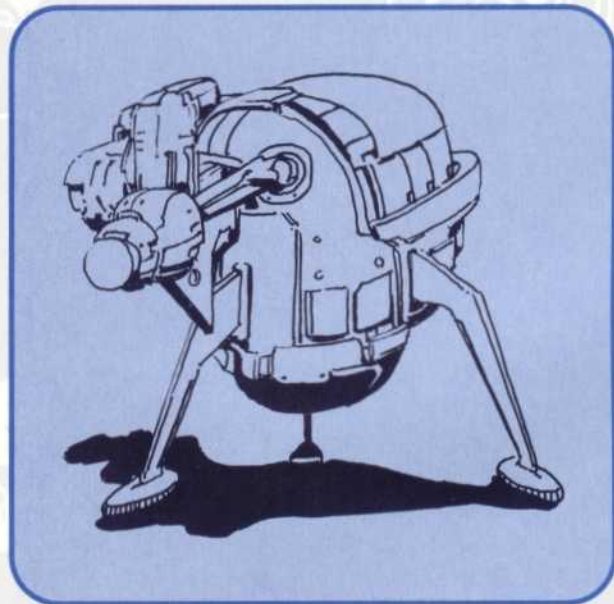

RPV (Remote-Piloted Vehicle)

Since the RPVs are powered by induction motors, they're silent and quick, capable of hovering or maneuvering in very restricted spaces. They can travel at a maximum speed of 300 kph, and their transmitters can relay data from as far as 50 km distant in good conditions. The standard sensors are a video system with a 120-degree field of view and up to 10× magnification on command, and a thermal imager that can detect heat emissions and signatures within 1,000 meters of the RPV. The RPV's lantn cells allow flights of up to 2 hours in duration.

Some black-market entrepreneurs have fitted RPVs with weapon systems; the probe can carry payloads of up to 5 kg. Controlling the RPV involves use of the System Operation—*sensors* skill. Item 390105476, \$4,000, 40 kg, Controlled

TRAILTECH RESCUE PACK

Not sure what it is you'll need for the job at hand? Our rescue pack contains an indispensable assortment of specialized equipment for rough-terrain SAR (search and rescue) operations. Don't be caught unprepared!

The rescue pack's contents include 2 100-meter CF ropes; a toolkit; a trauma pack I; two doses of artificial blood; a collapsible, nonpowered stretcher; two insulating blankets; a light exothermal torch (equal in power to the cutting torch described in the *ALTERNITY Player's Handbook*); a self-propelled grapnel launcher; twelve pitons; two lightweight pulleys; and a marker beacon. Item 350892790, \$600, 15 kg

TOOLKIT

In today's fast-moving industrial world, the only thing you can count on year-in and year-out is a good set of tools. Our power tools come with a 10-year warranty; everything else has a 20-year warranty! NOTE: Exposure to nonterrestrial environments may void warranty.

BUT IT'S NOT HERE!

In the STAR*DRIVE setting, interstellar merchants and corporations can literally put their hands on anything. If a hero just has to have an item that isn't in the *ALTERNITY Player's Handbook* listing or this book—a tuning fork, a teddy bear, a regulation basketball, whatever—simply assign a price based on the real-world price of the item. If the heroes are currently adventuring in a cosmopolitan area with constant trade to other star systems, it's quite likely that they could find anything they might need, given time. On the other hand, if the heroes are stuck in an isolated backwater, it might take months for a local merchant to order in weird or unusual items. Use your best judgment, and make it up!

The general toolkit consists of a hammer, pliers, an adjustable wrench, vise grips, screwdrivers, a variety of nails, bolts, nuts, and screws, and a power drill with several different heads (rotary saw, sander, etc.). It weighs 10 kg and provides a -1 step bonus to appropriate skill checks.

Specialized toolkits include more expensive tools especially useful in particular fields—voltmeters and insulated tools for electrical work, wrench sets, magnetic clamps, and welding gear for hull work, and so forth. These kits offer no bonus for general repair work, but in the kit's designated field the specialized tools provide a -2 step bonus. Available specialized kits include:

- Electronics kit (computer, communications, and sensors repair).
- Hull kit (spacecraft mechanical systems, and hull integrity repair).
- Armorer's kit (gun and armor repair).
- Engineer's kit (engine, generator, power distribution, and life support repair).
- Mechanic's kit (vehicular engine, frame, and mechanical system repair).

General kit: Item 380288432, \$100, 10 kg

Specialized kit: Item 381200553, \$300, 10 kg

GENERAL INDUSTRIES WALKER

Strength-enhancing exoskeletons make every person in your workforce a veritable titan, capable of handling loads that would crush a nonsuited human. The military's been using powered armor for years; try out the same technology in your workplace!

The Gravity Age walker replaces the bulky and unreliable hydraulics of earlier versions with magnetic pistons and servos, allowing more power with a lighter and more flexible frame. The wearer's effective Strength is increased to 20 for purposes of lifting or grasping objects. The walker's onboard biofeedback sensors are so highly developed that no particular skill is needed to successfully operate the device.

While operating a walker, the person inside gains a 5-point increase to any damage he or she inflicts in hand-to-hand combat, and improves the firepower of unarmed attacks to Good. The other benefits of extreme Strength—movement, resistance modifier, and skill checks—are still based on his or her natural strength. In addition, a walker is treated like powered armor with a +3 step penalty for action checks, Dexterity feat checks, and so forth. A hero with the Armor Operation—*powered armor* skill may reduce this penalty as described in the *ALTERNITY Player's Handbook*.

Finally, the mechanical systems and frame of the walker provide a modest amount of armor: d6-3 (LI), d8-4 (HI), d6-4 (En). The walker's power supply allows 8 hours of heavy work or 16 hours of light work before it's

necessary to recharge the device. Item 320855003, \$3,250, 120 kg, Common

WEIGHT NEUTRALIZER

The longshoreman's best friend! The weight neutralizer gives every man on the job the effective strength of a forklift. Watch your cargo handling fees plummet!

The weight neutralizer is a small gravity inducer that can be attached to an object in order to counter the effects of gravity on it. It's magnetized for easy attachment to metallic crates and containers, but a simple retaining strap is also included. The neutralizer has an endurance of 10,000 kilogram-hours, so an object weighing two metric tons (2,000 kg) could be rendered weightless for 5 hours.

Inertia and momentum are not neutralized by this device. A massive object hovering in mid-air can be pushed around slowly by a man on foot, but it could still crush someone or something before it came to a full stop, and a car that crashed into a neutralized boulder would still sustain normal collision damage. Item 360299802, \$300, 4 kg, Common

MISCELLANEOUS GEAR

The Rignunmor Star Consortium Merchant Exchange is proud to offer products from over 85,000 different manufacturers. Anything you can think of, we can sell. We've included only a tiny percentage of our goods in this brief excerpt from our Miscellaneous Goods catalog disk.

AUTOKEY

Forget your key card? The autokey can crack any security system. Set it over the recognition panel and let the autokey do your lockpicking for you!

The autokey is a device about 12 cm × 8 cm × 1 cm. It has two modes of operation: magnetic code and bioelectric signatures. When placed over a biolock or card-recognition lock and activated, the autokey emulates an approved passcode through trial and error. Using an autokey adds a -2 step bonus to a character's

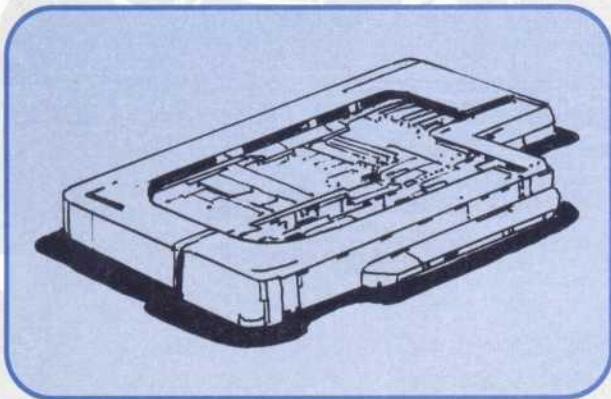

Autokey

Manipulation or Security skill checks to break a biolock, or a -4 step bonus for simpler key-card locks.

Many lock panels are keyed to sound an alarm when a certain number of invalid signatures are attempted, so using an autokey is not without risk. It's a good idea to disable any security alarms before using the autokey to break the lock's passcode. Item 495200366, \$1,500, 1 kg, Controlled

BINDERS

Need to handcuff someone in a hurry? Our personal restraints are easy to apply, impossible to escape, and certified not to cause collateral injury while worn.

Made from virtually indestructible carbonate fiber strands, binders are easier to use than earlier handcuffs and offer greater flexibility. With a length variable from 2 to 60 cm, they can be used in a variety of holds. While bound, the subject's Strength and Dexterity-based resistance modifiers are reduced by 1 step, and he may not make unarmed attacks. Binders also include a stun circuit triggered by a command baton (range 100 meters); the pulse inflicts 2d6s to a difficult prisoner, but the binders only have enough energy for three charges before they're exhausted.

Binders don't have any lock to pick—they're keyed by microcircuitry. The command baton is the only device that can open the binders, although most law enforcement agencies mandate that desk sergeants and shift commanders carry "master" batons, capable of stunning or opening any set of binders in the facility.

Binders can be cut or severed with the right tools. Carbonate shears or a laser torch would work, as well as any low-impact or energy weapon that inflicts damage of at least Good firepower. An unwilling target must first be overpowered before binders can be applied. Item 460788232, \$175, 0.5 kg, Common

BLASTPROOF™ BIOLOCK

The finest personal security money can buy! Once keyed to your signature, the biolock cannot be opened by any other means. No combinations to forget, no keys to lose!

Bilocks come in padlock, vehicular, and deadbolt designs. Up to ten different people can be scanned into the recognition plate as authorized users. Bilocks are completely resistant to lockpicking attempts, and are considered to be devices of Amazing complexity and difficulty (minimum 6 successes at a +3 step penalty) for attempts to break them with the Security-security devices skill. Bilocks can be physically destroyed, of course, but have Good toughness, 8/8/4 durability, and armor that stops d6+1 (LI), d6+3 (HI), d6+1 (En) points of damage. Item 490233500, \$100, 1 kg

BERTEK CIRCUIT FINDER

Why waste time tracing out wiring diagrams? The circuit finder lets you get right to the place where you want to work.

The circuit finder is a sensitive but short-ranged EM detector that can detect electrical current in lines or conduits hidden by walls. It's very useful for finding shorts, alarm circuits, and faulty switches, as well as determining if a spot is safe to cut through. The device is about 8 cm × 3 cm × 1 cm and can detect and localize current within 2 meters. Item 440677089, \$100, 1 kg

MR. FOAMY™ FIRE EXTINGUISHER

Safety first! Our high-tech, nontoxic, firefighting concentrate smothers Class A, B, and C conflagrations in no time at all, and better yet, causes no collateral damage to delicate wiring or electronics!

The modern fire extinguisher projects a spray of chemical powder that inhibits combustion, covering an area of up to 30 square meters. This is enough to extinguish a roaring fire in a vehicle, a medium-sized shipboard compartment, or a small house or shop. Hypothermic reactions in the spray also cool the affected area, eliminating the chance of reflash. Item 440299731, \$25, 5 kg

RONYO HOLOVIEWER

Your key to the entertainment emporium of the 26th century, the holoviewer's cable feed and programmable channel selector let you choose from up to 5,400 broadcasting stations . . . or just play a 3D crystal if you can't find anything to watch!

The holoviewer has three modes of operation: 3D player, broadcast reception, or cable feed. The holographic images produced by this device are astonishingly lifelike, and many people personalize their homes with statues or scenes of living light.

The newest craze is interactive holoprogramming; with the right entertainment software and a slaved holorecorder, a computer can use a holoviewer to present games or stories in which the audience actually plays a part. Wealthy eccentrics have been known to fill their homes with holographic tableaux of a exotic, erotic, humorous, or shocking nature.

The holoviewer itself is a disk about 0.5 meter in diameter and 5 cm thick. The most common models have a 3-meter projection radius, but larger holoviewers are available at higher prices. Item 420459662, \$500, 3 kg

TYKO MINIWINCH

Some jobs demand heavy lift capacity in a small space. If you're facing one of those jobs, the TyCo miniwinch is the tool for you!

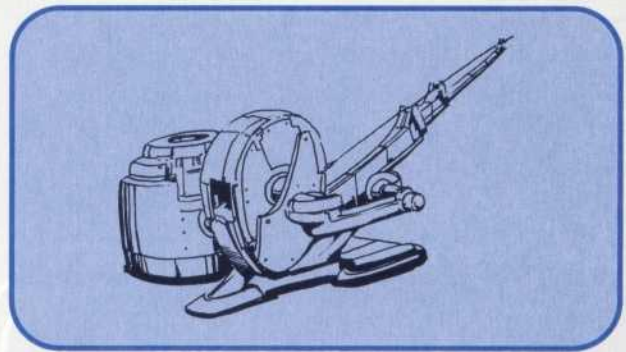

TyKo Miniwinch

The miniwinch consists of a powerful electric motor, a drum with 100 meters of high-test wire, a telescoping arm and pulley, and a baseplate that can be bolted or magnetized to almost any surface. When stowed, the whole device can be carried inside a backpack. The miniwinch can handle loads of up to 220 kg, which means that two large men can be hauled up a 100-meter cliff by this device. The telescoping arm gives the winch a "reach" of 1.5 meters, and it can reel in or spool out 10 meters of wire per phase. The miniwinch's lanthanide cells provide enough power for 1 hour of operation at maximum capacity, or 4 hours with loads of 110 kg or less. Item 440190675, \$200, 7 kg

BOND-O-MATIC™ MOLECULE WELD

"Glue. Strong stuff."

Molecule weld is a clear, goeey material that can join any two solid materials together. It's completely inert until a small electrical shock is applied—and then it instantly sets, forming molecular bonds with any material to which it's applied. (A tube of molecule weld is sold with a small battery-powered "sparker" for this purpose.) Anything short of neutronite plate is stronger at the molecule weld than it was before! Molecule weld just doesn't break—if two objects joined by weld are wrenched apart, one or the other of them will snap, shatter, or lose a divot around the spot of the weld.

If a character is glued to something with molecule weld, he can be cut free with any sharp instrument or pull himself free by making a Strength feat check (+1 step penalty for each square centimeter of adhesive). However, success inflicts d4-2w for each square centimeter of weld with which the character was held. A tube of molecule weld contains enough material to cover 20 square centimeters. Item 460788427, \$30, 0.2 kg

AEROCASTER™ MUSIC GAUNTLET

Whether you're a professional musician or play for just for your own enjoyment, you'll love the sound of our new Aerocaster music gauntlet. Long recognized as the bench-

mark of quality in musical synthesizers, Aerocaster gauntlets are completely programmable and customizable to your style of play.

The music gauntlet is the air-guitar player's dream. The gauntlet's sensors read the wearer's hand motions and interpret them as if the user were actually playing the instrument in question. While the musician might seem to be drumming on air or playing the electric piano across a tabletop, the gauntlet creates a perfect representation of the instrument it's set to recreate. A music gauntlet includes three remotes—an off-hand glove to record the motions of the wearer's secondary hand, a foot pedal that can be used as a whammy bar, bass drum, or other foot-operated devices, and a mouthpiece for duplicating wind instruments.

In terms of sound quality, affordability, and portability, the music gauntlet is the way to go. On the other hand, most serious musicians find that the gauntlet's too good—it lacks the soul and style of an authentic instrument. Real instruments cost anywhere from \$500 to \$5,000, and antique pieces may cost as much as \$100,000; there just aren't that many Fender StratoCasters around anymore. Item 430597808, \$250, 1 kg

PSI-RESTRAINTS

Let's face it. . . handling psi-capable prisoners is every security officer's worst nightmare. Even wary professionals can be killed, disabled, or subverted by a supposedly "unarmed" mindwalker. Here's a way for you to level the playing field.

All psi-restraints are "locked" by electronic keys or codes. Removing a psi-restraint without the key requires a security devices skill check at a +2 step penalty. For an extra \$1,000 beyond the normal price, a psi-restraint can be installed with a bomb circuit; this detonates by remote command, or whenever someone critically fails or strikes out in an attempt to tamper with the restraints. A bomb circuit inflicts d4+4m (armor does not reduce this damage) to the wearer of the restraint, and d6-1w of En/O damage to anyone within 2 meters.

A. Psi-restraint helm. When activated, the helmet's neural interference circuitry adds a +4 step penalty to the wearer's attempts to use psionic skills, and a +1 step penalty to any Intelligence-based skills. Its visor also blinds the wearer. Item 480209766a, \$1,200, 2 kg, Restricted

B. Psi-restraint collar. The collar has the same effects as the helmet, but the wearer's vision is not impaired in any way. The collar is light enough to be worn under normal clothing, allowing a restrained character to move about and interact normally. Item 480230084b, \$1,700, 1 kg, Restricted

C. Psi-restraint implant. Attached at the base of the mindwalker's skull, the implant can be adjusted directly

through a tiny control panel hidden beneath the wearer's hair, or remotely through a handheld transmitter with a range of 200 meters. The amount of interference can be set anywhere from none to +5. Removing an implant requires a Medical Science—*surgery* skill check. Item 480995211c, \$3,500, Restricted

SEKURETEK POWER RESTRAINTS

Everyone knows how to handle mindwalkers with psi-restraints, but what about mutants or cyber-wired criminals? They're dangerous, too! Our new power restraints can handle anything you can throw at them!

Power restraints bear a strong resemblance to psi-restraints and come in similar designs. In addition, a gauntlet model that shackles the wearer's hands while neutralizing his special powers is also available for \$2,200. Two basic types of power restraints are available:

Biodampers control energy surges in the wearer's bio-electric field, making it difficult to use consciously activated mutant powers or superpower FX. The biodampers provide a +3 step penalty to the use of these abilities. Item 480100332, \$1,000, 1 kg, Restricted

Cyberdampers scramble the cytronic circuitry necessary for controlling cybernetic implants, rendering them useless; any benefits or capabilities provided by the implants are lost while the cyberdampers are worn. Item 480100436, \$1,200, 1 kg, Restricted

ROPE

Whether you're a weekend climber or a professional rescue worker, a little rope's a good thing to have. Our newest carbonate fiber lines are the lightest and strongest ropes commercially available!

A. 2mm CF Line. Used in miniwinches and ultralight-weight applications, 2mm line can support up to 150 kg of mass. Item 410100002, \$10 and 0.1 kg per 10 meters

B. 5mm CF Line. All-purpose line for climbing or rescue work, 5mm line can support a hefty 500 kg. Item 410100005, \$3 and 0.2 kg per 10 meters

C. 10mm CF Line. Medium-weight line for hauling or lifts, 10mm line supports up to 1,500 kg. Item 410100010, \$5 and 0.4 kg per 10 meters

D. 15mm CF line. Heavy-duty line for serious heavy work, 15mm line is rated for 3,000 kg. Item 410100015, \$7 and 1 kg per 10 meters

E. 10mm wire rope. Consisting of a tough tungsten-aluminum wire in a sheath of carbonate fiber, wire rope is heavy but incredibly strong; the 10mm rope can withstand up to 10,000 kg. Item 410200010, \$15 and 3 kg per 10 meters

Like a gigantic spider, VoidCorp sits at the center of a titanic web of interstellar commerce. In the course of its three-hundred-year history, the megacorp has absorbed thousands of lesser firms, embracing every field of manufacture or mode of commerce known to man. There's nothing that VoidCorp doesn't build, buy, or sell somewhere. But beneath the endless layers of ownership and corporate holding companies, the business in which VoidCorp made its first trillion dollars was computer hardware and software architecture. These initial successes provided the fuel for three centuries of predatory expansion.

To this day, VoidCorp's computer division is a steady source of income for the company. While millions of consumers find the corporate drive for technological hegemony over the galaxy distasteful, one fact disarms a seething sea of ill will: VoidCorp manufactures top-notch computer equipment and sells it at competitive prices. In fact, VoidCorp Division One represents one of the most ethical and responsible branches of the company. Its job is simply to sell its product by delivering high quality at a reasonable cost.

Division One sells computers and other technical gear to all kinds of buyers—mass orders for governments and megacorps, customized orders for industrial facilities, even mass-produced brand names for sale through other

retail outlets such as the Rigunmor Star Consortium Merchant Exchange—but heroes are most likely to encounter Division One wares in the format of VoidCorp's *CompuCatalog One*. This is the primary direct-sale tool of the company, a mail-order service that caters to small companies and professionals who know what they want.

CompuCatalog One (widely known as *CC1*) isn't published—it's available online in the Division One headquarters at Catalog, the VoidCorp capital. The Catalog site is continuously updated and offers the most current array of goods and services. Division One maintains local *CompuCatalog* access sites in most major star systems. These access sites are updated from the Catalog site once per month via drivesat data relay, ensuring that they're never too out of date.

IN THE VERGE

CompuCatalog One local access sites have been established on Alaundril in the Tendril system, at Bluefall in the Aegis system, and in the Corrivale system. This last site is part of VoidCorp's strategy for returning to Grith. Division One is currently negotiating with an Alitaran computer company to get a site up and running in the Algemron system, too.

ORDERING INFORMATION

Consumers have three choices for ordering from *CompuCatalog One*—they can send shadows via interstellar drivesat relays to deal with the Catalog site, they can choose to access a local *CC1* site in real time, or they can send a shadow to a local site. Outsystem orders are subject to a flat \$110 delivery and insurance charge, and require d4 weeks to fill. Insystem orders add only \$29 for shipping, and can usually be delivered within a matter of days.

COMMUNICATIONS GEAR

BEACON CMB577865

Class: Communications

Availability: Any

Cost: \$400 (A), \$450 (B), \$150 (C)

Mass: 20 kg (A); 15 kg (B); 2 kg (C)

Dim: (A, B) 20 cm × 20 cm × 30 cm;

1 m × 1 m × 2 m deployed.

(C) 10 cm × 10 cm × 6 cm

A. Automated Beacon. The automated beacon is a long-endurance radio navigation aid. Its signal can be set

OPPORTUNITY KNOCKS?

Every item in *CompuCatalog One* is manufactured by VoidCorp-controlled companies and subsidiaries. When the company encounters a potential source of competition in a local manufacturer, VoidCorp typically initiates an acquisition. In many parts of space, anti-monopoly legislation is weak or unenforceable, and, given the chance, VoidCorp seeks to corner any market it becomes involved in. Many of the noncomputer systems or gadgets in this catalog fell into VoidCorp's hands in this fashion. Plotting the defense of a small company from a hostile takeover, or keeping VoidCorp "acquisition specialists" (i.e., spies and saboteurs) at arm's length, might make for an interesting adventure. Some other uses for *CompuCatalog One* in a campaign:

- It's rumored that the Insight Division has subverted part of the *CompuCatalog* and is using VoidCorp's own order system to pass information and propaganda against the megacorp.
- VoidCorp doesn't care what people do with its computers—an entrepreneur might order a number of desktops with the idea of retailing them in remote systems where the demand is high.

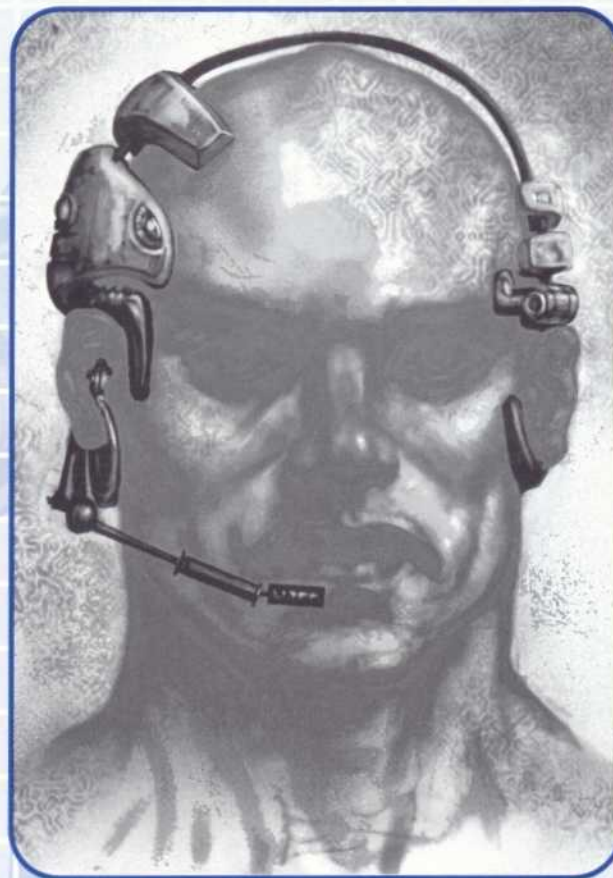

Communications Gear (handheld, headset)

for constant or intermittent emission, or the beacon can be set to transponder mode, only pinging in response to a preselected interrogatory signal. Automated beacons are useful for Navigation or Vehicle Operation skill checks in difficult conditions—an active beacon reduces any penalties for poor conditions by 2 steps. The range of an automated beacon is 500 km in a planetary environment, or 50,000 km in space. Its power cells allow 1 year of normal operation.

B. Emergency Beacon. The spacefarer's SOS signal, an emergency beacon is standard equipment on most spacecraft and life pods. When set up and activated, the beacon periodically emits powerful radio signals to mark the user's location for any passing vehicles. The beacon's signal can be detected from 5,000 km away on a planetary surface, or from as far as 5 AU (750 million km) in open space. The emergency beacon lasts for 5 years before its cells run out of power.

C. Marker Beacon. A much smaller beacon used to mark very specific locations, the marker is usually used for precise surveys or locations—archeological sites, camps or caches, and so forth. Bantam rockets and heavier ordnance can be set to guide on the marker's signal, providing a -3 step bonus to the attacker's skill check when he fires at the beacon. Marker beacons have magnetic clamps for easy attachment to a variety of surfaces. The beacon has a range of 250 km and a duration of 1 month.

COMMUNICATOR CMC290371

Class: Communications

Availability: Any

Cost: \$100 (A), \$175 (B), \$300 (C)

Mass: 100 g (A), 100 g (B), 5 g (C)

Dim: Handset: 15 cm × 6 cm × 1 cm;

Card: 8 cm × 5 cm × 3 mm

A. Cellular Communicator. Basically a handheld radio that directs its transmissions to the nearest convenient relay, the cellcomm is popular on developed planets with global relay coverage. It can reach relay towers up to 1,000 km distant; once the communicator's got a relay, the user can reach any point on a planet or in a system through commercial comm circuits. The unit is available in card or handset models. Its batteries must be recharged once a week.

B. Multiband Comm Gear. This is a frequency-agile handheld radio available as a card, handset, or headset. Unlike the cellcomm, comm gear doesn't patch into a local circuit—it's an independent communication system. Since it can transmit and receive on a variety of frequencies, comm gear is more versatile and resistant to interference or jamming than a cellcomm. The transmitter has a surface range of 1,000 km, or a line-of-sight range of 10,000 km.

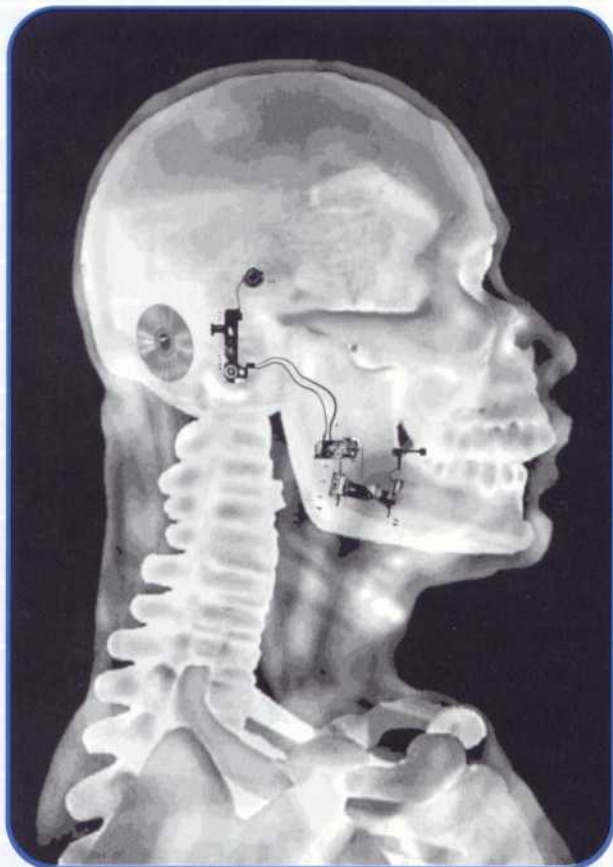

Communication Gear (subdermal)

C. Subdermal Communicator. Consisting of miniaturized comm gear implanted near the user's jawbone, the subdermal communicator is made for stealthy or subtle communication jobs. The wearer can toggle a hidden microswitch to transmit simply by speaking aloud; he can receive transmissions without a sound. The device has a range of 10 km, and breaks down into easily absorbed components after one month. Installing or removing a subdermal communicator requires a Medical Science—*surgery* skill check.

MASS TRANSCIVER CMT844002

Class: Communications

Availability: Common

Cost: \$4,000

Mass: 50 kg

Dim: 80 cm × 50 cm × 50 cm

The central feature of the mass transceiver is a gravity induction device that generates gravitational waves by varying the mass of the main signal guide. Gravitational waves appear to propagate faster than light, allowing true instantaneous communication with no time lag for distance between transmitter and receiver. Although no one has managed to build a mass transceiver powerful enough to bridge the gap between the stars, mass trans-

ceivers are useful for passing information within a stellar system.

The semiportable mass transceiver described here requires a separate source of power—a portable fusion generator or vehicular power plant is typical. Mass transceivers can only talk to other mass transceivers—a hero can't pick up a mass signal on his personal radio. The transceiver described here has an effective range of 10 AU, or about 1.5 billion km. Larger transceivers, such as those found on starships or in major installations, have ranges of 40 to 100 AU. Beyond this distance, the background gravitational signatures of a star system mask the transceiver's oscillations.

Smaller mass transceivers are available, but the technology is new and the devices tend to be very expensive—see the next entry.

PACK, COMMUNICATIONS CMP199802

Class: Communications

Availability: Common

Cost: (A) \$1,500; (B) \$15,000

Mass: (a) 20 kg; (B) 100 kg

Dim: (A) 35 cm × 20 cm × 75 cm;

(B) 1.5 m × 2 m × 1 m

A. Laser Comm Pack. Lasers are an excellent medium for communication. They're perfectly directional and offer no possibility of hostile intercept, they have a high baud rate for the transfer of information, and in the right medium a laser can carry a signal for millions of kilometers. The laser comm pack is built around a powerful signal laser and sighting mechanism, with a general conversion jack for vocal, video, or datastream transmission and reception.

The laser's planetary range is line of sight, but in open space it can reach up to 5 AU easily. However, it's impossible to hit a target as small as a ship from this distance without some kind of aiming point—for instance, a point in a certain constellation, or a terrain feature on a moon. (A System Operation—*communications* skill check is appropriate for checking a laser's aim.) The pack's lant cells allow up to 10 hours of continuous communication before they must be recharged.

B. Mass Comm Pack. This is a miniature mass transceiver, powered by its own lant cells. It has only a fraction of the range of a transceiver unit (1 AU at best), but can be transported from place to place if it is loaded onto a cart or some other vehicle. The pack's batteries can power 1 hour of continuous communication before they must be recharged. Like the transceiver, the mass comm pack can only send signals to another mass communication device.

MODULE, COMMUNICATIONS CMM663817

Class: Communications

Availability: (A) Common; (B) Military; (C) Controlled; (D) Controlled

Cost: (A) \$50; (B) \$500; (C) \$200; (D) \$100

Mass: 70 g

Dim: 8 cm × 5 cm × 2 cm

A. Datastream Module. About the size and shape of a plastic key card, this module is designed to cradle or connect to a cellcomm, comm gear, vidphone, or other communication device. A 2-meter microwire lead ends in a jack suitable for a computer's comm port or a cybernetic character's NIJack. The datastream module simply allows a computer to transmit and receive information over any kind of communications gear.

B. Encryption Module. Resembling the datastream module in size and use, encryption modules are sold in pairs. Attached to a normal communicator, the encryption device automatically scrambles the signal so that anyone listening in can't understand a thing. Only the matching encryption module can decipher the transmission.

C. Voice Modulation Module. Like the other modules, a voice modulator is simply fitted to another communications device. When activated, it allows the speaker to alter his voice patterns to just about anything imaginable, although it doesn't give him the ability to speak in another language. The modulator is perfectly capable of mimicking a specific person, if the character can obtain a recording of that person's speech patterns.

D. Uplink Module. Most Gravity Age communications devices have sufficient power to reach orbital satellites or ships, but finding the right part of the sky to point at is another matter. The uplink module zeroes in on a "marker" signal from the target satellite or ship, allowing the user to select orbital targets simply by dialing a selector on the module. On highly developed worlds, the user might have dozens or hundreds of orbital stations to choose from.

TRANSLATOR CMT909163

Class: Communications

Availability: Common

Cost: (A) \$1,500; (B) \$2,250

Mass: (A) 500 g; (B) 600 g

Dim: 15 cm × 10 cm × 5 cm

A. Translate. While no universal translator exists in the Gravity Age, fairly good facsimiles for known languages exist. The translation slate—translate, for short—is a device similar in size and shape to a standard data slate, with the addition of a built-in microphone and speaker unit. With

a standard language 3D in place, the translate converts a foreign phrase or sentence into an equivalent phrase in the second language, and plays it through the speaker. Using a translate is a little awkward, since the speaker must press a start button, speak clearly and plainly, then press a stop button to trigger the translation. Complicated concepts, exact emotional inflection, and other such nuances may be hard to get across. Translate language 3Ds are available for every known human tongue and all major alien languages, costing \$100 each.

B. Active Interpreter. This device is a translate with a wire lead to an earpiece and a second lead to an amulet-like throat speaker. The throat piece generates a perfect interference with the wearer's natural voice, silencing his speech in his native language while enunciating the translated words. The active interpreter continuously translates for the wearer without the stop-and-go exchange of a normal translate. Favored for diplomatic functions, the device can easily be worn under any clothing.

VIDPHONE CMV564861

Class: Communications

Availability: Any

Cost: (A) \$400; (B) \$750; (C) \$1,850

Mass: (A, B) 1 kg; (C) 2 kg

Dim: (A, B) 20 cm × 12 cm × 6 cm

(C) 25 cm × 20 cm × 15 cm

A. Vidphone. Many people prefer face-to-face communications. Portable video phones are every bit as popular as cellular phones in earlier years. The vidphone's optic pickup is a small video camera. A character on the go can hold the vidphone about half a meter in front of her face and look into it as she talks, but most folks prefer to set the vidphone on a desk or dashboard to use it.

The vidphone can be set for send only, receive only, audio mode, or full two-way video. Its camera, while small, is a normal video camera and can be used to "record" images or scenes simply by calling up someone who has a video recorder attached to his or her vidphone.

B. Heads-up Vidgear. Resembling comm gear, the heads-up version of the vidphone includes a transparent eyescreen that the wearer can flip down over his face to receive video over his communication circuit. His own transmission camera is worn as part of his headpiece and shows what he's looking at, not his own face (although it's easy enough to detach the camera feed and look into it). Heads-up vidgear is available in cellular or independent models.

C. Holophone. The holophone is a small console with two separate camera pickups in order to catch the speaker's face in three dimensions. Its base is a small holoprojector, allowing the user to converse with a holographic image of the other party. Usually, holophones are set to

portrait mode, simply showing the head and shoulders of each party, but the speakers can select full-image transmission and reception. In this mode, the holophone projects a 20-cm tall miniature image of the other party. Holophones aren't available in heads-up models.

SENSORS

DETECTOR SDD209807

Class: Sensors

Availability: Any

Cost: (A) #250; (B) #250; (C) #125; (D) #125

Mass: 2 kg

Dim: 25 cm × 12 cm × 4 cm

A. Biodetector. The biodetector is a handheld unit about 15 cm × 10 cm × 3 cm. It's a specialized biochemical sniffer that detects traces of key organic compounds in an area. While the biodetector can't detect specific lifeforms or track their movements, it can determine if life exists, what its basic chemistry or series is, and what type of creatures (small plants, large carnivores, microbes only, etc.) inhabit the area. The detector provides a -2 step bonus to Life Science-*biology* or System Operation-*sensors* skill checks to search for or classify life signs. It can sniff an area roughly 50 meters in diameter with 12 seconds (1 round) of readings.

B. Chem Detector. Resembling the biodetector in form, the chem detector is a general-purpose sniffer and taster device that can analyze atmospheric composition or specific substances it is brought into contact with. It provides a -1 step bonus to the user's Physical Science-*chemistry* or System Operation-*sensors* skill checks to detect or classify chemical compounds in the vicinity.



Biodetector

C. EM Detector. This device detects electromagnetic energy and transmissions. It's useful for detecting radio or radar emissions, measuring an object's radiant heat, and measuring magnetic fields. Note that x-ray, gamma, and cosmic radiation are part of the EM spectrum, so the detector can also spot dangerous radiation levels. The detector provides a -1 step bonus to the user's Physical Science-*physics* or System Operation-*sensors* skill checks in these areas.

D. Rad Detector. The radiation detector combines a high-band EM detector with a series of plates designed to measure particulate (alpha, beta, or neutron) radiation levels. The detector provides a -2 step bonus to Physical Science-*physics*, System Operation-*sensors*, or Awareness-*perception* skill checks to spot danger or localize specific sources of radiation.

GAUNTLET SDG297003

Class: Sensors

Availability: Common

Cost: (A) #550; (B) #725; (C) #350

Mass: 2 kg

Dim: 40 cm × 12 cm × 10 cm (approx.)

A. Diver Gauntlet. The gauntlet is an easy-to-use frame for many kinds of sensors and hardware. Fitting over the forearm and hand, it's light, durable, and convenient. The diver gauntlet is completely waterproof; it has a small sonar transducer and display, an inertial mapping system to help the diver keep track of his location, and a blood chemistry sampler that continuously monitors for dangerous conditions (narcosis, the bends, etc.) and warns the diver when he must return to the surface. The gauntlet reduces penalties for visibility or disorientation by 2 steps and provides a -1 step bonus to any Daredevil-*diving* or Movement-*swim* skill checks.

B. Sensor Gauntlet. This useful device miniaturizes the EM and chemical detectors described in the previous entry and combines them in one convenient platform. Optionally, sensor gauntlets may be specialized to include any two of the four detector devices described above, so it's possible to buy a biochem sensor gauntlet, a chemrad sensor gauntlet, and so forth. The gauntlet provides a -1 step bonus to the user's Life Science, Physical Science, Awareness, and Investigate skill checks.

C. Radar Gauntlet. The radar gauntlet features a small phased-array radar system that gives the user the ability to detect vehicles or objects far beyond his

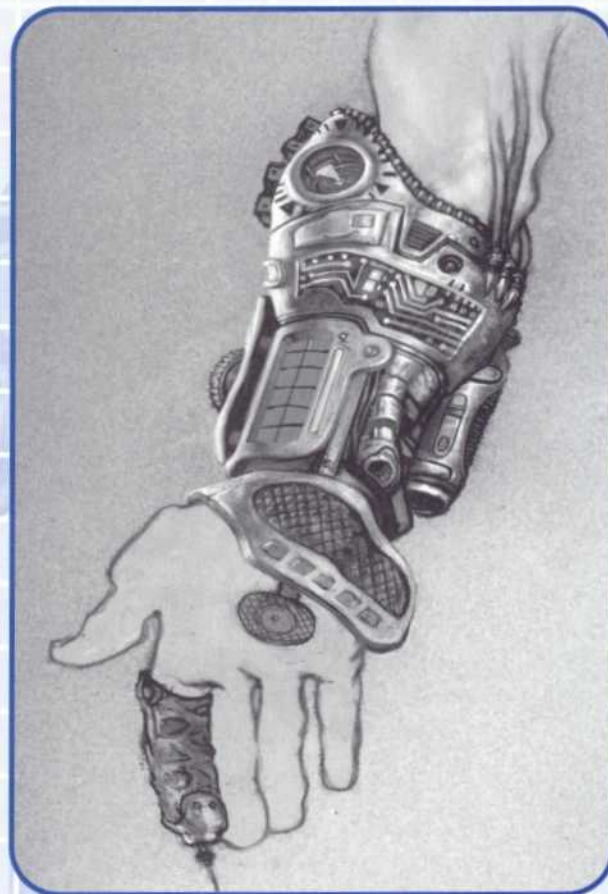

Diver Gauntlet, Sensor Gauntlet

or her range of vision. The gauntlet can detect vehicles or characters in powered armor at a range of 5 km, airborne vehicles at a range of 100 km, and ships in open space at a range of 2,000 km. It is an active sensor whose emissions can be detected by any EM detector at twice its own detection range. Naturally, hills, mountains, or buildings may shorten the gauntlet's range. The device is operated by means of the System Operation—*sensors* skill.

GOGGLES SDVI99840

Class: Sensors

Availability: Common

Cost: (A) \$300; (B) \$425; (C) \$350; (D) \$250

Mass: 175 g

Dim: 15 cm × 5 cm × 1 cm (approx.)

A. Imaging. Also known as light-intensifying goggles, imaging goggles boost ambient light reaching the user's eyes to provide effective night vision. The goggles reduce darkness-based penalties by 2 steps, but they need some light to work—total darkness blinds the wearer. Unlike the imaging goggles of earlier Progress Levels, these are relatively light and easy to wear, and do not obstruct the wearer's peripheral vision.

B. Magnifying. The binoculars of the Gravity Age,

magnifying goggles sense the muscular motions of the wearer's eyes and dilate to magnify and focus on the object examined. The goggles provide 10× magnification, so an object 200 meters distant appears to be only 20 meters away. In addition, magnifying goggles negate 1 step of range-based penalties for firing weapons at targets more than 100 meters distant (provided the weapon does not already have a scope of some kind). Constant use of magnifying goggles causes some eyestrain after an hour or two.

C. Thermal. Another night-vision device, thermal goggles convert infrared light to visible light, allowing the user to see in the infrared (or heat) spectrum. Thermal goggles completely negate darkness-based penalties, as long as there are opponents or targets that stand out from the background temperature of the surroundings. Thermal goggles also provide a -1 step bonus to Investigate skill checks to detect new tracks or recently handled objects. Gravity Age thermal goggles have damper systems to negate the blinding effect of sudden heat blooms.

D. Sonic. Two forms of sonic goggles exist. The first converts sound echoes into visible light, allowing the user to see by echolocation. This negates darkness- or water-based penalties. The second version costs \$2,500 and requires a cybertech implant in the wearer's visual cor-

tex. It allows the wearer to literally see sound, providing 360-degree vision and negating any penalties for blindness.

NAV GEAR SGN097862

Class: Sensors

Availability: Common

Cost: (A) *750; (B) *125; (C) *900; (D) *100

Mass: (A) 500 g; (B) 200 g; (C) 500 g; (D) 200 g

Dim: (A, C) 15 cm × 10 cm × 3 cm;

(B, D) 7 cm diameter, 2 cm thick

A. Celestial Navkit. This kit is a modified data slate built around a head-down starfinder and holosextant. The navkit's internal sensors compute horizon location in any terrain, and its repeater display lets the navigator shoot his bearings without the tedious and painstaking process of swinging a sextant. Three identifiable stars allow the user to compute his exact location on a planet's surface in about a minute. Celestial navigation doesn't rely on a vulnerable satellite network, but a heavy overcast prevents the user from shooting stars. The celestial navkit requires a planetary database for each world it's going to be used on; a world-disk costs *50. The celestial navkit provides a -2 step bonus to Navigation-*system astrogation* skill checks.

B. Gyrocompass. The gyrocompass, or inertial compass, uses a battery-powered gyroscope to indicate true north. Its lanth cell lasts for 60 days of continual operation. The gyrocompass provides a -1 step bonus to Navigation-*surface navigation* skill checks.

C. Inertial Navkit. This device uses extremely sensitive accelerometers to record exactly how far it moves in every direction, creating a flawless track of the user's motion across, over, or under the surface of a planet. Like the celestial navkit, the inertial kit requires a planetary database of detailed topographical information in order to be useful. The inertial navkit provides a -2 step bonus to the user's Navigation-*surface navigation* skill checks, and its lanthanide cells provide up to six months of operation.

D. Satellite Receiver. Using navigational signals from a constellation of special satellites, the sat receiver (also known as a GPS system) simply provides the user's exact coordinates on demand. It provides a -2 step bonus to the user's Navigation-*surface navigation* skill checks, but only if there is a satellite navigation system in place—without the satellites, the receiver is useless.

SCANNER SSD004598

Class: Sensors

Availability: Common

Cost: (A) *375; (B) *125

Mass: 1 kg

Dim: 18 cm × 9 cm × 6 cm

A. Imaging Scanner. Using advanced magnetic resonance technology, the imaging scanner provides an inside look at anything it's touched to. Its field of view is 8 centimeters wide, and the focus depth can be adjusted from 1 centimeter to 3 meters by a simple dial. It's useful for locating alarm circuits and analyzing locks, scanning packages or crates to examine their contents without opening them, or determining the extent of a wounded comrade's injuries. In general, the imaging scanner pro-



Imaging Scanner

vides a -1 step bonus to Demolitions-*disarm*, Technical Science-*repair*, Security-*security devices*, and Manipulation-*lockpick* skill checks.

Some security systems or bomb fuses are set to react to the magnetic field of an imaging scanner; heroes should not assume that it's always safe to use this device.

B. Weapon Detector. This device is a simple imaging scanner designed to provide a wide-field scan for dense objects. Coupled with the scanner is a chemical sniffer sensitized for conventional and plasma explosives. The weapon detector can't provide the thorough examination of an imaging scanner, but it's much faster and adds the capability of sniffing out explosives. System Operation-*sensors* and Investigate-*search* are the skills associated with the weapon detector; the device provides a -2 step bonus to either in detecting metallic or hard plastic weapons.

Weapon detectors and imaging scanners can be defeated by antiscan weave.

SURVEILLANCE GEAR SEC990765

Class: Sensors

Availability: Military

Cost: (A, D, E, F) \$250; (B, C) \$600

Mass: (A, E, F) 20 g; (B, D) 100 g; (C) 500 g

Dim: (A, E, F) 5 mm × 5 mm × 2 mm

(B, D) 5 cm × 3 cm × 2 cm

A. Bug. This is a tiny, easily concealed audio pickup. Bugs must be attached to either transmitters or recorders in order to convey the information they receive. Typically, the bug is directly connected to a transmitter, or feeds to a hidden recorder by means of a wire lead. Bugs can pick up normal conversation at a range of 20 meters in rooms with typical background noise.

B. Microcam. This unit is a tiny vidcam that can capture both audio and visual feed. Like the bug, the microcam must feed to either a transmitter or a recorder in order for its information to be recovered. Microcams can also film through tiny fiber-optic tubes dozens of meters long, allowing the user to reduce the camera's "footprint" in the surveillance area to the end of a wire.

C. Laser Microphone. This mike measures the microscopic displacement of a window pane caused by conversation in the room beyond, picking up anything spoken inside. The laser mike has a range of 250 meters, and can even record conversation across an intervening stretch of vacuum.

D. Recorder. This tiny device records the feed of a bug or a microcam onto a miniature 3D crystal for later recovery and play. Since recorders don't actively transmit, they're less likely to be found in antibus sweeps, but the user has to figure out a means to get to the information.

E. Transmitter. The other option for a bug or a microcam is to simply relay its findings by low-powered radio transmissions on a continual basis. The transmitter is easier to use, but security devices are more likely to pick up its signals than a recorder's operation. The transmitter has an effective range of 200 meters.

F. Trace. The tracer device is a tiny radio transmitter that emits a homing signal. Concealed on a vehicle, in luggage, or even on a target's clothes, it can be detected by a signal tracker (see the next item) at ranges of up to 30 km. Traces can be set to begin transmitting immediately, after a certain time delay, or when a specific interrogatory signal is received.

TRACKER STR344070

Class: Sensors

Availability: Controlled

Cost: (A) \$250; (B) \$325

Mass: 700 g

Dim: 18 cm × 6 cm × 4 cm

A. Signal Tracker. A trace is useless without a specialized signal tracker to home in on its transmission. The tracker is a sensitive radio receiver with two separate antenna elements; by comparing the signal between the two receptors, it can determine the direction and approximate strength of the selected signal. The signal tracker provides a -3 step bonus to the user's Investigate-track skill checks to follow an active trace, or (optionally) allows the user to track with his System Operation-sensors skill at a -1 step bonus. The signal tracker can also be coupled to an EM detector to determine the precise origin of an unknown signal.

B. Sonic Tracker. The scout's best friend, the sonic tracker detects motion in the immediate vicinity by measuring subtle variations in air pressure. The tracker negates any Awareness check penalties caused by poor visibility, dense ground cover, or cluttered terrain, making it more difficult to surprise the user. In addition, in open terrain, the tracker provides a -2 step bonus to the user's Awareness checks. It is more effective against large, fast-moving targets than small or stationary ones; apply a -1 step bonus to the user's skill checks for large or fast creatures, and a +1 step penalty for small or slow ones.

VIDCAM SRD100661

Class: Sensors

Availability: Common

Cost: (A) \$1,650; (B) \$800; (C) \$350

Mass: (A) 1 kg; (B) 200 g; (C) 1 kg

Dim: (A, C) 25 cm × 6 cm × 4 cm

(B) 12 cm × 4 cm × 3 cm

A. Dual Holocam. One of the initial stumbling blocks in public acceptance of holophotography was the requirement for two separate holorecorders to capture a single scene. The dual holocam changes that. This recorder features a light, boom-mounted repeater lens that, at maximum extension, sits 1.7 meters from the camera proper. One camera operator working with a dual holocam can focus on objects up to 25 meters distant and record in holographic mode. Objects more than 25 meters distant are too far for the dual holocam's 1.7 meter baseline, and the operator must detach the repeater lens and position it by hand in order to capture holographic images. The dual holocam's extension boom folds into a compact fairing with the rest of the camera, taking up no more space than a standard shoulder-mounted vidcam.

B. Minicam. The smallest commercially available video recorder, the minicam can be mounted to a helmet, a belt, or held in the palm. Like the other vidcams described here, it records to a standard 3D crystal.

C. Vidcam. Simply an improved version of the PL 5 video camera, the Gravity Age version of this device records straight to a 3D disk that can be played in any vidviewer, computer, or data slate. The model described here is a light shoulder-carried version with a back-carry sling included; the user can let the camera hang over his shoulder blade when he's not shooting.

COMPUTERS

AI SYSTEMS CSA891081

Class: Computers

Availability: Restricted

Cost: (A) \$15,000; (B) \$3,500; (C) \$4,000+

Mass: (A) 100 g; (C) 2 kg

Dim: (A) 8 cm × 5 cm × 4 mm

(C) 100 cm × 8 cm × 2 cm

A. AI Board. An artificial intelligence requires some very specialized hardware. The AI board is a computer card that allows a mainframe of Good or better quality to support a true artificial intelligence. (The AI program is sold separately; refer to Chapter 10 of the *ALTERNITY Player's Handbook*.) When an AI is loaded onto a system, all of the system's available active memory slots are filled—but the AI can freely use any programs in the com-

puter's storage memory just as a human character might employ her own skills.

B. AI Emulator Program. Artificial intelligence is extremely expensive, but the AI emulator is a good compromise. It's not a true AI, but a very sophisticated interface that relies on a library of programmed responses to simulate an independent personality and consciousness. The AI emulator requires 4 slots of active memory, but it provides a -1 step bonus to any other programs a hero wants to run on the machine due to its user-friendly interface and aggressive problem-solving features.

C. Memory Harness. Most AIs are tied to their home system; unlike a human character, an AI can't get up and walk around to investigate situations in person. The memory harness is a portable computer system equivalent to a computer gauntlet of similar quality—a Good memory harness, for instance, has the same number of active memory slots and the same functions as a Good computer gauntlet. In addition, the memory harness is equipped with special fuzzy-logic banks to contain a working echo of a larger artificial intelligence. Basic audio and optic sensors, along with datastream-capable comm gear, allow the AI to stay in touch with the wearer of the harness.

An AI maintains its normal personality and functions while downloaded into a memory harness, but it usually operates at a penalty: +3 steps for a Marginal (\$4,000) harness, +2 for an Ordinary (\$5,000) harness, +1 for a Good (\$6,000), and no penalty for an Amazing (\$8,000) harness. (The Ability Scores for an AI are cut in half, rounded up, when the AI is loaded into a memory harness; see Chapter 10 of the *ALTERNITY Player's Handbook*.)

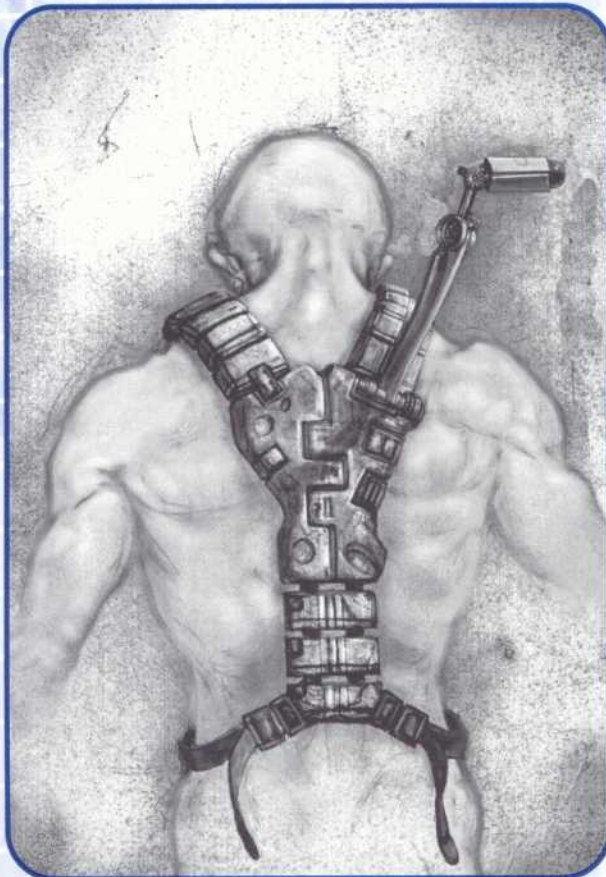

Memory Harness

BUSINESS SYSTEMS CSB390712

Class: Computers

Availability: Controlled

Cost: \$1,500+ (see below)

Mass: (A) 6 kg; (B) 500 g

Dim: (A) 40 cm × 30 cm × 15 cm

(B) 20 cm × 15 cm × 5 cm

A. Mainframe. This powerful computer can handle almost any business task, from high-end data management and research applications to inventory or payroll control. Many starships use a modified mainframe as a computer core. The mainframe comes in both tower and desktop designs, with an integrated high-definition vid-screen that stows in the casing when not in use. Most mainframes include a 3D drive, an indelible drive back-up, and a datastream jack for connection to comm systems.

The cost and capacity of a mainframe varies with the quality of the machine:

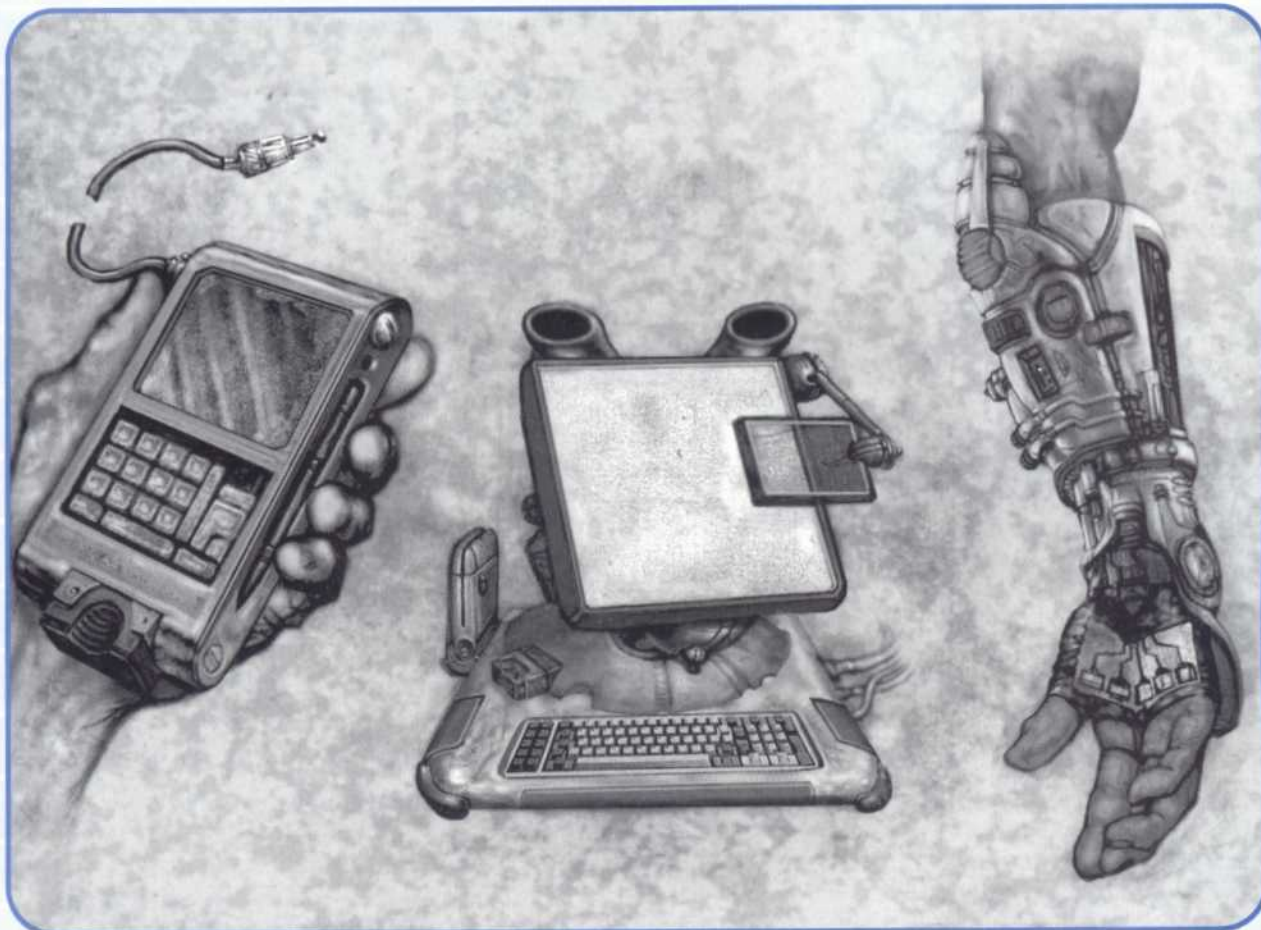

Personal Computers (L-R): Data Slate, Desktop, Gauntlet

Quality	Cost	Active Memory	Cost: \$250+ (see below)
Marginal	\$4,500	9 slots	Mass: (A) 300 g; (B) 3 kg; (C) 2 kg
Ordinary	\$9,000	12 slots	Dim: (A) 15 cm × 8 cm × 1 cm
Good	\$14,000	15 slots	(B) 30 cm × 20 cm × 10 cm
Amazing	\$20,000	unlimited	(C) 35 cm × 12 cm × 10 cm

B. Microcomputer. The businessman's traveling computer, is smaller, lighter, and more powerful than the laptops of earlier days. It's comparable to a computer gauntlet (see below), but microcomputers cost less than gauntlets since they don't need as many special displays or controls. Each machine has a 3D drive and a datastream jack for connection to phone or comm systems. Like mainframes, microcomputers vary in cost and power:

Quality	Microcomp	Gauntlet	Active Memory
Marginal	\$1,500	\$2,000	3 slots
Ordinary	\$2,500	\$3,000	5 slots
Good	\$3,500	\$4,000	7 slots
Amazing	\$4,500	\$5,000	9 slots

A. Data Slate. In the Gravity Age, over 90% of the adult population owns at least one data slate. Not only do data slates serve as personal planners, computers, checkbooks, email boxes, and notepads, most people use data slates as 3D readers for magazines, novels, videos, and entertainment software. Data slates have a 3D drive, a datastream jack, and a touchscreen interface. Data slates come in pocket, purse, wristwatch, clipboard, and belt-worn styles.

Quality	Cost	Active Memory
Marginal	\$250	2 slots
Ordinary	\$500	3 slots
Good	\$750	4 slots
Amazing	\$1,000	6 slots

PERSONAL SYSTEMS CSP097455

Class: Computers
Availability: Controlled

B. Desktop Computer. Doubling as a video viewer, communications station, workplace, and entertainment device, the desktop computer is a standard feature of any

middle-class or upper-class home and most places of business. Even lower-class abodes are likely to have a battered old desktop just to stay in touch. Desktops come with a 3D drive and a datastream jack.

Quality	Cost	Active Memory
Marginal	¥1,000	4 slots
Ordinary	¥2,000	6 slots
Good	¥3,000	8 slots
Amazing	¥4,000	10 slots

C. Gauntlet. Computers in the Gravity Age are so ubiquitous and necessary that manufacturers are constantly searching for lighter and more comfortable platforms. The computer gauntlet is one of the newer and more popular models. This device appears as a forearm-mounted keyboard and flatscreen. It includes a 3D drive, a datastream jack, and a built-in pointer interface—a mouse device operated by the hand on which the gauntlet is worn. The computer gauntlet's cost and power are summed up on the previous page, under the microcomputer entry.

PROFESSIONAL GAUNTLET CSP290711

Class: Computers
Availability: Controlled
Cost: ¥1,000+ (see below)
Mass: 2 kg
Dim: 35 cm × 12 cm × 10 cm (approx.)

A. Medical Gauntlet. Based on the computer gauntlet (see above), this model sacrifices some processor power in exchange for a compact suite of medical scanners and materials. In addition to the onboard computer and medical programs, the gauntlet includes a blood sampling and testing module, a magnetic resonating scanner module, and first aid supplies equivalent to a trauma pack I (see page 22). The gauntlet provides a -1, -2, or -3 step bonus (for an Ordinary, Good, or Amazing-quality device) to the user's Medical Science or first aid skill checks.

The medical gauntlet's computing power varies by quality, as shown below:

Quality	Medical	Professional	Active Memory
Marginal	¥3,000	¥1,000	3 slots
Ordinary	¥4,000	¥2,000	5 slots
Good	¥5,000	¥3,000	7 slots
Amazing	¥6,000	¥4,000	9 slots

B. Professional Gauntlet. Like the medical gauntlet, a professional gauntlet is a variation on the computer gauntlet that sacrifices processor power in exchange for sensors or interfaces that are especially useful in another field. Most of these are less extensive than the sophisticated suite of a medical gauntlet, so professional gauntlets

are generally much cheaper. A professional gauntlet provides a -1, -2, or -3 step bonus to the appropriate skill checks. Available models include:

Ops Gauntlet: Equipped with a console interface, the ops gauntlet aids in System Operation skill checks.

Pilot Gauntlet: Nav modules and reflex boosters aid in Vehicle Operation and Navigation skill checks.

Science Gauntlet: The gauntlet includes databases in all scientific fields, providing a bonus to Life Science, Physical Science, or Technical Science skill checks.

Tactics Gauntlet: This gauntlet includes special terrain displays, comm gear circuits, and weapon readouts that allow an officer to track the location of soldiers under his command and coordinate their efforts. It aids Tactics and Leadership skill checks.

Security Gauntlet: Fitted with a broadband emission detector to detect electric eyes and internal comms, this gauntlet aids Security skill checks.

GRIDWARE CSG300696

Class: Computers
Availability: Controlled
Cost: ¥1,000+ (see below)
Mass: (A, B) 2 kg; (C) 500 g.
Dim: (A) 35 cm × 12 cm × 10 cm (approx.)
(B) 20 cm diameter × 15 cm tall
(C) 10 cm × 5 cm × 2 cm

A. Gridcaster Gauntlet. The gridcaster is simply a powerful computer gauntlet with a special neural interface jack designed to mate with the wearer's cytronic circuitry. It provides a -1, -2, or -3 step bonus to Computer Science skill checks for a gauntlet of Ordinary, Good, or Amazing quality.

Quality	Gauntlet	Helmet	Active Memory
Marginal	¥1,500	¥2,500	4 slots
Ordinary	¥2,500	¥4,500	7 slots
Good	¥4,000	¥6,500	10 slots
Amazing	¥6,000	¥8,500	12 slots

B. Gridcaster Helmet. The gridcaster helmet resembles the gridcaster gauntlet in all important details, except that it doesn't have any kind of external interface; it's operated through the wearer's NIJacks. The helmet provides a +1 point increase to all Ability Scores generated for a shadow while wearing the device, but the user is oblivious to the outside world while immersed in the Grid.

C. Homesite Unit. Millions of people maintain personal or business-oriented homesites, analogous to the websites of the Information Age. However, a homesite is far more complex and personalized than an old-fashioned web address; it's a complete virtual environment tailored to its owner's taste, a form of expression and creativity in

which any educated person with the inclination and the means can be the master of his own world.

The homesite unit is a special segregated piece of hardware through which Grid visitors can reach the user's system. It operates independently of the base system; active around the clock, it's a message system, a business tool, and a first line of defense against hostile hackers. The unit provides a bonus to defensive programs, Grid utilities, or shadow programs run by the homesite's owner:

Quality	Homesite Cost	Grid Op Bonus
Marginal	\$1,000	None
Ordinary	\$1,500	-1 step
Good	\$2,500	-2 steps
Amazing	\$5,000	-3 steps

HARDWARE CSA349065

Class: Computers

Availability: Controlled

Cost: (A) \$100; (B) \$350; (C) \$875; (D) \$400

Mass: (A, C, D) 100 g; (B) 2 kg

Dim: (A, C, D) 10 cm × 5 cm × 2 mm

(B) 30 cm × 15 cm × 8 cm

A. Datastream Link. The PL 7 version of a modem, the datastream link is a communication connection that allows the computer to transmit or receive information and commands via direct data transfer. Almost all PL 7 computer systems include a datastream link.

B. Dataprinter. The all-purpose output device of the Gravity Age, the dataprinter combines printer, fax, copier, and scanner. In many places, it is almost obsolete—direct Grid transmission of data obviates the need for bulky printouts or tedious scanning jobs.

C. Indelible Drive. This is a backup device that uses a laser scribe to permanently mark a 3D chip with a record of all transactions that occur on a particular system. Once recorded, nothing can be done to change the drive's history. Of course, indelible drives can simply be destroyed, or the 3D crystal library disposed of in a number of ways, but short of physical removal or destruction there's no way to falsify the indelible drive—making it a vital backup for contracts, financial transactions, legal records, etc.

D. Vocal Interface. Keyboards, pointers, and touchpens are common interface devices on the computers of the Gravity Age, but many also use a vocal interface—an input/output device by which the computer can understand spoken commands, and report via audio speakers. Vocal interfaces are favored by people who like “fuzzy logic” systems or old-fashioned thinking aloud; they're also useful since a vocal interface is a “hands-off” device that doesn't require the physical proximity or direct attention of the user.

CYBERWARE

CYBERWARE, SENSORY CYS100873

Class: Cybernetics

Availability: Controlled

Cost: See below

Mass: (A, B) 100 g; (C) 350 g

Dim: (A, B) 2 cm × 2 cm × 1 cm

(C) 4 cm × 3 cm × 2 cm

A. Artificial Ear. The artificial ear is a sensitive microphone capable of detecting extremely low and high frequency sound normally outside the human hearing range, such as sonar transmissions or dog whistles. His hearing is “magnified” as shown below, and he gains a bonus to skill checks that involve the ability to detect sound, such as *Awareness-intuition* checks to avoid surprise, *Manipulation-lockpick* checks against locks with tumblers, and so on. If the subject has two artificial ears, he can use the skill check bonus to offset darkness-related combat penalties due to his ability to locate his foe through sound.

Quality	Cost	Mag.	Skill Bonus	Size
Ordinary	\$1,000	×10	-1 step	1
Good	\$2,000	×25	-2 steps	1
Amazing	\$4,000	×50	-3 steps	1

B. Artificial Eye. This device is a video imaging system that replaces one of the user's own eyes. It provides magnification as described on the table above, and a bonus to skill checks in which visual acuity may be important, such as *Investigate-search* or *Awareness-perception*. For double the listed cost, an artificial eye includes image-enhancing or thermal technology, conferring the benefits of imaging goggles or thermal goggles in addition to simple magnification.

C. Scanner Implant. The scanner implant is a magnetic resonance device that can be installed in the user's eye or hand. It provides the cybernetic character with the ability to see into or through walls or objects, as long as he is within 1 meter of the object to be scanned. (See page XX for details on the magnetic scanner and weapon detector.) The better the implant, the lighter and less intrusive it is, as shown below.

Quality	Cost	Size
Ordinary	\$1,250	2
Good	\$2,500	1
Amazing	\$3,750	—

CYBERWARE, STRUCTURAL CYB205065

Class: Cybernetics
Availability: Controlled
Cost: See below
Mass: (A, B) 15 kg; (C) 4 kg
Dim: varies

A. Endoskeleton. One of the most difficult pieces of cyberware to install, the endoskeleton provides all of the benefits of a cybernetic exoskeleton—but it's hidden inside the user's body. Large portions of the user's natural skeleton are replaced or reinforced with carbonide alloy structural members. The endoskeleton can anchor cybernetic limbs, MusclePlus, and similar systems just like the exoskeleton, and it provides the user with 3 extra stun/wound/mortal points for Ordinary, Good, or Amazing-quality implants.

B. Subdermal Armor. Consisting of flexible CF bands inserted over the vital portions of the body, subdermal armor is much less obvious than body plating. It doesn't have the stopping power of external armor, but it doesn't affect the user's agility and doesn't advertise his special edge. Ordinary armor stops d4-1 (LI), d6-2 (HI), d6-2 (En); Good armor stops d6-1 (LI), d8-3 (HI), d8-2 (En); and Amazing armor stops d6+1 (LI), d6 (HI), d6 (En).

C. Systemic Reinforcement. This piece of cyberware serves to effectively increase a character's cyber tolerance score. The subject's vital functions—breathing, circulation, immune responses, etc.—are supplemented by noninvasive synthetic systems. Systemic reinforcement adds 1, 2, or 3 points to the subject's cyber tolerance score for an Ordinary, Good, or Amazing piece of equipment.

System	Size	Ordinary	Good	Amazing
Endoskeleton	3	\$4,000	\$6,000	\$8,000
Subdermal Armor	2	\$1,500	\$3,000	\$6,000
Syst. Reinforcement	—	\$5,000	\$10,000	\$15,000

CYBERWARE, IMPLANT CYI507539

Class: Cybernetics
Availability: Controlled
Cost: (A) \$1,500; (B) \$3,500; (C) varies
Mass: (A) 100 g; (B) 3 kg; (C) varies
Dim: (A) 2 cm × 1 cm × 5 mm
(B, C) varies
Size: (A) 1; (B) 2; (C) 2, 3, or 4

A. Cortex Bomb. The cortex bomb is one of the most brutal means available of ensuring compliant behavior. It's a small radio-activated or timed explosive charge,

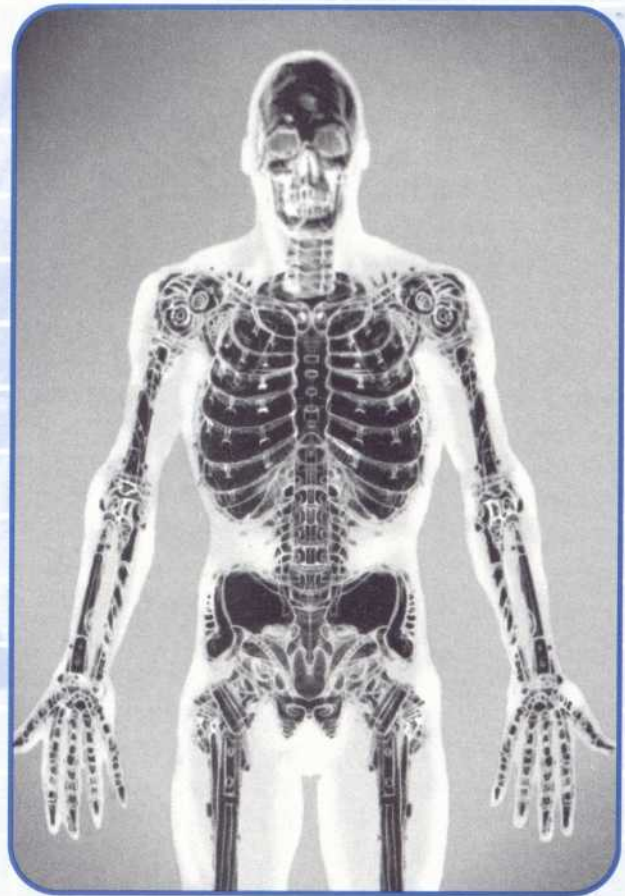

Endoskeleton

implanted in the subject's skull. If detonated, the bomb kills the victim in a grisly display. Radio detonators must be within 200 meters to function; cluttered terrain or interior walls may reduce this substantially. Removing a cortex bomb is possible, but if the surgeon achieves a Critical Failure, the bomb goes off, causing d4m to the surgeon and anyone else within 5 meters of the victim.

B. Deflection Web. This is simply a deflection inducer installed in the subject's body. When activated, it increases the subject's resistance modifier against physical or energy attacks by +2, but hinders the subject's own attacks with a +1 step penalty. The web's endurance is only 5 rounds; the charge pack is usually hidden on the calf or upper arm, and changing it requires an entire round.

C. GP (General Purpose) Implant. Almost any piece of gear imaginable can be installed in a general purpose module. Items weighing 1 kg or less can be installed with Ordinary implants; items weighing up to 3 kg are Good implants; and items weighing up to 10 kg are Amazing implants. Powered items include power leads that the character can use to recharge his internal batteries. Common items chosen for GP implants include gauntlets, cutting torches, vidcams, flashlights, zero-g webs, and powered grapnels.

General purpose implants cost \$500, \$1,000, or

€2,000 for Ordinary, Good, or Amazing modules, plus twice the cost of the equipment to be installed.

CYBERWARE, INTERFACE CYF290349

Class: Cybernetics
 Availability: Controlled
 Cost: (A) €500+; (B) €1,500+; (C) €1,000+
 Mass: (A) 100 g; (B, C) 300 g
 Dim: (A) 2 cm × 1 cm × 5 mm
 (B, C) 3 cm × 2 cm × 1 cm
 Size: (A) —; (B) —; (C) 1

A. Comm Port. This is a frequency-agile transceiver hardwired to the user's nanocomputer. Through the port, the user can receive and transmit comm signals, video feed (if he has an optic system), or datastream feed. Using a comm port for a radio conversation is distracting, so the character suffers a +1 step penalty to actions he takes while communicating. Unlike the subdermal transceiver, which takes its cues from subvocalizations, the comm port is controlled directly by the wearer's mind through his nanocomputer. The comm port has a range of 20/50/200 km for an Ordinary, Good, or Amazing installation.

B. Gunsight. There are three components in this system: a vidcam mounted on the wearer's weapon, a wire lead from the vidcam to the wearer's cytronic circuitry, and an optic screen, artificial eye, or cyberoptic system in the user's head (not included in the package). When activated, the vidcam projects crosshairs in the user's field of vision, showing exactly where the gun is pointing. The system provides a -1, -2, or -3 step bonus to the user's attack skill checks with the ranged weapon in question. The cybernetic gunsight is especially deadly when used in conjunction with an enhance program.

C. System Link. Resembling the innate mechalus ability to directly interface with computer hardware, the system link is an extension of the user's cytronic circuitry net that can bypass manual controls, keyboards, or displays. The user delivers commands to the vehicle or system in question through a direct neural link, speeding his reactions and increasing his precision. The link provides a -1, -2, or -3 step bonus to one specialty skill under Vehicle Operation or System Operation. This bonus is not cumulative with any bonus for the quality of a vehicle's on-board computer. Additional specialty modules can be purchased for €500 each.

System	Ordinary	Good	Amazing
Comm Port	€500	€1,500	€2,500
Gunsight	€1,500	€2,500	€4,500
System Link	€1,000	€2,000	€4,000

CYBERWARE, COMMAND CYC208442

Class: Cybernetics
 Availability: Controlled
 Cost: (A) €2,500+; (B) €1,000+
 Mass: (A) 75 g; (B) 150 g
 Dim: (A) 2 cm × 2 cm × 2 mm
 (B) 5 cm × 3 cm × 5 mm
 Size: (A) —; (B) 1

A. Accelerator. The accelerator uses the subject's cybernetic control systems to drastically enhance his reaction speed. The recipient must have reflex wiring (see Chapter 15 in the *ALTERNITY Player's Handbook*) and a nanocomputer to support the accelerator, or the device is useless. The accelerator provides the following benefits:

Quality	Action Check Score Increase	Actions/Rd Increase	Cost
Ordinary	+2	None	€2,500
Good	+3	+1	€5,000
Amazing	+4	+2	€10,000

In order to receive the accelerator bonus, the character's nanocomputer and reflex wiring must be of equal or better quality. Otherwise, the accelerator is limited in its effect to the weakest of the three systems. For example, a character with an Amazing accelerator, Good reflex, and an Ordinary nanocomputer only gains the Ordinary accelerator benefits. Using an accelerator doubles the stun damage inflicted by triggering an enhance program.

B. Nanocomputer. Without a nanocomputer and its cytronic circuitry, most other pieces of cyberware are useless. The nanocomputer provides an interface between the subject's central nervous system and his cyberware, allowing him to control cyberlimbs, deploy weaponry, etc. Each cybernetic system requiring conscious control takes 1 of the nanocomputer's active memory slots, so a character with two cyberlimbs and a BattleKlaw must allocate 3 of his nanocomputer's slots to the direction of his cyberware. Nanocomputers cannot read 3Ds, download data, or otherwise interact with the world around the character unless some kind of interface device is purchased and installed—a NIJack, a 3D drive, or a comm port.

Quality	Cost	Active Memory	Processor Bonus
Marginal	€1,000	3 slots	None
Ordinary	€2,000	4 slots	-1 step
Good	€3,000	5 slots	-2 steps
Amazing	€4,000	6 slots	-3 steps

MERRICK'S PERSONAL SECURITY REPORT

For over one hundred years, Merrick's of Powder has been acknowledged as the definitive source of reliable and current information on the latest developments in personal weaponry. Its yearly 3D publication sells millions of copies throughout the Stellar Ring and the Verge, and for those who can't wait until the next release, Merrick's also publishes quarterly updates to its current report. The latest issue listed more than two hundred thousand models of firearms, energy weapons, weapon modifications and accessories, and body armor, representing twenty-nine hundred different manufacturers. (Unfortunately, we can only mention a small fraction of all that hardware in this sample printout.)

Merrick's of Powder was founded in 2336 by Colonel Jane Merrick, an Austrin-Ontis retiree who wanted to provide an unbiased and complete listing of weapon models in service throughout human space. A lifetime gun fanatic, Colonel Merrick had served with distinction in the Ordnance Branch of the A-O military for thirty-three years. Her last post was Director of Testing, a position in which she personally oversaw the exhaustive field and range testing of every new A-O model, in addition to thousands of weapons belonging to non-Austrin arms manufacturers.

Colonel Merrick's Report began as a small-press industry journal and informational database for Austrin-Ontis executives and other gun enthusiasts. Her personal experience, comprehensive testing, and impeccable standards soon made the Report an indispensable resource to anyone interested in state-of-the-art personal weaponry and defense systems. In the year after Colonel Merrick's death (2370), the Report made its first transstellar publication. Today, it's the largest and most reputable of a host of related publications.

The report consists of a single X3D crystal costing \$75, with an onboard navigator to help the user browse

or research any weapon he's interested in. Unlike the Rignomor Star Consortium Merchant Exchange or VoidCorp's *CompuCatalog One*, it's not a commercial advertisement; Merrick's lists manufacturers' addresses and homesites, but doesn't provide current prices, order information, or a datastream messaging utility. (The cost figures provided as part of the statistics for each entry are meant merely as guidance for the reader and should be taken as rough estimates only. Actual prices may vary widely from system to system.) Merrick's also publishes a top-notch hard copy, a series of hardbound books consisting of nearly three thousand pages of the most important personal weapon systems available today. The hardbound version costs \$50 per volume, with a six-volume set per year and a \$25 quarterly update in magazine format.

IN THE VERGE

A very serious and deadly arms race is under way in the worlds of the Verge, as eighty years of progress in the state of personal weaponry crashes in all at once. The long isolation imposed by the Second Galactic War prevented the Vergers from staying up to date with the latest weapon systems, tactics, and developments. While the major Verge worlds pursued their own weapons programs, the general population was equipped with weapons as much as a century out of date—and there's a rush of arms dealers, purchasing agents, and military designers who want to change that. Merrick's Personal Security Report is the best resource available for these entrepreneurs and officers.

The Concord staunchly opposes the flood of legal and illegal weapons pouring into the Verge, and is calling for exhaustive licensing and registration to prevent large quantities of powerful arms from falling into the wrong hands. But it's already too late. Representatives of dozens of major arms manufacturers are flitting from place to place in the Verge, courting system governments, paramilitary agencies, private corporations, and the general public. For every legal arms dealer, there are a dozen gunrunners and black market racketeers who are making a fortune from rearming the Verge. Nowhere is the arms race more conspicuous than in the war-torn Algemron system, where the governments of the planets Alitar and Galvin aggressively pursue any edge they can cultivate, each trying to obtain and maintain the upper hand in their decades-old war.

CAMPAIGN TIPS

The gunrunning trade is lucrative, but risky. Heroes might be assigned the job of shutting down the operation of a major arms dealer, operating as agents of the Concord . . . or as dupes of the competition. Intercepting shipments, tracking down suppliers and buyers, and dealing with corrupt bureaucrats who have been bought by the arms dealers might provide a number of good adventure ideas. On the other hand, heroes with an entrepreneurial streak and a loose code of ethics might choose to make their fortunes by running guns to the outlying reaches of the Verge.

HAND-TO-HAND ENERGY WEAPONS

Weapons in this class rely on contact-delivered energy to stun or incapacitate the opponent. Since mass or cutting edge is simply a secondary characteristic of the device, most melee weapons of this group are light and easy to use.

SAMURAI 300 ION BLADE

Koshimi Industries
Availability: Military
Cost: \$750
Mass: 2.25 kg
Length: 65 cm
Payload: Ionizing energy
Accuracy: 0
Actions: 4
Type/Firepower: En/0
Damage: d4+3s/d6+4s/d4+3w
Range: Personal
Hide: +2
Clip/charge Size: 10
Clip/charge Cost: \$75
Skill: *Melee Weapons-powered*



The ion blade delivers a discharge of electromagnetic energy on contact. While it's moderately effective against unarmored targets, its primary purpose is to neutralize heavy body armor, robots, and cybernetics. A target that relies on electronic control systems or computers suffers a +2 step penalty to any *Stamina-endurance* checks he (or it) must make after being struck by an ion blade.

NIGHTHAWK A5 PULSE BATON

SekureTek Group
Availability: Controlled
Cost: \$500
Mass: 1.15 kg
Length: 50 cm
Payload: Electrical shock
Accuracy: 0
Actions: 3
Type/Firepower: En/0
Damage: d8s/d4+2w/d6+2w
Range: Personal
Hide: +4

Clip/charge Size: 10
Clip/charge Cost: \$75
Skill: *Melee Weapons-powered*



Pulse batons have been in use for more than a century. Few unarmored targets can stand up to more than one or two shocks from its powerful capacitors. The Nighthawk is a telescoping stealth model made from low-density plastics. It's extremely concealable and does not show up on most weapon detectors, allowing the user to smuggle it into places he might not normally be armed.

PUNKTHUMPER 6000 STUN BATON

SekureTek Group
Availability: Common
Cost: \$425
Mass: 2 kg
Length: 45 cm
Payload: Electrical shock
Accuracy: 0
Actions: 3
Type/Firepower: En/0
Damage: d6+1s/d8+2s/d12+3s
Range: Personal
Hide: +2
Clip/charge Size: 10
Clip/charge Cost: \$75
Skill: *Melee Weapons-powered*

Hundreds of models of stun batons are available, but Merrick's awards its prestigious Triple-Bullseye rating to the PunkThumper 6000 as the best of its class. Intended for serious restraint work, the PT 6K uses an extra-heavy pulse baton battery to deliver the biggest stun-sized jolt around. It doesn't last as long as a standard stun baton's charge, but with the PunkThumper each hit counts.

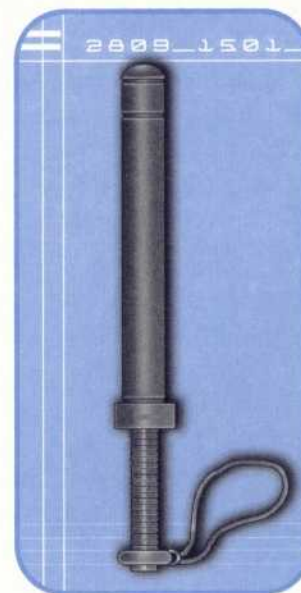

HAND-TO-HAND HYPERBLADES

The term "hyperblade" refers to any fighting weapon with a super-sharp molecular blade. Through modern nano-engineering techniques, it's possible to construct blades thousands of times sharper than anything found in nature. Hyperblades are more lethal than many firearms, and the best close-quarters weapons around.

AX2 CHAINWORD

Pulan-Tough Job Corporation
 Availability: Military
 Cost: \$1,250
 Mass: 7 kg
 Length: 115 cm
 Payload: Monomolecular edge
 Accuracy: +1
 Actions: 2
 Type/Firepower: LI/G
 Damage: d8+1w/d8+2w/d4+1m
 Range: Personal
 Hide: —
 Clip/charge Size: 8
 Clip/charge Cost: \$125
 Skill: Melee Weapons—*powered*

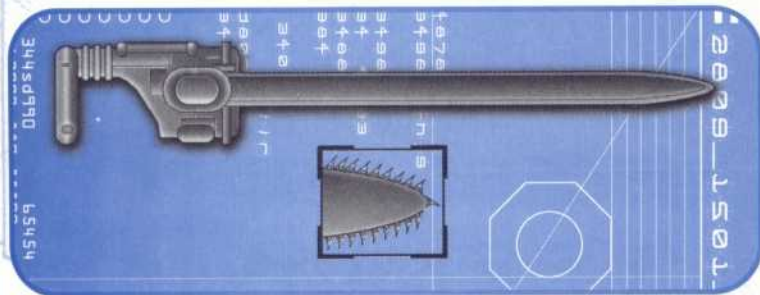

The chainsword is heavy and unwieldy, but it delivers outstanding damage in hand-to-hand combat. Its fighting edge is a chain-driven array of serrated, microengineered teeth, capable of cutting through almost any normal material. (In fact, the chainsword serves as a decent concrete saw in a pinch.) The AX2 is a heavy-duty model designed for use against heavily armored targets.

VIPER D FILAMENT BLADE

Dietterlich Industries
 Availability: Controlled
 Cost: \$1,500
 Mass: 1.75 kg
 Length: 30–400 cm
 Payload: Molecule chain edge
 Accuracy: 0
 Actions: 3
 Type/Firepower: LI/0



Damage: d8–1w/d8w/d12–1w
 Range: 4 meters
 Hide: +2
 Clip/charge Size: 20
 Clip/charge Cost: \$75
 Skill: Melee Weapons—*powered*

A filament blade's fighting edge is a single strand of monomolecular carbonate fiber. The weapon consists of a hilt and a small, free-floating lead module, between which the monofilament is stretched. The lead module senses the user's swings and maneuvers accordingly, keeping the filament taut at all times. The weapon can be set for a length of up to 4 meters for melee attacks against distant targets.

T-BAR TN BLADE

StarMech Edge One Division
 Availability: Common
 Cost: \$500
 Mass: 4 kg
 Length: 35 cm
 Payload: Conventional blade
 Accuracy: 0
 Actions: 4
 Type/Firepower: LI/G
 Damage: d6w/d6+1w/d4m
 Range: Personal
 Hide: +3
 Clip/charge Size: n/a
 Clip/charge Cost: n/a
 Skill: Melee Weapons—*blade*

TN stands for tungsten-neutronite. It's the toughest conventional alloy known, capable of punching through cerametal or vanadium steel like an iron crowbar through tin foil. This weapon is a large combat knife, but it's far denser (and heavier) than a conventional blade. The TN knife is the only nonpowered weapon capable of piercing powered attack armors such as the body tank.



HAND-TO-HAND GRAVITONIC WEAPONS

Gravitonic weapons make use of the continuing miniaturization and development of gravity induction technology. These devices rely on smart sensors that vary the weapon's mass, allowing a skilled user to strike monstrosously powerful blows with no more effort than it takes to swing a conductor's baton.

THUNDER 150 GRVMACE

ThunderCorp Arms, Ltd.
Availability: Controlled
Cost: \$850
Mass: 3 kg
Length: 90 cm
Payload: Variable mass head
Accuracy: 0
Actions: 3
Type/Firepower: LI/O
Damage: d8+2s/d6+2w/d8+2w
Range: Personal
Hide: +1
Clip/charge Size: 10
Clip/charge Cost: \$75
Skill: Melee Weapons—powered

The gravity mace (or gravmace, as it's more commonly known) is a popular weapon among many front-line assault troops. It's lighter and faster than the chainsword, and even if it lacks the chainsword's hitting power, the gravmace's combat battery lasts twice as long. The Thunder 150 is a standard model found in the inventory of several stellar nations and a number of private security firms.



HEADBUSTER POWER CESTUS

SekureTek Group
Availability: Controlled
Cost: \$625
Mass: 2 kg
Length: 15 cm
Payload: Variable mass head
Accuracy: 0
Actions: 4
Type/Firepower: LI/O
Damage: d4+2s/d4w/d4+2w
Range: Personal

Hide: +3
Clip/charge Size: 12
Clip/charge Cost: \$50
Skill: Unarmed Attack—brawl

Winner of the Merrick's Triple-Bullseye, the HeadBuster is the best power cestus available. It's lighter and more concealable than most power cesti, but provides the same hitting power. The HeadBuster is so easy to use that most wielders require no formal training in powered weapons; the wielder can choose to use either his Melee Weapons or Unarmed Attack skill when attacking with the HeadBuster.



K-3 ZERO-G AXE

ThunderCorp Arms, Ltd.
Availability: Military
Cost: \$950
Mass: 4 kg
Length: 110 cm
Payload: Variable mass blade
Accuracy: +1
Actions: 3
Type/Firepower: LI/O
Damage: d6+2w/d4+4w/d4+2m
Range: Personal
Hide: -
Clip/charge Size: 10
Clip/charge Cost: \$100
Skill: Melee Weapons—powered

The zero-g axe is a powered weapon specialized for use in boarding actions and microgravity situations. At the bottom of its haft, a counterweight compensates perfectly for the variable mass of its deadly carbonite blade. The weapon negates two steps of light-gravity or zero-g combat penalties, allowing a user with magnetic boots or the Acrobatics—zero-g training skill to make melee attacks with no penalty.



HAND-TO-HAND NONPOWERED WEAPONS

Thousands of conventional hand-to-hand weapons can still be found within the borders of the Stellar Ring. Some are collectors' pieces, carried only by the fashionable or eccentric. Others are so simple and easy to manufacture that they'll never go out of style; clubs and knives are likely to stay around as long as humankind does.

CHUURKHNA

Weren melee weapon
Availability: Common
Cost: $\$350$
Mass: 7 kg
Length: 160 cm
Payload: Conventional blade
Accuracy: 0
Actions: 3
Type/Firepower: LI/0
Damage: d4+3w/d6+3w/d6m
Range: Personal
Hide: -
Clip/charge Size: n/a
Clip/charge Cost: n/a
Skill: Melee Weapons-*blade*



An ancient weren design, the chuurkhna is still favored by members of that race. It's a glaive or halberd with a haft about a meter and a half long. Its blade is large and heavy, intended for chopping rather than thrusting. A weren can wield it one- or two-handed, but most humans would have to use both hands to control it. Weren have been known to drive chuurkhnas through the heaviest body armor.

DAIT'SYA

T'sa melee weapon
Availability: Common
Cost: $\$250$
Mass: 1 kg
Length: 25 cm
Payload: Conventional blade
Accuracy: 0
Actions: 4

Type/Firepower: LI/0
Damage: d4+1w/d4+2w/d4+3w
Range: Personal
Hide: +2
Clip/charge Size: n/a
Clip/charge Cost: n/a
Skill: Melee Weapons-*blade*



The dait'sya is a traditional t'sa weapon, a double-bladed dagger held in the wielder's closed fist. They're always used in pairs (the listed cost, mass, and damage is for two weapons). Combined with the lightning speed of most t'sa, the dait'sya is especially dangerous in close-quarters combat. Because of the dait'sya's light design, any penalties for fighting with a weapon in each hand are reduced by 1 step.

TONG FE

Police fighting stick
Availability: Common
Cost: $\$60$
Mass: 1 kg
Length: 45 cm
Payload: Conventional blunt
Accuracy: -1
Actions: 4
Type/Firepower: LI/0
Damage: d6s/d6+2s/d4+1w
Range: Personal
Hide: +2
Clip/charge Size: n/a
Clip/charge Cost: n/a
Skill: Melee Weapons-*bludgeon* or
Unarmed Attack-*power martial arts*

The tong fe is a martial arts weapon that has become the fighting stick of choice for many police and security forces. Designed specifically for parrying, the tong fe adds a -2 step bonus to any parrying effort the user attempts. As with the dait'sya, experts often wield two of these weapons at once; the tong fe reduces the penalties for attacking with two weapons at once by 1 step.



CHARGE PISTOLS

The final evolution of the conventional firearm, charge weapons replace the old firing-pin mechanism of earlier guns with an electrical action. Charge weapons are sturdy, reliable, and cheap compared to more advanced personal weapons, and are still extremely popular in many regions.

M9 9MM CHARGE PISTOL

A.M. Industries, Orion League

Availability: Common

Cost: \$500

Mass: 1 kg

Length: 18 cm

Payload: 9mm bullet

Accuracy: -1

Actions: 4

Mode: F

Type/Firepower: HI/O

Damage: d4+1w/d6+1w/d4m

Range: 8/16/60 meters

Hide: +3

Clip/charge Size: 15 rounds

Clip/charge Cost: \$50

Skill: Modern Ranged Weapons—*pistol*



The M9 charge pistol has been the standard sidearm of the Orion Star Service for more than eighty years. More than two million M9s have been produced by

A.M. Industries. It's a good example of a light charge pistol, equipped with a baffled suppressor to hide the weapon's characteristic muzzle flash. In recent years, the Star Service has begun a design competition in search of a replacement for this model.

HAMMER 5 11MM CHARGE PISTOL

Soze Arms Ltd.

Availability: Common

Cost: \$1,000

Mass: 1.2 kg

Length: 22 cm

Payload: 11mm bullet

Accuracy: -1

Actions: 3

Mode: F

Type/Firepower: HI/O

Damage: d4+2w/d6+2w/d4+1m

Range: 10/20/80

Hide: +2

Clip/charge Size: 12 rounds

Clip/charge Cost: \$60

Skill: Modern Ranged Weapons—*pistol*



One of the finest 11mm pistols on the market, the Soze Hammer 5 is an unusually steady and accurate heavy pistol. It's a little large to fit comfortably in many handgun holsters, but many enthusiasts think that the weapon's legendary accuracy is worth the extra cost and trouble. Numerous models of "standard" 11mm pistols exist, generally priced around \$800 for a new gun.

K-SAT 100 9MM ZERO-G PISTOL

Karadnya-Brusilev Industries

Availability: Common

Cost: \$400

Mass: 1 kg

Length: 22 cm

Payload: 9mm bullet

Accuracy: 0

Actions: 3

Mode: F

Type/Firepower: HI/O

Damage: d4+1w/d6+1w/d4m

Range: 4/10/40

Hide: +3

Clip/charge Size: 15 rounds

Clip/charge Cost: \$50

Skill: Modern Ranged Weapons—*pistol*



The Karadnya is a vintage design that's been around for more than fifty years. A muzzle brake and recoil cylinder surrounding the weapon's action make it virtually recoil-free. Although its low muzzle velocity limits its range, the K-SAT reduces any penalties for firing in zero-g conditions by 1 step. Today, energy weapons such as the laser pistol are beginning to replace the old zero-g firearms.

CHARGE RIFLES

The most common weapon in military inventories to this day, the charge rifle and its cousins provide an excellent combination of range, rate of fire, hitting power, durability, and affordability. While more powerful energy weapons are beginning to replace the charge rifle, few can provide more firepower at a better price.

ARZ 6MM CHARGE AUTORIFLE

Karadnya-Brusilev Industries
 Availability: Military
 Cost: \$2,000
 Mass: 2.75 kg
 Length: 80 cm
 Payload: 6mm bullet
 Accuracy: -1
 Actions: 3
 Mode: B/A
 Type/Firepower: HI/O
 Damage: d6w/2d4w/d4+1m
 Range: 60/150/400 meters
 Hide: -
 Clip/charge Size: 30 bursts
 Clip/charge Cost: \$125
 Skill: Modern Ranged Weapons—*rifle*

Autorifles are light weapons with a very high rate of fire, intended for assault or support roles. The ARZ is one of the most popular of these designs; originally produced by Karadnya-Brusilev of Nariac, it's now manufactured under license in the Thuldan Empire and the Solar Union. The model shown here is fitted with the standard 100-round magazine, which provides the soldier with plenty of ammo.

BULLDOG 9MM CHARGE SMG

Dietterlich Industries
 Availability: Military
 Cost: \$1,750
 Mass: 2.25 kg
 Length: 35 cm
 Payload: 9mm bullet
 Accuracy: 0
 Actions: 4
 Mode: B/A
 Type/Firepower: HI/O
 Damage: d4+1w/d6+1w/d4m
 Range: 20/50/100 meters
 Hide: +1
 Clip/charge Size: 8 bursts
 Clip/charge Cost: \$100
 Skill: Modern Ranged Weapons—*SMG*



ARZ 6mm Charge Autorifle

The Bulldog is a fine example of a second-generation weapon. Many of the flaws of earlier charge SMGs were corrected in this design. It's compact and sturdy, standing up to the worst field conditions. The most innovative feature is a recoil suppression system that controls the natural tendency of an automatic weapon to "walk" when fired in full auto—the Bulldog's accuracy is legendary.



Bulldog 9mm Charge SMG

IF-3 11MM CHARGE RIFLE

Austrin-Ontis Munitions Div. 1
 Availability: Military
 Cost: \$1,600
 Mass: 3 kg
 Length: 95 cm
 Payload: 11mm bullet
 Accuracy: 0
 Actions: 4
 Mode: F/B/A
 Type/Firepower: HI/O
 Damage: d6+1w/d6+3w/d6+1m
 Range: 90/180/600 meters
 Hide: -
 Clip/charge Size: 30 rounds/10 bursts
 Clip/charge Cost: \$60
 Skill: Modern Ranged Weapons—*rifle* For twenty years, the



IF-3 has been the standard infantry weapon of the Concord Defense Corps and the Concord Marines. Adopted from Austrin-Ontis as the best combat rifle available at the time, the IF-3 is light, rugged, and long-ranged. With the addition of a \$50 conversion kit, the IF-3 can be configured for zero-g combat. This halves all range figures, but reduces zero-g penalties by 1 step.

OTHER CHARGE WEAPONS

The electrochemical propellant technology of charge weapons was not developed for personal firearms—it was originally applied to large guns such as howitzers and tank cannons. Over the two centuries in which charge weapons have been in the limelight, hundreds of types of firearms have made use of this technology.

AGC-7 AUTOFLECHETTE SHOTGUN

StarMech Edge One Division
 Availability: Military
 Cost: \$2,750
 Mass: 3.25 kg
 Length: 45 cm
 Payload: 25mm flechette round
 Accuracy: 0
 Actions: 4
 Mode: F/B/A
 Type/Firepower: HI/O
 Damage: d4w/d6w/d4m



Range: 10/20/50 meters
 Hide: +1
 Clip/charge Size: 15 rounds/5 bursts
 Clip/charge Cost: \$150
 Skill: Modern Ranged Weapons—*rifle*

The AGC-7 (or "Aggie," as it's affectionately known) is one of the most fearsome close assault weapons in existence. It's a fully automatic charge weapon firing 20mm flechette rounds—bundles of razor-sharp needles that shred anything they hit. Like other shotguns, it inflicts double damage to targets within short range (10 meters), and only half damage (minimum of 1 point) to targets at long range.

DEVASTATOR FLECHETTE PISTOL

Soze Arms Ltd.
 Availability: Military
 Cost: \$1,450
 Mass: 1.5 kg
 Length: 27.5 cm
 Payload: 25mm flechette round
 Accuracy: -1
 Actions: 3
 Mode: F
 Type/Firepower: HI/O
 Damage: d4w/d6w/d4m
 Range: 8/16/40 meters
 Hide: +2
 Clip/charge Size: 6 rounds
 Clip/charge Cost: \$50
 Skill: Modern Ranged Weapons—*pistol*



The Devastator is a succinct statement of the Soze Arms design philosophy—overkill is the way to go. This pistol fires a wide-pattern flechette round, shredding anything in the general vicinity. It inflicts double the listed damage at close range (8 meters or less), but only half damage for shots at long range (16 to 40 meters). The flechette pistol doesn't have the full-auto capability of the autoflechette shotgun.

KZ 160 13MM CHARGE MG

Krund Armsworks, Thulda Prime
 Availability: Restricted
 Cost: \$9,500
 Mass: 22.5 kg
 Length: 115 cm
 Payload: 13mm bullet
 Accuracy: -1
 Actions: 4
 Mode: A
 Type/Firepower: HI/G
 Damage: d8w/2d6w/d8m
 Range: 200/600/1200 meters
 Hide: -
 Clip/charge Size: 50 bursts
 Clip/charge Cost: \$2,000
 Skill: Heavy Weapons—*direct fire*

The KZ 160 is a typical heavy charge machine gun, usually employed as a crew-served or vehicle-mounted weapon. Heroes who succeed on a Strength feat check can fire the KZ 160 from the hip at a +1 step penalty, but the double-autofire penalty mentioned in the *ALTERNITY Player's Handbook* doesn't apply to this weapon—the KZ 160 is a much lighter and steadier weapon than the standard heavy charge machine gun.

SABOT GUNS

These weapons use modern superconducting technology to power a discarding-sabot slug through a magnetic accelerator that runs the length of the barrel. After the slug clears the muzzle, the sabot falls away, and a scramjet engine ignites, propelling the sabot gun slug to extreme velocities. Nothing hits harder.

TORNADO 600 15MM SABOT PISTOL

ThunderCorp Arms
 Availability: Controlled
 Cost: \$900
 Mass: 2 kg



Length: 25 cm
 Payload: 10mm sabot ramjet
 Accuracy: 0
 Actions: 3
 Mode: F
 Type/Firepower: HI/O
 Damage: 2d4w/2d4+1w/d4+3m
 Range: 10/20/100 meters
 Hide: +1
 Clip/charge Size: 6 rounds
 Clip/charge Cost: \$60
 Skill: Modern Ranged Weapons—*pistol*

Sabot pistols are big and heavy, but they're the most powerful handguns produced in any numbers. The weapon has great range for a pistol, and almost no kick—the accelerator pushes the slug out of the barrel with a smooth, nonexplosive action. The sabot pistol's lanthanide cell provides enough energy to fire four clips of ammo before it's exhausted; the cell can be recharged for \$10 or replaced for \$200.

M5 15MM SABOT RIFLE

A.M. Industries
 Availability: Military
 Cost: \$4,500
 Mass: 4 kg
 Length: 125 cm
 Payload: 10mm sabot ramjet
 Accuracy: 0
 Actions: 2
 Mode: F
 Type/Firepower: HI/O
 Damage: d4+4w/2d4+2w/d6+3m
 Range: 80/200/800 meters
 Hide: -
 Clip/charge Size: 12 rounds
 Clip/charge Cost: \$100
 Skill: Modern Ranged Weapons—*rifle*

While no one questions the sabot rifle's range or hitting power, its lack of automatic-fire capability has limited its



appeal. Other combat rifles of the day provide a greater volume of fire, longer range, or better armor penetration. Despite this, the sabot rifle is popular with scouts and colonial militias who want one-shot stopping power at range for dealing with dangerous native creatures.

RONIN 900 25MM SABOT CANNON

Koshimi Industries
Availability: Restricted
Cost: \$10,000
Mass: 10 kg
Length: 130 cm
Payload: 20mm sabot ramjet
Accuracy: +1
Actions: 2
Mode: F
Type/Firepower: HI/G
Damage: d8w/d4+1m/d6+2m
Range: 100/200/500 meters
Hide: -
Clip/charge Size: 20 rounds
Clip/charge Cost: \$200
Skill: Heavy Weapons—*direct fire*

Designed to defeat vehicles and the best personal armor, the sabot cannon is the embodiment of raw firepower. Its oversized slug can punch gaping holes in almost anything. Its only weakness is its lack of accuracy compared to other heavy weapons—the sabot cannon's round has to make hard contact to inflict damage, and doesn't offer the wide beam of a plasma cannon or the fire volume of a machine gun.

MASS WEAPONS

Mass weapons have a number of drawbacks—they're expensive, they have extremely short ranges, and the enormous power requirements limit them to a handful of shots before their batteries are dry. But they're also among the few handheld weapons with enough firepower to bring down enemies in heavy attack armor.

NOVA 6 MASS PISTOL

MRA Technologies, Inc.
Availability: Military
Cost: \$1,475
Mass: 1 kg
Length: 20 cm
Payload: Gravity point-source
Accuracy: 0
Actions: 3
Mode: F
Type/Firepower: En/G
Damage: d6w/d6+2w/d6m
Range: 2/6/12 meters
Hide: +2
Clip/charge Size: 6 shots
Clip/charge Cost: \$100
Skill: Modern Ranged Weapons—*pistol*

Made famous by the action holomovies of Jack Everstar, the Nova 6 is a top-of-the-line mass pistol. Slightly more efficient than most mass pistols, the charge cells of a Nova 6 can power up to six shots before exhausting the weapon's energy reserves.



Mass pistols are virtually useless in open terrain, but there aren't many weapons better for close-quarters combat against armored foes.

2809_1501_32





AAMG-12 MASS RIFLE

Karadnya-Brusilev Industries

Availability: Military

Cost: \$2,450

Mass: 4 kg

Length: 85 cm

Payload: Gravity point-source

Accuracy: -1

Actions: 2

Mode: F

Type/Firepower: En/G

Damage: d6+1w/d8+1w/d6+1m

Range: 4/12/30 meters

Hide: -

Clip/charge Size: 8 shots

Clip/charge Cost: \$100

Skill: Modern Ranged Weapons-*rifle*

A larger and more powerful version of the mass pistol, the mass rifle sacrifices range and rate of fire for unbeatable armor penetration. The AAMG (sometimes shortened to "am-gee") is a brand-new design from Karadnya-Brusilev, with several innovative features. It's the most accurate mass rifle on the market today, and its new charge cell technology doubles its magazine capacity compared to others of its type.

SUPERNOVA XI MASS CANNON

MRA Technologies, Inc.

Availability: Restricted

Cost: \$6,825

Mass: 8.75 kg

Length: 105 cm

Payload: Gravity point-source

Accuracy: 0

Actions: 2

Mode: F

Type/Firepower: En/G

Damage: d8+1w/d12+1w/d8+1m

Range: 6/20/60 meters

Hide: -

Clip/charge Size: 8 shots

Clip/charge Cost: \$100

Skill: Heavy Weapons-*direct fire*

The mass cannon is something of a white elephant. While it's a powerful, hard-hitting gun, other heavy weapons hit just as hard with better range characteristics. The weapon's designers hoped to follow up on the success of its smaller cousins by designing a true man-portable antivehicular mass weapon, but they weren't able to achieve the kind of armor penetration increase they had hoped for.



2809_1501_37



LASER WEAPONS

The earliest energy weapons to appear, lasers have been adopted as the weapon of choice by many military organizations, including the Orion Planetary Defense Directorate and the Solar Army. What they lack in hitting power, they make up for with outstanding range and accuracy.

NINJA 600 LASER PISTOL

Koshimi Industries, Inc.
 Availability: Controlled
 Cost: \$1,225
 Mass/Length: 0.5 kg
 Length: 15 cm
 Payload: Coherent light
 Accuracy: -1
 Actions: 4
 Mode: F
 Type/Firepower: En/O
 Damage: d4+1w/d6+1w/d4m
 Range: 20/40/150 meters
 Hide: +4
 Clip/charge Size: 20 shots
 Clip/charge Cost: \$50
 Skill: Modern
 Ranged
 Weapons—pistol

The Ninja 600 is a small and easily concealable laser pistol built to the flush-front design. Like all lasers, it's extremely accurate and offers the best range characteristics of any handgun. The Ninja line is very popular with corporate execs and other affluent celebrities who want to carry a weapon for self-defense without advertising the fact that they're



armed. Most combat specs prefer a heavier weapon.

CLR-19 LASER RIFLE

A.M. Industries
 Availability: Military
 Cost: \$1,800
 Mass: 4 kg
 Length: 75 cm
 Payload: Coherent light
 Accuracy: -1
 Actions: 3
 Mode: F
 Type/Firepower: En/O
 Damage: d6+1w/d6+3w/d4+1m
 Range: 100/600/1500 meters
 Hide: -
 Clip/charge Size: 12 shots
 Clip/charge Cost: \$75
 Skill: Modern Ranged Weapons—rifle

The standard infantry firearm of the Orion League, the CLR-19 (Combat Laser Rifle-19) is a weapon of extraordinary range and accuracy. It's proven its value in numerous engagements against older charge weapons, especially in relatively open terrain. In close quarters, the weapon's length and low rate of fire are distinct drawbacks compared to the faster-firing and harder-hitting 11mm charge rifle.

VALKYRIE 9 AUTOLASER

Soze Arms, Ltd.
 Availability: Controlled
 Cost: \$1,725
 Mass: 3.25 kg
 Length: 35 cm
 Payload: Coherent light
 Accuracy: 0
 Actions: 4
 Mode: B/A

Type/Firepower: En/0

Damage: d6+1w/d6+3w/d4+1m

Range: 20/80/200 meters
Hide: -

Clip/charge Size: 10 bursts

Clip/charge Cost: \$75

Skill: Modern

Ranged Weapons—SMG



Valkyrie 9 Autolaser

The largest and most powerful autolaser available, the Valkyrie offers damage equal to a laser rifle with full automatic fire. While many people refer to the autolaser as a laser submachine gun, this is a misnomer—the device is not a machine gun and has little in common with any conventional firearm. Bursts or full-auto attacks with this weapon are actually sweeps and slashes of its white-hot beam.

STUTTER WEAPONS

Popular with police and riot troops, stutter weapons expel blasts of compressed air that can knock out subjects without causing serious injury. Used carelessly, stutter weapons can cause concussions, broken bones, or lung injuries, and there are a number of recorded instances in which people have died from accumulated stutter gun fire.

FALCON T9 STUTTER PISTOL

SekureTek Group

Availability: Common

Cost: \$375

Mass: 0.75 kg

Length: 20 cm

Payload: Compressed air

Accuracy: 0

Actions: 3

Mode: F

Type/Firepower: LI/0

Damage: d6+2s/d8+2s/d8+4s

Range: 4/8/20 meters

Hide: +4

Clip/charge Size: 10 shots

Clip/charge Cost: \$50

Skill: Modern

Ranged Weapons—*pistol*

One of the most popular handguns in human space, the Falcon T9 is syn-



onymous with reasonably priced, nonlethal personal defense. It's lighter and slimmer than the standard stutter pistol, trading range and clip capacity for easy concealment and use by people who aren't highly trained. "Point and say good-night" is the tag line for SekureTek's Falcon ads, and it's just about that easy.

CONDOR X7 STUTTER PISTOL

SekureTek Group

Availability: Common

Cost: \$850

Mass: 1.25 kg

Length: 25 cm

Payload: Compressed air

Accuracy: 0

Actions: 3

Mode: F

Type/Firepower: LI/0

Damage: d6+3s/d8+3s/d12+3s

Range: 8/16/40 meters

Hide: +1

Clip/charge Size: 8 shots

Clip/charge Cost: \$60



Skill: Modern Ranged Weapons—*pistol*

Professional peacekeepers prefer a more capable weapon than the light stutter pistols favored for personal defense. The Condor is an example of the heavy stutter pistol, a weapon designed for the subdual of armed, dangerous criminals. One hit almost always dazes or knocks out an unarmored opponent, and even armored targets can be brought down with accurate and sustained fire.

CYCLONE 700 STUTTER SMG

ThunderCorp Arms
 Availability: Controlled
 Cost: \$1,000
 Mass: 3 kg
 Length: 30 cm
 Payload: Compressed air
 Accuracy: 0
 Actions: 4
 Mode: B/A
 Type/Firepower: LI/O
 Damage: d6+2s/d8+2s/d8+4s
 Range: 10/20/80 meters
 Hide: +1
 Clip/charge Size: 20 bursts
 Clip/charge Cost: \$200
 Skill: Modern Ranged Weapons—SMG



The stutter SMG isn't a real submachine gun, of course; it's referred to as an SMG because of its high cyclic rate of fire. It's intended for use in close-quarters riot control or police raid situations in which the authorities must subdue a large number of people in a very short time. Stutter SMGs are also favored by special forces teams attempting to take prisoners instead of simply killing their enemies.

HEAVY STUTTER WEAPONS

Heavier stutter weapons are often used for game control on worlds where native lifeforms pose a threat to humans, for arming guards in high-security prisons or detention areas, and for crowd control under the most extreme conditions.

SIROCCO 100 STUTTER RIFLE

ThunderCorp Arms
 Availability: Controlled
 Cost: \$750
 Mass: 3.5 kg
 Length: 65 cm
 Payload: Compressed air
 Accuracy: -1
 Actions: 2
 Mode: F
 Type/Firepower: LI/O
 Damage: d6+3s/d8+3s/d12+3s
 Range: 20/40/200 meters
 Hide: -
 Clip/charge Size: 12 shots
 Clip/charge Cost: \$70
 Skill: Modern Ranged Weapons—rifle

In situations where you're only going to get one chance to stun an opponent, the stutter rifle's a good choice. It offers a longer range, more hitting power, and better accuracy than any other stutter weapon, making it perfect for taking out a problem with one clean shot at distance. The Sirocco is renowned as a scout's weapon, durable and effective; last year it won Merrick's Triple-Bullseye for best in class.



Roc ZI STUTTER CANNON

SekureTek Group
 Availability: Controlled
 Cost: \$2,500
 Mass: 15 kg
 Length: 110 cm
 Payload: Compressed air
 Accuracy: -1
 Actions: 2
 Mode: F
 Type/Firepower: LI/O
 Damage: $d6+2s/d8+3s/2d6+3s$
 Range: 20/40/80 meters
 Hide: -
 Clip/charge Size: 10 shots
 Clip/charge Cost: \$100
 Skill: Heavy Weapons—*direct fire*

When it's important to subdue a number of people in a hurry, the stutter cannon is the best tool for the job. The cannon affects all targets in a 3-meter radius, inflicting damage one category less than the damage inflicted to the primary target. For example, if the user scores a Good hit ($d8+3s$) against one rioter, all other people within 3 meters suffer Ordinary damage ($d6+2s$). Ordinary hits inflict no damage to nearby targets.

TAURI 9 IMPACT PISTOL

MRA Technologies, Inc.
 Availability: Controlled
 Cost: \$1,150
 Mass: 1 kg
 Length: 22.5 cm
 Payload: Compressed air
 Accuracy: 0
 Actions: 4
 Mode: F/B
 Type/Firepower: LI/O
 Damage: $2d4s/d6+1w/d6+3w$
 Range: 4/12/36 meters
 Hide: +2
 Clip/charge Size: 12 shots/4 bursts
 Clip/charge Cost: \$50
 Skill: Modern Ranged Weapons—*pistol*



A deadly refinement of stutter weapon technology, the impact pistol fires an even more powerful blast of compressed air that can powder concrete at close range. It can be set for a high-speed mode that allows burst fire (but not full automatic), or for low-speed, single-shot mode. Like any stutter weapon, the impact pistol doesn't work in vacuum due to the lack of air to compress.



BOWS, CROSSBOWS, AND DART GUNS

While any number of firearms or energy weapons provide better range, better damage potential, or higher rates of fire, modern versions of ancient weapons such as the bow or crossbow are still popular for special missions. Silent and deadly, an arrow or poison dart can kill just as easily as a bullet.

APACHE LX REFLEX BOW

StarMech Edge One Division
 Availability: Common
 Cost: \$650
 Mass: 1 kg
 Length: 135 cm
 Payload: Razor-tipped arrow
 Accuracy: 0
 Actions: 2
 Mode: F
 Type/Firepower: LI/O
 Damage: $d4+2w/d6+2w/d4+1m$
 Range: 50/100/250 meters
 Hide: -
 Clip/charge Size: 1 shot
 Clip/charge Cost: \$25
 Skill: Primitive
 Ranged Weapons—*bow*

The bow's greatest advantage is silence and stealth. It has no muzzle flash or loud report to give away the user's location, making it perfect for dense terrain such as jungle or heavy brush. Its disadvantage is the low rate of fire (after each "shot," the user must waste an action to ready another arrow, or shoot with a +2 step penalty) and its size, which prevents it from being fired from a prone position.





COMMANDO 3000 CROSSBOW

SekureTek Group
 Availability: Controlled
 Cost: \$950
 Mass: 2 kg
 Length: 75 cm
 Payload: Razor-tipped bolt
 Accuracy: 0
 Actions: 1
 Mode: F
 Type/Firepower: HI/O
 Damage: d6+1w/d8+1w/d6m
 Range: 60/120/300 meters
 Hide: —
 Clip/charge Size: 1 shot
 Clip/charge Cost: \$25
 Skill: Primitive Ranged Weapons—*bow*

Modern crossbows are extremely dangerous weapons, with hitting power comparable to a high-powered rifle. Like the bow, it's silent and dark, perfect for stealthy missions. On the downside, it's slow; after each shot, the marksman must spend an action to cock the weapon and ready another quarrel. However, crossbows can be carried cocked and can be fired from a prone position.

COBRA F77 DART GUN

SekureTek Group
 Availability: Common
 Cost: \$450
 Mass: 1.5 kg
 Length: 32.5 cm

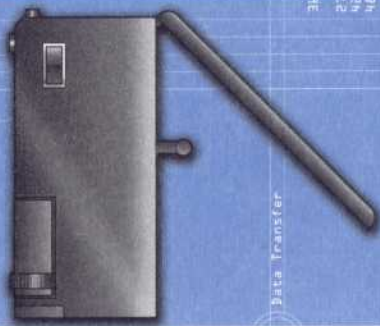

Payload: Poison-tipped dart
 Accuracy: 0
 Actions: 2
 Mode: F
 Type/Firepower: LI/O
 Damage: d4-1w/d4w/d4+1w
 Range: 4/8/16 meters
 Hide: +2
 Clip/charge Size: 6 shots
 Clip/charge Cost: \$100
 Skill: Modern Ranged Weapons—*pistol*

The dart gun is a pneumatic pistol designed to fire a large, hollow dart. One popular version of this gun (pictured) is a specially designed, pocket-sized weapon (Hide value +4, cost \$300). While the dart can inflict serious injury by itself, it's usually used as a delivery system for an insinuating venom. The typical dart is filled with neurotoxin (+1 step penalty to the victim's Constitution feat check, onset time d4 rounds) or a paralytic agent (+2 step penalty, onset time d4-1 rounds). See Chapter 3 in the *ALTERNITY Gamemaster Guide* for details on poison.

ARC GUNS AND FLAMERS

Designed for close assault, both arc guns and flammers are accurate weapons at short ranges. While the weapons don't have any real relation to each other, they're often employed in similar circumstances, which is why they're listed together in this series of entries.

BLUE BOLT ARC GUN

Dietterlich Industries
 Availability: Military
 Cost: \$2,750
 Mass: 10 kg
 Length: 85 cm
 Payload: Electrical arc
 Accuracy: -1
 Actions: 2
 Mode: F
 Type/Firepower: En/G



Blue Bolt Arc Gun

Damage: $d8+1s/d8w/d6+3w$
 Range: 20/40/100 meters
 Hide: —
 Clip/charge Size: 12 shots
 Clip/charge Cost: \$250
 Skill: Modern Ranged Weapons—*rifle*

The Blue Bolt has an unusual feature not found on many arc guns—a wireless taser setting. When it's activated, the gun's laser marker measures the target's surface resistance and calculates an appropriate stun charge. In taser mode, the Blue Bolt inflicts $d8+1s/2d6s/2d6+2s$ for an Ordinary, Good, or Amazing success on the attack skill check. Switching from taser mode to normal operation requires an action.

DEMON 9 HAND FLAMER

Soze Arms Ltd.
 Availability: Controlled
 Cost: \$1,200
 Mass: 4.5 kg
 Length: 40 cm
 Payload: Incendiary stream
 Accuracy: -1
 Actions: 3
 Mode: F/B/A
 Type/Firepower: En/0
 Damage: $d6w/d6+2w/d8+3w$



Range: 6/12/24
 Hide: -1
 Clip/charge Size: 10 shots/3 bursts
 Clip/charge Cost: \$100
 Skill: Modern Ranged Weapons—*SMG*

The Gravity Age successors to the venerable flamethrower, flammers are vicious weapons that spew a tight aerosol spray of self-oxidizing fuel gel at the target. Its broad pattern ensures great accuracy at close range, and the flame spray inflicts terrible wounds. By holding down the trigger and fanning the weapon from side to side, the user can achieve an autofirelike effect, but this rapidly exhausts his fuel.

DRAGON 3 HEAVY FLAMER

Soze Arms Ltd.
 Availability: Military
 Cost: \$2,400
 Mass: 8.5 kg
 Length: 65 cm
 Payload: Incendiary stream
 Accuracy: -1
 Actions: 2
 Mode: F/B/A
 Type/Firepower: En/G
 Damage: $d6+1w/d8+2w/2d6+1w$
 Range: 8/16/40 meters
 Hide: —
 Clip/charge Size: 15 shots/5 bursts
 Clip/charge Cost: \$200
 Skill: Heavy Weapons—*direct fire*

A larger and more powerful version of the hand flamer, the heavy flamer's fuel tank is worn as a backpack unit. Its high-volume, high-pressure discharge can ignite even the most flame-resistant objects and personal armor. While it doesn't have the range of many other heavy weapons, in close quarters there are few weapons that match the sheer terror and destructiveness of a heavy flamer.

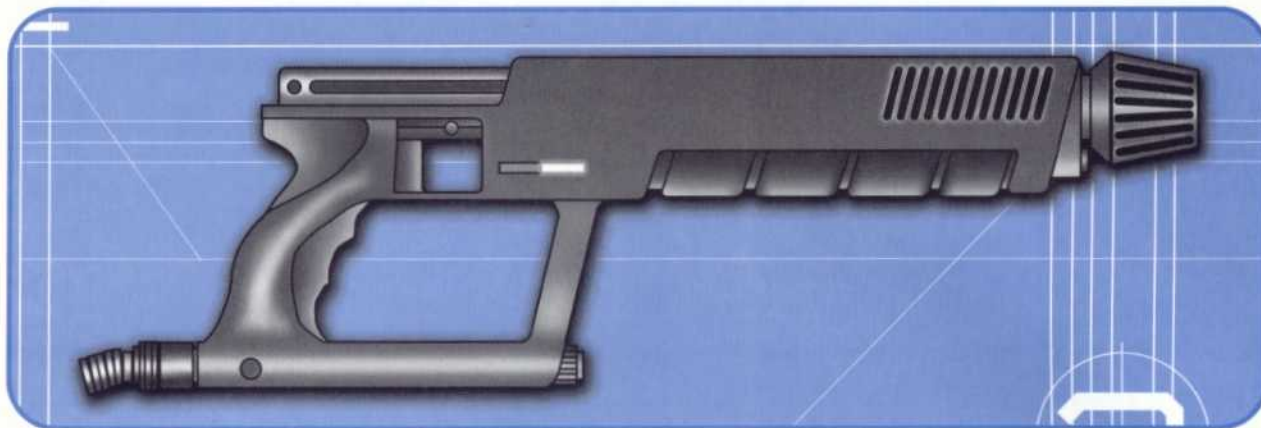

Dragon 3 Heavy Flamer

MISCELLANEOUS DIRECT FIRE WEAPONS

Dozens of various energy beams have been incorporated in experimental weapons—infrared lasers, gamma rays, heavy particle beams, and ultraviolet rays, to name a few. The weapons listed below illustrate a few of the more successful designs that are now found in military and civilian inventories throughout the Stellar Ring.

Z-LOK RENDER RIFLE

StarMech Edge One Division
 Availability: Restricted
 Cost: \$2,000
 Mass: 4 kg
 Length: 90 cm
 Payload: Graviton beam
 Accuracy: 0
 Actions: 3
 Mode: F
 Type/Firepower: En/0
 Damage: d6+1s/d6+1w/d4+1m
 Range: 50/100/250 meters
 Hide: —
 Clip/charge Size: 8 shots
 Clip/charge Cost: \$100
 Skill: Modern Ranged Weapons—*rifle*

The Z-LOK render rifle projects a graviton beam that creates destructive tidal attractions within the target's structure. While it's not particularly lethal compared to other Gravity Age rifles, it offers one big advantage—the target's armor is reduced to its minimal protection value against the beam. For example, cerametal armor normally stops d6 points of energy damage, but against a render rifle it only stops 1 point, the minimum possible (no roll allowed).

D16 PLASMA GUN

A.M. Industries, Orion League
 Availability: Military
 Cost: \$12,000
 Mass: 6 kg
 Length: 110 cm
 Payload: Incandescent plasma
 Accuracy: 0
 Actions: 2
 Mode: F
 Type/Firepower: En/G
 Damage: d8w/d8+2w/d8+4w
 Range: 50/100/400 meters
 Hide: —
 Clip/charge Size: 8 shots
 Clip/charge Cost: \$100
 Skill: Heavy Weapons—*direct fire*



Z-LOK Render Rifle



D16 Plasma Gun

The standard assault weapon of Orion League armored infantry, the D9 plasma gun is a spectacular weapon. Its massive energy discharge has a 2-meter area of effect. Anything in this area sustains damage one success grade lower than the damage inflicted to the point target, so if a plasma gun scores an Amazing hit, the target suffers d12+3w and anything else within 2 meters suffers a Good hit (d8+3w).

Also known as a particle gun or neutron gun, the quantum minigun produces beams of heavy, fast-moving subatomic particles that slag anything they hit. The minigun doesn't have the armor penetration capability of other heavy weapons, but its high rate of fire and high damage potential merit respect. The HAK-59 is currently in service in the Nariac Domain and with some VoidCorp troop formations.

HAK-59 QUANTUM MINIGUN

Karadnya-Brusilev Industries

Availability: Restricted

Cost: \$15,000

Mass: 10 kg

Length: 125 cm

Payload: Particle beam

Accuracy: 0

Actions: 4

Mode: F/B/A

Type/Firepower: En/O

Damage: d8+1w/d8+3w/d6m

Range: 40/80/200 meters

Hide: -

Clip/charge Size: 90 shots/30 bursts

Clip/charge Cost: \$300

Skill: Heavy Weapons—direct fire

ROCKET AND GRENADE LAUNCHERS

One of the most effective battlefield weapons for hundreds of years, portable artillery in the form of grenades or rockets is still popular in the Gravity Age. A rocket or grenade can take out large numbers of enemy troops with one blow. These launch systems make use of the various warheads described below.

ZK5 GRENADE LAUNCHER

Pulan-Tough Job Corporation

Availability: Military

Cost: \$1,500

Mass: 2 kg

Length: 55 cm

Payload: Various grenades

Accuracy: -1

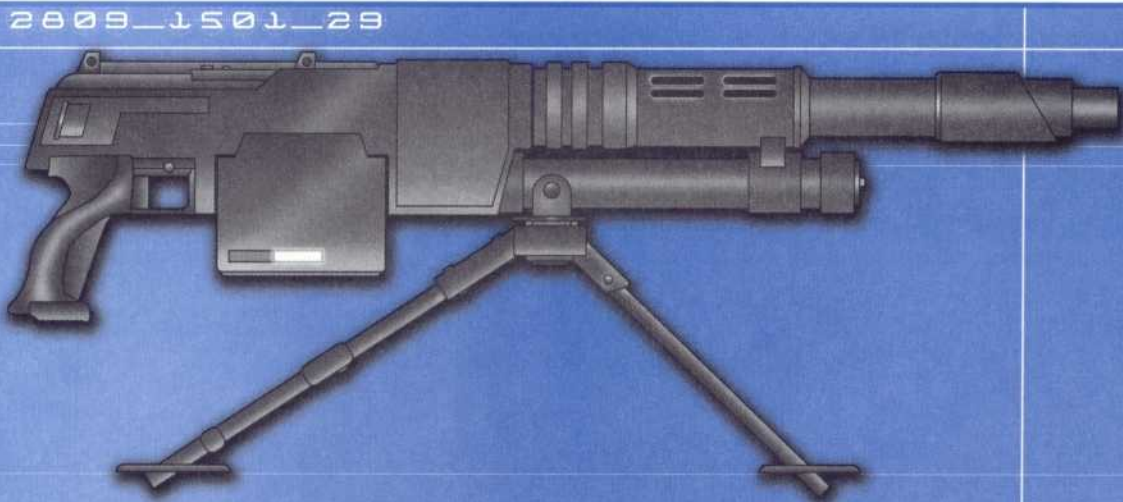

HAK-59 Quantum Minigun

Actions: 3
 Mode: F
 Type/Firepower: by warhead
 Damage: by warhead
 Range: 40/240/480 meters
 Hide: -2
 Clip/charge Size: 10 shots
 Clip/charge Cost: varies
 Skill: Heavy Weapons—*indirect fire*

The ZK5 (or "Zeke 5" as it's known by the Concord Marines) is a modern version of the old grenade launcher. Its drum-style magazine holds ten 30mm grenades, smaller but more powerful than their historical counterparts. The Zeke launches its fin-stabilized warheads by means of a low-powered linear accelerator, a simple sabot gun with much better range and accuracy than the old hand mortars.

BANTAM 5 ROCKET LAUNCHER

Soze Arms Ltd.
 Availability: Military
 Cost: \$4,000
 Mass: 7 kg
 Length: 80 cm
 Payload: Various rockets
 Accuracy: -2
 Actions: 2
 Mode: F
 Type/Firepower: by warhead
 Damage: by warhead
 Range: 40/400/2000 meters
 Hide: -
 Clip/charge Size: 4 shots
 Clip/charge Cost: varies
 Skill: Heavy Weapons—*indirect fire*

The Bantam 5 handheld rocket launcher is basically a hollow tube with laser-designating sights for the guidance of bantam rocket rounds. The rockets can be guided by the launcher's sights, or a remote observer can use a separate laser designator to mark targets out of the firer's line of sight, allowing attacks over hills or around corners.



The Soze Arms model of this popular weapon has a fifth launch tube for an extra shot.

BLOODHOUND F3 SMART GRENADE

SekureTek Group
 Availability: Military
 Cost: \$300
 Mass: 0.5 kg
 Length: 12 cm
 Payload: Various grenades
 Accuracy: -1
 Actions: 2
 Mode: F
 Type/Firepower: by warhead
 Damage: by warhead
 Range: per STR or 30/60/120 meters
 Hide: +3
 Clip/charge Size: n/a
 Clip/charge Cost: n/a
 Skill: Athletics—*throw*



The Bloodhound smart grenade is a delivery system attached to any other grenade warhead. The thrower can spend an action to lock its image targeting system onto a target. When he throws the grenade in a subsequent action, its rocket motor guides it to the target. In guided flight, the grenade has a range of 30/60/120 meters and an accuracy of -1; in unguided mode, it's treated like any other thrown grenade.



ROCKET AND GRENADE WARHEADS

Launchers are useless without ordnance to put on-target. Rockets can only be fired with a launcher, but grenades can be bought as dumb (listed cost, thrown weapon with a +1 accuracy), smart (cost +\$300, see details on previous page), or launch-ready (listed cost, see grenade launcher on previous page).

ANTI-AIR ROCKET

Availability/Cost: Restricted/\$1,000
 Mass/Length: 3 kg/65 cm
 Payload: Serrated rod warhead
 Type/Firepower: HI/G
 Damage: d4w/d4+2w/d4m
 Area of Effect: 4m/8m/12m

This bantam rocket features an IR guidance system and a fragmentation warhead to knock down enemy aircraft.

ANTI-PERSONNEL ROCKET

Availability/Cost: Military/\$500
 Mass/Length: 3 kg/65 cm
 Payload: Neutron radiation
 Type/Firepower: En/O
 Damage: d6w/d6+2w/d8+2w
 Area of Effect: 4m/8m/12m

Designed to knock out personnel without damaging vital equipment, the antipersonnel rocket delivers a deadly blast of neutron radiation on detonation. Like the anti-air rocket, it's an area-effect weapon.

ANTI-VEHICLE ROCKET

Availability/Cost: Military/\$1,000
 Mass/Length: 3 kg/55 cm
 Payload: Kinetic penetrator
 Type/Firepower: HI/G
 Damage: d4+2w/d4+4w/d4+1m
 Area of Effect: contact/2m/4m

This rocket delivers a discarding-sabot booster stage that can pierce very heavy armor. It's designed for use against light vehicles and heavy powered infantry.

CHE ROCKET

Availability/Cost: Military/\$250
 Mass/Length: 3 kg/65 cm
 Payload: Detonex warhead
 Type/Firepower: En/O or En/G
 Damage: d8-2w/d8w/d4m
 Area of Effect: 6m/10m/16m

This rocket is packed with a kilo of Detonex, one of the most powerful conventional explosives around. Its firepower is considered to be Good within 6 meters of the detonation point.

AP GRENADE

Availability/Cost: Military/\$400
 Mass/Length: 0.5 kg/15 cm
 Payload: Directional charge
 Type/Firepower: En/G
 Damage: d6-1w/d4m/d4+2m
 Area of Effect: contact/1m/2m

This grenade's radar fuse senses its orientation to the target and creates a shaped-charge blast on contact. It is designed for piercing vehicular and body armor.

CONCUSSION GRENADE

Availability/Cost: Military/\$150
 Mass/Length: 0.5 kg/15 cm
 Payload: Caseless explosive
 Type/Firepower: LI/O
 Damage: d6+3s/d6w/d6+2w
 Area of Effect: 2m/4m/6m

This grenade is a block of explosive in a nonfragmenting case. It's designed to incapacitate instead of kill.

FRAG GRENADE

Availability/Cost: Military/\$100
 Mass/Length: 0.5 kg/15 cm
 Payload: Shrapnel
 Type/Firepower: HI/G
 Damage: d8w/d8+1w/d4+1m
 Area of Effect: 2m/6m/10m

The fragmentation grenade is a very dangerous weapon, capable of hurling deadly shrapnel a great distance. Targets behind hard cover reduce the damage by one category, as if they'd hit the deck (see page 47 of the *ALTERNITY Gamemaster Guide*).

GAS GRENADE

Availability/Cost: Military/\$300
 Mass/Length: 0.5 kg/15 cm
 Payload: Poison gas
 Type/Firepower: LI/O
 Damage: d4s/d4+2s/d4w
 Area of Effect: contact/2m/4m

This weapon explodes in a cloud of poison gas 8 meters in diameter. This is a hemotoxin with an onset time of d4+1 rounds, and no modifier to the victim's Constitution feat check to resist its effects. See "Poison" in Chapter 3 of the *ALTERNITY Gamemaster Guide* for details.

PULSE GRENADE

Availability/Cost: Military/\$350
 Mass/Length: 0.5 kg/10 cm
 Payload: Electromagnetic pulse
 Type/Firepower: En/G
 Damage: d4+2s/d6+2s/d8+2s
 Area of Effect: 2m/4m/10m

The pulse grenade radiates a magnetic pulse on detonation, ionizing delicate electronics and interfering with

victims' nervous systems. Against electronics, cybernetic targets, or powered armor, it inflicts maximum damage (6 stuns for an Ordinary hit, etc.).

HOLSTERS AND SIGHTS

Thousands of weapon accessories are available to help a character carry, clean, conceal, or fire his weapon. These devices range from simple hip holsters to exotic holographic imaging sights, laser designators, and all kinds of high-tech hardware. Here are a few common choices:

FALCON X GUIDANCE SYSTEM

MRA Technologies Inc.

Availability: Military

Cost: \$1,250

Mass/Length: 0.1 kg/15 cm

Platform: Any projectile (type HI) weapon

This sighting system uses guided ammunition (see next

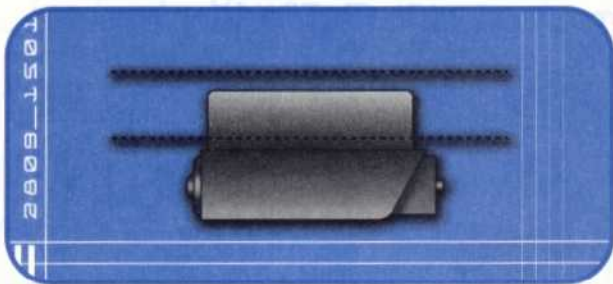

page). It consists of a low-powered laser target designator on the weapon's barrel. Firing the weapon takes two actions—one to set up the shot, and the following to make the attack skill check. When the weapon is fired, the guided ammo homes in on the laser signal with pinpoint accuracy, conferring a -3 step bonus to the attack skill check. Naturally, the guidance system can be turned off to allow fire in the normal unguided mode.

TARGET X HOLO SIGHTS

StarMech Edge One Division

Availability: Common

Cost: \$850

Mass/Length: 0.1 kg/10 cm

Platform: Any ranged weapon

The best long-range sights in production today, the Target X unit uses a sophisticated binocular apparatus to project a heads-up target image with a virtual crosshair. It works much like a telescopic sight, but with automatic rangefinding and no loss of peripheral



vision. Holo sights reduce any range penalties for long-range fire by two steps. Note that a weapon can only have one set of sights installed.

REAPER 700 IFF SIGHTS

AccuTron Optics Ltd.

Availability: Controlled

Cost: \$850

Mass/Length: 0.1 kg/10 cm

Platform: Any ranged weapon

IFF stands for Identify Friend or Foe, a system for preventing friendly casualties in combat. The user's allies must wear IFF transponders (a comm gear option costing \$50) keyed to the right frequency in order for the system to function. If an ally is standing in the line of fire, the IFF sight prevents the gun from firing. It's extremely useful in close-quarters assaults, since a gunman can hose down a crowded room without fear of hitting his friends—ignore the normal risks of firing into a melee if the gunman's allies are wearing transponders.

MONGOOSE IMAGING SIGHTS

NiteSite Manufacturing Inc.

Availability: Controlled

Cost: \$300

Mass/Length: 0.1 kg/15 cm

Platform: Any ranged weapon



This device is simply a light-intensifying scope mounted over the weapon's barrel. It reduces penalties for darkness by 2 steps, and penalties for long range by 1 step.

STEALTH HOLSTER

DarkTech Inc.

Availability: Controlled

Cost: \$400

Mass/Length: 1 kg/35 cm

Platform: Any pistol or SMG

The stealth holster is made with antiscan material and molded to the user's body contours. It adds +3 steps to a weapon's Hide modifier, making it much less likely to be detected. Because the holster is often hidden in a hard-to-

reach spot, the user suffers a +1 step penalty to his action check if he is attempting to draw his weapon in a hurry.

SPECIALTY AMMUNITION

Most weapon professionals prefer high-tech, high-quality ammunition over the basic rounds available for most firearms. The specialized munitions described below are available for any projectile weapon (any weapon that inflicts HI damage), including charge weapons, sabot weapons, and flechette weapons.

BLACK THUNDER AP ROUND

ThunderCorp Arms

Availability/Cost: Controlled/2× normal clip cost

Payload: Sabot penetrator

Platform: Any charge weapon

The Black Thunder bullet is a discarding-sabot Teflon penetrator designed to pierce armor. This high-impact round halves the effect of any armor it strikes (round up). For example, attack armor normally stops d6+1 points of HI damage. If the d6 result is a 4, the armor stops a total of 5 points of primary damage against standard ammunition, but it only stops 3 points of damage (one-half of 5, rounded up) from a Black Thunder round.

The damage roll of a sabot weapon using this round is reduced by 1 point, to a minimum of 1. Clips of AP ammo are twice as expensive as clips of normal ammo.

MIGHTYMITE EXPLOSIVE ROUND

Dietterlich Industries

Availability/Cost: Military/4× normal clip cost

Payload: Detonex warhead

Platform: Charge and sabot guns

Tipped with a Detonex-filled slug, the MightyMite explodes a split second after impact, causing ghastly wounds. If the bullet penetrates the target's armor (i.e., the target suffers primary wound or mortal damage from the attack), the exploding bullet inflicts d6-3 additional wound points that the victim's armor does not block.

ARCHER AA STABILIZED ROUND

TexMex Munitions Inc.

Availability/Cost: Controlled/3× normal clip cost

Payload: Fin-stabilized sabot

Platform: Charge and sabot guns

This round is not rifled for spin-stabilization as most conventional slugs are; instead, it resembles a small aerodynamic dart, deploying small fins after leaving the barrel. It's extremely accurate, reducing penalties for medium- and long-range fire by 1 step.

SHREDDER C5 FLECHETTE AMMO

Soze Arms Ltd.

Availability/Cost: Controlled/2× normal clip cost

Payload: Flechette bundle

Platform: Charge guns

This round converts a standard charge pistol or rifle into a flechette weapon. The weapon's range is reduced to 6/12/30 meters, and its damage to d4w/d6w/d4m—but its damage doubles for short-range shots. The Shredder C5 is popular for close-quarters fights, naturally; damage for long-range shots is reduced to one-half normal.

B-MACE GEL ROUND

StarMech Edge One Division

Availability/Cost: Controlled/2× normal clip cost

Payload: Soft gel capsule

Platform: Charge or sabot guns

Intended for nonlethal target subdual, the gel round converts any wound damage normally inflicted by the weapon to stun points, and any mortal damage to twice that number of stun points. The B-Mace suffers a +1 step penalty to long-range fire.

TALON X GUIDED ROUND

MRA Technologies Inc.

Availability/Cost: Military/5× normal clip cost

Payload: Laser-guided slug

Platform: Charge or sabot guns

The Talon X guided round is necessary in order to take advantage of the Falcon X weapon guidance system (see previous section). A Talon X round is fitted with a laser-seeking head and aerofoils for in-flight course correction. Without guided ammo, the guidance system is useless.

SNAKE EYES IR HOMING ROUND

TexMex Munitions Inc.

Availability/Cost: Military/4× normal clip cost

Payload: Infrared-guided slug

Platform: Charge or sabot guns

The infrared homing bullet is fitted with a tiny heat-seeking sensor in its head, adjusting its path to strike likely heat sources. It offers a -2 step bonus to medium-range attacks, or a -1 step bonus to long-range attacks.

If the attack skill check fails, the bullet locks on to some other likely heat source, and the user must then make a normal attack skill check against the alternate target. Sometimes this is another enemy nearby, but the Snake Eyes can't distinguish between friend and foe. (It's not a good round to fire into a area where friendlies are mixed up with hostiles.) If the second attack misses, too, the bullet doesn't endanger anyone else.

ASSAULT GEAR

Offering a good mix of light mass and full-body protection, assault gear is a more resilient variety of riot gear designed to stand up to light small arms fire. Heavy carbonate fiber panels are sewn into the torso, hips, thighs, and upper arms for additional reinforcement. Since this type of armor provides full-body coverage, it's often used with a respirator or a gas mask. Assault gear is favored by security forces, counterinsurgency details, and paramilitary organizations.

BATTLEHAWK ZERO-G ASSAULT GEAR

SekureTek Group Ltd.

Availability: Controlled

Cost: \$3,250

Mass: 8 kg

Composition: CF weave

Environmental Tolerance:

Gravity: n/a

Radiation: R0-R3 protected

Atmosphere: A0-A3 protected

Pressure: P0-P3 protected

Heat: H1-H3 protected

Action Penalty: +2

Toughness: Ordinary

LI/HI/En: d6-1/d6/d6-1

Hide: -

Effective Strength: n/a

Skill: Armor Operation-*combat armor*

Battlehawk assault gear is designed especially for use in low-gravity situations. Like the standard ship's jumpsuit, it seals against vacuum and includes a vacuum mask with an 8-hour supply of oxygen. A zero-g web with hip and boot thrusters is built into the armor, allowing omnidirectional free movement at a rate of up to 30 meters per phase. The stabilizing effect of the armor reduces penalties for zero-g activities by 1 step.

SCOUT 230 AET ASSAULT GEAR

Brusilev Armor Manufacturing

Availability: Military

Cost: \$4,400

Mass: 12 kg

Composition: CF weave

Environmental Tolerance:

Gravity: n/a

Radiation: R0-R3 protected

Atmosphere: A0-A4 protected

Pressure: P0-P3 protected

Heat: H0-H4 protected

Action Penalty: +2

Toughness: Ordinary

LI/HI/En: d6/d8/d6-1

Hide: -

Effective Strength: n/a

Skill: Armor Operation-*combat armor*

The acronym AET stands for All Environments and Terrains. The Scout 230 is basically an armored version of a soft e-suit. It can withstand most climatic extremes, although its soft construction makes it unsuitable for very high gravity or atmospheric pressure. Designed for long-term use in dangerous environments, the Scout 230 is exceptionally comfortable and can be worn for up to 120 hours straight before its onboard recyclers and oxygen supplies become exhausted.



Scout 230 AET Assault Gear

BALLISTIC ARMOR

Also known as battle armor, ballistic armor is descended from the bulletproof vests of the 20th century. It consists of light ceramic or cerametal plates sandwiched in a weave of carbonate fiber. These body armors offer better protection than CF alone, but battle vests and jackets cover a smaller area than assault gear or CF garments. Ballistic armor is common for police and light security details, as well as private citizens seeking a socially acceptable armor heavier than a CF coat.

BODYGUARD BALLISTIC VEST

Olsen Personal Defense Corp.

Availability: Common

Cost: \$750

Mass: 3 kg

Composition: CF/cerametal

Environmental Tolerance:

Gravity: n/a

Radiation: n/a

Atmosphere: n/a

Pressure: n/a

Heat: n/a

Action Penalty: 0

Toughness: Ordinary

LI/HI/En: d6-1/d6/d6-2

Hide: +3

Effective Strength: n/a

Skill: -

The BodyGuard vest is one of the most popular personal armors available. It's significantly lighter and more durable than its predecessors, capable of stopping an 11mm charge rifle round at point-blank range. It's only 18mm thick at its heaviest, and fits snugly under most street clothes without any outward sign (although security services typically wear the ballistic vest over their uniforms to deter armed resistance). The only drawback is the limited coverage of the vest—it offers no protection to the wearer's head or limbs.

LANDSKNECHT 34 BALLISTIC JACKET

Dietterlich Industries

Availability: Controlled

Cost: \$1,650

Mass: 6 kg

Composition: CF/cerametal

Environmental Tolerance:

Gravity: n/a

Radiation: n/a

Atmosphere: A0-A3 protected

Pressure: P0-P3 protected

Heat: H1-H3 protected

Action Penalty: +1

Toughness: Ordinary

LI/HI/En: d6-1/d4+1/d4-1

Hide: +1

Effective Strength: n/a

Skill: Armor Operation

Heavier and more extensive than the ballistic vest, a battle jacket like the Landsknecht provides an excellent compromise between mass, cost, and protective value. It can be awkward for people who aren't used to wearing body armor, but with minimal training anyone can get used to it. The Landsknecht is about the heaviest armor that could be worn in a rough-and-tumble spaceport without inviting unwelcome attention.

The ballistic jacket includes a hood with a face seal and a vacuum mask for emergency operations in zero-atmosphere situations, although it's not intended for open space.

CARBONATE FIBER (CF) BODY ARMOR

Carbon molecules are unique in their ability to form chains with virtually any physical properties desired. Carbonate fiber is an advanced armor weave in which nanoengineered polymers are used to create dense layers of bulletproof cloth. Light and easy to conceal, CF armor has become the personal protection of choice for people who prefer armor that doesn't advertise the wearer's defenses. Few organizations issue CF armor, but some light-duty security forces (shipboard security teams, technical experts, etc.) wear it.

HARAMAKI 100/200 CF COAT

Koshimi Industries

Availability: Common

Cost: \$800 (\$500 short)

Mass: 3 kg (2 kg short)

Composition: CF weave

Environmental Tolerance:

Gravity: n/a

Radiation: n/a

Atmosphere: n/a

Pressure: n/a

Heat: n/a

Action Penalty: 0

Toughness: Ordinary

LI/HI/En (long): d4/d4/d6-2

LI/HI/En (short): d4-1/d4-1/d6-3

Hide: +3

Effective Strength: n/a

Skill: -

Designed for comfortable wear all day long, the Haramaki series jackets come in two distinct styles—a heavy flight jacket (the short model), and a long overcoat or duster suitable for inclement weather (the long model). The long jacket is more expensive, but provides a modest increase in protective value since it covers a greater portion of the user's body. Neither jacket appears to be personal armor; they're noticeably heavier than street clothes of the same cut, but on the outside they seem to be typical garments.

MILANO GX CF BODYSUIT

New EuroTech Manufacturing

Availability: Controlled

Cost: \$2,250

Mass: 3 kg

Composition: CF weave

Environmental Tolerance:

Gravity: n/a

Radiation: n/a

Atmosphere: n/a

Pressure: n/a

Heat: n/a

Action Penalty: 0

Toughness: Ordinary

LI/HI/En: d8-1/d8-1/d6

Hide: +2

Effective Strength: n/a

Skill: —

The CF bodysuit is a heavier version of the popular soft-suit, with molded panels and a stylish appearance. Unlike the softsuit, it's meant to be worn in place of the user's clothes instead of under them; it looks like a tight-fitting jumpsuit. Some bodysuits are molded or patterned as exotic costumes or fighting outfits. The Milano is the top of the line in this type of armor, a garment of outstanding durability, comfort, and protective value. It can be vacuum-sealed, although it does not include a vacuum mask. While it's not intended for wear under clothes, it's light enough to be worn under clothes if the user wishes.

POLYMERE ATTACK ARMOR

Another advanced plastic, polymere is extruded as a very tough carbon fiber and then pressed into stiff plates. It's somewhat dated in today's culture, but many second-rate powers or organizations equip their forces with polymere plate armor. It's available in both powered and nonpowered versions; the powered version provides the wearer with an effective Strength of 15 for purposes of lifting, carrying, or breaking objects. This doesn't affect the wearer's skill scores or movement rates, but it does figure into his hand-to-hand damage adjustment.

DAUNTLESS 29 ATTACK ARMOR

Dieterlich Industries

Availability: Controlled

Cost: \$3,300

Mass: 12 kg

Composition: Polymere plate

Environmental Tolerance:

Gravity: n/a

Radiation: n/a

Atmosphere: A2-A3

Pressure: P1-P3

Heat: H1-H3

Action Penalty: +2

Toughness: Ordinary

LI/HI/En: d4+2/d6+2/d6



Dauntless 29 Attack Armor

Hide: –
 Effective Strength: n/a
 Skill: Armor Operation—*combat armor*

The Dauntless 29 is the last version of nonpowered polymere plate in production; most other manufacturers have switched to the cheaper and more robust cerametal armors. As the last refinement of this armor type, it's an outstanding design, lighter and tougher than any of its predecessors. Its helmet includes a respirator mask that can stand up to nonterrestrial environments and a built-in comm gear system, and two trauma packs (model I) are carried in thigh pockets. The Dauntless is available in a number of camouflage schemes (see battle dress uniform, page 13, for details).

TIGER MOD 6 POWERED ARMOR

Raupp Arms, Thulda Prime
 Availability: Military
 Cost: #9,000
 Mass: 25 kg
 Composition: Polymere plate
 Environmental Tolerance:
 Gravity: G2–G3
 Radiation: n/a
 Atmosphere: A2–A3
 Pressure: P1–P3
 Heat: H1–H3
 Action Penalty: +2
 Toughness: Good
 LI/HI/En: d6+1/d6+2/d6
 Hide: –
 Effective Strength: 15
 Skill: Armor Operation—*powered armor*

Forty years ago, the last Tiger suit rolled off the assembly line. Once standard equipment of the Thuldan Heavy Infantry, millions of units have been salvaged, modified, and refitted throughout the galaxy. The armor's integrated optics reduce penalties for long-range fire and poor lighting by 1 step each; its comm suite includes standard comm gear and a signal laser; and two trauma packs (model I) are carried on board. To help the wearer manage its systems, the Tiger contains a microcomputer of Marginal quality (see page 40); the armor operation utility program requires 1 slot of the computer's active memory.

CERAMETAL ARMOR

The best nonpowered armor available, cerametal consists of flexible, overlapping bands of ceramometallic (or cerametal, for short) plate. This advanced composite is lighter than the earlier polymeres, but offers significantly better protection against energy weapons—the ceramics used in this composite material can withstand incredible temperatures and dissipate heat very well. Cerametal provides the best protection short of a powered suit, and many military forces prefer cerametal since it doesn't require the technical support of a powered armor.

ACN 4 CERAMETAL ARMOR

Austrin-Ontis Armor Division
 Availability: Military
 Cost: #2,000
 Mass: 10 kg
 Composition: Cerametal bands
 Environmental Tolerance:
 Gravity: n/a
 Radiation: n/a
 Atmosphere: A2–A3
 Pressure: P1–P3
 Heat: H1–H3
 Action Penalty: +2
 Toughness: Ordinary
 LI/HI/En: d6+1/d8+1/d6
 Hide: –
 Effective Strength: n/a
 Skill: Armor Operation—*combat armor*

The ACN-4 (Armor, Cerametal, Nonpowered) has been adopted as the standard armor for the Concord Marines' famous Recon/Marauder teams. These soldiers are expected to face heavy planetside action with little supply and support for months at a time; therefore, the ACN-4 is designed as a low-maintenance, low-mass nonpowered armor. The ACN-4 can be packed into a compact bundle for carrying with the rest of a soldier's field kit, making it easy to take on long overland marches. It takes about 5 minutes to unpack and don the armor from its compact stowage.

BUSHMASTER CERAMETAL MAIL

MRA Technologies, Inc.
 Availability: Controlled
 Cost: #2,650
 Mass: 7 kg
 Composition: Cerametal links
 Environmental Tolerance:
 Gravity: n/a
 Radiation: n/a
 Atmosphere: n/a

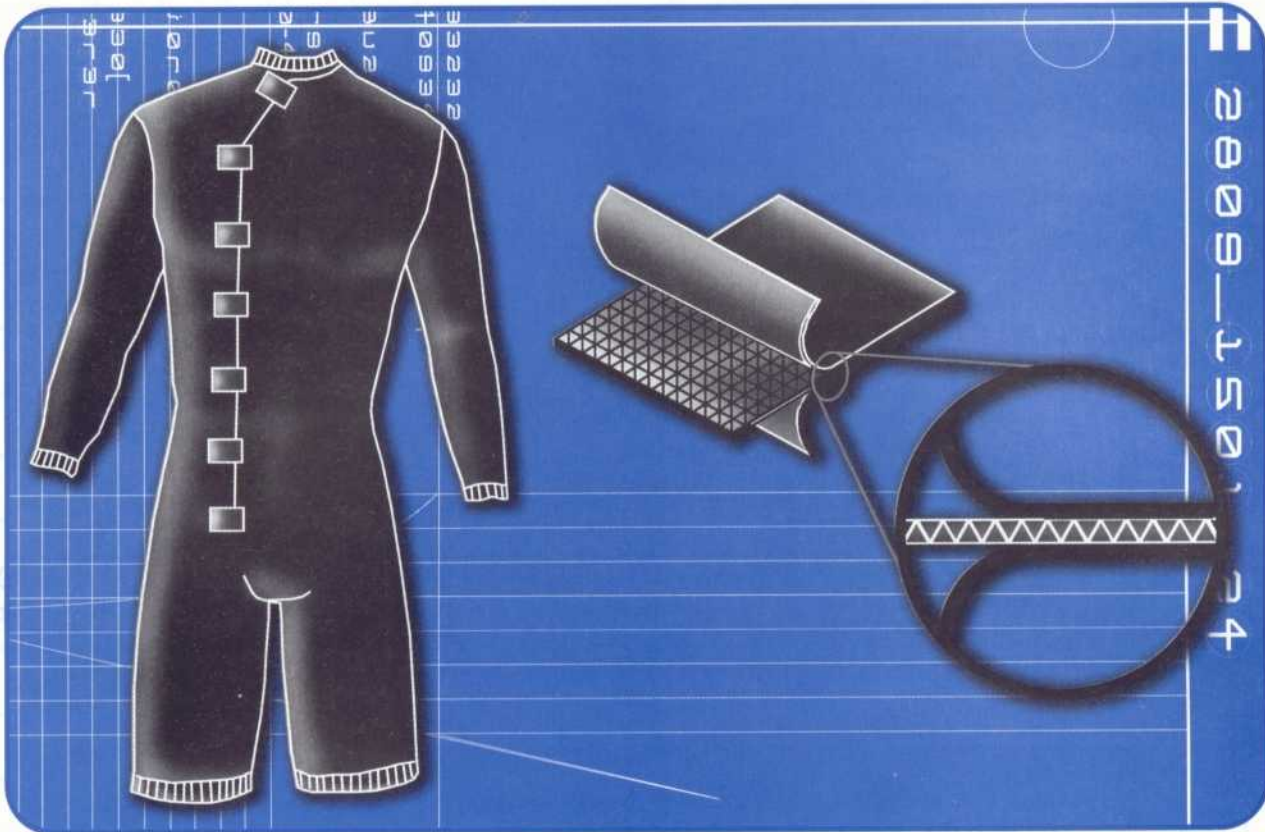

Bushmaster Cerametal Mail

Pressure: n/a

Heat: n/a

Action Penalty: +1

Toughness: Ordinary

LI/HI/En: d4+2/d6/d6

Hide: +1

Effective Strength: n/a

Skill: Armor Operation

The Bushmaster is a tight-fitting garment of extremely fine cerametal chain mail. It covers the wearer from the neck to the knee, and is surrounded by layers of carbonate fiber weave. Designed for use on worlds with dangerous lifeforms, it's especially resistant to cutting, slashing, and tearing-type attacks. It's tougher than any lighter armor, and lighter than any tougher type of armor, offering a good compromise of flexibility, light mass, and protection. A strong swimmer can easily manage the Bushmaster's mass, and the vented padding quickly airs out after an immersion in water.

NEUTRONITE MAIN BATTLE ARMOR, POWERED (BODY TANK)

Powered by a high-density array of lanthanide capacitors, the body tank is the heaviest personal armor available. It's composed of neutronite alloy, a superdense material

several times heavier than lead (fortunately, a little neutronite goes a long way). The armor's batteries can only power 12 hours of intense action, or 72 hours of intermittent activity, so main battle armor is typically reserved for intense shock assaults—maintaining a standing armored force in the field is very difficult.

ABM-5 PALADIN BATTLE ARMOR

General Arms Manufacturing

Availability: Restricted

Cost: \$25,000

Mass: 60 kg

Composition: Neutronite alloy

Environmental Tolerance:

Gravity: G1-G4

Radiation: R0-R4

Atmosphere: A0-A4

Pressure: P0-P4

Heat: H1-H3

Action Penalty: +4

Toughness: Good

LI/HI/En: 2d4+1/2d4+1/2d4

Hide: -

Effective Strength: 16

Skill: Armor Operation—*powered armor*

The Paladin is the standard powered armor suit of the Concord Marines and Planetary Defense Force. Its servo-

motors provide an effective Strength of 16 to the user for purposes of lifting, carrying, hand-to-hand damage adjustment, and breaking things. (The wearer's unmodified Strength is used for derived skill scores and resistance modifiers.) The Paladin's onboard systems are described in the accompanying box. In addition to the standard body tank systems, the Paladin's hydraulic motivators allow a movement of 20 meters per phase in broken terrain, or 40 meters per phase in open terrain, without fatiguing the wearer.

NEUTRONITE SPECIAL BATTLE ARMOR, POWERED (BODY TANK)

Special battle armor is even tougher than the basic neutronite body tanks. One popular model provides better protection while at the same time being easier to manipulate; another type is entirely devoted to keeping its wearer safe from damage, at the expense of being extremely unwieldy.

ABS-11 DRAGON RECON ARMOR

General Arms Manufacturing

Availability: Restricted

Cost: \$35,000

Mass: 50 kg

Composition: Neutronite alloy

Environmental Tolerance:

Gravity: G0-G4

Radiation: R0-R4

Atmosphere: A0-A4

Pressure: P0-P4

Heat: H0-H4

Action Penalty: +3

Toughness: Good

LI/HI/En: 2d4+2/2d4+2/2d4+1

Hide: -

Effective Strength: 15

Skill: Armor Operation—*powered armor*

Also known as a recon or scout body tank, the Dragoon is a lighter and more mobile powered suit. It has all the features described above, with one key addition—a gravity induction drive, providing flight capability at a maximum speed of 180 kph (or meters per phase). Since this is powered flight, the wearer suffers no fatigue damage for flying. On the ground, the Dragoon can move at 30 kph (or 30 meters per phase) in broken terrain, or 60 kph on open ground. Typically, one squad of troops in an armor platoon is equipped with recon armor.

BUILT-IN FEATURES

All modern powered armors include the following systems and features:

Targeting optics reduce penalties for long-range weapons fire by 1 step.

Image enhancement optics negate 1 step of penalties derived from darkness.

The onboard computer is considered to be a computer gauntlet of Ordinary quality (see page 42). It has no 3D slots, but does include a datastream link with a jack for direct connection and a comm link for data transmission.

The comm suite is a standard set of hands-free comm gear and a signal laser in the user's helmet. This signal device can also be used as a target designator for laser-guided ordnance.

A threat receiver detects radar and laser emissions impinging on the user, providing a -2 step bonus to Awareness checks to detect threats of this nature.

Trauma packs are installed to monitor the wearer's condition and preserve his life in case of injury; two type II trauma packs are included.

A smart display provides a topographical mapping system of the surrounding area, providing a -1 step bonus to Tactics checks.

The heavy weapon hardpoint allows the attachment of a heavy weapon system, usually a bantam rocket launcher with a magazine of four rockets. Other options include a 13mm heavy charge machine gun, a heavy flamer, or a 25mm sabot cannon.

AAS-23 TITAN ASSAULT ARMOR

General Arms Manufacturing

Availability: Restricted

Cost: \$50,000

Mass: 80 kg

Composition: Neutronite alloy

Environmental Tolerance:

Gravity: G0-G4

Radiation: R0-R4

Atmosphere: A0-A5

Pressure: P0-P5

Heat: H0-H4

Action Penalty: +5

Toughness: Good

LI/HI/En: 3d4/3d4/2d4+2

Hide: -

Effective Strength: 17

Skill: Armor Operation—*powered armor*

Fully space-to-ground capable, the Titan is also known as zero-g armor. It can be fitted with an ablative reentry

2809-1501-44

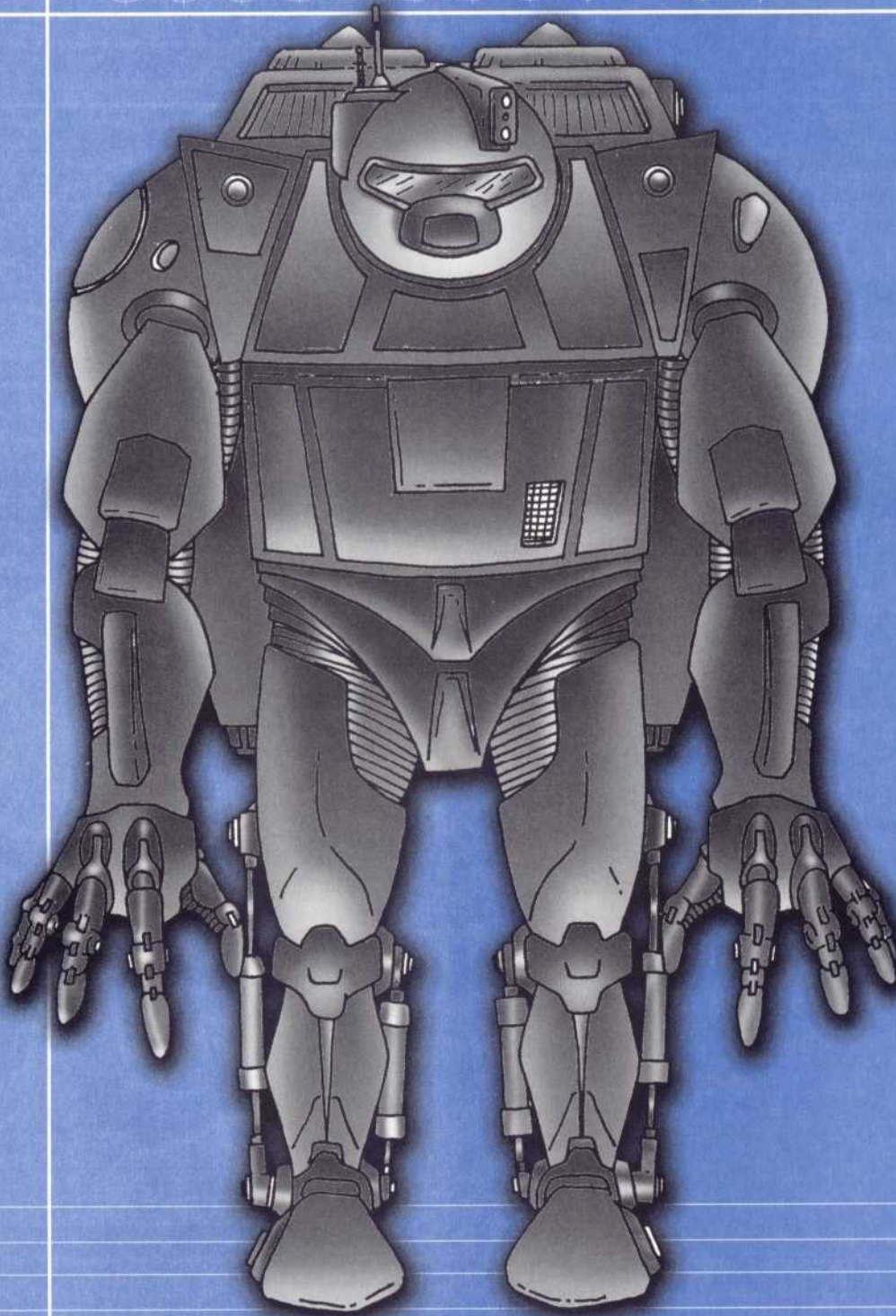

AAS-23 Titan Assault Armor

shroud (cost \$500) for orbital insertion, descending from an altitude of 200 km to the ground in about five minutes. It has limited flight capability and is rated up to an air-speed of 100 kph or ground speeds of 20 to 40 kph. The Titan features an air/space radar similar to the radar

gauntlet (see page 37), and its weapon hardpoint can be used to mount any of the following: a grenade launcher with a 12-round magazine, a bantam launcher, any direct-fire heavy weapon, or any powered melee weapon.

ASSAULT SHIELDS

For thousands of years, arm-carried shields have been one of the best ways to interpose an impervious barrier between an enemy's weapon and oneself. While shields can be very effective in some tactical situations, they have drawbacks—it's extra weight to carry, one of the user's hands is full, and they don't protect against rear or flank attacks. Against frontal attacks, however, the shield user may add the shield's benefit to his armor roll, increasing the amount of primary damage stopped.

AEGIS 650 CERAMETAL SHIELD

SekureTek Group Inc.

Availability: Common

Cost: \$225

Mass: 1.6 kg

Composition: Cerametal plate

Environmental Tolerance:

Gravity: n/a

Radiation: n/a

Atmosphere: n/a

Pressure: n/a

Heat: n/a

Action Penalty: +2

Toughness: Ordinary

LI/HI/En: +2/+2/+2

Hide: —

Effective Strength: n/a

Skill: Armor Operation—*combat armor*

The Aegis 650 is the kind of shield an ancient warrior would have treasured. Light and unbelievably strong, it can stop a 9mm round cold at point-blank range. The Aegis includes a vision slit of bulletproof polymere and a firing port, allowing the user to crouch behind it for portable hard cover. When used in this fashion, the Aegis provides a +1 increase to the user's resistance modifier against ranged attacks as well as providing its normal benefit of enhancing armor rolls. Naturally, the shield doesn't contribute to armor rolls against attacks from behind.

SAI POWERED SHIELD

StarMech Edge One Division

Availability: Controlled

Cost: \$6,500

Mass: 8 kg

Composition: Cerametal plate

Environmental Tolerance:

Gravity: n/a

Radiation: n/a

Atmosphere: n/a

Pressure: n/a

Heat: n/a

Action Penalty: +1

Toughness: Ordinary

LI/HI/En: +3/+2/+2

Hide: —

Effective Strength: n/a

Skill: Armor Operation—*powered armor*

The conventional shield's drawbacks are bulk and the problem of tying up the user's second hand. The SAI solves that; it's actually a free-floating unit powered by an induction motor. Its smart sensors detect incoming attacks and direct the shield to interpose itself automatically. The user of the SAI shield may even apply the shield's benefit against flank or rear attacks. However, there's a catch—the SAI automatically moves to parry the first attack that is directed at the user in any given phase of combat, hit or miss, and provides no benefit to subsequent attacks in the same phase that strike from a different quarter.

DEFLECTION SCREENS

With the advent of man-portable high-powered capacitors in the form of lanthanide cells, the first practical energy screens become possible. They're not impervious—controlling and shaping an energy field capable of deflecting or absorbing small arms fire takes up most of the unit's power, and even the best personal shields may not stop a powerful handgun. Heavy-duty versions of these screens are often featured in suits of powered armor, adding the benefits described below to the armor's innate protection.

RAMPART DEFLECTION INDUCER

MRA Technologies, Inc.

Availability: Controlled

Cost: \$1,350

Mass: 1.2 kg

Composition: Gravity field

Environmental Tolerance:

Gravity: n/a

Radiation: n/a

Atmosphere: n/a

Pressure: n/a

Heat: n/a

Action Penalty: 0

Toughness: Ordinary

LI/HI/En: +2/+2/+1

Hide: +4

Effective Strength: n/a

Skill: —

A cheaper version than the standard model, the Rampart sacrifices defensive power in exchange for light construc-

tion. The inducer creates a cylindrical field of gravitational energy surrounding the wearer at a range of 1 meter. Objects passing through this field in either direction are deflected from their course, inflicting a +2 step penalty to projectile or melee weapon attacks, and a +1 step penalty to energy attacks. The user suffers the same penalties to his own attacks. The inducer's cells can maintain the field for 5 rounds; turning the field on or off requires an action.

ANVIL 44 MAGNETIC SCREEN

Soze Arms Ltd.
Availability: Restricted
Cost: \$7,500
Mass: 3.5 kg
Composition: Magnetic force
Environmental Tolerance:
Gravity: n/a
Radiation: R0-R4
Atmosphere: n/a
Pressure: n/a
Heat: n/a

Action Penalty: 0
Toughness: Ordinary
LI/HI/En: +3/+3/+2 (Only effective against certain weapons; see descriptive text.)
Hide: 0
Effective Strength: n/a
Skill: -

The electromagnetic screen (or magnetic screen, for short) resembles the deflection inducer in operation, but protects the wearer with magnetic force. It provides excellent protection against metallic melee weapons, metallic rounds (charge, sabot, and flechette ammo), and weapons that fire electrical discharges, such as the arc gun. It provides no protection against other types of weapons or attacks. Since the screen is set to repel incoming attacks, it has no deleterious effect on the wearer's own attack rolls. Its energy cells last for 6 rounds of continuous use.

PARTICLE SCREENS

Energy screens rely on the use of electromagnetic or gravitational energy to deflect attacks. Particle screens work a little differently, by interposing a wall of subatomic matter contained within a magnetic field. Incoming attacks are scattered and absorbed by the particles, attenuating the attack. Particle screen technology is still new and unrefined; the machinery is heavy, expensive, and impractical. Typically, man-portable particle screens are limited to the heaviest powered armor. Note that no screen or field can be combined with any other.

ALPHA 50 PARTICLE SCREEN

MRA Technologies, Inc.
Availability: Military
Cost: \$8,500
Mass: 12 kg
Composition: Alpha particles
Environmental Tolerance:
Gravity: n/a
Radiation: R0-R4
Atmosphere: n/a
Pressure: n/a
Heat: n/a
Action Penalty: +1
Toughness: Ordinary
LI/HI/En: d6-3/d6-2/d8-2
Hide: -3
Effective Strength: n/a
Skill: Armor Operation—*powered armor*

The Alpha 50 generates a shell of alpha particles—helium nuclei stripped of their electrons. When a character wearing a particle screen is struck by a weapon, he may add the screen's protective value to the protection of his armor. For example, a hero wearing Paladin Body Armor and a particle screen actually stops 2d4+2 (for the armor), plus an additional d8-2, versus energy attacks. The screen "blinks out" when a hero fires his own weapon, so it automatically has no effect in any phase in which a hero attacks. It has a maximum endurance of 10 rounds before it shuts down.

SCM-16 CAPACITOR SCREEN

Austrin-Ontis Munitions Div 1
Availability: Restricted
Cost: \$15,750
Mass: 8.5 kg
Composition: Ionized air
Environmental Tolerance:
Gravity: n/a
Radiation: R0-R4
Atmosphere: n/a
Pressure: n/a
Heat: n/a
Action Penalty: +1
Toughness: Good vs. LI and HI, Amazing vs. En
Low Impact: +4s/2w/1m
High Impact: +4s/2w/1m
Energy: +6s/4w/2m
Hide: -2
Effective Strength: n/a
Skill: Armor Operation—*powered armor*

The Scam-16, as it's commonly known, creates a field of ionized particles from the air molecules in the user's

vicinity. Against low impact and high impact attacks, the capacitor screen is considered to have a toughness of Good; against energy attacks, its toughness is Amazing. In addition, the screen automatically reduces the damage of an attack by the amount listed, so an energy attack that inflicts 6 wounds is reduced by 4 to 2 wounds before secondary damage or the user's armor is taken into account. The screen can absorb d6+1 attacks before its capacitors are full and it's forced to shut down for at least 2 hours.

ALIEN ARMORS

Humans aren't the only species that manufactures armor. All of the aliens encountered to date have possessed some level of personal armor technology. The t'sa favor partial-plate armors that reinforce their natural armor by providing another layer of protection over vital areas; the fraal produce several advanced weaves that can be worn as everyday garments but are tougher than CF weave. The aboriginal sesheyans often wear light natural leathers (see ayaishe and beishen, pages 14–15).

KHE! BURUND (WEREN MAIL)

DhuhQeshQhe Maarhak

Availability: Controlled

Cost: \$3,500

Mass: 12 kg

Composition: Laminated steel

Environmental Tolerance:

Gravity: n/a

Radiation: n/a

Atmosphere: n/a

Pressure: n/a

Heat: n/a

Action Penalty: +1

Toughness: Ordinary

LI/HI/En: d6/d6–2/d6–2

Hide: –2

Effective Strength: n/a

Skill: Armor Operation—*combat armor*

Developed within the last hundred years to resist musket balls, the khe! burund is a hauberk of light chain mail with stiff leather strips woven between the links, worn over a leather arming coat. The coat covers the wearer's arms to the elbow, his legs to the knee, and includes a hood. Favored by many weren mercenaries and expatriates because it's an element of weren technology that stands up to human weapons, the khe! burund (the exclamation mark signifies that the first word is vocalized as a cough) has become an emblem of weren tradition in the face of overwhelming change.

PTOKH K'SE (T'SA)

Aakhi Bros. Goods & Trade

Availability: Common

Cost: \$800

Mass: 2 kg

Composition: Metal fiber

Environmental Tolerance:

Gravity: n/a

Radiation: n/a

Atmosphere: n/a

Pressure: n/a

Heat: n/a

Action Penalty: 0

Toughness: Ordinary

LI/HI/En: d6+1/d6/d6–1

Hide: +2

Effective Strength: n/a

Skill: –

The ptokh k'se (pronounced TAHKK-see, more or less) is the t'sa version of a bulletproof vest. It consists of a dense weave of extruded alloy wire, woven into a heavy cloth and sandwiched between tough artificial weaves. When

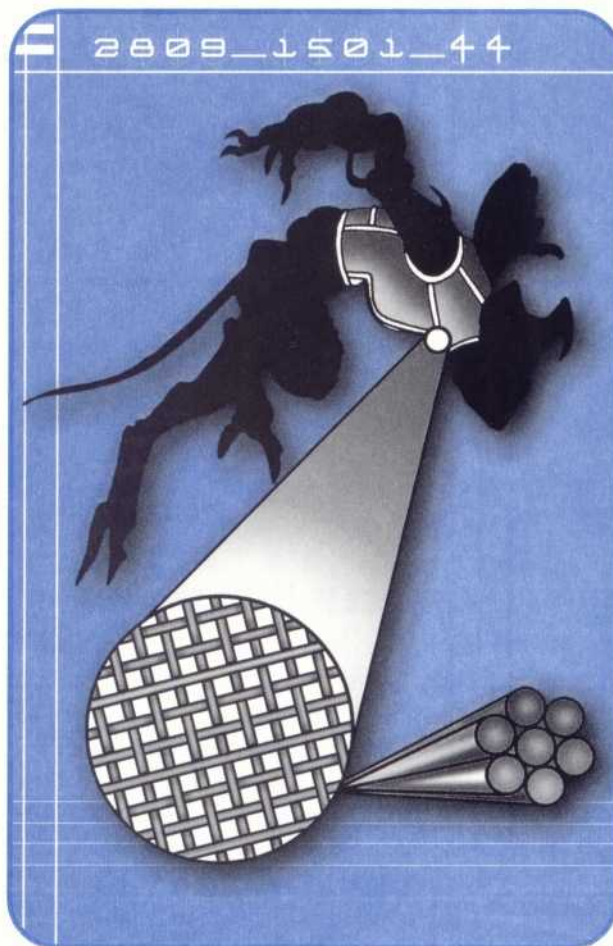

Ptokh k'se (t'sa armor), showing magnified view of extruded alloy weave

worn, the ptokh k'se improves the t'sa's natural armor value from d4+1 (LI), d4 (HI), d4-1 (En) to the values given in the statistics. (This is an exception to the rule about layering armor; see Chapter 11 of the *ALTERNITY Player's Handbook*.) While its mass is noticeable, the vest is thin and flexible enough to be worn under almost any other garment. Few t'sa like to wear heavy battle armor, but the ptokh k'se is a good compromise between ease of movement and protection.

BELLWEYN SIL (FRAAL)

Innishaal Space Industries
Availability: Controlled
Cost: *6,500
Mass: 2 kg
Composition: Molecule weave
Environmental Tolerance:
Gravity: n/a
Radiation: n/a
Atmosphere: n/a
Pressure: n/a
Heat: H1-H3
Action Penalty: 0
Toughness: Ordinary
LI/HI/En: d6/d6-1/d6-1
Hide: -
Effective Strength: n/a
Skill: -

The bellweyn sil ("battle-coat" in the fraal tongue) is a protective garment that embodies some of the elegance and aesthetics of the species. It consists of a light arming

ADAPTING "HUMAN" ARMOR

In addition to the four types presented on these two pages (and variations on these basic themes), aliens are also capable of wearing some of the kinds of armor described earlier in this section. In particular, fraal and mechalus, because of the close similarity of their body shapes to the human form, have relatively little trouble locating human armor that they can wear. For example, a fraal who normally wears a bellweyn sil but sometimes finds herself in situations where she needs extra protection beyond what that armor provides might also own a CF bodysuit (page 71).

The sesheyen, weren, and t'sa are at somewhat of a disadvantage when it comes to fitting into armor designed primarily for humans. Some vests and jackets can be altered to fit a nonhuman body, but bulkier and stronger types of armor are not as easily modified. (See "Aliens in Armor" in Chapter 11 of the *ALTERNITY Player's Handbook* for some general guidelines.)

suit of engineered molecular weave. Over this layers of stiffened molecular weave are fashioned into soft, overlapping bands that vaguely resemble ancient human armors. Richly adorned with embroidery and metallic finishes, the bellweyn sil is a spectacular garment suitable for many diplomatic or formal affairs. Fraal leaders, guards, and emissaries often wear this garment when dealing with less developed species.

HAD'NILTAS (MECHALUS)

Nori Cho' Manufacturing
Availability: Restricted
Cost: *25,000
Mass: 12 kg
Composition: Nanofluidics
Environmental Tolerance:
Gravity: G0-G4
Radiation: R0-R4
Atmosphere: A0-A4
Pressure: P0-P4
Heat: H0-H4
Action Penalty: +1
Toughness: Ordinary
LI/HI/En: 2d4/d6+1/2d4+1
Hide: +1
Effective Strength: 15
Skill: Armor Operation—*powered armor*

An outstanding example of alien technology, the mechalus had'niltas is a superior suit of powered armor. Unlike the bulky plated suits developed by human armorers, the had'niltas is light and flexible. It consists of a full-body jumpsuit or wrap of advanced fabric. Inside the suit's fabric is a layer of liquid metal containing millions of nanocircuits. These instantly respond to any attack, hardening the suit at the point of impact and dissipating heat or energy. The had'niltas is nearly impervious to slashing attacks or energy weapons, but high-velocity projectiles can sometimes penetrate before the suit reacts.

ADVANCED TECHNOLOGY

The khe! burund and ptokh k'se represent fairly simple designs familiar to human armorers, but other aliens have created extremely sophisticated armors unlike anything crafted by humankind. The fraal possess a materials technology that is still ahead of human technology in many regards, despite centuries of close partnership between the species.

Similarly, the mechalus demonstrate a superior command of nanotechnology. The had'niltas is a garment that binds with mechalus biocircuitry, echoing the wearer's motions at the speed of thought.

THE EDGETECH OUTFITTER'S CATALOG

Unlike the other catalogs and sources listed in this book, the EdgeTech Outfitter's Catalog is a publication native to the Verge. Specializing in exploration, excursion, and colonization equipment and supplies, EdgeTech is a small but profitable company with an excellent reputation for high-quality goods, realistically designed with local conditions in mind.

There's a lot of interesting (some might even say sordid) history behind EdgeTech. The company is a minor holding of the powerful Calefir family of Alaundril. Like many of Alaundril's merchant-nobles, the Calefirs were among the first settlers of the Tendril system, and therefore some of the first human settlers in the entire Verge. These first colonists were followed by wave after wave of immigrants as news of the exploration of the Verge trickled back to Old Space, precipitating an old-fashioned land rush.

The Calefirs of the day opened business after business catering to the river of colonists and prospectors streaming into the Verge. Bars, boarding houses, red-light establishments, and outfitting companies boomed as business,

CAMPAIGN TIPS

The Calefir mercantile empire is representative of the Verge's political situation today; it's a powerful local force endangered by the return of colossi such as VoidCorp, the Rignumors, StarMech, and other interstellar megacorps. For almost one hundred years, the Calefirs have had everything their own way—now they're facing the specter of competition, assimilation, or outright destruction. They've gone from being a big fish in a little pond to being a little fish in a very big pond, and they don't like it at all.

Already the interstellar megacorps are beginning to sink their roots into Alaundril's proud oligarchy. The Baoli family, one of the old rivals of the Calefirs, have entered into a partnership with the Rignumor Star Consortium Merchant Exchange. More of the Calefirs' peers are considering similar deals. As the family resists the pressure to accommodate the Arrivers, there's going to be a lot of money on the line—and more direct forms of pressure may be applied to force the Calefirs to toe the line.

In the meantime, EdgeTech is the place to go for heroes who want to equip themselves for an expedition to an unknown system or planetary survey work. The Calefirs would like nothing better than to see their logos associated with prominent and commercially successful expeditions.

both legal and illicit, became the primary occupation of the original colonists of Alaundril.

Over several decades of boom-and-bust cycles, the Calefirs gradually lost their holdings in service industries while establishing a firm presence in the outfitting and provisioning business. When the Second Galactic War closed the Verge to Old Space immigrants, Alaundril suffered through a thirty-year depression of planetwide proportions . . . but the Calefirs managed to ride out the storm, and with the prospect of millions of new immigrants pouring into the Verge in the near future, they're doing everything they can to stake their claim to the coming bonanza.

EdgeTech's manufacturers are other companies in the Calefir family. Its vehicles are produced by Solar X Motors, a major skycar manufacturer—the jewel in the Calefir crown. The spacecraft described here are built in the orbital Solar X Shipyard, a marginal enterprise that the Calefirs operate simply because it allows them to maintain their own private space navy. EdgeTech itself manufactures a variety of basic camping and excursion equipment, and a small company called XTreme ActiveWear makes some of the more specialized gear in the EdgeTech catalog.

All in all, the EdgeTech and Solar X mercantile empire has carried the Calefirs to the forefront of Alaundril's oligarchy. Few other families possess their prestige, their wealth, or their power.

The EdgeTech Outfitter's Catalog is published as a single 3D crystal and distributed throughout the Verge on a quarterly basis. It's available in almost every sizable community or outpost.

ORDERING INFORMATION

The EdgeTech Retail Warehouse, in the city of Babel on Alaundril, is the best place to go to purchase the company's goods. Not only is every item in the catalog on display and available for testing or modeling, the prices on location are about 80% of the prices listed in the catalog.

If Alaundril is out of the way, customers can place an order by filling out a simple message blank order form included with the catalog disk and transmitting it as a datastream file. Interstellar orders require 2 to 4 weeks for delivery, with a surcharge of 10% for shipping and handling.

TERRA X CAMPING ACCESSORIES

You're an outdoorsman, an explorer, a trailblazer. You need the finest camping supplies in the Verge. There's a lot of dangerous and unknown territory out there—why risk your life with inferior equipment? Our Terra X collection is field-tested in a variety of conditions and certified 100% safe in any Class I or II environments.

TERRAINMASTER 5 PORTABLE CABIN

Availability: Any
Cost: \$1,175
Mass: 30 kg
Stock No.: 350CP2947

The best man-portable shelter in its class, the TerrainMaster stows in a convenient backpack frame. While it is a serious load for one hiker, the TerrainMaster's stowage frame includes a built-in mass neutralizer that reduces its mass to a mere 5 kilograms when activated! (The neutralizer has an endurance of 20 hours at this setting, or 50 hours if it's set to reduce to 15 kg. Remember to save some power for the hike back!)

When you reach your destination, simply drop the portable cabin in an appropriate spot and pull the inflation cord. Two CO₂ cartridges instantly fill the cabin's durable pneumatic structure with gas, creating a tough and sturdy shelter in the blink of an eye! Inside, you'll find a built-in camping unit and space for six sleeping bags in a spacious 4-meter-by-3.5-meter floor plan. The camping unit is a heater, stove, air conditioner, and cold storage unit in one compact package; it can heat or cool the cabin for up to 2 weeks, or 1 week in extreme temperatures (H1 to H3 conditions).

The cabin's inflation bladders are partitioned by one-way flap valves. It takes dozens of small punctures or several large rips or slashes to create a noticeable sag. The tough plastic has Ordinary toughness, 12/12/6 durability points, and the following armor characteristics: d6-1 (LI), d6-3 (HI), d6 (En).

STEVENS A20 CAMPING MODULE

Availability: Any
Cost: \$265
Mass: 8 kg
Stock No.: 340CM9076
Built around a high-tech heat exchanger and circulation system, the camping

module is a one-piece stove, heater, refrigerator, and air conditioner. One lantth cell provides up to 20 days of normal operation, or 10 days of operation in extreme temperatures and climates. The Stevens can hold up to 12 kg of supplies and rations in its cold-storage chamber (these aren't included in the listed mass of 8 kg). Lightweight, long endurance, compact stowage, and durability—you can expect the best from Stevens!

GLIESE 300 HABITAT DOME

Availability: Any
Cost: \$1,750
Mass: 50 kg
Stock No.: 390DH3677

It's standard gear in many escape pods, launches, and shuttlecraft—so why shouldn't you have one too? Our Gliese 300 habitat dome is made of microengineered numaplas—a tough, heavy plastic fabric chambered with self-inflating pneumatic bladders. A single standard CO₂ cartridge (two are included) can deploy the dome in moments. When inflated, the dome is 2 meters tall and 5 meters in diameter. The 300 model has a functional full-sized airlock door, and the entire dome can withstand zero-pressure (P0) to dense-pressure (P4) environments.

The Gliese 300 dome is designed for survival in intolerable environments. In addition to a camping unit capable of heating or cooling the dome for up to two weeks in any environment, the habitat dome also features an emergency beacon (see page 33), forty meals of rations, and a water purifier. The patented AirClear scrubber and circulation system includes two 8-kg oxygen tanks, each capable of providing 100 man-hours of air.

The habitat dome's sturdy walls have Ordinary toughness and armor protection equal to d6-1 (LI), d6-3 (HI), d6-1 (En). The dome has 14/14/7 durability points.

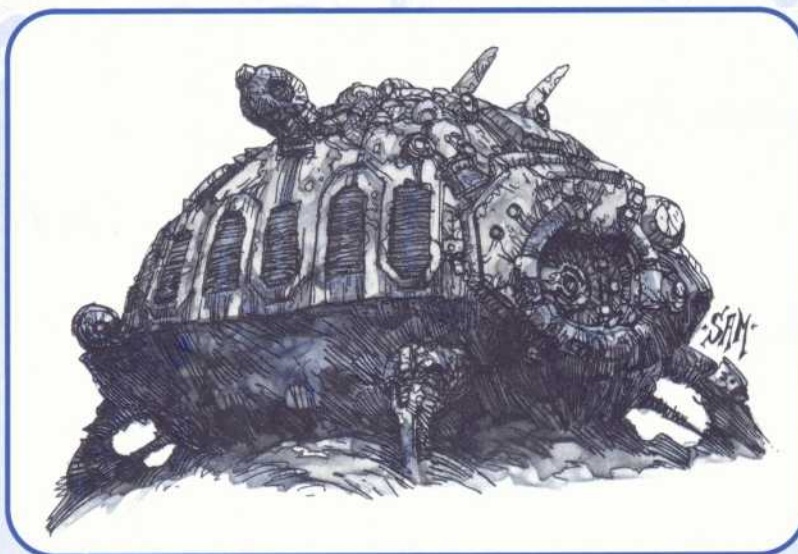

Gliese 300 Habitat Dome

NUTRIMIX RATION BARS

Availability: Any
 Cost: \$5
 Mass: 0.25 kg
 Stock No.: 300RN4546

Let's face it—hauling rations and water for a long overland expedition is no fun at all. Provisions are heavy, easily contaminated, and—worse yet—most taste like wet cardboard. But despair no longer—our NutriMix bars are the answer you've been looking for!

Each bar contains enough carbohydrates, protein, vitamin supplements, and water content to keep a 100-kilo man on his feet for a full day. And they're delicious, too! Specify your choice of flavor: Meaty Loaf, Beany-Rito, Tangy Bar-B-Q, or Wild Berry. **SPECIAL WARNING:** In extremely hot climates, we recommend supplementing the NutriMix bar with 1 to 5 liters of pure water per day to avoid dehydration.

BOLTHOLE CD SLEEPING BAG

Availability: Any
 Cost: \$225
 Mass: 0.5 kg
 Stock No.: 360CS0983

Anyone who's ever spent a night out in the wild can tell you that a top-notch sleeping bag is worth its weight in gold. The Bolthole CD has a built-in air mattress inflated by a handy foot-pedal pump and 100% TrailTech climate weave for sleeping comfort in temperatures ranging from -40° to 60° C (-40° to 140° F). Available in a variety of camouflage patterns, the Bolthole seals in your scent and thermal signature, virtually guaranteeing a night free of insects, carnivores, and other unpleasant local flora (+2 step penalty to any Investigate-track or Awareness-perception skill checks devoted to locating a character encased in the Bolthole).

ARBOREAL SLEEPING PLATFORM

Availability: Common
 Cost: \$2,375
 Mass: 20 kg
 Stock No.: 380PC2004

Do you need to be certain that nothing on the ground is going to interrupt your rest? That ground water, hillsides, and hungry predators won't bother you in the least? Give the ArboReal a try! Made from ultralightweight folding polymere plates, the sleeping platform unfolds from a backpack-sized unit to a flat, stable surface 3 meters in diameter. Beneath the platform is a powerful induction motor capable of lifting up to 1,000 kg to any altitude

desired at the rate of 10 meters per minute. Roost in the upper branches of the rain forest, anchor yourself safely to a sheer mountainside, or even ride out the night a kilometer in the sky!

The platform's lantn cells provide a total of 10,000 kilogram-hours of operation, so a load of 200 kg (two normal-sized humans with a good array of supplies and gear) could use the platform for 10 hours a day over the course of 5 days before exhausting the charge. The platform's cell power indicators provide plenty of warning before the platform gracefully sinks to the ground again.

Naturally, the platform includes a short safety rail, as well as a safety web to keep sleepers on the platform. Secured in the foliage of a tree or alongside a cliff, the ArboReal is very stable and provides decent cover against weather. In the open air, the ArboReal is uncomfortably wobbly in windy conditions and offers no protection against rain, lightning, and similar hazards.

ARMADILLO MPT TWO-MAN TENT

Availability: Any
 Cost: \$135
 Mass: 1 kg
 Stock No.: 330SH1003

Easy setup, easy strike-down, light weight, and easy stowage—what more could you want from a two-man tent? No more hassling with support poles; a single numaplas support matrix inflates with a handy foot-pedal, providing a structure lighter and stronger than aluminum. Let out the air, and the Armadillo collapses down to a soft carry-bag about 20 cm on a side in a matter of moments. Its 100% water-repellent smart fabric breathes in hot weather and insulates in cold temperatures. Six spring-loaded self-driving tent pegs are included for securing the Armadillo to uneven ground or in windy conditions.

WATERCADDY 100

Availability: Common
 Cost: \$275
 Mass: 3.5 kg
 Stock No.: 370CW5856

What's the heaviest thing you'll carry on an overland hike in the back country? Water, of course! Our WaterCaddy eliminates the need for you to carry 10 or 20 kg of water by providing you with the ability to purify or condense your own water from the local environment. The WaterCaddy sets up in just moments, and purifies up to 1 liter of contaminated or brackish water per minute—just pour into the top grill and catch delicious drinking water at the bottom spigot!

If standing water on the surface isn't available, twist

and open the WaterCaddy to deploy its condenser net, then turn on its cooling unit. You'll condense 1 liter of water every 10 minutes in humid conditions, 30 minutes in average conditions, 60 minutes in dry weather, and 120 minutes in super-arid weather. The WaterCaddy's power cells provide enough energy for up to 2 months of purifier mode operation, or 2 weeks of condenser operation.

PLANETWIDE CLIMATE WEAR

Why is it that some of the most interesting and economically attractive worlds have some of the most intolerable climates? At last count, roughly one in four people live or work in nonterrestrial environments, and that minority is increasing every day. Clearly, you'd better be ready to handle the worst planetside and open-space conditions if you want to stay ahead of the competition.

Our award-winning PlanetWide collection features the best extreme-environment gear you can find anywhere. When it's your life on the line, why settle for second best?

SUNRUNNER 60 CLIMATE SUIT

Availability: Common

Cost: \$825

Mass: 1 kg

Action Penalty: 0

Environmental Tolerance:

Gravity: n/a

Radiation: R0-R3

Atmosphere: A1-A4 (with mask)

Pressure: P1-P3 (with mask)

Heat: H1-H3

LI/HI/En: d4-2/d6-3/d6-4

Stock No.: 430WC6880

Lighter and more comfortable than an e-suit, the Sunrunner is designed to keep you safe and cool in non-vacuum extraterrestrial environments. Its sophisticated heating/cooling elements keep you comfortable in arctic to torrid environments. With the matching respirator mask, the Sunrunner allows long-endurance work and travel in environments with toxic, thin, dense, or mildly corrosive atmospheres.

While many standard jumpsuits or e-suits meet the same environmental criteria, the climate suit's real strength is its long endurance. It's meant to be worn for days at a time, and features drinking, feeding, and elimination systems to allow a suited worker to stay on the job for as long as it takes. Provided the wearer has access to water, food, and a respirator, he can remain suited for up to 30 days before the climate suit's lantth cells require recharging.

ORBITER C1 SOFT ENVIRONMENT SUIT

Availability: Common

Cost: \$1,500

Mass: 2.5 kg

Action Penalty: +1

Environmental Tolerance:

Gravity: G0-G3

Radiation: R0-R3

Atmosphere: A0-A4

Pressure: P0-P3

Heat: H0-H4

LI/HI/En: d6-3/d6-2/d4-2

Stock No.: 400WV7904

If you live or work in space, sooner or later you'll need an e-suit. Made from advanced polymere weaves, the Orbiter C1 is an outstanding suit for open-space work. It's light, tough, and durable, with a spacious helmet and chestplate-style support unit that keeps all the vital read-outs and controls in easy sight and reach, right where you need them.



Sunrunner 60 Climate Suit

The suit's lanthanide power cells provide up to 80 hours of continuous operation for the onboard control module and heating/cooling elements. Instead of a bulky air tank, the Orbiter has a rebreather system with an oxygenator cartridge that provides 12 hours of O₂ in a small, 1-kg package (not included in the listed suit mass). The rebreather system includes two regulators and a switch valve, so you'll be able to change out oxygen cartridges in open space without interrupting your air supply—a big advantage over some competitors' designs! Many experienced spacehands have recorded EVAs of 20 to 30 hours in the Orbiter C1, carrying two or three spare oxygen cartridges.

The Orbiter includes a multiband suit communicator with a range of 10,000 km in open space or 1,000 km on a planetary surface. Additional oxygenator cartridges cost \$25 each, and additional power cells cost \$50 each.

EXPLORER D9 ARMORED ENVIRONMENT SUIT

Availability: Controlled

Cost: \$4,500

Mass: 12.5 kg

Action Penalty: +2

Environmental Tolerance:

Gravity: G0–G3

Radiation: R0–R4

Atmosphere: A0–A5

Pressure: P0–P5

Heat: H0–H4

LI/HI/En: d6–1/d6/d6–1

Stock No.: 400AV2548

If vacuum is only one of your environmental worries, you'll want the Explorer D9. Made from cerametal plate and ultratough polymere weave, its advanced materials actually get stronger under pressure. Because the suit is virtually impervious to any kind of terrestrial or subterrestrial environment, only the most intolerable heat or intense gravity can threaten a traveler wearing the Explorer.

As with the Orbiter C1, the Explorer's onboard lanth cells provide enough power for 80 hours of continuous operation. Its heavy-duty rebreather system provides 12 hours of oxygen in a 1-kg cartridge that can be changed out in any environment without interrupting the air supply. For an extra \$2,500, the Explorer can be fitted with an exoskeletal support system, permitting normal motion and activity in gravity up to G4, and increasing the wearer's Strength score to 15 for purposes of lifting or breaking objects.

The Explorer's control module includes a multiband suit communicator with an open-space range of 10,000 km or 1,000 km on a planetary surface. Additional oxygena-

E-SUITS AND DAMAGE

E-suits are lined with a self-sealing, puncture-resistant inner layer. This prevents small tears, punctures, and cuts from depressurizing the suit. In the Gravity Age, the ability of e-suits to retain their integrity despite being damaged is improved over the durability of earlier versions. When the wearer of a soft e-suit is struck by an attack, the suit loses integrity only if the wearer suffers 4 points or more of primary wound or mortal damage (i.e., the wound or mortal damage exceeds the armor roll of the suit by 4 points or more). For example, if a suited character is struck by a 9mm bullet that inflicts 5 wound points of damage, his suit is breached only if he gets a result of 1 (or lower) on the armor roll. On the other hand, a plasma gun that inflicts 8 points of wound damage will breach the suit if the armor roll is a 4 or lower, since at least 4 points of primary damage will penetrate. Hard e-suits are only breached if the wearer suffers 4 points or more of mortal damage.

When a suit loses integrity, the wearer usually perishes quickly from exposure to vacuum. However, all suits include a suit patch kit in a thigh or hip pocket. Patching the suit requires a single successful Technical Science–*repair* skill check by the injured hero or someone near enough to aid him, and the character may attempt one check per action. If he's lucky, he'll patch the suit before perishing from exposure to vacuum (see "PO: Vacuum" in Chapter 3 of the *ALTERNITY Gamemaster Guide*).



Explorer D9 Armored E-Suit

tor cartridges cost \$25 each, and additional power cells cost \$50 each.

GILL A4 RESPIRATOR MASK

Availability: Any
 Cost: \$60
 Mass: 0.5 kg
 Action Penalty: 0
 Environmental Tolerance:
 Gravity: n/a
 Radiation: n/a
 Atmosphere: A2-A3
 Pressure: P1-P3
 Heat: n/a
 Stock No.: 500MR9004

Who wants to dress out for vacuum unless it's absolutely necessary? If you work in an environment that checks out in every category except the atmosphere, try out the A4 respirator mask. Its microengineered membrane filter screens out everything except nitrogen-oxygen, rendering toxic and mildly corrosive atmospheres safe (provided there's at least some free oxygen available, of course). It's even useful for protection against tear gas and other gaseous agents that work on the respiratory system.

The Gill A4 uses your own inhalation and exhalation to key a pressure inducer/reducer mechanism, helping you breathe comfortably in unusually thick or thin atmospheres. It's completely self-powered and self-contained, so there are no power cells to keep track of and no filter cartridges to fumble with or lose. Supplies are limited, so make sure you get yours today!

VACMASTER 77 VACUUM MASK

Availability: Any
 Cost: \$125
 Mass: 1 kg
 Action Penalty: 0
 Environmental Tolerance:
 Gravity: n/a
 Radiation: n/a
 Atmosphere: A0-A3
 Pressure: P0-P3
 Heat: n/a
 Stock No.: 500MV8564

In space, you're never more than 30 seconds away from one of the most grisly and agonizing deaths imaginable—exposure to vacuum. Stack the odds in your favor with the VacMaster 77 vacuum mask. From its compact stowage container on the belt, thigh, or hip, the VacMaster can be donned in a mere 3.23 seconds by the average person. Go ahead, try it out—we have!

The VacMaster has two main components: a hood of soft, transparent polymere, and a respirator cartridge. The hood is loose and easy to pull on, and once in place, transparent numaplas channels inflate to form a firm seal around the neck and add rigidity to the helmet. The respirator cartridge is a miniature version of the oxygenators/rebreathers found on full e-suits, connected by two circulation tubes to the mask itself. Pull the pin, and you've got 4 hours of air in the blink of an eye!

NOTE: The VacMaster provides protection to the head and respiratory system only. You may experience irradiation, vacuum-induced blood vessel damage and bruising, burns, or lethal heat loss without a full-body protective garment. The VacMaster is an emergency device only.

SOLAR X VEHICLES

Every planet has an outback—the wide-open spaces, the tough terrain, the rugged patches. The places no one but the most determined hikers, bikers, and fliers discover, the places that everyone else doesn't want to be. And that's where you belong. After all, the only way you'll ever get to know a world—to really find out what it's all about—is to get down onto its surface, get off the beaten path, and get lost in its outback.

We can help you do that.

Our line of off-road vehicles can get you anywhere you need to go. Mountains, swamps, forests, jungles . . . it's all the same to Solar X. With the right vehicle, you can cover ground that no one's ever seen, go places that no one's ever gone, do things no one's ever done.

And at Solar X, that's what it's all about.

SOLAR X GRIZZLY ATV GROUND CAR

Availability: Common
 Cost: \$55,595
 Mass: 2,650 kg
 Performance Characteristics:
 Drive: -1
 Acceleration: 40 meters/phase/phase
 Cruising Speed: 120 kph (60 kph rough)
 Maximum Speed: 240 kph (100 kph rough)
 Type: Good
 Durability: 14/14/7
 Stock No.: 910VT0297

You want power? The Grizzly's got it! This heavy-duty ground-pounder can take anything you throw at it. Powered by a Thomsen 60 fail-safe fusion plant, the Grizzly has enough endurance to circle a planet on 4 liters of water. Each of the vehicle's six wheels is independently powered by its own lanthanide-coil motor, giv-

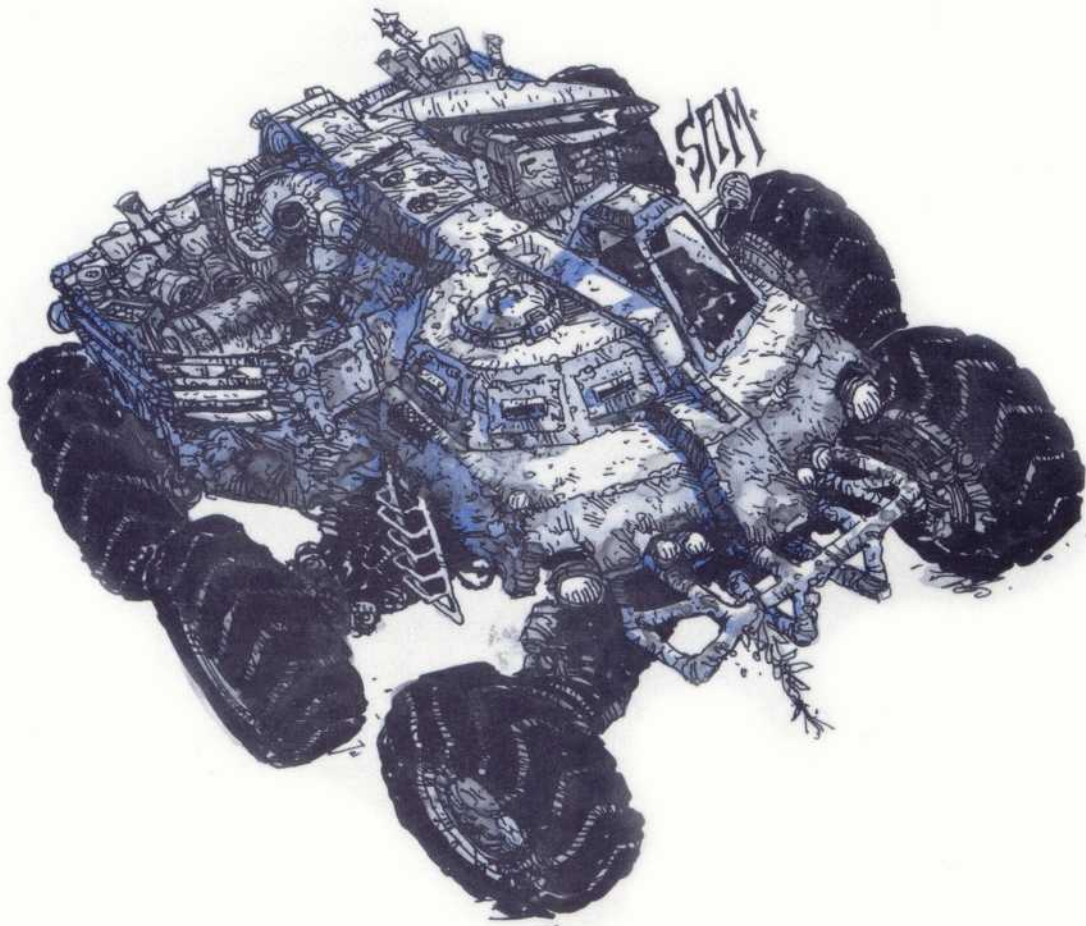

Solar X Grizzly ATV Groundcar

ing the Grizzly the best acceleration and maneuverability in its class.

The Grizzly's passenger cabin seats six comfortably, and the seats fold down to reveal sleeping arrangements for four. Its bed is large enough for a pair of ATV ground-bikes, a small aircraft or raft, or an additional four passengers with the optional camper extension (an extra \$1,000). A 500-kg winch is mounted on the front brush bar, and a powerful multiband communicator with a 1,500-km range is included in the vehicle's control console.

The Grizzly's independent drive and suspension gives it an impressive 75-cm ground clearance. Its engine compartment and drive systems are completely sealed, and the ATV can wade streams or rivers up to 2 meters deep with no problem. Finally, the Grizzly's polymere construction gives it armor protection of d6 (LI), d4 (HI), d4 (En).

Don't forget—Grizzlies go where they want to go, and everyone else gets out of the way.

SOLAR X CONDOR SKYCAR

Availability: Common

Cost: \$41,225

Mass: 1,040 kg

Performance Characteristics:

Drive: -1

Acceleration: 200 meters/phase/phase
(100 ground-effect)

Cruising Speed: 1,000 kph (300 ground-effect)

Maximum Speed: 3,000 kph (500 ground-effect)

Type: Good

Durability: 12/12/6

Stock No.: 920VA4972

The Condor is big, fast, and mean. When you're flying just above ground level at 1,000 kph in uncharted wilderness, you don't want a fancy flitter; you want an angry wildebeest with power to muscle its way through the worst flying conditions. That's the Condor.

The Condor's roomy cabin seats five passengers comfortably, and if you're going to be out in the field a long time, you'll find that the seats convert into two spacious

bunks. The cabin is completely airtight, and you can set the environment controls for exterior air supply, filtered exterior air supply (A3, P1–P3 atmospheres) or interior air supply (A0–A4, P0–P4) for up to 12 hours on the Condor's oxygen tanks.

The Condor features the best avionics package available, with an air/space radar featuring a special terrain-following mode, GPS and inertial navigation systems, meteorological instruments, and powerful visible/infrared headlights for low-light operation. You'll never have to worry about getting lost in this flier!

Powered by a Thomsen 55 fail-safe fusion generator and a gravity induction drive, the Condor won't run out of power at a crucial moment and doesn't need air under the wings to stay aloft. Its tough polymere skin provides armor worth d4 (LJ), d4 (HI), d4–1 (En).

Take the Condor anywhere, anytime—that's the Solar X motto.

SOLAR X INVADER ATV CYCLE

Availability: Common

Cost: \$8,985

Mass: 135 kg

Performance Characteristics:

Drive: 0

Acceleration: 60 meters/phase/phase

Cruising Speed: 100 kph (60 kph rough)

Maximum Speed: 150 kph (100 kph rough)

Type: Good

Durability: 5/5/3

Stock No.: 920VC3050

Get wet. Eat turf. Kick up mud.

If you're tired of watching the world go by outside a window, you're ready for the Solar X Invader. Four wheels, one seat, and power to spare—don't just visit the outdoors, invade it!

The Invader has a Thomsen X30 fuel cell engine, burning Oxymite™ self-oxygenating liquid fuel. The X30 engine powers independent motors in each wheel hub, providing four-wheel drive with great ground clearance. The Invader's 10-liter tank provides a range of 500 km; each liter of fuel weighs 2 kg and costs \$10. Since the fuel burns itself, the only thing in the Invader's exhaust is excess heat. If you don't like to carry fuel, ask for the optional lanthanide power pack, a battery cell that provides a range of 200 km. Recharging the lanth cell costs \$50.

Both Invader engines are watertight and require no air, so the ATV can ford anything that isn't over the rider's head. A multiband communicator and a GPS navigation module are standard equipment.

Don't delay—get yours today!

SOLAR X FALCON SKY CYCLE

Availability: Common

Cost: \$20,295

Mass: 285 kg

Performance Characteristics:

Drive: –2

Acceleration: 250 meters/phase/phase

Cruising Speed: 600 kph (300 kph ground-effect)

Max Speed: 1,200 kph (600 kph ground-effect)

Type: Good

Durability: 4/4/2

Stock No.: 920VC8503

Nothing flies like a Falcon. Speed, maneuverability, endurance—the Falcon's got it all. Featuring a new body style this model year, the Solar X Falcon is the best way to cover a lot of territory fast while staying part of the wilderness around you. Anyone can climb into a skycar and hit supersonic speeds—but it takes a special kind of outdoorsman to do the same thing in a bike that's open to the air.

The Falcon is powered by a Thomsen X70 fuel cell engine, providing power to a gravity induction motor. Its 15-liter tank provides enough power for 5 hours of flight (roughly 20 minutes to the liter). Optionally, a lanth power cell can be installed, providing enough energy for 4 hours of flight. The Thomsen X70 is a non-air-breathing engine that runs on Oxymite self-oxygenating fuel; each liter costs \$10 and weighs 2 kg. A charge for the lanth cell version costs \$100.

The Falcon's standard instrumentation includes a multi-band communicator with a range of 1,000 km, a GPS navigation system, and a small air/space radar with 60% of the normal detection ranges for a radar of this type.

SOLAR X SPARROW GRAVBELT

Availability: Common

Cost: \$10,995

Mass: 15 kg

Performance Characteristics:

Drive: +1

Acceleration: 50 meters/phase/phase

Cruising Speed: 200 kph

Max Speed: 400 kph

Type: Ordinary

Durability: 3/3/2

Stock No.: 920VP3400

For ages, humans have dreamed about flying like birds; no machinery, no cocoon of steel and plastic, just the human body aloft in the clouds. The Sparrow gravbelt is the closest you'll ever get to that ancient dream. Powered by durable lanth cells, the Sparrow's arm- and ankle-mounted aerofoil sensors provide its simple microproces-

sor with all the input it needs to simulate true flight. That's right—no control panels, no knobs and dials, just the motion of your own body to key the Sparrow belt. Feel the thermals under your arms, nose over into a dive with a kick of your legs, soar gracefully over the landscape in an experience that can't be equaled by any other flying device!

The Sparrow's battery cells last for up to 4 hours of continuous flight, with an automatic fail-safe landing mode that brings you down before it runs out of power. The arm-sensors include an inertial compass for easy navigation and a small multiband communicator to stay in touch . . . or cut everything off, and soar in silence. With the Sparrow, it's up to you.

SOLAR X SPINNAKER PARAFOIL

Availability: Common

Cost: \$3,735

Mass: 4 kg

Performance Characteristics:

Drive: -1

Acceleration: 10 meters/phase/phase

Cruising Speed: 40 kph

Max Speed: 80 kph

Type: Ordinary

Durability: 8/8/4

Stock No.: 940VP5506

Powered flight is for wimps, you say? Well, our parafoil is the next best thing to free fall! The Spinnaker is the best example out there of Solar X's minimalist technology—a cutting edge invention without a single moving part.

The Spinnaker consists of a 10-meter strip of advanced carbonate fiber, roughly 2 meters wide. It's chambered and filled with ultralight gel that can stiffen the cloth into a rigid wing or alter its shape and contour to meet the changing conditions of wind, angle of attack, and pilot maneuvers. It can even serve as a simple parachute in the absence of any other commands! A small microcomputer controls dilating valves and bladders in the parafoil to mimic the pilot's motions. With skill (*Daredevil-specific (parafoil)* is appropriate) and practice, the pilot can fly with the agility of a bird.

The parafoil glides extremely well, dropping 10 meters for every 300 of horizontal flight. In the right conditions, it can gain altitude on thermals or strong winds.

TRAILTECH EcoTOUR GEAR

When you're 500 kilometers away from civilization, you'd better be able to look out for yourself. Our EcoTour camping accessories are built to rigorous standards for durability, ergonomic design, and simplicity. No matter where

you are or what you're doing, you can't go wrong with TrailTech!

TRAILTECH SUPERFLY CLIMBING GUARDS

Availability: Common

Cost: \$495

Mass: 2 kg

Stock No.: 190TE6610

Stick to sheer rock walls like a spider! SuperFly climbing guards give you traction on any surface. With gripping surfaces made of microengineered high-friction StickPlas™ and a smart, semirigid construction that locks your hands and feet into the smallest holds on demand, climbing guards are just the thing for the free climber who wants to tackle the big slopes.

SuperFly climbing guards consist of a pair of elbow-length gauntlets and a pair of knee-length boots or stockings, studded with millions of microscopic needles and hooks. They're considered to be climbing gear of Good quality, providing a -2 step bonus to any Athletics-*climb* skill checks. In addition, the climbing guards negate up to 3 steps of penalties for wet or smooth surfaces.

TRAILTECH S40 CLIMBING HARNESS

Availability: Common

Cost: \$115

Mass: 1 kg

Stock No.: 190TE0904

A chain's only as strong as its weakest link, and if you're climbing with substandard gear, you're not getting the

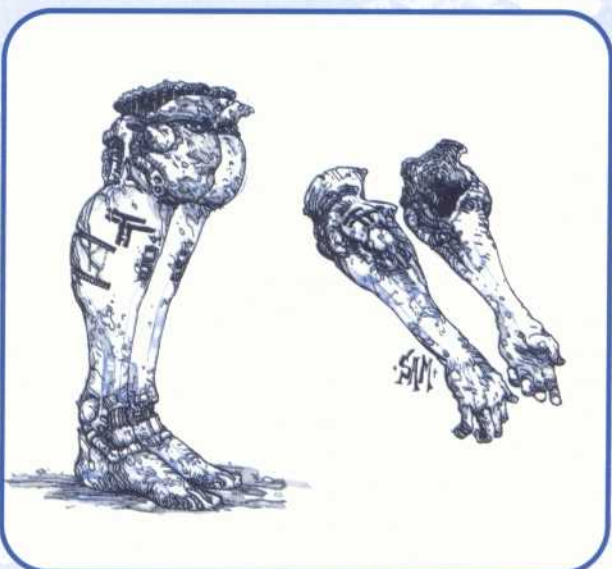

TrailTech SuperFly Climbing Guards

most out of your time and effort. The S40 is a top-flight climbing harness, light and strong, perfect for rappelling, safety rope attachment, or even long-endurance suspended work on vertical surfaces. Better yet, the S40 includes an adjustable frame for balancing a backpack and six attachment points for pitons, climbing tools, weapons, whatever you need to have with you.

The TrailTech S40 climbing harness—don't get vertical without it.

TRAILTECH PATHFINDER FLARE GUN

Availability: Controlled
Cost: \$175
Mass: 0.25 kg
Stock No.: 110TGO781

When you're in trouble, you need to be able to summon help fast. The Pathfinder flare gun is one of the best items of safety gear that you can take into the bush. It comes with six preloaded plasma flares that reach an altitude of 500 meters; toggle the flare for smoke or light at a flip of a switch when you fire the flare!

The Pathfinder's smoke flare can be seen up to 10 km away on a clear, bright day, while the light flare is visible up to 25 km distant on a dark, clear night.

CAUTION: It's dangerous to fire the Pathfinder at or near other people. The weapon inflicts $d4w/d4+1w/d4+2w$ of HI/O damage, with a +3 step penalty to accuracy. If the victim's armor fails to stop all of the Pathfinder's primary damage, the ignition of the flare inflicts an additional $d6w$ of energy damage per action round for the next $d4+1$ action rounds. The flare pistol's effective range is 10/50/500 meters.

Additional flares cost \$15 apiece.

TRAILTECH MINITORCH D30 FLASHLIGHT

Availability: Any
Cost: \$45
Mass: 0.1 kg
Stock No.: 140IE5344

You want a 10-kg searchlight in a 100-gram package? The Minitorch is just what you're looking for! No bigger than a good-sized wrist chronometer, its flat profile and Stickplas™ handle let you attach it to almost anything—your hat, your shirt, even the barrel of a pistol or rifle.

The Minitorch adjusts from a tight beam 60 meters long and 10 meters wide at the end to a wide beam illuminating a hemisphere 20 meters in radius. The torch's lanthanide cell lasts for up to 12 hours of continuous illumination before it requires recharging or replacement.

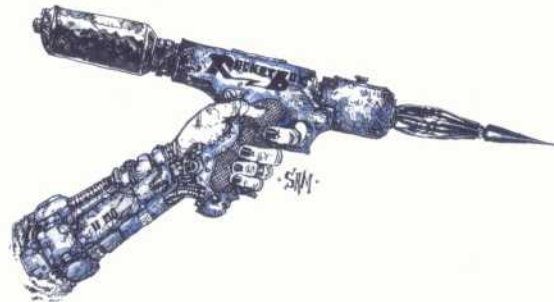

TRAILTECH ROCKETBOY SELF-PROPELLED GRAPPLE

Availability: Common
Cost: \$280
Mass: 5 kg
Stock No.: 150TE1989

Tough climbs demand tough tools. The RocketBoy is a compact grappling hook in a gunlike sleeve. When you pull the trigger, a replaceable charge-gun cartridge throws the hook and a trailing line over 200 meters straight up. The RocketBoy comes with one of three grapnels—a standard deploying-vane model for snagging branches, boulders, and other rough surfaces; a magnetic grapnel suitable for seating on ferrous surfaces such as a ship's hull; or a contact-glue grapnel that adheres to even the slickest and smoothest surfaces. (The glue-grapnel comes with three adhesive sleeves, since its adhesive supply and gripping surface must be replaced after each use.)

If it's necessary, Acrobatics—*daredevil* and Athletics are the skills most appropriate to firing and securing the grapple. Launch cartridges cost \$5 apiece; grapnels cost \$40 each, and additional adhesive sleeves for the glue-grapnel cost \$10 each.

TRAILTECH HOTSPOT POCKET IGNITER

Availability: Common
Cost: \$25
Mass: 60 grams
Stock No.: 150TE2302

Fire-building may be a lost art, but with the HotSpot you'll never have to worry about striking a spark or rubbing sticks together. This pocket-sized igniter is powered by a lanth cell guaranteed for one hundred lights. Instead of producing an open flame, the HotSpot heats an ignition

filament that you can use in all kinds of conditions—heavy rain, gusting winds, even underwater! At 600° C, the HotSpot doesn't take long at all to start even the greenest wood burning.

TRAILTECH K90 CARBON LAMP

Availability: Common
Cost: \$75
Mass: 1 kg
Stock No.: 160TE0832

Everyone likes to see the stars at night when you're out in the wilderness, but before you settle in for an evening of stargazing you want to be able to see enough to fix your dinner and wash your dishes. The K90 carbon lamp is one of the best outdoor lanterns around. At high power you'll marvel at a dome of bright light nearly 80 meters in diameter . . . or, if you prefer less intense illumination, use the dimmer switch to cut the K90 back to a soft glow. The carbon lamp relies on two Readyever lanthanide cells with an endurance of 48 hours at high setting, or 240 hours at low. It's completely watertight and can operate at full efficiency in any environment. Additional lanth cells cost \$5 apiece, or the lamp can be recharged for a nominal fee at any commercial power outlet.

TRAILTECH ROCKBITER ADHESIVE PITONS

Availability: Common
Cost: \$10
Mass: 0.1 kg
Stock No.: 190TE3284

Hammering pitons into rock is one of the most tiring and dangerous tasks a climber faces. At best, your arms are going to get bone tired and you're going to be up there all day; at worst, you'll shatter the spot you're trying to secure, or plant a piton that looks solid but won't hold when you need it most. The Rockbiter is the answer you've been looking for!

Manufactured from the finest magnesium alloy, these light, strong pitons are equipped with a spring-loaded adhesive sac at the business end. Just set it against the rock and push. Presto! Your piton's glued to the rock face, capable of supporting up to 700 kg of dead weight without breaking free—and even then, the Rockbiter holds while tearing out a divot of stone!

Adhesive pitons count as climbing equipment of Ordinary quality, and offer a -1 step bonus to any recovery checks the climber must make after a miscue in his climb. To be fully effective, pitons should be spaced no more than 5 meters apart.

TRAILTECH BUGZAP SONIC BARRIER

Availability: Common
Cost: \$85
Mass: 1 kg
Stock No.: 105TE8839

Mosquitoes, gnats, horseflies, ants—who wants to share a camping site with 'em? You sure don't! Fortunately, these pests are sensitive to ultrasonic vibrations that you can't even feel. Our sonic barrier creates a bug-free zone up to 20 meters in radius that most insects (and many other kinds of vermin) just can't tolerate! You'll be as safe and comfortable as you would be inside your own house. All you need to do is set the barrier module in the center of your campsite and flip the switch. The BugZap's battery lasts for up to 24 hours of continuous use.

SOLAR X SHIPYARDS

Stand out in the dark countryside of any human-settled planet and gaze up at the stars on a clear night. If you look long enough, you'll probably catch a glint of sunlight from a ship in high orbit, heading out to distant stars and alien suns. And in that moment, you'll feel a longing, a wanderlust, as old and strong as the stars themselves. That's the human nature—to gaze at the edge of the unknown and wonder what lies beyond.

At Solar X, we feel that it's our duty and privilege to place the key to the stars in your hands. Humankind has grown a lot in the last couple of centuries. Where once we looked no farther than Earth's horizons, now each and every one of us is bound together in a galactic community made of a thousand different worlds. Whether you're a businessman, merchant, or entrepreneur, there's only one place for you to be today—out in the infinite beyond that links us all, an endless ocean of commerce and discovery beyond the sky. And Solar X Shipyards can take you there.

HERMES-CLASS COURIER

Compartments: 4	Dur: 16
Maneuver rating: -1	Acc: 3 Mpp
Cruising speed: 2 AU/hr	Berthing: 14
Armament: Plasma cannon	
Range 4/8/16 Mm d6+2w/d8+2w/d6+1m En/A	
Defenses: Chaff dispenser, jammer	
Armor: Light cerametal (0 dur)	
	d6-1 (LI), d6-1 (HI), d6-1 (En)
Computer: Ordinary computer core, Ordinary navigation	
	dedicated computer
Engines: Induction engine	
Power: Mass reactor rated at 25 power factors	
Drive: None	

Roll	Comp't	Systems (Dur/Pow)	Durability
1-4	Command	Plasma cannon (3/3) Chaff (1/0) Multiband radar (0/0) Jammer (0/1) Laser transceiver (0/1) Radio transceiver (0/1) Airlock (0/0) Ordinary computer core (1/0)	10/10/5
5-7	Engineering	Induction engine (4/4) Autosupport (0/1) Reentry capsule (0/0)	8/8/4
8-12	Auxiliary	Mass reactor (4/*)	8/8/4
13-20	Crew	Crew quarters (1/0) Passenger suite (2/0)	6/6/3

Small and fast, the *Hermes*-class system couriers are built for high-speed interplanetary passenger and mail runs. Many larger warships carry system couriers like the *Hermes* as captain's gigs, admiral's barges, and crew shuttles. The *Hermes* is not equipped with a stardrive; she's too small to carry an interstellar drive. However, her small size allows the *Hermes* to hitch a ride with almost any driveship that comes along.

The *Hermes* is equipped with a forward-firing plasma cannon for defense, along with an excellent suite of sensors. She can easily be handled by a single pilot, but basic passenger/crew quarters for six hands, plus spacious staterooms for two passengers, are provided.

Hermes-class couriers are found throughout the Verge; it's been a very successful design for Solar X, and these slender ships are popular personal transports for high-ranking government and corporate officials in several systems. The *Hermes* also has a more sinister connotation—smugglers and crime lords are also known to favor the *Hermes*'s combination of speed, comfort, and style.

From the time the order is placed, the Solar X shipyard requires 6d4 weeks to build and outfit a new *Hermes*-class courier. On occasion, finished hulls may be available due to canceled orders or contract disputes; interested parties may be able to fly the ship out of the yard within a matter of hours if Solar X happens to have any completed hulls in their orbital facility awaiting a buyer. Cost: \$2,395,000

NIKE-CLASS GUNBOAT

Compartments: 8
Maneuver rating: 0
Cruising speed: 1.5 AU/hr

Dur: 40
Acc: 2 Mpp
Berthing: 12

Armament: 2 mass cannons
Range 5/10/15 Mm d6+2s/d6+1w/d6+3w LI/A
2 launch tubes w/20 missiles (8 CHE, 8 ARN, 4 SMP)
Defenses: Jammer, deflection inducer

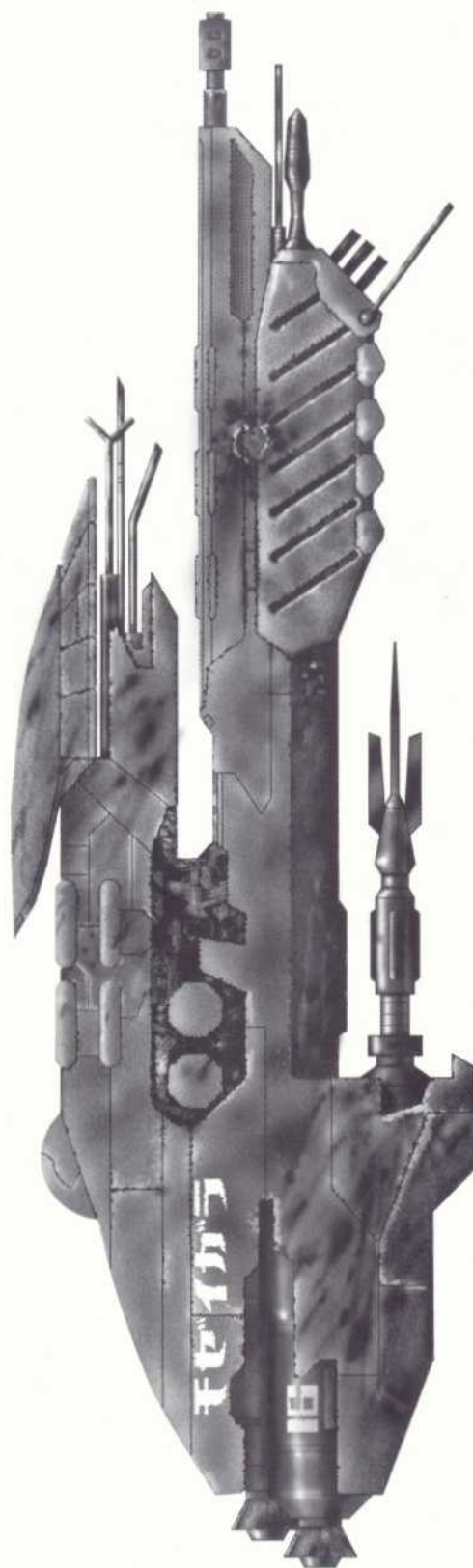

Hermes-class Courier Ship

Armor: Moderate neutronite (4 dur)
d6+1 (LI), d6+1 (HI), d6 (En)

Computer: Good computer core; Good battle and sensor dedicated computers; Ordinary engineering and navigation dedicated computers

Engines: Induction engine

Power: 3 mass reactors rated at 25 power factors

Drive: None

Roll	Comp't	Systems (Dur/Pow)	Durability
—	Command	Multiband radar (0/0) Laser transceiver (0/1) Radio transceiver (0/1) Crew quarters (2/0) Airlock (0/0) Good computer core (2/0) Reentry capsule (0/0)	8/8/4
1-2	Engineering 1	Induction engine (4/4) Mass reactor (4/*)	16/16/8
3-4	Auxiliary	Mass reactor (4/*) Autosupport (0/2)	8/8/4
5-6	Weapons 1	Launch tube (3/1) Mass cannon (2/3)	10/10/5
7-9	Electronics	Deflection inducer (2/4) Mass transceiver (1/1) EM detector (0/0) Mass transceiver (1/1) Jammer (0/1)	8/8/4
10-12	Engineering 2	Induction engine (2/2) Mass reactor (2/*)	8/8/4
13-16	Weapons 2	Launch tube (3/1) Mass cannon (2/3)	10/10/5
17-20	Cargo	Cargo space (2/0)	4/4/2

The largest and most powerful patrol craft produced by a private shipyard outside the Tendril system, *Nike*-class gunboats are becoming a common sight in lawless systems, defending corporate outposts and interests. Heavily armed with twenty missiles and two mass cannons, the *Nike* can outslug almost any noncapital ship it encounters. The standard boat is not equipped with a stardrive, and the *Nike* is used principally as a system defense ship.

A flotilla of over thirty standard and modified *Nikes* serves as the Calefir family's personal navy in the near portion of the Verge. At least one is on station in the Tendril, Aegis, Algemron, Lucullus, and Karnath systems at all times, and the Calefirs visit other nearby systems frequently. Other Solar X clients with *Nike*-class gunboats in their inventories include Grith, VergeTech, and a number of smaller companies seeking a basic defense asset for vulnerable mining colonies and trading posts.

While the *Nike* is well armed for its size, it's not especially fast and it's relatively short-ranged. Most experienced *Nike* skippers prefer to stay close to their assigned territory, recognizing that many faster ships can run right past their defenses given a chance. Cost: \$10,435,000

GULL-CLASS LAUNCH

Compartments: 2

Dur: 8

Maneuver rating: -1

Acc: 3 Mpp

Cruising speed: 2 AU/hr

Berthing: Special

Armament: Mass cannon

Range 5/10/15 Mm d6+2s/d6+1w/d6+3w LI/A

Defenses: Jammer

Armor: Moderate cerametal (1 dur)

d4+1 (LI), d4+1 (HI), d4+1 (En)

Computer: Marginal computer core

Engines: Induction engine

Power: Mass reactor rated at 5 power factors

Drive: None

Roll	Comp't	Systems (Dur/Pow)	Durability
1-6	Command	Mass cannon (2/3) Jammer (0/1) Multiband radar (0/0) EM detector (0/0) Radio transceiver (0/1) Airlock (0/0) Marginal computer core (0/0) Reentry capsule (0/0) <i>Special System: either Passenger suite (1/0); or Crew quarters (1/0); or Cargo space (1/0)</i>	6/6/3
7-12	Engineering	Induction engine (2/2) Mass reactor (2/*) Autosupport (0/1)	8/8/4

One of the smallest interplanetary craft manufactured anywhere, the Solar X *Gull* is usually found as a ship's boat or launch on larger vessels. Quick and responsive, the *Gull* is perfect as a planetary excursion vehicle. While it's capable of supporting its crew for weeks on end in interplanetary space, most pilots feel that it's just a little too small for outer-system travel, where a mishap might strand a ship billions of kilometers from any safe haven. It's also notoriously underpowered, as it's quite impossible for the crew to power up all of the ship's systems at once.

The *Gull* can be configured to carry a 1-point crew section (6 hands), a 1-point passenger section (4 passengers), or a 1-point cargo hold (roughly 30 cubic meters of cargo). It takes about 4 hours to rearrange the internal partitions and bulkheads in order to set up the shuttle's interior for one of these three functions. Typically, the shuttle is left in crew configuration, although wealthy jet-setters often custom-order *Gulls* with exceptional passenger facilities, using them as private transports. Cost: \$1,425,000

ARMOR, SHIELDS, AND E-SUITS

Armor	Skill	AP	Type	LI / HI / En	Hide	Mass	Avail	Cost
Battlehawk Zero-G Assault Gear	combat	+2	0	d6-1 / d6 / d6-1	-	8	Com	3250
Scout 230 AET Assault Gear	combat	+2	0	d6 / d8 / d6-1	-	12	Mil	4400
BodyGuard Ballistic Vest	-	0	0	d6-1 / d6 / d6-2	+3	3	Com	750
Landsknecht 34 Ballistic Jacket	Armor Op	+1	0	d6-1 / d4+1 / d4-1	+1	6	Com	1650
Haramaki 200 CF Coat (long)	-	0	0	d4 / d4 / d6-2	+3	3	Com	800
Haramaki 100 CF Coat (chort)	-	0	0	d4-1 / d4-1 / d6-3	+3	2	Com	500
Milano GX CF Bodysuit	-	0	0	d8-1 / d8-1 / d6	+2	3	Com	2250
Dauntless 29 Attack Armor	combat	+2	0	d4+2 / d6+2 / d6	-	12	Com	3300
Tiger mod 6 Powered Armor	powered	+2	G	d6+1 / d6+2 / d6	-	25	Mil	9000
ACN 4 Cerametal Armor	combat	+2	0	d6+1 / d8+1 / d6	-	10	Mil	2000
Buchmaster Cerametal Mail	Armor Op	+1	0	d4+2 / d6 / d6	+1	7	Com	2650
ABM-5 Paladin Battle Armor	powered	+4	G	2d4+1 / 2d4+1 / 2d4	-	60	Res	25000
ABS-11 Dragoon Recon Armor	powered	+3	G	2d4+2 / 2d4+2 / 2d4+1	-	50	Res	35000
AAS-23 Titan Assault Armor	powered	+5	G	3d4 / 3d4 / 2d4+2	-	80	Res	50000
Aegis 650 Cerametal Shield	combat	+2	0	+2 / +2 / +2	-	1.6	Com	225
SAI Powered Shield	powered	+1	0	+3 / +2 / +2	-	8	Com	6500
Rampart Deflection Inducer	-	0	0	+2 / +2 / +1	+4	1.2	Com	1350
Anvil 44 Magnetic Screen	-	0	0	+3* / +3* / +2*	0	3.5	Res	7500
Alpha 50 Particle Screen	powered	+1	0	d6-3 / d6-2 / d8-2	-3	12	Mil	8500
SCM-16 Capacitor Screen	powered	+1	G(A)	Special	-2	8.5	Res	15750
Khe! burund	combat	+1	0	d6 / d6-2 / d6-2	-2	12	Com	3500
Ptokh k'se	-	0	0	d6+1 / d6 / d6-1	+2	2	Com	800
Bellweyn sil	-	0	0	d6 / d6-1 / d6-1	-	2	Com	6500
Had'niltas	powered	+1	0	2d4 / d6+1 / 2d4+1	+1	12	Res	25000
Sunrunner 60 Climate Suit	-	0	0	d4-2 / d6-3 / d6-4	-	1	Com	825
Orbiter C1 Soft Environment Suit	-	+1	0	d6-3 / d6-2 / d4-2	-	2.5	Com	1500
Explorer D9 Armored E-Suit	-	+2	0	d6-1 / d6 / d6-1	-	12.5	Com	4500

VEHICLES

Vehicle	Skill	Drv	Acc	Cruise	Max	Type	Dur	Avail	Cost
Solar X Grizzly ATV Groundcar	Land	-1	40	120	240	G	14/14/7	Com	55595
Solar X Condor Skycar	Air	-1	200	1000	3000	G	12/12/6	Com	41225
Solar X Invader ATV Cycle	Land	0	60	100	150	G	5/5/3	Com	8985
Solar X Falcon Sky Cycle	Air	-2	250	600	1200	G	4/4/2	Com	20295
Solar X Sparrow Gravbelt	Air	+1	50	200	400	0	3/3/2	Com	10995
Solar X Spinnaker Parafoil	Air	-1	10	40	80	0	8/8/4	Com	3735
Hermes-class Courier	Space	-1	3M	2AU	-	A	Hull 16/4	Com	2.4M
Nike-class Gunboat	Space	0	2M	1.5AU	-	A	Hull 40/8	Res	10.4M
Gull-class Launch	Space	-1	3M	2AU	-	G	Hull 8/2	Any	1.4M

CYBERNETIC EQUIPMENT

Item	Mass	Size	Cost per Quality			Item	Mass	Size	Cost per Quality		
			O	G	A				O	G	A
Artificial Ear	0.1	1	1000	2000	4000	Deflection Web	3	2	3500	-	-
Artificial Eye	-	1	1000	2000	4000	General Purpose Implant:					
enhanced	-	1	2000	4000	8000	Ordinary	1	2	\$500	-	-
Scanner Implant:						Good	3	3	-	1000	-
Ordinary	-	2	1250	-	-	Amazing	10	4	-	-	2000
Good	-	1	-	2500	-	Comm Port	0.1	-	500	1500	2500
Amazing	-	-	-	-	3750	Gunsight	0.1	-	1500	2500	4500
Endoskeleton	15	3	4000	6000	8000	System Link	0.3	1	1000	2000	4000
Subdermal Armor	15	2	1500	3000	6000	Accelerator	0.075	-	2500	5000	10000
Systemic Reinforcement	4	-	5000	10000	15000	Nanocomputer	0.15	1	2000	3000	4000
Cortex Bomb	0.1	1	1500	-	-						

MELEE WEAPONS

Weapon	Skill	Acc	Range	Type	Damage (D/G/A)	Actions	Clip Size	Clip Cost	Hide	Mass	Avail	Cost
Samurai 300 Ion Blade	Melee-powered	0	Personal	En/O	d4+3s/d6+4s/d4+3w	4	10	75	+2	2.25	Mil	750
Nighthawk A5 Pulse Baton	Melee-powered	0	Personal	En/O	d8s/d4+2w/d6+2w	3	10	75	+4	1.15	Com	500
PunkThumper 6000 Stun Baton	Melee-powered	0	Personal	En/O	d6+1s/d8+2s/d12+3s	3	10	75	+2	2	Com	425
AX2 Chainsword	Melee-powered	+1	Personal	LI/G	d8+1w/d8+2w/d4+1m	2	8	125	-	7	Mil	1250
Viper D Filament Blade	Melee-powered	0	4 meters	LI/O	d8-1w/d8w/d12-1w	3	20	75	+2	1.75	Com	1500
T-Bar TN Blade	Melee-blade	0	Personal	LI/G	d6w/d6+1w/d4m	4	-	-	+3	4	Com	500
Thunder 150 Gravmace	Melee-powered	0	Personal	LI/O	d8+2s/d6+2w/d8+2w	3	10	75	+1	3	Com	850
HeadBuster Power Cestus	Unarmed-brawl	0	Personal	LI/O	d4+2s/d4w/d4+2w	4	12	50	+3	2	Com	625
K-3 Zero-G Axe	Melee-powered	+1	Personal	LI/O	d6+2w/d4+4w/d4+2m	3	10	100	-	4	Mil	950
Chuurkhna	Melee-blade	0	Personal	LI/O	d4+3w/d6+3w/d6m	3	-	-	-	7	Com	350
Dai'sya	Melee-blade	0	Personal	LI/O	d4+1w/d4+2w/d4+3w	4	-	-	+2	1	Com	250
Tong fe	Melee-bludgeon	-1	Personal	LI/O	d6s/d6+2s/d4+1w	4	-	-	+2	1	Com	60

or Unarmed-power

RANGED WEAPONS

Weapon	Skill	Md	Acc	Range	Type	Damage (D/G/A)	Actions	Clip Size	Clip Cost	Hide	Mass	Avail	Cost
M9 9mm Charge Pistol	Mod-pistol	F	-1	8/16/60	HI/O	d4+1w/d6+1w/d4m	4	15	50	+3	1	Com	500
Hammer 5 11mm Charge Pistol	Mod-pistol	F	-1	10/20/80	HI/O	d4+2w/d6+2w/d4+1m	3	12	60	+2	1.20	Com	1000
K-Sat 100 9mm Zero-G Pistol	Mod-pistol	F	0	4/10/40	HI/O	d4+1w/d6+1w/d4m	3	15	50	+3	1	Com	400
ARZ 6mm Charge Autorifle	Mod-rifle	B/A	-1	60/150/400	HI/O	d6w/2d4w/d4+1m	3	-/30	125	-	2.75	Mil	2000
Bulldog 9mm Charge SMG	Mod-SMG	B/A	0	20/50/100	HI/O	d4+1w/d6+1w/d4m	4	-/8	100	+1	2.25	Mil	1750
IF-3 11mm Charge Rifle	Mod-rifle	F/B/A	0	90/180/600	HI/O	d6+1w/d6+3w/d6+1m	4	30/10	60	-	3	Mil	1600
AGC-7 Autoflechette Shotgun	Mod-rifle	F/B/A	0	10/20/50	HI/O	d4w/d6w/d4m	4	15/5	150	+1	3.25	Mil	2750
Devastator Flechette Pistol	Mod-pistol	F	-1	8/16/40	HI/O	d4w/d6w/d4m	3	6	50	+2	1.50	Mil	1450
Tornado 600 15mm Sabot Pistol	Mod-pistol	F	0	10/20/100	HI/O	2d4w/2d4+1w/d4+3m	3	6	60	+1	2	Com	900
MS 15mm Sabot Rifle	Mod-rifle	F	0	80/200/800	HI/O	d4+4w/d24+2w/d6+3m	2	12	100	-	4	Mil	4500
Nova 6 Mass Pistol	Mod-pistol	F	0	2/6/12	En/G	d6w/d6+2w/d6m	3	6	100	+2	1	Mil	1475
AAMG-12 Mass Rifle	Mod-rifle	F	-1	4/12/30	En/G	d6+1w/d8+1w/d6+1m	2	8	100	-	4	Mil	2450
Ninja 600 Laser Pistol	Mod-pistol	F	-1	20/40/150	En/O	d4+1w/d6+1w/d4m	4	20	50	+4	0.5	Com	1225
CLR-19 Laser Rifle	Mod-rifle	F	-1	100/600/1500	En/O	d6+1w/d6+3w/d4+1m	3	12	75	-	4	Mil	1800
Valkyrie 9 Autolaser	Mod-SMG	B/A	0	20/80/200	En/O	d6+1w/d6+3w/d4+1m	4	-/10	75	-	3.25	Com	1725
Falcon T9 Stutter Pistol	Mod-pistol	F	0	4/8/20	LI/O	d6+2s/d8+2s/d8+4s	3	10	50	+4	0.75	Com	375
Condor X7 Stutter Pistol	Mod-pistol	F	0	8/16/40	LI/O	d6+3s/d8+3s/d12+3s	3	8	60	+1	1.25	Com	850
Cyclone 700 Stutter SMG	Mod-SMG	B/A	0	10/20/80	LI/O	d6+2s/d8+2s/d8+4s	4	-/20	200	+1	3	Com	1000

RANGED WEAPONS (CONT.)

Weapon	Skill	Md	Acc	Range	Type	Damage (D/G/A)	Actions	Clip Size	Clip Cost	Hide	Mass	Avail	Cost
Sirocco 100 Stutter Rifle	Mod-rifle	F	-1	20/40/200	LI/O	d6+3s/d8+3s/d12+3s	2	12	70	-	3.50	Con	750
Tauri 9 Impact Pistol	Mod-pistol	F/B	0	4/12/36	LI/O	2d4s/d6+1w/d6+3w	4	12/4	50	+2	1	Con	1150
Apache LX Reflex Bow	Prim-bow	F	0	50/100/250	LI/O	d4+2w/d6+2w/d4+1m	2	1	25	-	1	Com	650
Commando 3000 Crossbow	Prim-bow	F	0	60/120/300	HI/O	d6+1w/d8+1w/d6m	1	1	25	-	2	Con	950
Cobra F77 Dart Gun	Mod-pistol	F	0	4/8/16	LI/O	d4-1w/d4w/d4+1w	2	6	100	+2	1.50	Com	450
Blue Bolt Arc Gun	Mod-rifle	F	-1	20/40/100	En/G	d8+1s/d8w/d6+3w	2	12	250	-	10	Mil	2750
Demon 9 Hand Flamer	Mod-SMG	F/B/A	-1	6/12/24	En/O	d6w/d6+2w/d8+3w	3	10/3	100	-1	4.5	Con	1200
Z-LOK Render Rifle	Mod-rifle	F	0	50/100/250	En/O	d6+1s/d6+1w/d4+1m	3	8	100	-	4	Res	2000

HEAVY WEAPONS

Weapon	Skill	Md	Acc	Range	Type	Damage (D/G/A)	Actions	Clip Size	Clip Cost	Hide	Mass	Avail	Cost
KZ 160 13mm Charge MG	Hvy-direct	A	-1	200/600/1200	HI/G	d8w/2d6w/d8m	4	-/50	2000	-	22.50	Res	9500
Ronin 900 25mm Sabot Cannon	Hvy-direct	F	+1	100/200/500	HI/G	d8w/d4+1m/d6+2m	2	20	200	-	10	Res	10000
Supernova X1 Mass Cannon	Hvy-direct	F	0	6/20/60	En/G	d8+1w/d12+1w/d8+1m	2	8	100	-	8.75	Res	6825
Roc Z1 Stutter Cannon	Hvy-direct	F	-1	20/40/80	LI/O	d6+2s/d8+3s/2d6+3s	2	10	100	-	15	Con	2500
Dragon 3 Heavy Flamer	Hvy-direct	F/B/A	-1	8/16/40	En/G	d6+1w/d8+2w/2d6+1w	2	15/5	200	-	8.50	Mil	2400
D16 Plasma Gun	Hvy-direct	F	0	50/100/400	En/G	d8w/d8+2w/d8+4w	2	8	100	-	6	Mil	12000
HAK-59 Quantum Minigun	Hvy-direct	F/B/A	0	40/80/200	En/O	d8+1w/d8+3w/d6m	4	90/30	300	-	10	Res	15000
ZK5 Grenade Launcher	Hvy-indirect	F	-1	40/240/480	As load	As load	3	10	varies	-2	2	Mil	1500
Bantam 5 Rocket Launcher	Hvy-indirect	F	-2	40/400/2000	As load	As load	2	4	varies	-	7	Mil	4000
Bloodhound F3 Smart Grenade	Athl-throw	F	-1	Per STR	As load	As load	2	-	-	+3	0.5	Mil	300

ROCKET AND GRENADE WARHEADS

Weapon	Skill	Md	Acc	Area of Effect	Type	Damage (D/G/A)	Actions	Clip Size	Clip Cost	Hide	Mass	Avail	Cost
Antiair Rocket	As launcher	F	Varies	4/8/12	HI/G	d4w/d4+2w/d4m	As launcher	-	-	-	3	Res	1000
Antipersonnel Rocket	As launcher	F	Varies	4/8/12	En/O	d6w/d6+2w/d8+2w	As launcher	-	-	-	3	Mil	500
Antivehicle Rocket	As launcher	F	Varies	0/2/4	HI/G	d4+2w/d4+4w/d4+1m	As launcher	-	-	-	3	Mil	1000
CHE Rocket	As launcher	F	Varies	6/10/16	En/O(G)	d8-2w/d8w/d4m	As launcher	-	-	-	3	Mil	250
AP Grenade	As launcher	F	Varies	0/1/2	En/G	d6-1w/d4m/d4+2m	As launcher	-	-	-	0.5	Mil	400
Concussion Grenade	As launcher	F	Varies	2/4/6	LI/O	d6+3s/d6w/d6+2w	As launcher	-	-	-	0.5	Mil	150
Frag Grenade	As launcher	F	Varies	2/6/10	HI/G	d8w/d8+1w/d4+1m	As launcher	-	-	-	0.5	Mil	100
Gas Grenade	As launcher	F	Varies	0/2/4	LI/O	d4s/d4+2s/d4w	As launcher	-	-	-	0.5	Mil	300
Pulse Grenade	As launcher	F	Varies	2/4/10	En/G	d4+2s/d6+2s/d8+2s	As launcher	-	-	-	0.5	Mil	350

TRANSVERGE NEWS PRIME REPORT

TUESDAY, AUGUST 15, 2501

VOIDCORP HOLDS SESHEYANS

BLUEFALL, AEGIS—Today VoidCorp denied appeals from eighteen sesheyans seeking an interstellar tribunal from the Galactic Concord. It is the third such appeal that VoidCorp has rejected in the last ten weeks. The denial drew protests from the Regency of Bluefall and the Galactic Concord.

The sesheyans involved in this particular dispute were arrested on Bluefall three months ago by VoidCorp law enforcement agents who claimed to have been tracking the group of eighteen as they followed a convoluted trail from the Corrivale system to the Aegis system. "Our corporation refuses to allow dangerous criminal Employees of VoidCorp to roam the stars and jeopardize the lives of innocents. These are wanted sentients," said spokesperson VY482 501BUL.

The sesheyans maintain their claim that the moon of Grith in the Corrivale system is their ancestral home, they are not native to the planet Sheya (which is under VoidCorp rule), and thus they have the right to travel throughout the known

Click SESHEYANS for more

STARMECH SURVEY TEAM FINDS WRECK

AJIKOR—Three weeks ago, in a distant, unremarkable system between Kendai and Tendril, a StarMech team of explorers discovered the remnants of a massive military ship. Yesterday, before a crowd of scientific investigators and historians, they announced their find and claimed the wreckage for the Collective.

The origin of the vessel remains unknown. "The floating debris was barely recognizable," said team leader Olivar Todan. "Only because of the molecular composition of the ship deck plates could we distinguish it from the natural space debris and comets in the system." The wreckage is thought to be one of the many starships destroyed during the far-ranging conflicts of the Second Galactic War, but until further analysis is done, no one will be able to identify it.

According to one hypothesis, that of Professor Jistri Toriso of the College of Verant-Benn, the ship may be the last of StarMech's so-called Warhulks, a type of vessel that disappeared from all military

Click WRECK for more

ALITAR MERCHANTS OUTRAGED

ALITAR, ALGEMRON—In a move that had been anticipated for days, the Concord Trade Commission today blocked transmission to Alitar of the most recent edition of Merrick's Personal Security Report. The CTC is acting under orders from the Concord Administrators to cease all arms traffic into the Algemron star system.

The action drew protest from both governments in the Algemron system, as well as from numerous merchants. "The unfortunate decision of the Concord does more than increase the likelihood of smuggling into the Algemron system," said General Wilken Murrad, commander of the 22nd Powered Infantry division on Alitar. "It's a violation of the same free expression that the Concord claims that it stands for. This issue is far from being settled."

While not a weapons catalog per se, the analysis of weapons and military hardware published by Colonel Merrick does include contact information for manufacturers—manufacturers that naturally contribute to Merrick's advertising revenues

Click EMBARGO for more

MARINE PLATOON DECLARED LOST

SPES, HAMMER'S STAR—After two weeks of search for a missing recon platoon, Concord Marine authorities officially called off the search, labeling the soldiers as missing in action. The recon platoon, a part of the 2nd battalion, 1st regiment, 145th division, was assigned to patrol a underpopulated region of the Mabillon continent on Spes. Contact with the platoon was lost unexpectedly while the Marines were on a routine reconnaissance mission.

In accordance with standard military procedures, patrols in the region will be stepped up for at least the next several weeks. Marines who were interviewed responded, on condition of anonymity, that morale in Alcazar and other encampments has reached an all-time low as a result of this and similar recent occurrences.

The disappearance of the recon platoon represents the second such event in the past seventeen

Click LOST for more

ARMS & EQUIPMENT GUIDE

by Richard Baker

The STAR^{DRIVE}™ Campaign Setting offers countless opportunities for making money—and just as many ways to spend it. The *Arms & Equipment Guide* is a 96-page illustrated book that describes hundreds of items for heroes to purchase, ranging from the mundane to the marvelous.

In these pages you'll find excerpts from catalogs and reports that list what's available. Of course, heroes have to know where to find what they want—and must have the cash to afford it, or the savvy to bargain for a better price:



➤ The catalog of the Rignunmor Star Consortium Merchant Exchange, offering a wide range of garments, personal items, medical gear, and professional equipment.



➤ VoidCorp's *CompuCatalog One*, the only place to go for the ultimate in computers, cyberware, and communications and sensor gear.



➤ Merrick's Personal Security Report, absolutely THE most comprehensive listing of Gravity Age personal weapons and armor ever compiled.



➤ The VergeTech Outfitters Spring Catalog, featuring the latest in survival gear and some high-ticket personal vehicles for those who want to travel in style.

Complete game statistics are provided for all the weapons, armor, vehicles, and other types of equipment, making this book immediately usable in any ALTERNITY® game.

U.S., CANADA, ASIA,
PACIFIC, & LATIN AMERICA
Wizards of the Coast, Inc.
P.O. Box 707
Renton, WA 98057-0707
+1-206-624-0933



EUROPEAN HEADQUARTERS
Wizards of the Coast, Belgium
P.B. 34
2300 Turnhout
Belgium
+32-14-44-30-44

Visit our website at www.tsr.com

ISBN 0-7869-1214-6



9 780786 912148

U.S. \$16.95 CAN \$21.95

EAN

Shop Till You Drop