

# BATTLETECH



## JIHAD HOT SPOTS: TERRA



## TEARING DOWN THE WALLS!

For more than ten years, the Word of Blake's Jihad has engulfed the states of the Inner Sphere and the invading Clans in chaos and fire. Reeling from attacks on all fronts, realms have fought one another while the Word's masters built a powerful Protectorate around humanity's home: Terra. But with the rise of a resourceful rebel leader, Devlin Stone, the collective might of the Great Houses and rival Clans have united for an all-out assault against the Protectorate—one that can only end when humanity's home is free once again!

*Jihad Hot Spots: Terra*™ continues the Jihad plot book series started with *Blake Ascending*, bringing readers into the latter years of the war between the Word of Blake and the Inner Sphere. Seen from the eyes of those who fight and die in this epic struggle, this book includes articles and intelligence excerpts from across the Inner Sphere, along with additional rules and campaign tracks for both *BattleTech* campaigns played using the *Total Warfare* and *A Time of War* game rules. This book also provides a rare, in-depth look at the Terran system itself, including the history and varied cultures who live on these most revered worlds. Also included are rules and units for the elaborate defense network the Word of Blake unveiled against Stone and his allied Coalition throughout the Protectorate campaign.

## TARGET: TERRA!

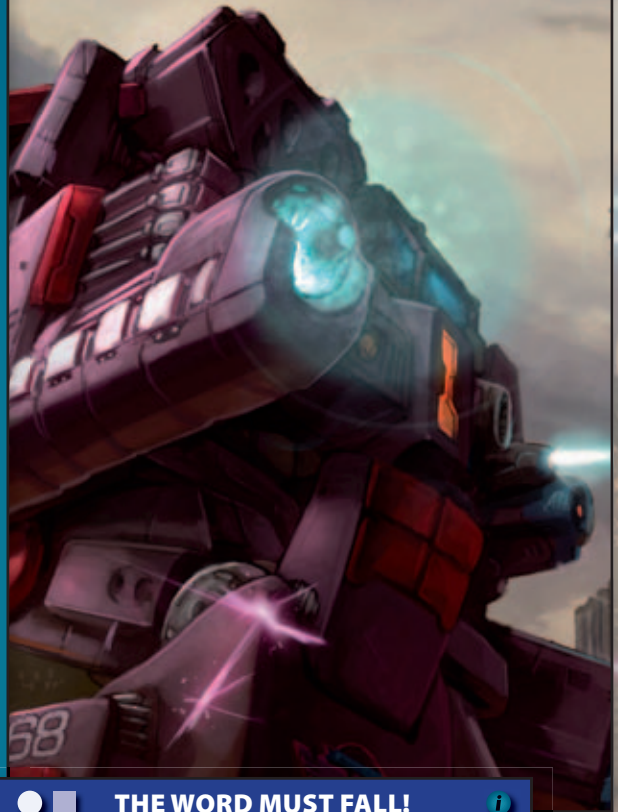

## THE WORD MUST FALL!



Under License From



STAR LEAGUE ERA



CLAN INVASION ERA



JIHAD ERA



SUCCESSION WARS ERA



CIVIL WAR ERA



DARK AGE

©2010 The Topps Company, Inc. All Rights Reserved. *Jihad Hot Spots: Terra*, *Classic BattleTech*, *BattleTech*, *BattleMech* and *Mech* are registered trademarks and/or trademarks of The Topps Company, Inc., in the United States and/or other countries. *Catalyst Game Labs* and the *Catalyst Game Labs* logo are trademarks of InMediaRes Productions, LLC. Printed in the USA.

WWW.CATALYSTGAMELABS.COM

**INN NEWS UPDATE...**

# Jihad Hot Spots: Terra



## TABLE OF CONTENTS



<b>MISPLACED CHILDHOOD</b>	4	Federation Build-Up	53	<b>Terra: The Attack Begins</b>	97
<b>INTRODUCTION</b>	10	Stone's Evil Stain	53	Mars Attacks?	97
<b>How to Use This Book</b>	11	Hall Surrenders Without a Shot	54	Hero of the Hour	98
About the Chaos Eternal Campaign	11	Nowhere Raided	54	Terror at Titan	98
<b>THE PROTECTORATE CRUMBLES</b>	12	Free?	55	Captain's Log	98
Civil Insurrection	15	Hegemony Arrives	55	Signals from Home	99
Signs of Things to Come?	16	The Mysterious Case of Northwind	56	<b>Terra: D-Day</b>	99
Big Doings on <i>Little Big Horn</i>	16	<b>Chaos Eternal, Part 1: 3077</b>	57	Begin the Assault	99
Righteous Fury	17	Watershed	57	The Final Dance	101
AFFS Reclaims Three Worlds	18	Ghost Tiger	58	Swarms	102
Autopsy of Dyeve	20	Blood and Fury	59	Destination: East	102
Horrors in the Funhouse	20	Charred Victory	60	Hell at Hilton Head	103
More Mercenaries Fleeing	22	Bridge to Oblivion	61	Calling Cairo	103
<b>3077: CLOSING THE CIRCLE</b>	22	<b>EARLY 3078: SMASHING THE WALLS</b>	63	Tokyo Secured	103
<b>The Lyran Front</b>	25	<b>Lyran Front</b>	64	Calamity at Sydney	104
Victory at Cor Caroli	25	3077: War in Review	64	Rio Goes Black	105
Return to Summer	25	Phecda: Tragedy and Triumph	65	<b>The Fall of the Word</b>	105
Sins of the Father	26	Failed Gambit	66	Beachheads Secured	106
Rumbles from the Republic	26	Rest and Refit	66	Scouring the Nile	106
Just a Setback	28	Traitors or Opportunists?	67	St. Jamais Escapes	106
Tipping the Scales	28	Assassination Plot	67	Pushing Through the Burragorang	107
Shiloh Falls	29	<b>Draconis Front</b>	68	Rio Captured; Dallas Burns	107
Where the Hell are They?	29	Threat Contained	68	Sandhurst Falls	108
<b>Draconis Front</b>	30	Saving Dragon Bacon	68	Mainland Pursuit	108
Official Update	30	Spirit of Cooperation	69	Breaking Krupps	109
Dead Clan Rising?	30	Fomalhaut, Epsilon Indi Liberated	69	Bloody Sunday	110
Outrage	31	What Lies Ahead	70	Cairo Front Stalls	110
Official Update 2	32	<b>Federated Front</b>	71	No Escape	111
Quentin Quagmire	32	Epsilon Eridani Liberated	71	Cairo Surrenders	115
Official Update 3	33	And a Davion to Lead Us All	71	Towra Point Falls	115
We Will Not Fade	33	Reclamation Ideals	72	Terra is Now Free	116
Official Update 4	34	Revenge	72	<b>And on Other Fronts ...</b>	116
<b>Federated Front</b>	35	Bryant Freed; Marking Time?!	73	Building the Walls	117
Forgiven, but Not Forgotten	35	Victory at New Home	73	Christmas on Gibson	118
Tragedy on Demeter	36	<b>Capellan Front</b>	75	Horror Show	118
First Wave Complete	36	Invaders at Hsien	75	Alert: Alshain	119
The Tale of Towne	37	Pity the Protestors	75	<b>Chaos Eternal, Part 3: Late 3078</b>	120
Liberated Archernar	37	Liberty is Ours!	76	Joyride	120
Snakes Still Snakes	38	Offers Rebuffed	76	Roadblock	121
War to the Knife	39	When Will They Come?	77	Ancient Meanings	123
Ingress, Fletcher Fall	39	Pleione Secured	77	Counterstrike	124
Sandoval-Ito: A Study in Success	40	<b>League Front</b>	78	Suffrage of Saints	125
<b>Capellan Front</b>	40	New Year, New Wave	78	End of Day	127
Liberation at Hand	40	The Push Continues	79	End of Night	128
What We Saw	41	Bethany Barrett: Oriente Hero	79	<b>AFTERMATH</b>	130
No Holds Barred	41	Terra's Doorstep	80	Where are the Shadows	131
Stone's True Colors	42	<b>And in Other News ...</b>	81	Mars: Approach	132
Death on a White Horse	43	Threat Level High	81	Mars: Assault	132
Vultures Circling	43	Transfer of Command	81	Mars: Victory	133
Public Enemy	43	Diplomacy, Please!	81	Corporate Chaos	134
<b>League Front</b>	44	Charges Filed	82	Severe Data Loss Possibly Widespread	134
Anyone Better?	44	The Truth on New Home	82	<b>TOURING TERRA</b>	136
Wasat Falls	44	Preparation or Withdrawal?	83	<b>Terran History</b>	137
Too Much to Handle?	44	<b>Chaos Eternal, Part 2: Early 3078</b>	85	The Twentieth Century	137
Overview: Alys Marik	45	Trick or Trap	85	Western Alliance	140
Talitha, Berenson Capitulate	45	Sticky Situation	86	The Terran Alliance: A Troubled Golden Age	143
Is Titus Capable?	46	Death to Tyrants	87	The Terran Alliance: Perversion and Downfall	145
Third Guards Defect	47	Pound of Flesh	89	Terran Civil War	146
Chara Operational Report	48	<b>LATE 3078: DESTINATION TERRA</b>	90	Terran Hegemony	147
A Traitor Within?	49	<b>Gathering Might</b>	91	Terra in the Hegemony	148
Atreus Darkened	49	Unprecedented Access	91	Terra in the Amaris Coup	152
Heir to No Throne	49	Recon Group 4	92	Terra Under ComStar	154
<b>And in Other News ...</b>	50	Seat of the Word	92	The Word's Terra	155
de la Sangre Missing?	50	Force Breakdown	93	<b>Terra: A People</b>	156
Regulus Ascending	50	Stone's Elite	93	A World of Diversity	156
Nightmarish Holiday	51	Time on Target	94	Government: The Branch of Terran Affairs	162
Hussars Crush Opposition	52	Roll Call	94	Economy	164



## TABLE OF CONTENTS

Life on Terra	166	Drake SDS Control Station	182	"Dragon's Breath" Multiple Capital Missile Launch System	200
Transportation	167	Cockatrice Monitor Platform Drone	183	<b>Castle Brian Game Rules</b>	203
<b>Terra: A Future?</b>	171	Hive-Class Drone Fighters	184	Underground Complexes	203
No Love for Blake	171	Dragon's Breath Multiple Capital Launch System	186	<b>Using Castle Brian Structures</b>	204
No Love for the Coalition	173	Rattler Mk. II Anti-Aerospace Mobile Fortress	188	Reinforced Weapons Bunker (RWB)	204
Terra: In the Short Term	174	Wyrms SDS Submersible Fortress	189	Command and Control Bunker	206
<b>RULES ANNEX</b>	177	<b>Drone Independent Command Rules</b>	191	Anti-Aerospace Bunker	206
<b>Word of Blake SDS Network</b>	178	<b>New Equipment</b>	194	Fortified Brian Wall	207
<b>New Units</b>	178	Aerospace Smart Robotic Control System (ASRCS)	194	Castle Brian Aerospace Hangar	208
Naga Caspar II Control Ship	178	Caspar II Advanced Smart Robotic Control System (CASPAR II)	196	Large Portal (Mobile Structure)	208
Dragau Assault Interceptor Caspar II Drone	180	Direct Tactical Analysis Control System (DTACS)	198	Castle Brian Weapon Emplacements	209
Tiamat Pocket WarShip Caspar II Drone	181	Advanced Robotic Transport System (ARTS)	199		

## CREDITS

### Writing

Joel "Welshman" Bancroft-Connors  
 Herbert A. Beas II  
 Craig Erne  
 Chris Hartford  
 Ken' Horner  
 Nick "Gunslinger" Marsala  
 Dana Maynard  
 Mike Miller  
 Jim Rapkins  
 Ben H. Rome  
 Adam Sherwood  
 Paul Sjardijn  
 Øystein Tvedten  
 Patrick "Roosterboy" Wynne  
 Andreas Zuber  
*Misplaced Childhood*  
 Chris Hartford  
*Chaos Eternal*  
 Nick "Gunslinger" Marsala  
 Ben H. Rome  
*Rules Annex*  
 Joel "Welshman" Bancroft-Connors  
*Additional Writing*  
 David L. McCulloch

### Product Development

Herbert A. Beas II  
*Rules Development*  
 Randall N. Bills

### Product Editing

Ben H. Rome  
*Editing Assistance*  
 Herbert A. Beas II

### BattleTech Line Developer

Herbert A. Beas II

### Production Staff

*Art Direction*  
 Brent Evans  
*Cover Art*  
 Klaus Scherwinski  
*Cover Design*  
 Matt Heerdt  
*BattleTech Logo Design*  
 Shane Hartley, Steve Walker and Matt Heerdt  
*Evolved Faction Logos*  
 Jason Vargas  
*Layout*  
 Matt Heerdt  
*Illustrations*  
 Douglas Chaffee  
 Brent Evans  
 Alex Iglesias  
 Aaron Miller  
 Mark Winters  
*Map (Devils Tower)*  
 Ray Arrastia  
*Record Sheets*  
 David L. McCulloch

### Special Thanks

To the entire *BattleTech* community, still with us after all these years! And to Randall Bills, for not giving up on us either. To the six "Herblets": Annie, Oscar, Meggie, Blaze, Logan (the lone canine), and our newest member: Kurita. And most of all to Rebecca "Beckie" J Beas, even when her patience wears thin with me...

### Playtesters and Fact-Checkers

Ray Arrastia, Ron Barter, Roland M. Boshnack, Paul Bowman, Rich Cencarik, Jason M. Donahue, Nicholai Duda, Bruce Ford, Joshua Franklin, William "MadCapellan" Gauthier, Tanic Half-Munchken, Keith Hann,

Térence Harris, Johannes Heidler, Glenn Hopkins, Daniel Isberner, Chris Marti, David M. McCulloch, Mike Miller, Darrell "FlailingDeath" Myers, Aaron Pollyea, Craig Reed, Rick Remer, Luke Robertson, Jason Robinette, Andreas Rudolph, Eric Salzman, Christopher K. Searls, Jason Schmetzer, Björn Schmidt, Chris Smith, Peter M. Smith, Joel Steverson, Geoff Swift, Chris "Chinless" Wheeler, Patrick Wynne.

© 2010 The Topps Company, Inc. All Rights Reserved. Jihad Hot Spots: Terra, Classic BattleTech, BattleTech, 'Mech, BattleMech, are registered trademarks and/or trademarks of The Topps Company, Inc. in the United States and/or other countries. No part of this work may be reproduced, stored in a retrieval system, or transmitted in any form or by any means, without the prior permission in writing of the Copyright Owner, nor be otherwise circulated in any form other than that in which it is published. Printed in the USA.

Published by Catalyst Game Labs, an imprint of InMediaRes Productions, LLC • PMB 202 • 303 91st Ave NE • E502 • Lake Stevens, WA 98258

### Find us online:

Precentor\_martial@classicbattletech.com  
 (e-mail address for any *BattleTech* questions)  
<http://www.classicbattletech.com>  
 (official *BattleTech* web pages)  
<http://www.CatalystGameLabs.com>  
 (Catalyst Game Labs web pages)  
<http://www.battlecorps.com/catalog>  
 (online ordering)

MISPLACED CHILDHOOD



AARON MILLER



## MISPLACED CHILDHOOD

**DEER LODGE, MONTANA**  
**NORTH AMERICA, TERRA**  
**BLAKE PROTECTORATE**  
**15 DECEMBER 3078**

"No, the left loader," Precentor Darius Ogden growled at his subordinate's incompetence. "Get it on the track and engaged!" He tugged the neck of his jacket up, tucking his chin back into the minimal protection of the collar, the frigid air burning his nostrils. The weak sunlight did little more than glint off his rank insignia; it was still twenty below out of the shade. He longed to be somewhere warm, but there was little chance of that.

Hurry up and slow down. That was the mixed message from command since the Unbelievers had invaded Holy Terra. Efforts to throw back the horde commanded by the arch-heretic Steiner-Davion and his cronies had proved ineffective, a far cry from the bloodletting that accompanied the disastrous "Case White" assaults not long after the start of the glorious Jihad to spread the Word of Blake across the stars. Geneva was lost, as were Singapore and Tokyo, though the heretics had been bloodied there and elsewhere. Matters looked grim, and St. Jamais had called all the faithful who could make it to converge on the Bear Lodge Supply Port, a suitable redoubt for the last stand against the fall of night that would follow should the heretics prevail.

And now this, forced out of the Court by advancing heretic forces and a desperate force-march to the bastion, only to suffer a blown drive train on the low-loader in the middle of this Blake-forsaken wilderness. He scowled at the stricken vehicle, sundry access panels open and machinery everywhere as technicians attempted to bring it back to life, incantations mixed with cursing and technical jargon. By rights they should press on but with supplies so scarce, abandonment of the vehicle and its precious cargo wasn't an option.

To say they were exposed was an understatement—Ogden glanced over his shoulder at the snowy expanse of the valley bottom, then back at the crews manhandling crates. At least it wasn't a wooded killing ground like the narrow terrain they'd sped through overnight. That really *was* bandit country, the territory of the Kalispell Witch, and he was surprised they'd made it through without major incident. He'd hoped to make Bozeman or even Billings before nightfall. But at *this* rate they'd be lucky to make Butte, and sitting out in the open was just asking for trouble, either from the bandits or the heretic orbital forces. Rumor had it that the barbarian Clans had thrown their lot in with the heretics, and it didn't take much to imagine them using orbital bombardment to mop-up St. Jamais' loyalists.

He checked his chronometer. Almost three hours stuck here now, and the chaos looked no nearer resolution. Too long. It was time to move.

"You and you," He gestured at the nearest workers. "Get those tied down and then get ready to—"

A low whistle rose into a tearing shriek, crossing from right to left just in front of him. Instinctively his eyes tracked the sound and noted the fist-sized crater in the side of the low-loader's cab. For an instant his frost and fatigue-addled brain struggled to comprehend what was happening, then his head snapped right, toward the origin of the sound. There was a brief flash on the edge of the distant tree line. "*Sni—!*"

Something punched him hard in the chest and he careened off the nearest crate like a rag-doll carelessly discarded by a child. He didn't feel the impact, but instead found himself wondering why the world was tilting alarmingly. His face came to rest on the powdery snow and he was distantly aware of the ice crystals burning his skin. Snow. The cold analytical part of his brain screamed for attention. Snow should be white, not red. It should be—  
 Blackness.



Sabrina Nial stomped her feet in a vain attempt to restore circulation. The icy wind knifed through her smock and coat as if they weren't there. She'd never felt so cold, even when skiing back on New Avalon. Then again, an afternoon out doing winter sports followed by the après-ski in a toasty lodge was a far cry from a troglodyte existence halfway up a frigid mountain. She'd been here ten days and already wanted to escape. The people she'd been sent to meet had been doing this for years. Decades even.

"A crisp morning," the rugged-looking woman said, grinning as she brushed aside the camouflaged tarp and emerged from the tunnel complex. Grey dominated the petite woman's hair, pulled back in a severe braid, but there were hints of red and gold that complemented her deep green eyes. Her face was weather-beaten, with a scar running the length of the left side of her face from temple to jaw. It was impossible to put a precise age to her—Sabi guessed at early sixties, but it could easily be ten years either way. "But at least it's not snowing." She carried a steaming tin mug in each hand and offered one to the AFFS officer.

Sabrina felt her fingers tingle as the mug's warmth seeped through her gloves, the start of pins and needles. She sniffed the contents gingerly; supplies were scarce here and this

## MISPLACED CHILDHOOD



was as like to be hot pine beer as coffee. The older woman laughed. "Coffee and a dash of Jimmy's hooch. It be nothing but the best for our guests. Cooked up nicely in the field oven you did be bringing."

*Assuming the hooch wasn't fermented axel grease*, Sabi thought. Jimmy Meeks was the band's mechanic, a man whose hands and face seemed permanently stained by years on the job.

Sabrina couldn't place the woman's accent. She'd thought Irish originally, but had been laughed at for the suggestion and guessing had become a game between the two of them.

Ops had given Sabi little in the way of background material on the band she was being sent to aid, just one of dozens of resistance cells who'd held out on Terra and had been contacted by Stone's Lament. But what the local resistance lacked in equipment and training, they more than made up for in zeal and efficiency. The taskforce had equipment in spades but needed people who knew the local terrain. And so here she was, in the godforsaken North American wilderness, providing technical support to the locals. Not that they seemed to need it; they were pretty much self-sufficient.

She sipped the hot beverage. Not as vile as she expected, but back home it might've gone straight down the sink.

Sabi cradled the mug, looking out across the wooded hillside, snow and dark trees in sharp contrast. It was deceptively beautiful, like much of Terra. Serene, with only the sound of branches clicking together in the breeze. For a moment she found it incomprehensible that they were in the middle of the largest military operation in centuries, but then she shifted to ease the pressure on her chilled feet - the pressure of the pistol on her right hip and the edges of the armor-polymer plates in her jacket brought Sabrina crashing back to reality.

The older woman tossed back the last of the coffee and with a sharp flick of her wrist sent the dregs into a nearby bush. "Company," she said, nodding toward a pair of white-clad figures climbing the slope. "News of our friends." The Blakists, the commander meant, running the gauntlet of the Rockies to escape the Coalition landings near the Court of the Star League on Puget Sound. There were almost too many targets for the band to choose from, so they had to pick their battles carefully.

The new arrivals approached wearily, as if they'd walked a long way in the snow. Both were swaddled in white, scarves wrapped round their necks and goggles covered their eyes. One was smaller and slimmer—a girl Sabi guessed—and carried an optical scope and a light assault rifle. The other

carried an older 50-caliber rifle, officially a light anti-armor gun but also favored for sniping. It was one of the "toys" Sabi had brought to the group and she frowned at the damage that'd been inflicted on the trigger guard.

"Jenn," the commander called, "there's coffee in the pot. Real stuff." The smaller figure gave an excited squeal and ducked into the tunnel. The gunman stood with the rifle resting on his shoulder.

"Not a bad piece of kit," he said, "though it pulls to the right a little. And—" He twisted the weapon to expose the trigger guard even more, or rather the metal stumps of where it had been. "—whoever designed it never considered someone trying to use it while gloved."

His black-goggled gaze seemed to challenge Sabi. "Or did they expect people to sit there with their pinkies exposed in twenty below?"

"Play nice, kiddo," the commander said. "Would you rather be using that old Makarov?"

The gunman pulled back the scarf and lifted the goggles so they sat atop his mop of red-gold hair.

Sabi gaped. He was sixteen, seventeen tops. The same age as her little brother. She recalled seeing him about the camp, but had assumed he was a message runner or some such.

"You're a child!" she blurted out. "What're you doing—?"

The boy scowled. "I've not been a child for a long time, Major Nial, not since the Blakists killed my father in front of me. Would've added me to their statistics had I not shot first." He jabbed a finger at her. "I was seven when Case White failed. Nine when I killed my first man. To you, this war has been going a decade. For some of us—" He gestured at the commander, the family resemblance obvious. "—it's been raging for twenty years." He held out the rifle. "This was the kind of 'toy' I grew up with. Don't call me a child." He stormed into the tunnel, not giving Sabi chance to respond.

The commander paused for only a moment, then shrugged. "You'll have to forgive my son. Nate can be a little touchy at times."

"My apologies. I didn't mean to cause offense. I was just caught off guard by his youth."

The commander made a dismissive gesture. "He'll get over it. Probably already has. Quicksilver temperament, that one. Like his father. And me I suppose." She grinned, then looked serious. "We fight with the tools we have, and that means my precious seventeen year-old is in the line, fighting for freedom and revenge. Sounds hokey, I know."

Sabi nodded. "It's what the Coalition is all about. What we're trying to do taking down the Blakists."

"Another war to end all wars?" She snorted, but the trace of a smile tugged at the corner of her mouth. "I was on





## MISPLACED CHILDHOOD

Tukayyid." She gestured to the scar on her face. "And those of us who went through *that* hellhole thought we be winning a respite for humanity." She gestured to the landscape around them. "So much for that." Her eyes flicked to the tunnel entrance as a parka-wrapped figure emerged and handed her a note. "Though I do be hoping that were in the end game now." Her eyes scanned the page before passing it over. "Your boss do be thinking so."



**SUNDANCE, WYOMING  
NORTH AMERICA, TERRA  
BLAKE PROTECTORATE  
16 DECEMBER 3078**

Powdery snow spiraled away from the chopper as its wheels touched down, the loadmaster gesturing for the trio of white-clad figures to leap clear under the watchful eyes of the waist-gunners. No sooner were they away than the pilot gunned the throttle and lifted clear, joining the mass of circling aircraft keeping a wary eye on the perimeter.

"Not been here for a while," the boy muttered. "'75 I think, after that excursion to Cheyenne."

"We were here back in '69 too," the commander said. "After Case White. When we stayed at the Mitchell place. Not that it looked like this then."

As far as the eye could see was a military camp, troops preparing to fight and vehicles being prepped. Numerous 'Mechs hung in mobile gantries while others marched along the perimeters. AA batteries jutted up toward the sky and the aerials of communications gear and electronic-warfare gear punctuated the skyline. There was a steady stream of trucks carrying equipment, and just as many on foot, dressed in a wide array of uniforms. All wore the Coalition insignia and the vehicles and 'Mechs were similarly marked; someone, at least, was thinking to minimize friendly fire.

Sabrina lowered the radio handset she'd been using. "The boss isn't at his CP but wants you to come up to Gantry Six." She gestured to the north, then tossed a small black rectangle to each of her companions, pinning one on her own chest. "Dosimeters. Our friends have been tossing nukes at Denver and elsewhere so we're likely to see more than just snow."

"They're at Mato Tipila?" The commander asked as they walked along a roadway that was equal parts mud and snow. She grinned at Sabi's blank expression. "Bear Lodge. The Devils Tower."

"How'd you know?"

"Who do you think let on the Robes had built a supply port there? That sort of work be rather hard to hide."

"This is us, I think." Sabrina gestured to the looming skull-headed behemoth nestled in the mobile gantry. "Time for me to make myself scarce."

"Been good working with you, Major Nial." The commander held out her hand and Sabi took it. The commander's handshake was surprisingly firm for such a petite figure.

"The pleasure's all mine." Her eyes glanced up at a figure descending from the *Atlas*. "You too, Nathan." She nodded at the boy who scowled back.

"Krimari, in the Magistracy." The commander stated, grinning. "You wanted to know about my accent." Sabi laughed and tossed her a salute before turning on her heels, attempting not to make her departure seem too hasty.

The descending figure was dressed in green overalls with a pistol in a shoulder rig. In his mid-thirties, he bore no rank insignia and hadn't shaved recently, his hair an unruly black mop. He could've easily been mistaken for a tech. But his eyes—intense and haunted—put the lie to that. There was little doubting that here was a person of importance. One of the techs handed him a towel, which he used to wipe grease from his hand before shrugging into a thermal jacket. He regarded the commander intently and offered his hand. "You'd be the Kalispell Witch, Edelle Kearny. Or do you prefer Edi Alexander? And Nathan, of course." He shook hands with the youth.

"You appear to be having me at a disadvantage, sir," Kearny stated flatly.

"Of course, my apologies. I forget my image hasn't been circulated on Terra. I'm Devlin Stone."



"Local knowledge." Stone gestured at Kearny with his left hand, a data pad held in his right. "Will be essential to victory."

They were in his command post, a holotable dominating the bunker and displays hanging from each wall. Techs in a plethora of uniforms operated the systems—ComStar, AFFS, FWLM—all feeding data to Stone's personal terminal. His appetite for data was insatiable; reports from the dozens of battles going on around the planet flooded in. It reminded Kearny of what she'd heard about Old Man Focht on Tukayyid, a giant swimming in data while coordinating that titanic clash.

## MISPLACED CHILDHOOD



Kearny eyed the short figure across the table from Stone, the pins of the Precentor Martial on the collar of his olive-drab uniform, arms folded across his chest. She knew of Victor Steiner-Davion, Focht's handpicked successor, but this was the first time she'd met the man who was her notional commanding officer. Despite his height he was an imposing presence—like Trent Arian, she recalled—but even he clearly deferred to the younger Stone.

"In all probability, St. Jamais has some nasty surprises in store for the Coalition, but he's not got much in the way of troops. Intel reports less than a level IV—probably only a couple of Level III's—but then Intel didn't know about Bear Lodge until Cameron bolted there. We only had your reports to go on."

Steiner-Davion typed a swift sequence on his data pad and a 3-D image of the butte appeared on the holotable. The massive and the instantly recognizable tower of rock dominated the image, the prefabricated buildings of the Bear Lodge Supply Port straddling the Belle Fourche River on the eastern side. A pair of *Union* DropShips sat on the pads, surrounded by cargo loaders.

"This is based on orbital imagery obtained on the twelfth," Stone said, "but as you can see it's a bit short of detail. St. Jamais has managed to keep the defenses concealed and we need a look-see on the ground." He regarded Kearny intently. "I hesitate to ask after all you've done and the price you've paid, but someone who knows the terrain would be invaluable in scouting the Tower. Can I count on you?"

Kearny's eyes flicked toward Nathan, then back to Stone. "That you can, Stone." She sighed. "A last huzzah, then we can all go home."

"Me too, General." Nate injected. "You'll not find a better scout."

Stone's eyebrows lifted, but it was Kearny who spoke. "No son, this is for me to do. I'll not send you into that hornet's nest." She regarded Stone intently. "He'll do good for you here if you can find a spot for him. You wanted local knowledge and he can give it to you."

Nathan scowled "But—"

"No buts, soldier. I'm your CO, as well as your mother." A smile tugged at the edge of her lips.

"Done," said the grizzled Stone, who nodded to Steiner-Davion. The Precentor Martial unfolded his arms and tossed a small box to Kearny. She opened it carefully, her eyes narrowing upon seeing the rank pins it contained.

"Welcome to the Coalition, Precentor Kearny." There was a hint of German in Steiner-Davion's accent, just like Old Man Focht. "There's a ride waiting for you at Carpenter's Creek. An *Avatar*."

Memories of Salinas and Gunnison flashed before her eyes. Images of good people lost in the Blakist sneak attack so many years ago. Time to finish what had started there. "Yeah, I know the model."



**SUNDANCE, WYOMING  
NORTH AMERICA, TERRA  
BLAKE PROTECTORATE  
17 DECEMBER 3078**

"Vampire! Vampire!" The alarm screamed and people in the command post pulled on NBC suits and respirators. It was chaos, but structured, some technicians pulling on their suits while others remained at their monitor posts. Nathan watched impassively—he had no monitor to watch—and he saw that Stone stood at the heart of the storm, unfazed by the doom rushing toward them. Fatalistic.

"What do we have?" he asked calmly, pulling data from several monitors.

"Fast movers," one tech called out. "Coming in NOE."

*Fighters*, Nathan thought, *using the undulating terrain to evade anti-air fire*. He recognized the distant buzz of chain-gun batteries firing. His eyes widened as he felt as much as heard the batteries in and around the camp opening up. There was a distant boom.

"Splash one. There's a second heading—"

The lights and displays flickered momentarily then resumed their full intensity. He heard a low rumble, followed by a tremor through his feet. The constant background hum off the bunker changed in pitch and he felt his ears pop. He glanced at Stone who'd held his nose, equalizing the pressure.

"Positive pressure. Keeps out the radiologicals," Sabrina said from her station to his right. "At least one of the bogies dropped their payload, though not on top of us." She had a hand pressed to one ear, holding a headpiece in place as she spoke. "Biologicals or chem too, from what the sensors are telling us."

"Where?" Stone's voice was a monotone.

"Three confirmed, two possibles. Pearce Reservoir—that's chem.—and The Mill." Her eyes widened and she turned to Nathan. "And Carpenter's Creek."





## MISPLACED CHILDHOOD

The mask concealed his tears, he was thankful for that as he pushed his way out of the bunker's pressure seal. He sniffed as he adjusted the impromptu weapon belt and its cargo of magazines. He reached for the rifle he'd carried from Deer Lodge but another hand grasped it first.

"Going somewhere, son?" Stone. He hefted the 50-cal and sighted along its length, stock flush against his respirator. He nodded appreciatively.

"North," Nathan said. "Hunting." He didn't have to say that his prey wore sword insignia, not fur.

There was a click as Stone dry-fired the rifle, inspecting the mechanism before handing it back to Nathan. "A good weapon. Dependable."

"It's okay." He loosened the strap and hung the weapon over his shoulder.

"You don't have to go. She might not have died."

Nate frowned. "Do you believe that?" He'd seen the mushroom cloud. Had known where his mother was meant to be.

"We'll know soon enough." The Coalition leader took the youth's shoulder in a firm grasp. "Good hunting son. You know where to find us when you're done."

Nathan stood to attention and saluted.



Stone returned the gesture, then stood watching the boy's receding back. He sighed. How had it come to this, when children knew nothing but war? It had to end.

*It had to.*

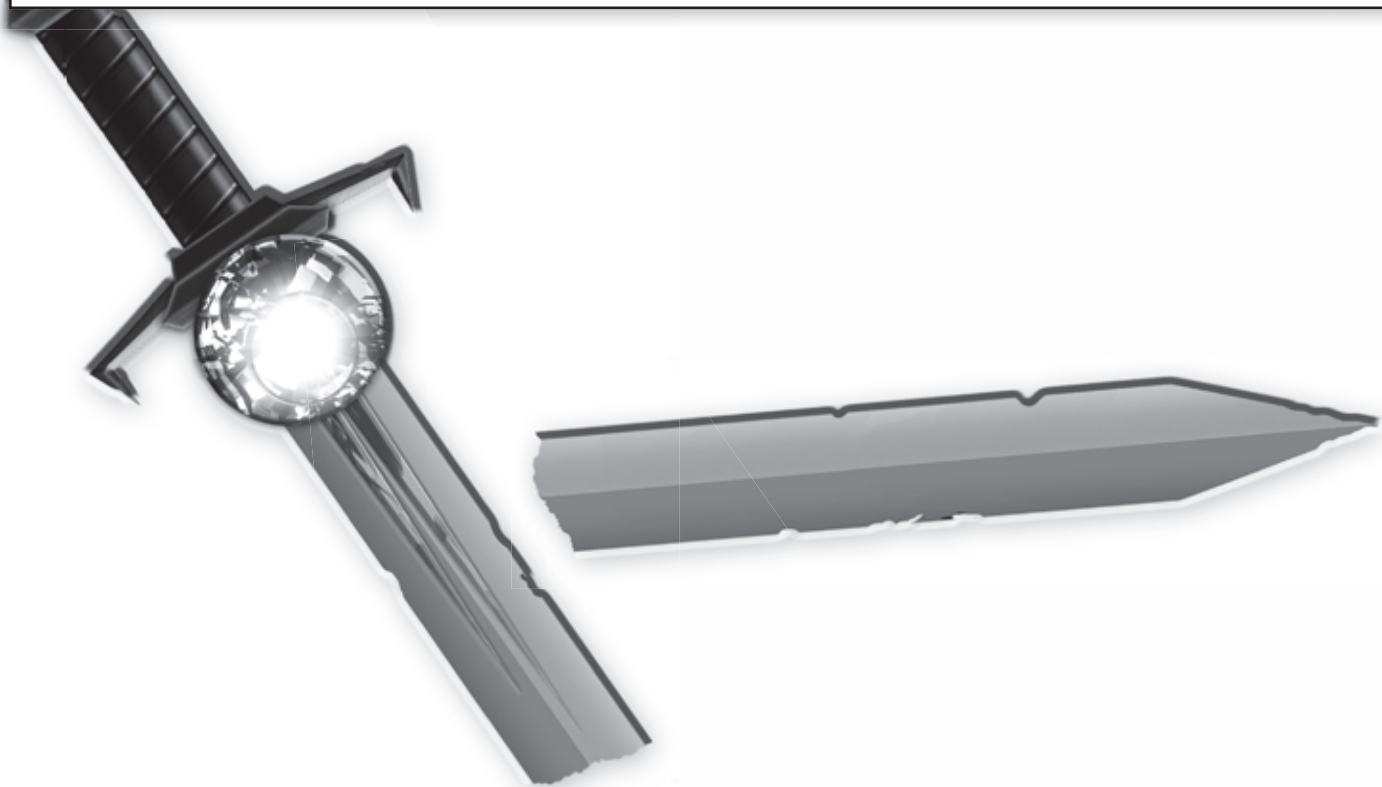

## INTRODUCTION



Welcome to our INN special report, "State of the Sphere: 3078". I'm your host, Bertram Habeas, and I welcome you to this truly historic retrospective.

It has been just over ten years since the start of the war we now know of as the Word of Blake Jihad, a war that has raged across the entire Inner Sphere, leaving no realm untouched. With death and devastation not seen since the days of the early Succession Wars, billions have died, worlds have fallen to ruin, and entire realms have teetered on the brink of collapse. For many, it has become nearly impossible to see a ray of hope, as the skies darken from the smoke and ash of war, yet heroes have risen—and united at last—to turn the tide against the jihadists. Covering these events across the Inner Sphere, INN continues in its commitment to offer its readers and viewers bi-annual reports to record and examine the war as it happens, so that we may all see the bigger picture unfolding before us.

Presented here is a summary of events since our last special report. As ever, we have striven to accumulate data from a variety of sources—most through partnerships and unprecedented access within several organizations—to provide the widest possible view in the most personal and understandable ways. All of this is presented with a minimum of heavy analysis, so that you, the viewer, can make your own judgments. Yet as ever, through these snippets, we hope to show the complex and common fabric that runs through this terrible conflict that has impacted all of humanity like never before.

As a special consideration, this compilation also includes a new and updated review of Terra itself, humanity's home and the inevitable heart of the Jihad. Newly liberated by the allied coalition, it seems only prudent that our viewers receive this opportunity to understand the complex nature of the worlds mankind once called home, long before we stepped out among the stars and brought our wars to the interstellar stage.

All information presented tonight can be accessed through the downloaded media package to all personal data pads, tri-vid systems, and other media devices. When possible, we have included actual video and audio footage, as well as transcripts and copies of written documentation.

As ever, INN thanks you, our loyal viewers, for your patronage and support.

—**Bertram Habeas**, INN Special Correspondent, Terra, 19 January 3079

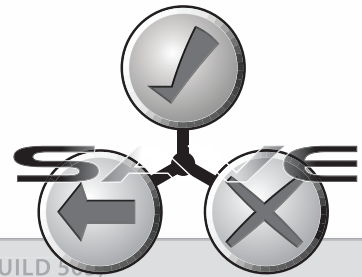

.20

System Scan Initializing

SECURITY LEVEL AMBER



## HOW TO USE THIS BOOK

*Jihad: Terra (JHS: Terra)* is a sourcebook for *BattleTech* that continues where *Blake Ascending*, *Jihad Hot Spots: 3072*, *The Blake Documents*, and *Jihad Hot Spots: 3076* left off, providing players and gamemasters with an ongoing first-hand look at the events of the Word of Blake Jihad that began the closing months of 3068 through the end of 3078. To best reflect the ongoing uncertainty of this period, the material presented in this sourcebook—as with the previous and subsequent *Jihad Hot Spots* books—uses the format of compiled news articles, interviews and first-person accounts. In addition, as the truth of events comes to light, this book and its successors will include a timeline describing those events known to be true from previous books while also providing additional campaign scenarios and new game rules and units based on developments in the appropriate time period.

Beginning with *The Protectorate Crumbles*, *Jihad: Terra* reviews the events that led up to and through *Jihad Hot Spots: 3076*. A review of known events—removed enough from the immediate chaos to be considered fact by nearly everyone in the *BattleTech* universe—is also provided here.

The following sections take readers forward from 3076 through the end of 3078, using the same format as *JHS: 3076*, but with a chronological order and a focus on the allied efforts to shatter the Word of Blake Protectorate and its last holdouts on Terra. Each of these sections includes scenario tracks (called *Chaos Eternal*) compatible with the *Chaos Unbound* and *Chaos Unleashed* campaign systems outlined in *Blake Ascending* and the *Chaos Rampant* and *Chaos Overwhelming* tracks featured in *JHS: 3072* and *JHS: 3076* (respectively). These tracks are also compatible with those found in the *Jihad Turning Points* PDF-exclusive books available through [battlecorps.com](http://battlecorps.com). Gamemasters and players can use these campaign scenarios, which follow the *Chaos Unbound* system, for any number of one-off games. We chose not to reprint the campaign system in this book (which originally appeared in *Dawn of the Jihad/Blake Ascending*, pp. 133-138) so as to provide more room for articles and “hard” rules later on. The *Aftermath* chapter represents the final sourcebook section covering the Jihad in this book, and wraps up events

through 3078, including a few key happenings between early 3077 and the end of 3078. Following *Aftermath* is a special mini-sourcebook, *Touring Terra*, which describes the history, people, and speculations on Terra itself, the birthplace of humanity, once-capital of the Star League, and home to both ComStar and the Word of Blake.

The final section, *Jihad: Terra Rules Annex*, highlights new special rules and spotlights a few new units for advanced *BattleTech* game play whose introductions and/or use played a major role in the events preceding and featured within this book.

### ABOUT THE CHAOS ETERNAL CAMPAIGN

The campaign tracks presented here follow the same rules as originally presented in *Dawn of the Jihad (DotJ)/Blake Ascending*. A free electronic version of this—*Chaos Campaign*—is also available on [www.battlecorps.com](http://www.battlecorps.com). Players and gamemasters will also find these rulebooks handy, depending on the type of campaign run: *Total Warfare (TW)*, *TechManual (TM)*, *Tactical Operations (TO)*, *Strategic Operations (SO)*, *A Time of War (AToW)*, and *Merc Supplemental: Updates (MSU)*. References made to aerospace units in the Tracks will refer to those aerospace unit types featured in *Total Warfare* (such as fighters and DropShips) or those covered in *Strategic Operations* (such as JumpShips, space stations, and WarShips). Additional cited sources may include *Jihad Hot Spots: 3072 (JHS72)*, *Jihad Hot Spots: 3076 (JHS76)*, *Technical Readout: 3075 (TR3075)*, and *Technical Readout: Vehicle Annex (TRVA)*.

If a track does not specify certain parameters, the gamemaster decides what is fair for his or her particular player group. The overall intent of this campaign is to present gamemasters with a framework that allows them to bring their players through the massive conflagration known as the Word of Blake Jihad. Gamemasters begin this arc of the Chaos campaign with *Watershed*. Player groups begin this campaign arc with 1,000 Warchest points or whatever they had remaining at the end of the *Chaos Overwhelming* campaign from *Hot Spots: 3076 (JHS76)*.



THE PROTECTORATE CRUMBLES





## THE PROTECTORATE CRUMBLES

Devlin:

As you requested, I've done a comprehensive review of the last two years. Professor Habeas was most helpful in his assistance in compiling and assimilating all the data; his work with these ComStar specials have been top notch and his data analysis skills are, quite frankly, astonishing. I would recommend you try to convince him to work with Marcel and our intel services.

The last two years have been brutal, but I believe the Word is starting to break down. Aside from the apparent "fault lines" we're seeing across a few of their power blocs, the Protectorate itself is slowly withering from within. The question isn't necessarily if we—and I use this in the collective sense, considering this Coalition we're still firming up—can break them, but if the Houses themselves can survive what crucible that may entail. There is tremendous stresses being brought to bear on all of these realms and it's going to be a tricky thing keeping them from fracturing just when we need them the most.

Take the Federated Suns, for example. Their protracted war against a highly aggressive Concordat is taking its toll, especially from the loose reigns the AFFS gave to Hansen's Roughriders. The Taurians are excessively pissed and don't "resort" to using nuclear weapons, but are now opening up with them. The tremendous tragedy on Brusett is, sadly, becoming typical of the war doctrine being unleashed by the Concordat, invoked solely on making the mercenaries pay for their alleged crimes. While the FedSuns did hold in the end, the public relations nightmare that has blossomed from the incidents along the Periphery border has only fueled the determination of the breakaway Filtvelt Coalition and the copycat Malagrotta region.

Tancred and Yvonne's glossing of the conflict in their rallying speeches in early 3075 hasn't done them any favors along the border worlds. I don't need secret intel to tell me that the March Lords are becoming increasingly resistant to orders and proclamations from New Avalon; Yvonne's speeches make good sound bites, but the farther you move from the Suns' battered capital, the less well-received they become. I give a lot of credit to Tancred for keeping the Draconis March forces from streaming wholesale through the Combine's weak border; it's too bad that Hasek never had such political acumen or maybe Sun Tzu would be a bit more...receptive to our pleas for assistance.

Speaking of the Confederation, our diplomatic efforts remain thwarted with its hard-line ruler. Diplomat Murikami has made no inroads with anyone on Sian, which speaks more to the Capellan's stubbornness and less to their pragmatism. How that realm manages to survive with nearly a third of its worlds under HPG blackout is beyond me; while dragging Blakists out of their protective compounds and shooting them in the streets can be commended in some macabre way, the reality is much harsher. With no operators—or, in some cases, operators now interdicting

their planetary charges simply out of fear—the worlds are ripe for confusion and conquest. They are fortunate the Word has too many problems of its own to take advantage of their crippled state of communications.

What is concerning to myself and others in the Circle is the callousness the CapCon has towards the Protectorate worlds it's taken. The debacles on Wei, Menkar and Pleione are troubling, Devlin. Nearly a million dead combined, at least five cities razed to the ground, and billions upon billions of C-bills in infrastructure destroyed all in the name of *Xin Sheng*? Where is the compassion for their conquered foe? I do wonder if the Confederation holds, at its core, the same principles as the Word, just draped in Chinese robes and "state speeches."

Not that Liao hasn't done his share of diplomatic relations. Naomi's whirlwind Periphery and border tour in 3075 came out a qualified success, even with the attempts on her life. While there's been no outright alliance forged between the Anduriens and the Confederation, you can pretty much gather between the lines that it's a tacit cooperation for the time being.

Andurien's friendliness to the CapCon over its fellow League realms is a testimony to just how bad the League has well and truly gotten. I wouldn't count the Stewart-Marik Commonality as anything more than a broken shell of League power, especially with Paul Marik and his daughter still ruling the roost. Kirc and his Regulans remain fixated on giving the Word a bloody enema despite the fact they're really in no shape to do so. I have heard reports from a few sources that Kirc has something shadowy in the works; I have Marcel looking into what these "Tiger Hill" references might pertain to. Considering the Regulans' continued antagonistic paranoia, I know it's nothing good. And the continued rift with his son, Titus, does the Principality no good favors.

Oriente and many of the smaller power blocks and alliances seem to have been moving slowly towards supporting you. Alys has been instrumental in this; she's been clamoring for another face-to-face meeting with you, by the way. I strongly recommend you let me assign her as a task force commander for SCOUR. I think the key in turning many of the independent League worlds along the border to our side—even just tacitly—is going to rely heavily on her assistance.

Fortunately, we won't need that type of PR from Adam Steiner. The Alliance, for all its internal political problems—David's positive this whole Archonette policy is going to haunt Adam for a long, long time—they've been extremely supportive of the Coalition. I'm pleased that Robert has put aside his blue-blood Skye leanings for the time being; when he's not pontificating, the man has a surprising grasp of tactics and operations. He actually seems somewhat relieved to leave the whole court scene behind for the time being. I was quite impressed with his breakdown of the Galatean liberation, actually. I'd recommend you read it, as he even spots a few flaws

## THE PROTECTORATE CRUMBLES

in your own plans and had some great alternatives that may have resolved that conflict before the turn of the year.

Fortunately, Adam has allowed Robert to throw the entirety of the Skye Province into assisting SCOUR. It's good to have a solid supply source for the operation, something that has had me concerned for a while. With the League in shambles, the Confederation non-existent, the Suns in disarray, it was coming down to either the Combine or the Alliance. Frankly, the situation with the Combine scares me.

With much of their military infrastructure on tenuous threads, a conspiracy being uprooted at the most bloody level, and the leadership in questionable position, the Combine doesn't give me much hope except through the dedication of their troops. The fanatical bureaucracy has squagmired critical parts of its industrial arm, and units aren't seeing parts and equipment for damaged forces. (I've had to augment several of the Dragon's "volunteered" regiments with equipment from other resources, something Minamoto has been rather...vocal about of late.)

But we cannot discount their dedication to eradicating the Blakist threat. Their capture of Al Na'ir, Kessel, and Alnasi this past summer was stunning despite the fact they were outnumbered and hammered with NBC weaponry. I've heard persistent rumors that the ISF has been "leaking" information tying the Black Dragon movement to the Blakists, despite the fact that even Marcel can't find any evidence of such linkage. The ploy seems to have worked; we now have a very rabid and fanatical troop base that I've placed among all of our task forces.

Which brings me to the Dominion.

Devlin, whatever deal you struck with the Ghost Bears...well, I think you spoke to the Devil himself. They have been *relentless* in their drive from Dominion space, cutting a swath of destruction and shattered worlds from Pesht to Luthien to Dyev. What concerns me most, I think, is the sheer brutality these Clan troops are displaying. Their battlefield doctrine of killing every single Blakist they find—including support and administration staff and civilian dependants—is horrifying; fortunately, the (pardon the pun) draconian press regulations in the Combine has kept much of that from trickling out to the public at large.

Their actions are more brutal than the initial invasion in the '50s. I hope you have a grip on these guys, because honestly, the Circle and I are having a hard time accepting yet more Clanners into our midst, never mind their offers of help. It would behoove you and David to come up with a plan to handle the Clans when we get to Terra and beyond, because I'm not so sure they're not using SCOUR as their own little beachhead into following up with the end of the Tukayyid Treaty.

We're entering into probably the greatest point of history since Kerensky invaded the Hegemony. Somehow, we've managed to pull together a fragile Coalition to face down one of mankind's deadliest enemies since the Clans...and I hope like crazy you know what the fuck you're doing.

-Belle

## TIMELINE OF THE JIHAD

## JAN. 3075 TO DEC. 3076

The following timeline summarizes the major confirmed details covered by our last Jihad overview publication (*Jihad Hot Spots: 3076*). For a more complete and contiguous timeline of events throughout the war, please check out our INN "Chronology of the Jihad" net-site.

## 3075

**(8 January)** Taurian forces launch invasions against Robsart, Horsham, and Brussett. Robsart and Horsham fall quickly, but on Brussett, the newly-formed Fourth Taurian Lancers encounter elements of the Hansen's Roughriders. Despite employing nuclear weapons against the planetary capital and primary spaceport, the Fourth fails to destroy the Roughriders, and are destroyed instead by a Roughriders ambush.

**(10 January)** Princess-Regent Yvonne Steiner-Davion and Tancred Sandoval-Davion return to New Avalon, re-establishing central

authority on the FedSuns capital with a public display and a tour of the wreckage of Avalon City.

**(27 January)** The Word of Blake's 50th Shadow Division raids Aur, shattering the Edasich Motors facilities.

**(30 January)** As suddenly as they arrived, the Ghost Bear forces on Luthien and Pesht depart from both Combine worlds, even as the nearest available DCMS commands scramble to fortify them.

**(6 February)** The Lyran Alliance formally places the Odessa system under "quarantine" due to extensive plague outbreaks that began nearly a year earlier.

**(10 February)** Taurian forces invade and capture Mendham. At the same time, AFFS and FedSuns militia forces, backed up by the Hansen's Roughriders, strike at Lothair, Warren, and Hyalite. Though the Taurians hold Lothair, Warren becomes a stalemate. On Hyalite, the Roughriders' use of fuel-air explosives quickly shatters the defending

Gordon's Armored Cavalry, and allows the FedSuns to reclaim that world.

**(11 February)** Magestrix Naomi Centrella-Liao departs Sian, bound for Canopus.

**(14 February)** DCMS troops finally begin to arrive on the war ravaged worlds of Luthien and Pesht, finding no sign of Blakist troop presence in the wake of the Ghost Bear withdrawal. Also on this date, the Word of Blake's 22nd Division raids Wrentham.

**(17 February)** Lindon Ashley's Democracy Now movement stages uprisings while its "Democratic People's Army" raids the neighboring worlds of Akfata and Vermezzo. On Akfata, anarchy reigns after the ruling family flees the DPA assault. On Vermezzo, most of the three highest-ranking noble families (and their supporting government staff) are either killed or taken hostage by DN agitators.

**(21 February)** A FedSuns entourage journeys to the Outworlds Alliance to negotiate a settlement with the Snow Ravens, including





## THE PROTECTORATE

**Xxatch:LAAF.AFFS.CCAF.DCMS.GBD.  
FWLM.readiness.vid.xpss231**

**CIVIL INSURRECTION**

(11 October 3076)

New Syrtis [NSBS] — Down with the Federated Suns! If anything has become abundantly clear as our world burns, it is the utter futility and pointlessness of this seven-fold cursed alliance. It is obsolete yet virulent, much like the black plague. Proper hygiene practices would rid us of the taint.

This message may confuse you as it's the Taurian inbreeds who doing the actual bombing and killing. Make no mistake: these devolved and retarded critters deserve nothing but total annihilation. But consider that we've kicked their malformed asses for centuries now. Dozens of our worlds used to be Taurian. They've *never* been able to get any of them back. Even now, with so many other things pulling on our resources and strength, they're unable to accomplish anything of note.

And that's the problem: when the weakest of all possible foes, barely more organized and competent than a pirate band, manages to bomb New Syrtis *unopposed*, it had better damn well be a wakeup call!

Our mistake was not taking a lesson from the Civil War. The Federated Suns died there, and the ruling line of the Davions died as well. We just didn't notice. Right after it, our first act should have been to go independent, much like the bumpkins from Filtvelt did. Not ten years ago, our military was second to none

## ARBORIS: A WORLD IN CRISIS

(25 November 3076)

TERRA [VOT] – Once again, the peace of Blake has been shattered on yet another tranquil world by those who would sow chaos and discord to serve their own twisted purposes.

On 19 November, during the New Independence Day celebrations on Arboris—normally a day for revelry and joy among the entire Protectorate—Capellan terrorists detonated a “dirty bomb” along the city's main parade route. Hundreds of spectators were killed or wounded, along with several prominent cabinet members and the very popular and beautiful Precentor Sienna Asuncion, a former folk singer beloved by the people for her kindness and frequent acts of beneficence. To add insult to grievous injury, the nearby, “Super Adventure Go!” amusement park was heavily contaminated by radioactive dust scattered by the blasts—poisoned mere hours after the park had opened for the festivities.

Following this heinous act, the terrorists, identified only as The Black Band, demanded the complete dissolution of the planetary government, the surrender of all peaceful Protectorate forces, and the reestablishment of direct rule by their Capellan Confederation masters within twenty-four hours. When their unjust demands were not immediately met, they set off an infinitely more powerful blast in the crowded shopping district on market day. Thousands more were killed, including fifty schoolchildren in a nearby day care that collapsed from the shockwave. Since the terrible attacks, hundreds more have died and continue to suffer from radiation poisoning visited upon innocents by would-be “liberators”. Rather than cower before the demands of terrorists, Arboreans everywhere have taken to the streets, demanding public executions for anyone associated with the Black Band or any other terror cell.

Regrettably, martial law is now in effect planet-wide, but with the wisdom and guidance of the Blessed Blake, the terrorists *will* be brought to justice.

## TIMELINE OF THE JIHAD



the release of captured elements of the Third Crucis Lancers and Snow Raven aid in Devlin Stone's coalition. The Ravens assure the FedSuns that they will not strike again without provocation, but claim the captured Lancers as isorla of the “Raven Alliance” and refuse to join Stone's coalition.

**(23 February)** As a sign of goodwill, Yvonne Steiner-Davion gifts the captured Word of Blake vessel *Dark Light* (now rechristened the *FSS Excalibur*) to Devlin Stone.

**(4 March)** Pro-Democracy Now agitators bomb the Capital Arcology Complex on Ferihegy, killing over five thousand Ferihegy residents and producing a massive public backlash against the Democracy Now leader and his followers throughout the Kaumberg Archonette.

**(17 March)** Cybernetically-augmented forces from the Circinus Federation assault

and conquer Khon Kaen and Poulso. Additional Federation troops attack the Marian Hegemony worlds of Blantleff and Maximilian.

**(21 March)** During a raid against the Isesaki Shipping headquarters on Isesaki, the Word of Blake's infamous Opacus Venatori kill Viscount Ernest Machida and level a wide swath of the Ukonosi City commercial district, including the Isesaki Shipping headquarters building itself.

**(2 April)** Rayanne Nellis is elected Director of the Niops Association's ruling government after a hotly contested three-month campaign.

**(5 April)** Taurian forces attack and seize Wrentham, capitalizing on the damage inflicted by the Word of Blake raid there in February.

**(11 April)** As public outcry mounts over the increasingly radical actions of Lindon

Ashley and his Democracy Now agitators, Kaumberg Archonette forces launch a two-pronged assault on Akfata and Vermezzo.

**(13 April)** Citing no confidence in the League's central government, the Rim Commonality formally bars all high-ranking Free Worlds representatives and invokes Camlann vs. Free Worlds, essentially breaking away from the Free Worlds League.

**(15 April)** Hansen's Roughriders attack Amber Grove in Taurian space. Using a combination of nuclear and non-nuclear weapons secured from their victory on Hyalite, the Roughriders obliterate the central military headquarters, spaceport facilities, and the local militia, then spend the next few weeks smashing any target of significant industrial or military value.

**(17 April)** An unidentified Word of Blake Shadow Division reportedly retakes Gabriel

## THE PROTECTORATE CRUMBLES



within the Suns. So we would then have been in an excellent position to apply the final solution to the Capellan problem, and still have plenty left over to deal with the Taurian scum. Now, we get to wait for a reaction from “high command” instead. We’ll be lucky to see reinforcements this side of ’77!

Let’s examine what the bloated Suns have bought us over the centuries: nothing but increasingly complex and incompetent bureaucracy, a gradual encroaching of Davion laws and agencies in our daily lives, and our sons and daughters dying in wars and on worlds we do not—*should not*—care about.

Every moment we delay in separating our March from the Federated Suns is a moment we are bled further, and have no one to rely on for defense. While the transition will be costly, it is also the only path to true independence. And once free of our burden, our first objective must be to destroy the Taurians once and for all! They are so eager to expend nuclear weaponry, let us depopulate their worlds in repayment of their sins!

**SIGNS OF THINGS TO COME?**

(3 December 3076)

Ascella [DRAKE] — To many, the campaign on Ascella appeared to be one among several. The Ghost Bears spared no Blakists, and the Blakists spared nothing within their arsenal to resist the Clanners. Given the horrors that were inflicted upon our brethren in the wake of Blakist nuclear weaponry, many find reason to celebrate the Clan’s treatment of the Blakist foe during the thirteen-day campaign.

But recently, the denizens of the “armpit” have become increasingly aware of an unusual fact: the relative pristine condition of the capital, Copiosus.

Stone’s Lament gradually worked their way through various Word strong points around the city. On the fifth day of their attack, they accepted the surrender of a large number of the surviving Blakists defenders, including the majority of their on-site leadership, at the HPG compound. The holdouts were dispatched swiftly during the course of the sixth day.

What is even more notable is the Ghost Bear’s arrival. They arrived in a formation as if ready to assault Copiosus. Why would such maneuvers be necessary when approaching a town held by allies?

The only logical explanation: they were unaware that Stone’s forces had secured the capital. Can that be explained as miscommunication? Perhaps. But examine the act: Stone’s Lament had managed to capture the planet’s most heavily defended city, and without suffering the casualties or collateral damage that are the hallmark of Ghost Bear assaults. By all accounts, especially by the standards of waste-averse Clanners, his victory was superior to all Bear accomplishments. And it was presented to the Bears like a slap in the face. That this antagonized the Bears is without doubt: they left Ascella as swiftly as possible.

Why would Stone deliberately offend his most powerful, and most tenuous allies?

Was Copiosus intended as a lesson of sorts for the Bears? Was it intended to prove his superiority?

Whatever the true reason, one can hope that the Bears will repeat Stone’s style of conquest elsewhere.

**BIG DOINGS ON LITTLE BIG HORN**

(3 December 3076)

Donegal [DONEGAL SPECTATOR] – Late last night, the General

## TIMELINE OF THE JIHAD



in the Odessa system, backed up by an *Essex*-class destroyer and a *Black Lion*-class battlecruiser.

**(25 April)** Naomi Centrella-Liao visits Andurien as an envoy of both the Capellan Confederation and the Magistracy of Canopus. During the tense visit, the Magestrix reminds the Anduriens of the shared history of Canopus, Andurien, and House Liao, and pointedly warns Andurien against pursuing “ambitions of the past”.

**(30 April)** As part of an effort to reinforce the fragmenting Periphery front, the AFFS redeploys several Crucis March Militias to areas along the Malagrotta-Filtvelt region.

**(1 May)** Akfata is reclaimed by Kaumberg Planetary Guard forces, but in the fighting to retake Vermezzo, Democracy Now forces resort to scorched earth tactics and taking hostages to stave off their

inevitable defeat. The destruction leaves thousands homeless, dead, or injured. On this same day, Magestrix Naomi Centrella-Liao departs from Andurien, en route to Canopus with a signed non-aggression pact that covers the Capellan, Canopian, and Andurien states.

**(3 May)** The Taurian WarShip *Vendetta* unleashes an orbital attack on Hyalite, aimed at destroying the military facilities and planetary HPG compound that were subverted by the Hansen’s Roughriders.

**(4 May)** Prince Titus Cameron-Jones of Regulus marries Michelle Ryan in a modest ceremony in Regulus City.

**(12 May)** Word of Blake forces raid New Valencia, damaging the GM/Blackwell production lines there, but several of their escaping transports are intercepted and destroyed by AFFS aerospace forces.

**(16 May)** The Kaumberg Archonette hires the Kirkpatrick’s Invaders mercenary command to augment its damaged military. Also on this date, Marshal Photon Marik strikes a deal with the Buena Archonette for a joint mission against the Circinian forces on Poulso and Khon Kaen.

**(18 May)** Lyran and Exiled Wolf WarShips arrive at Odessa to break the Blakist occupation there. The initial battle ends with a standoff.

**(22 May)** Even as the Blakist forces at Gabriel continue to search and plunder their fallen facility, a Ghost Bear attack force arrives from a pirate point nearby and immediately orders the Lyran and Wolf ships to stand down. After crippling one of the Lyran ships which attempts to intervene, the Ghost Bears engage the Blakists, but are unable to prevent them from escaping or scuttling the Gabriel facilities.



## THE PROTECTORATE CRUMBLES

Dynamics cargo port outside Wytheville was the scene of minor bedlam with the arrival of the *Monarch-class Little Big Horn*. The appearance of the rumored command vessel of General Belle Lee has added more fuel to the rumors swirling around the Archonette that the Inner Sphere coalition commander Devlin Stone is making final preparations to invade the Word of Blake Protectorate.

"We got the heads-up about the *Horn's* arrival about fifteen minutes before she roared in," commented GD dock master Adelle Smyth. "Something about security protocols and all that. Tell you this, though: all you merchants looking for shipments coming in better get ready for some delays. They've got this port locked down tight. Ain't no shipping in or out unless it's one of Stone's lot."

The cargo port has been under tight security since the *Horn's* arrival and officials have been tight-lipped as to when normal operations will resume. Currently, shipments are being redirected to the Meridian drop facility, over 1,000 kilometers away.

Despite the lockdown, at least three security convoys have been seen arriving at the facility. One was positively identified as the security group belonging to Duke Robert Kelswa-Steiner, though his detail was lacking the usual Skye Guards escort BattleMech. The identity of the other arrivals has not been confirmed, though speculation is that they are Field Marshall Katherine Sandoval-Ito from the Federated Suns and *Tai-shu* Isoroku Kurita from the Draconis Combine. Both officers and their entourages arrived on Donegal in mid-November and have been secluded in nearby Bladensburg.

Donegal Civilian Space Transit officials have confirmed that there are several other DropShips inbound from recently arrived JumpShips, bringing the total number of vessels at the zenith

point to over seventy. If Stone or General Lee are indeed present on Donegal and receiving military commanders from other realms, then this may well herald the beginnings of the long-awaited invasion of the Protectorate.

## RIGHTEOUS FURY

Why are the Bears so angry? Even now, two years after they entered the war against the Word, we are no closer to an understanding of just why Clan Ghost Bear joined the fight. When questioned, their warriors have always refused to answer. Even their ostensible allies in the struggle have felt their wrath, coming under fire at Luthien, Pesht and Odessa as the Bears savaged Blakist forces with but the tersest of warnings for friendly elements to get out of the way.

Senior INN Clan analyst Farouk O'Reilly sees several reasons behind the Bear fury: "The Ghost Bears have a number of reasons to hate the Word of Blake. First, they assaulted Tukayyid, and thus the Rasalhagian populace that they feel very protective towards. Then, Bjorn Jorgensson, their beloved Khan, was killed in the Arc-Royal bombing of early 3073 and, not too long after, four million souls were murdered on Radstadt. There have even been reports of Blakist involvement in the resistance cell recently discovered on Dehgotan. But most devastating is the elimination of nearly an entire Bloodhouse."

The event O'Reilly refers to is the highly rumored destruction of House Tseng, one of the many Bloodhouses that make up the elite of Clan warrior society. Details remain scarce regarding this tragedy, but rumors persist that only a handful of Tseng warriors survive today, including the Clan's Loremaster, Laurie Tseng.

But how did such a tragedy occur?

## TIMELINE OF THE JIHAD

**(30 May)** The Word of Blake's Twenty-second Militia raids Brusett. The FedSuns mobilizes the WarShip *Kathil* and a small flotilla of supporting vessels to the planet, determined to head off the next Taurian attack.

**(4 June)** Black Dragon Society elements attempt to raid the FedSuns world of Bryceland for supplies, but are thwarted when the Davion commander orders the underground bunkers' demolition charges triggered.

**(6 June)** Unidentified forces (rumored to be Word of Blake Shadow Divisions) reportedly raid the Protectorate worlds of Caph, Epsilon Indi, and New Home simultaneously, damaging Blake Protectorate forces.

**(21 June)** A joint mission between FWLM and LAAF troops strikes at Poulsbo and Khon Kaen. The defending Circinus forces—including a mix of Word of Blake "irregulars"

and Circinian "chain gang" troops—sell themselves dearly against the attackers, indicating that the Word of Blake is raising new Shadow Divisions in Circinus space.

**(30 Jun)** The Taurian WarShip *Vendetta* is met by a Davion naval force led by the *Kathil* and her escorts at Brusett. Both sides employ nuclear weapons above and within the planetary atmosphere. The *Kathil* is destroyed, but the Taurians are forced to retreat, while several major cities on Brusett suffer horrendous collateral damage.

**(18 July)** An eight-kilometer wide asteroid (dubbed SH01378-A) slams into the highly populated Narosi continent on Shinonoi, a Combine world near the Blake Protectorate, creating widespread chaos.

**(20 July)** An insurrection against the Word of Blake on Tikonov finally shatters the Word's control over the planet. Retreating Blakist

forces level over half the Tikonovian factory complexes.

**(21-28 July)** CCAF forces launch attacks against Wei, Menkar, and Pleione. In all three cases, the CCAF employ atomic weapons to crush the Protectorate defenders, leaving tens of thousands dead. Also at this time, the Hansen's Roughriders strike at Perdition, and subvert the Longwood's Bluecoats mercenary command there. Before departing, the Roughriders raze the Perdition factory complexes.

**(1 August)** *Kanrei* Minamoto joins with Devlin Stone in promising aid to the devastated world of Shinonoi, an act that spurs outcry from many Arkab world leaders.

**(3 August)** Magestrix Naomi Centrella-Liao leads a combined Capellan-Canopian force against the surviving elements of the Word of Blake's 34th Militia on Canopus,

## THE PROTECTORATE CRUMBLES

## A TIME OF CLEANSING

(28 December 3076)

Dyev [VotW] – *Breaking News!* The glorious Word of Blake Militia has struck a blow for the cause of peace and justice! Early this December, the Twenty-eighth Division spearheaded a counter-assault on Dyev, augmented by elements of the Thirty-second Division. Supporting our veteran commands were the Third Bryant, First Lipton, Second New Earth, and the First Zosma Protectorate Militia Divisions.

This pre-planned assault came as on-world Militia forces held the abominations of Clan Ghost Bear in a delaying tactic. Catching the unholy children of Kerensky unaware, attacking Militia forces braved the gauntlet of Snow Raven and Ghost Bear WarShips to make planetfall. Though our losses were painful, casualties still ran less than expected.

Our brave forces successfully landed near the capital city of Novaya Mensk and at Trogport, where they stabilized the lines. Making excellent use of terrain, the Twenty-eighth, Bryant, and Lipton commands moved through the Tupik Chasm and massive mining tunnel network. The Bears' Alpha and Omega Galaxies were hard pressed to remove our illustrious forces from these natural defenses. Meanwhile, in the south, our Thirty-second Division, augmented by the New Earth and Zosma Divisions took the massive fortifications provided by the Combine before they ceded Dyev to us as caretakers. Although the Bears' Kappa and Pi Galaxies bitterly contest our positions, their efforts are futile. Losses are expected, but the Clansmen will bear the brunt of our holy fire.

In the north, our men and women face a determined enemy. These bloodthirsty Ghost Bears assault our lines with reckless abandon, paying the price in blood to destroy what they cannot hope to defeat. And yet, our Master assures that Blake's sword will sunder the heads of our enemies, freeing Dyev once more from the corruption of Kerensky's misbegotten kin.

New claims from a former ROM operative may shed some light on this question. Speaking under promise of anonymity, a source we will refer to only as "Whistler" alleged that during the original Clan invasion, ComStar was heavily involved in developing biological weapons to be used in the event that the Clans threatened Terra itself. According to this source, one of the projects under this aegis investigated the deliberate targeting of specific Clan genetic heritages. Could the schismatics have taken this research with them when the Word of Blake was formed? We now believe their plan was to attack the Clan Homeworlds; could one such assault—backed up by horrific biological weaponry—be what has ignited the Bears' fury?

—Excerpt from INN news magazine show *A Time of War*, 12 December 3076

## AFFS RECLAIMS THREE WORLDS

(29 December 3076)

Tikonov [FSNS] — My father was a war correspondent in the 3028 war. Assigned as an embedded reporter in the Crucis Lancers, he witnessed the Federated Suns' liberation of Tikonov first hand. I can still recall his stories of that war. One theme that came up time and again, was the lengths the AFFS went to minimize collateral damage.

Nearly fifty years later, it is a continuing tradition that I am proud to report on. Despite the Word of Blake's unrestrained war—or perhaps precisely because of it—the men and women of the Federated Suns have tackled the liberation of the former Chaos March with a sense

## TIMELINE OF THE JIHAD

reclaiming the capital world after a brief, but bitter struggle.

**(14-28 August)** Ghost Bear forces advance through Combine space, ignoring all hails. Their first strikes land on the Blakist-held worlds of Cebalrai, Vega, Eltanin, Alya. A second wave hits Kaus Borealis.

**(20 August)** During their desperate defense of Cebalrai, the Blakist forces there resort to detonating a large neutron weapon that wipes out the Seventh Bear Regulars and the Sixty-ninth PGC, the Blakist defenders themselves, and thousands of civilians.

**(24 August)** Mercenary-supported forces from the Kaumberg Archonette assault Virtue in force. The DPA defenders surrender after a two-week siege and Lindon Ashley is taken prisoner.

**(1 September)** On Baranda, the Remagen CrMM—commanded by Major General

Raymond-Roger Marsin—soundly defeats a pirate incursion coming from the Malagrotta region.

**(5 September)** Magestrix Naomi Centrella-Liao formally returns to the remains of Crimson in a symbolic reinstatement of her birthright.

**(7 September)** The first aid ships arrive at Shinonoi to assist at local crisis centers. Also at this time, the Hansen's Roughriders' attack Grossbach.

**(14 September)** Devlin Stone leads a small diplomatic force to meet with the Ghost Bear troops on Kaus Borealis.

**(21 September)** The Ghost Bears agree to assist Devlin Stone's growing allied coalition.

**(23 September)** Unknown raiders (once more rumored to be Shadow Divisions) attack the WoBM and Protectorate Militia forces on Castor, Graham IV, and Pollux.

**(6 October)** Ghost Bears forces hit Kaus

Media, Kaus Australis, and Ascella. At Ascella, Word of Blake Pocket WarShips destroy half of the Bears' inbound DropShips, stalling their advance.

**(22 October)** After working for the Malagrotta Collective breakaway government for several months under Letters of Marque, the Death's Consorts pirate group undergoes a sudden "change of management", and turns on Malagrotta itself.

**(25 October)** Gary Tiquahme, the new leader of the Death's Consorts, completes his coup on Malagrotta. On the same date, the Remagen CrMM shatters a suspected Consorts pirate base on the world of June.

**(30 October)** Alarmed by the Malagrotta coup, the Filtvelt Coalition orders an increase in its militia and mercenary force deployments to the Malagrotta border region.

## WHO IS GREGORY KELSWA-STEINER?

"Who is this guy?" That's the question that is on many minds. This ducal spawn certainly has much to answer for. But hey; why not check out what the suits have managed to dig up about him? This little bitty managed to make it from someone's inbox to my inbox. Honestly, it's amazing we don't get to read the corps' mail more often.

### >>GM Intel Service: Person-of-interest Review: N-02-091c:GK-S — [DATA DELETED]<<<

Given Gregory Kelswa-Steiner's upbringing, a degree of tactical competence can be expected. Joining the Skye Guards at the early age of 17, comparisons to Nondi Steiner were numerous in Kelswa-Steiner supported news outlets. The years have proven Gregory as tactically competent, though hardly a prodigy. He seems to have benefited from tutelage under Maria Esteban, and promises to be a competent strategist, both at the planetary and interplanetary level. So far, however, there have been limited opportunities to test these assumptions.

His prominence among the Stone Coalition's effort against the Word of Blake is therefore largely the result of his lineage. In the same task force that is led by his father, Robert Kelswa-Steiner, his assignment is intended either to reward Robert for his allegiance, or to ensure his focus on the success of the operation. While Robert might make poor decisions with the other elements of the Lyran Thrust's Group I, he will likely not do so purposefully, as it will impact the life and career of his heir.

Therefore, Gregory is unlikely to become a prominent component of the Lyran effort, given his age and lack of experience—especially with a Wolf Clan saKhan assigned as the Group's XO. Still, as this designates him third in command of the effort, it is wise to hedge one's bets. Gregory will be highly motivated to justify himself as the heir to Robert Kelswa-Steiner (given his illegitimate birth). We should thus make substantial inroads in Skye's industry if we take action to ensure that Gregory regards our company favorably. He has been outspoken in his preference for a more autonomous Skye region, a position which—while predictable—can be helpful.

He is further said to be a man who enjoys his leisure time, with an appreciation for the finer things in life common to the Steiners. While certainly not as extravagant as the late Caesar Steiner once was, opportunities may exist to influence who Gregory spends time with during off-duty hours.

—Nekkar Public Server netpost attributed to "Starling", posted 12 January 3077

of pride and honor. Even after witnessing the horrors that were delivered upon Tikonov and Rio, their determination to not lower to the Word's level has remained strong. This month, coordinated assaults have hit the worlds of Schedar, Caselton and Mirach. Following barely a safe distance behind the AFFS assault forces were DropShips filled with humanitarian relief supplies.

Fighting was particularly brutal on the arid world of Schedar. There, the on-again, off-again hard-luck unit, Wilson's Hussars, finally ran out of cards during a Blakist counterattack. Wiped out to a man, the Hussars still managed to blunt the Word's advance, giving the Second FedSuns Armored Cavalry (formerly the First Cunningham Commandos) time to reach the field and drive the

## TIMELINE OF THE JIHAD

**(2 November)** Allied forces under command of Devlin Stone mount an expedition to liberate Galatea from the Eleventh Word of Blake Militia, but though the landings are initially successful, Blakist resistance continues for some time. At about this same time, a Ghost Bear delegation journeys to the Outworlds Alliance to negotiate for the Snow Ravens to support Stone's coalition.

**(12 November)** A terrorist bomb detonates within the council chambers of the Niops Association Council, killing Director Nellis and Chairperson Tran, along with a third of the other representatives and guests gathered. Chairperson Olsen, critically injured, is hospitalized in a coma. Brigadier L. Jamison Fallon of the NAM declares a state of emergency and dissolves the council, effectively declaring martial law.

**(14 November)** Tiqualmé's Consorts and a host

of other pirates hired out of the Pirate's Haven begin to expand their control throughout the destabilized Malagrotta region.

**(21 November)** Hansen's Roughriders move further into the Taurian Concordat, raiding Sterope and plundering the Sterope Defense Industries factories. Unlike previous attacks, the Roughriders leave the local factories intact.

**(8 December)** Irian's pro-Blakist regime is overthrown after years of bloody—yet largely hidden—resistance. The retreating Blakist forces resort to scorched earth tactics during their final withdrawal, destroying several IrTech facilities with tactical nuclear weapons.

**(15 December)** Magestrix Naomi Centrella-Liao departs from Canopus, bound for Sian. The CCAF's Red Lancers remain behind to bolster planetary defenses.

**(19 December)** Backed by Snow Raven support assets, Clan Ghost Bear resumes its offensive

against the Blakists with an assault on Ascella. Coalition forces led by Devlin Stone arrive at approximately the same time. The Bears battle Blakist forces for two weeks over the primary spaceport and industriplexes, with WoBM forces employing scorched earth tactics the entire time, only to discover that Stone's Lament captured the capital city and HPG compound a week before.

**(21 December)** Tiqualmé's Consorts and their pirate allies aggressively establish occupation posts on the Malagrotta worlds closest to the Filtvelt Coalition in anticipation of an imminent confrontation. Meanwhile, the Remagen and Islamabad CrMMs, bolstered by various smaller conventional forces, have established picket forces on Estuan, Agliana, June, Baranda, and Adelson, effectively surrounding the Malagrotta breakaway state.

## THE PROTECTORATE CRUMBLES



Blakist Militia into wholesale retreat. Similar scenes played out on Mirach and Caselton, with the AFFS putting civilians first despite chemical attacks on Caselton and terror tactics on Mirach.

Finally taking the war back to the Word of Blake, the AFFS is achieving victory without lowering itself to the Word's tactics.

### AUTOPSY OF DYEV

(28 January 3077)

Trondheim [NRS] – Ever since the disastrous naval battle against Clan Nova Cat over Alshain in 3067 (an act that cost them large parts of their fleet at the time), the Ghost Bears have reinforced their navy with the heaviest battleships ever seen. It is a fleet that since then has excelled in every conflict it has taken part: Tukayyid, Luthien, Pesht. The Bear WarShips have shrugged off nuclear strikes, taken on all comers, and emerged victorious...

Except at Dyev, where the Blakists finally managed to kill a WarShip, a powerful *Aegis* cruiser. What went wrong that allowed a third of the Bears' task force to be lost against a clearly inferior force?

On paper it was a clear-cut fight: a *Leviathan*, *Aegis* and *Nightlord* against a *Whirlwind*, *Aegis* and *Congress*. The *Leviathan* alone should have been able to take out all three vessels in quick succession. While the true details are, as usual, restricted from the public, we can only assume that naval integrity of the powerful Clan isn't as stellar as it should be.

Or have the Ghost Bears become complacent through their victories so far? They clearly feel that the *Leviathans* can take on any opposition and emerge triumphant so their other forces could have let their guard down. Or maybe the enemy finally figured that it would be far smarter to gun for other ships first. A

*Leviathan* is powerful, but with only three of them, they cannot be everywhere at once. Strip these behemoths of their escorts and you limit the Bear's naval options. This is what the Blakists did at Dyev, tying down the main force with their own WarShips; the Word sent reinforcements through the back door. Only time will tell if the Bears are capable of learning from their mistakes.

### HORRORS IN THE FUNHOUSE

(6 January 3077)

Brusset [TAURUS CLARION] — Today the fires continue to spread to the southern part of the industrial sector of Brisborough, forcing the evacuation of another ten thousand civilians to its sister city of Cardow. This marks two weeks of constant flames since the defending Taurian partisans detonated a nuclear demolition charge within the industrial sector, hoping to trap and destroy the advancing Davion hordes.

Scenes such as this have begun to play out all across Brusset. As FedSuns troops push to capture positions and high value targets, withdrawing partisans are laying and triggering booby traps, many of which contain low-yield nuclear charges. The resulting destruction has not only inflicted heavy casualties on the enemy troops within the blast range, but has also leveled many of the urban and industrial territories being fought over, leaving naught but "scorched earth" behind.

Cornet David Wilson, commander of one of the Brusset partisan forces, justified these tactics: "Those Davion bastards have been raping Brusset for centuries. Even if we are pushed off again for another century, we'll make sure not only that will they pay a hefty price taking it, but that they won't be able to continue to use it if we have to leave again."

## TIMELINE OF THE JIHAD



3076

**(14 January)** In connection with the November bombing of the Association Council, Captain Alicia Carmichael of the NAM is arrested and charged with treason against the Niops Association.

**(20 January)** Stone's allied coalition finally ousts the last of the Word's Eleventh Division from Galatea.

**(21 January)** The Kaumberg Archonette puts Lindon Ashley and a handful of his key lieutenants on trial for crimes against the Kaumberg Archonette and the Lyrans Alliance.

**(28 January)** Reputed elements of the Black Heart Roses mercenary command break Captain Carmichael out of prison on Niops, sparking a battle between NAM forces and the Roses.

**(7 February)** A Blakist strike force attempting to attack Magestrix Centrella-Liao's

JumpShip is repelled by Andurien fighters at Furud.

**(11 February)** A Taurian raid on Panpour critically damages the Jalastar Mech production lines.

**(16 February)** Clan Snow Raven dispatches two naval Stars to join Devlin Stone's allied coalition, escorting the Ghost Bear delegation led by Aletha Kabrinski.

**(17 February)** Devlin Stone and his allies reported begin drawing up plans for a concerted coalition invasion of the Blake Protectorate. Also on this date, the Kaumberg Archonette finds Lindon Ashley and his lieutenants guilty of multiple crimes against the state and its people, and sentences all to death.

**(20 February)** Clan Diamond Shark offers its Clan's transport services to Devlin Stone's coalition.

**(26 February)** Lindon Ashley and five of his top lieutenants in the Democracy Now movement are executed by firing squad on Kaumberg.

**(27 February)** A rogue force (reportedly of ComStar origins) attacks Campbelton, targeting the Word of Blake's Twentieth Division there. During the battle, the attackers unleash several tactical nuclear weapons against the Blakist forces, incidentally destroying three major population centers where Twentieth Division forces are arrayed in defense, costing close to two million lives in total from the initial attack and the fallout. Also on this date, the fighting between the NAM and the Black Heart Roses ends, with the battered mercenaries exiled from the Association. As the Roses depart, a mysterious explosion holes their DropShip, leaving no apparent survivors.

## CRACKS IN THE FAÇADE

**HPG Feed Results:  
“Lyons/Garrison/Violence”  
(12 December 3076)**

Lyons [SBC] – The simmering powder keg finally blew up early this morning when advanced forces from the Seventh Donegal Guards struck the fortified base camp of the Sixth Pesht Regulars. A quick air strike followed by an airborne infantry assault seized the facility within the hour, giving the Lyrans claim to first blood in the continuing tensions surrounding Lyons’ fate.

It’s unknown what exactly the DCMS forces did to provoke the Lyran response; the bulk of the DCMS has been carrying out war game strategy sessions on the Alterland continent. All DCMS bases have since been placed on high alert.

**(13 December 3076)**

Lyons [SBC] – DCMS forces captured the Federated-Boeing International DropPort after an intense ground battle, seizing it and grounding all flights. Casualties on both sides are unknown.

“Since the Alliance has deemed it necessary to violate its orders, we have no choice but to defend ourselves,” said *Chusa Rolfando* in a statement.

More skirmishes have been reported over the last few hours as Alliance and

Combine forces clash. “We’re trying to get as many people out of the line of fire as possible,” said Ernestine Chieri, aide to Governor Michael Bloomsworth. “We’ve already sent several requests to the Coalition Command to help resolve the situation. These garrison forces should be helping us rebuild from the Blakist occupation, not adding to our misery and destruction.”

**(20 December 3076)**

Lyons [SBC] – Governor Bloomsworth has announced that a negotiation team from Devlin Stone’s Coalition Command is en route to assist in defusing the escalating violence between Lyran and Combine forces. “We have been informed that a special task force headed by General Belle Lee will be here within fourteen days,” said the governor’s office in a prepared statement. “It is unfortunate that these two units cannot put aside their grievances but we remain confident that General Lee will bring about a successful resolution upon her arrival.”

Neither the Seventh Donegal Guards nor the Sixth Pesht Regulars commanders were available for comment.

**(5 January 3077)**

Lyons [SBC] – After a series of stunning

successes, General Belle Lee has halted all combat between the Lyran and Combine garrison forces originally assigned to help rebuild Lyons.

“The Coalition is saddened and angered that two of its assigned units has decided to follow the path of factionalism, rather than bonding in an act of solidarity,” commented General Lee during a brief press conference last night. “Rest assured, the responsible parties will be punished and actions taken to make sure incidents like this do not occur again here on Lyons or elsewhere.

“As of today, both the Seventh Donegal Guards and Sixth Pesht Regulars are removed from garrison posting and being sent back to their respective militaries. I have assigned the Thirty-First Battalion of the Com Guard Sixth Army to remain here as a garrison force, under the command authorization of Governor Bloomsworth. Their primary operational goal is to aid and assist in the rebuilding efforts on Lyons and execute a full defense of the planet against hostile forces, as deemed by the Governor.

“Devlin Stone has asked me to send along his personal apologies for the failure of these units and he will, when he can, try to make things right after the Blakist threat is destroyed.”

## TIMELINE OF THE JIHAD

**(1-25 March)** Stragglers from Clan Ice Hellion reportedly raid the Periphery edge of the Ghost Bear Dominion, hitting Holmsbu, Constance, and Pinnacle, before Rasalhague KungsArmé forces manage to pin them down on Damian.

**(7 March)** The Remagen CrMM attacks and seizes the pirate-held world of Gronholt, shattering two companies’ worth of Death’s Consorts and allied pirates. The surviving elements of these units retreat to Great Gorge, leaving Gronholt in FedSuns hands.

**(10 March)** The Mosiro Archipelago signs a defense pact with the Duchy of Andurien. The Third Andurien Rangers take up station on all three worlds of the tiny substate.

**(17 March)** A detachment from the Forty-ninth Shadow Division assaults Harmony. The attack employs nuclear weapons against a Regular facility of unknown nature.

**(25 March)** Allied scouts raid Rochelle, Kaus Borealis, Rio, and Halloran V.

**(30 March)** The Word of Blake’s Fiftieth Shadow Division, led by Precentor Manei Domini Apollyon, arrives at Regulus under a flag of truce and issues a warning to Regular prince Titus Cameron-Jones against “military adventurism”. Also on this date, Magestrix Naomi Centrella-Liao successfully returns to Sian under a joint Andurien-Capellan escort.

**(5 April)** Hansen’s Roughriders return to FedSuns space, landing on the recently reclaimed world of Warren for supplies.

**(6 April)** A failed raid, reportedly sponsored by Oriente, against Atrous costs the lives of the Second Knights of the Inner Sphere. Also on this date, Canopian raiders hit Astrokaszy with Capellan material support, targeting suspected WoB bases on planet and engaging elements of the Order of the

Faithful. And, on New Syrtis, a violent protest erupts against the authority of March Lord Angela Hasek, allegedly instigated by Blakist agitators who claim that the FedSuns government, and not the Word of Blake, assassinated George Hasek in 3070.

**(29 April)** After refusing to join Stone’s allied coalition, Chancellor Sun-Tzu Liao and Magestrix Naomi Centrella-Liao state that CCAF and MAF commands will not interfere with any allied efforts to reclaim Capellan worlds.

**(7 May)** Clan Diamond Shark wins a Trial against Ghost Bear forces to establish an enclave on Tukayyid.

**(14 May)** Representatives from Devlin Stone’s resistance meet with General Hampton on New Hessen and receive permission to use the world as a staging base against the Protectorate.

## THE PROTECTORATE CRUMBLES



These extreme tactics have not gone without retaliation. The handful of Suns' "pocket WarShips" in orbit have recently begun bombarding partisan positions before their ground troops advance, regardless of whether or not the partisans are fighting in populated areas. This has only increased the collateral damage across the planet and—in one case just yesterday—preemptively detonated one of the nuclear traps before the partisans could withdraw...

## MORE MERCENARIES FLEEING

(18 April 3077)

Galatea [MERCNET] — I recently had a chance to sit down with the commander of a mercenary unit that was working for the Word of Blake until now, Deliah Finn of Deliah's Gauntlet.

**[Cristen Gardner]:** "Tell us how you came to work for the Blakists and what it was like working with them."

**[Deliah Finn]:** "They were very accepting of our religious beliefs at first and they really helped the people of Capolla. The people were so happy to get some stability. And as employers, they took good care of us, paid us well and on time."

**[Gardner]:** "When did things change?"

**[Finn]:** "Well, around 3072 things got more restrictive. The

brief time of personal freedom the world experienced had raised expectations, but the Word started bringing back the paranoid feeling of the Confederation. By 3075, things were scary. A rumor broke out about WMDs and since the One Star Faithful had radio telescopes and other advanced gear, they got the brunt of the blame. Then it turned to us; we barely made it into the jungle before the Militia hit our base."

**[Gardner]:** "Then you had to fight a guerilla war?"

**[Finn]:** "Against the very militia we'd helped train, yes, though the populace helped us out. We were able to get some repair materials and munitions. Mostly we avoided major engagements. Finally our contacts told us that the Colonel was massing to come get us. He only had about a company, so we decided to take them on. It cost us a lance worth of 'Mechs and a loyal comrade. We took one of their *Unions* and got out of there. I wish we hadn't left the surviving few Faithful behind, but we couldn't take on a whole regiment or whatever they are."

**[Gardner]:** "What's next for the Gauntlet?"

**[Finn]:** "Finish repairing and sign on with Stone. We can't let the Word continue slaughtering innocents."

**[Gardner]:** "Thank you, Captain Finn."

## TIMELINE OF THE JIHAD



**(15 May)** Khan Marthe Pryde is assassinated on Sudeten by unidentified agents.

**(13 June)** The Taurian WarShip *Vendetta* arrives in the Warren system, seeking Hansen's Roughriders. The Roughriders withdraw to Keuterville, but this does not prevent the Taurians from bombarding the planetary capital and spaceports.

**(14 June)** DMI and MIO agents arrest and detain close to fifty "anti-government" leaders in connection with the public movement against the FedSuns leadership on new Syrtis.

**(30 June)** Citing "moral conflicts", Baron Cham Kithrong recalls all Calderon Protectorate forces loaned to the Taurian Concordat.

**(1 July)** The allied forces commanded by Devlin Stone launch simultaneous assaults on the Blake Protectorate worlds of Rochelle, Al Na'ir, Van Diemen IV, and Rio.

**(7 July)** Taurian forces pursuing Hansen's Roughriders bombard Keuterville. The Roughriders withdraw to Firgrove.

**(21 July)** The Ghost Bear-Snow Raven task force supporting Stone's allies moves on Dyev, Sabik, Moore, Lambrecht, Kervil, and Ko. Days later, an heavy deep-raid force hits New Earth, spearheaded by Com Guard troops, in an effort to determine how thin

the Protectorate's interior defenses are.

**(15 August)** Protectorate forces attack New Hessen, employing tactical nuclear weapons and fuel-air explosives to clear and secure landing zones, but the determined defenders on New Hessen quickly trap the Blakist forces planetside. Meanwhile, FedSuns pocket WarShips and the *Fox*-class *New Syrtis* intercept the *Vendetta* and her task force at Firgrove. Both WarShips are damaged, but the *Vendetta* manages to escape.

**(6 September)** The SelaSys shipyards over Loyalty are damaged by commandos from the Principality of Regulus. The partially completed *Venturer*-class light cruiser moored nearby is destroyed.

**(7 September)** Word of Blake raiders—few operating in forces bigger than a Level III—begin striking worlds near the latest allied incursions, including New Kyoto, Algorab, Amity, Bordon, Connaught, Kessel, Alnasi, Ronel, and New Hessen. The Capellan Confederation bears the worst of these strikes, which hit Styk, Tsitsang, Wei, St. Andrea, and Hunan. WMD use on all worlds is reported.

**(9 September)** Allied forces assault Angol.

**(10 September)** The Ghost Bear-Snow Raven

forces working for Stone's coalition expand their cordon into the Blake Protectorate by launching strikes against Skondia, Lyons, and Pike IV.

**(17 September)** The TCS *Vendetta* and her task force return to Brusett, and begin to besiege the planet.

**(2 October)** The FSS *New Syrtis* arrives at Brusett to break the Taurian siege there. In the ensuing naval battle, a nuclear strike cripples the Davion ship, but not before her pocket WarShip escorts can inflict critical damage to the *Vendetta* and force her to retreat.

**(12 October)** A Taurian task force arrives at New Syrtis and hammers the planet with random orbital strikes and aerospace bombing runs, causing crippling damage to the Syrtian Shipyards as nuclear strikes devastate large swaths of the planet's equatorial regions.

**(20 October)** Resentment over the Trial process and Clan protocols for the integrated Rasalhague-Dominion defense forces reaches a boil when the Second Freeman and First Kavalleri Clusters mutiny against Dominion authority. Meanwhile on New Hessen, the Word of Blake insurgents trapped on-planet fall silent.





## THE PROTECTORATE CRUMBLES

### TIMELINE OF THE JIHAD

**(5 November)** Reacting to news of the Rasalhagian mutiny, the Ghost Bears stall their advance and send back all ethnically Rasalhague commands to deal with the situation.

**(18 November)** Allied forces on Yorii uncover two re-education camps where captured warriors from Clan Smoke Jaguar (presumably taken prisoner by DCMS forces during Operation Bulldog and the fall of Huntress) apparently liberated themselves.

**(19 November)** During a festive New Independence holiday celebration on Arboris, a dirty bomb set off by Capellan agitators kills the popular WoB Precentor and several cabinet members. The extreme act polarizes the population into pro-Capellan and pro-Blakist camps.

**(21 November)** Blakist insurgents on New Hessen make a daring daytime raid against

the New Hessen WorkMechs factory and succeed in smuggling a company's worth of mostly-finished 'Mechs.

**(2 December)** AFFS forces launch a series of independent assaults on Mirach, Caselton and Schedar. Lacking allied support (reportedly because they were launched by rogue elements in the AFFS command), these assaults quickly bog down.

**(4 December)** As Ghost Bear forces depart, the Lyran and Combine forces placed on Lyons to garrison it clash over their realms' joint claims to the world. The violent dispute forces Stone to redeploy additional allied forces to Lyons to end the fighting and expel the offending regiments.

**(15 December)** Word of Blake forces launch a counter-assault on Dyev, supported by several WarShips and Pocket WarShips.

**(16 December)** Chairperson Olsen finally

awakens from the coma he had been in since the bombing of the Association Council and begins on the road to recovery as the Niops Association faces harsh political and economic times.

**(20 December)** Sensing imminent defeat, the Taurian forces stranded on Brusett resort to nuclear "scorched earth" tactics to destroy as many FedSuns ground forces as possible. FedSuns Pocket WarShips shell their positions repeatedly, adding to the carnage.

**(22 December)** In the wake of the failed revolt of the Second Freeman and First Kavalleri Clusters, the various disparate Free Rasalhague resistance groups have gone dormant.



## KIRI-J(F) SYSTEM SECURITY SCANNER (12.3.89 BUILD 505)

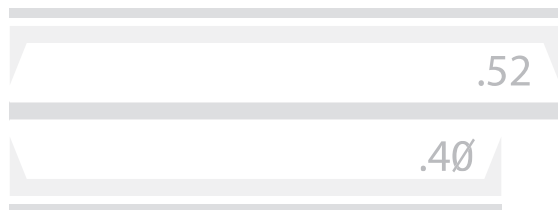

SECURITY LEVEL AMBER



3077: CLOSING THE CIRCLE



## WE WILL SURVIVE

A decade ago, the Inner Sphere was still struggling to recover from the wake of the Clan Invasion and the implosion of the Federated Commonwealth when the second Star League collapsed and the Word of Blake Jihad erupted. After years of battling the Blakist threat, the Inner Sphere has once more united behind one man to turn back the chaos: Devlin Stone.

But Stone and his Coalition offers hope to an Inner Sphere that's been changed—perhaps irrevocably so. The Word's jihadists have committed unimaginable acts of inhumanity in the name of Jerome Blake, unleashing weapons of mass destruction in numbers not seen since the Age of War, releasing the nuclear genie from its bottle. The Taurian Concordat wages a scorched-earth war against the Federated Suns, who replies in kind. The Free Worlds League, rent by loyalties to the Blakists and a false figurehead, now maintains a number of self-proclaimed Captains-General, then

fragments. The Invader Clans, who initially sat in silence while the Blakists ravaged the Houses, now rampage across Inner Sphere worlds, closer to Terra than ever before. The Word's cybernetic Manei Domini demonstrate some of the darkest horrors possible when man and machine combine. House capitals have fallen to foreign invaders for the first time in ages. No place in the Inner Sphere has been untouched by the war we find ourselves in daily.

Yet from this chaos rose the man named Stone. A leader, through his own determination, beholden to no House, possessing no noble bloodline. A force of will who established his own safe zone as the great nations still reeled from Blakist treachery and ancient vendettas. A man who has defeated the Blakists without becoming them, uniting Clan and Inner Sphere powers alike against the Word. With support from other heroic leaders such as Precentor Martial Steiner-Davion,

Duchess Alys Rousset-Marik, General Belle Lee, and *Kanrei* Kiyomori Minamoto, and many others, Stone forged together an alliance from all corners of known space. Clan Wolf and its exiled kin fight together again alongside the Jade Falcons, Ghost Bears, and Snow Ravens. Even the fallen and disgraced Nova Cats have sworn themselves to Stone's side.

Now, after nine long years of bloodshed, bitter and brutal fighting, this allied Coalition is slowly but surely pushing back the pseudo-religious zealots and their cybernetic abominations. World by world, these allies have reclaimed territories fallen for nearly a decade. The cost in lives, materials, and resources is all but incalculable—and it is far from over. Much more fighting, bloodshed, and suffering lies ahead of these weary heroes before peace is achieved and the Blakist menace is ultimately destroyed.

But at long last, we—all of humanity—will have victory.

## THE LYRAN FRONT

## VICTORY AT COR CAROLI

(21 January 3077)

Cor Caroli [TMA] — [A woman in her early thirties stands in front of a Lyran Demolisher in Skye Guards regalia, her hair perfectly coifed.]

"Good evening, this is Myra Kellison for Tharkad Media Associates, exclusive journalists in the Alliance for the united invasion of the Blakist Protectorate. I am here on Cor Caroli where a task force lead by Duke Robert Kelswa-Steiner landed a week ago. And I am pleased to report that in one week, the task force has routed the Blakists and freed the planet. All fighting on Cor Caroli has ceased.

Duke Kelswa-Steiner, taking a page from General Nondi Steiner, smashed the Blakists right in their proverbial noses. The Skye Guards and First Crucis Lancers, with the Seventh Free World Legionnaires protecting their flank, hit the Word forces in a large-scale battle outside of the city of Manovota. The Word retreated later that day with approximately one fifth their number left dead or captured on the battlefield. Two smaller skirmishes left the Blakist force at about half strength before they retreated off planet. Meanwhile, our units under the Duke have only taken minor casualties.

Perhaps Stone overestimated the capabilities and will of the Blakist forces here in the Protectorate? Even at half this rate, the Lyran task force will be on Terra before June this year. We can

only hope that Stone will not hold back the Lyran forces as they prepare to cut deeper into the Blakist threat. Myra Kellison, on a free and jubilant Cor Caroli."

## RETURN TO SUMMER

[Camera pans revealing in the distance the remains of a broken city skyline. Blackened, twisted steel and burnt, shattered walls stand as tombstones. The camera focuses on a rugged-looking man with windblown sandy-brown hair. Next to him is a tall raven-haired man of apparent Asian descent in a Kell Hounds' uniform.]

**[Ruger Winters]:** "This is Ruger Winters for Skye Broadcasting, standing at the fifteen-kilometer safe limit outside the ruins of Curitaba, on Summer. Here with me is the Kell Hounds' commander and CO of the Second Regiment, Lt. Colonel Akira Brahe.

"Thank you, Colonel, for allotting some time for this interview. Can you tell me what kind of resistance you encountered when your regiment grounded?"

**[Brahe]:** "Not much, mostly unorganized thugs and anarchists. Most surrendered, others chose to fight or flee. We have restored order in most areas on this planet."

**[Winters]:** "What are the plans for those people who survived the assault?"

**[Brahe]:** "We are here to provide security, much-needed medical, food, potable water, and other services needed until relieved."

## INTERNAL DISSENT

(2 January 3077)

Coventry [CLP] – Every once in a while history repeats itself, and here is no exception: A multi-national war band has liberated Coventry.

Forged together by a former POW, a new Messiah, Devlin Stone. Delivering our oh-so-powerful but helpless Archon from all worries. Of course the old “enemy of my enemy, etc.” is a sound concept; it only works as long as this newfound friendship can be kept in check. And herein lies the problem.

Weren’t the Clans planning to conquer the Inner Sphere? Isn’t this goal their very reason for existence? Let’s take our “liberators,” the Falcons and the Wolves as an example. Apart from being sworn enemies to the Lyran state up until recently, they possess a history of constantly lunging at each other’s throat. Now suddenly they get along nicely, folding into the welcoming arms of a fuzzy, fluffy, save-us-all Coalition. How can—no—why should that be?

Simple. Because the stubborn-to-a-fault Clanners *learned* from us. They learned how to deceive, to stifle primal urges for long-term success.

And now it’s us again paying them off for their patience. Offering all they ever wanted on a silver platter, garnished with their most sacred prize: Terra. No wonder even the most reluctant Clan leaders agreed wholeheartedly to this coalition! They are fresh, they are at full strength and the sun rises on the horizon.

Grudgingly they were lurking around for decades, waiting for a chance to sneak in our backyard. Now our leaders are treating them to a grand entrance at the front gates.

Right now the party is in full swing. Everyone dances to the tune.

But for how long? Terra draws close!

Archon! React now, while it’s still possible! Or once more you’ll discover your red carpet is soaked in your citizens’ blood.

**[Winters]:** “Do you think that being here will make things all right for these people?”

**[Brahe]:** [*Squints as he looks at the reporter*] “No, I do not. What I do believe is our presence will give them hope and security.”

**[Winters]:** “How can a group of mercenaries give these people hope or security?”

**[Brahe]:** [*Squares himself in front of Winters, face darkening*] “Winters, these soldiers are sons and daughters of the Lyran Alliance, who’ve bled and died so people like you can ask useless, asinine questions like that. We fought this time for the people, not for coin, you pompous ass. This interview is over.” [*Brahe turns around sharply and begins to purposefully walk away.*]

**[Winters]:** [Calls after the receding figure.] “Yes? And failed like Colonel Allard did?”

## 3077: CLOSING THE CIRCLE

**[Off-camera Voice]:** [*Whispering*] “What the hell you doing, Ruger? You lost your mind?”

[*Brahe halts, turns and is immediately in Winters’ face. Winters visibly flinches and cowers.*]

**[Brahe]:** [*With barely restrained violence.*] “Listen, you rat. Daniel Allard gave his *life* against the Falcons so many of us could *survive* and continue the fight.” [*Brahe turns towards the camera*] “We are Kell Hounds and we are *Lyrans*. We gave our lives so many can live. It’s *that simple.*” [*Brahe turns back towards Winters, accenting each word with a savage poke at the man’s chest*] “Do not disgrace Allard’s name again.” [*Brahe glances down, raises an eyebrow, and then looks at the camera.*] “It seems your man soiled himself.” [*Brahe abruptly marches away; the camera focuses on Winters with a close-up showing the urine-stained pants. Quiet chuckling can be heard off-camera.*]

—Previously unaired video from Summer; Skye Broadcasting, 16 February 3077

## SINS OF THE FATHER

It appears we are not the only one with concerns regarding Robert Kelswa-Steiner’s appointment as the task force commander for the struggle on the Lyran front. What the hell is Stone thinking? Robert has on numerous occasions proven that the apple does not fall far from the tree with regards to the “Skye independence” issue. As the head [censored] in charge during the effort to recapture Blakist-held worlds, he will have far too many opportunities to lay the groundwork for Skye sympathy on worlds that will be recaptured. A population is always susceptible to propaganda shortly after changes hands. Worse still is the potential that he may set up the regular Lyran troops under his command to perform some of the more unpleasant tasks that will no doubt require doing. This would lead to lingering resentment, as well as more propaganda to be used elsewhere to discredit the Lyran Alliance.

While it would be impractical, if not outright unfeasible, to demand his removal, we must do our due diligence by preparing sizable LIC contingents to shadow the progress of the “Lyran Thrust” and counteract any malicious acts perpetrated by Kelswa-Steiner. We also may have significant opportunities in the Skye area itself, with the Duke distracted.

But who knows, we might get lucky, and a Manei Domini freak show will show the Duke some “magic tricks.”

—Opinion piece found on the True Tharkad News interworld network, Tharkad, 21 February 3077

## RUMBLES FROM THE REPUBLIC

But is there hope for the citizens living on these new border worlds with the Dominion? Joseph Amergin of the Foundation for Rasalhague Welfare sees some intriguing possibilities in recent news reports.

**[Amergin]:** “There definitely appears to be an undercurrent of discontent among many former Rasalhagians, especially on



## UNCONSCIONABLE!

(5 March 3077)

Galatea [MONTHLY GALAXY] — We have uncovered the following memo detailing actions that are as bad as any in the past decade.

**From:** Col. John Mather, Carnwath Militia  
**To:** LyrComInt  
**Re:** Sabik Massacre

Assigned to garrison the recaptured world of Sabik, my unit was present when the Ninth Sword of Light replaced the victorious Clan forces. We guarded and rebuilt the city while the Sworders focused on planetary defense and guarding POWs. We have done a masterful job, as I'm sure you know. However, I must protest at what I have witnessed from the Snakes. The harsh treatment at first was understandable, as this has been their world since the Combine stole it from the Hegemony.

Over my objections, several Sworders began forcing prisoners to play 'games.' These became more and more degrading and then came the show trials, all with little jurisprudence and only one outcome. The executions began, with several Sword officers competing for how many bodies their katanas could cut through afterwards. I sent another memo to Coalition Command, but again I was ignored. I am requesting LyrCom intervention into this matter, to stop this barbarism and bring them to justice. We did not sign on to become the monsters that we are fighting.

Tell us, Devlin Stone, will you police your own? Will you actually act on your grandiose promises of honor and integrity? We can only hope that you spend the time to prosecute these monsters in your midst! Or will you continue to blame the Blakists for their behavior while condoning the same actions from your "Coalition?" These rogue troops need to be expunged before our forces go any farther. The Inner Sphere will not stand another Amaris.

the seven worlds annexed in 3071. We've been seeing an increase in the amount of anti-Ghost Bear propaganda coming out through traditional channels."

One such channel is the small press. For centuries, resisters of tyrannical institutions have utilized the power of the pen to advance their causes and Rasalhague is no exception.

**[Amergin]:** "During the last few decades of the thirtieth century, the Rasalhague worlds experienced explosive growth in anti-Kurita literature. Pamphlets, flyers, graffiti, even entire novels dedicated to turning up the pressure on the occupiers. The

## CLOSING THE CIRCLE

question now, of course, is whether these tactics will have the same effect on the Clans. I would tend to doubt it."

But the resistance is more than mere words on a page. Though we have been unable to confirm, there have been reports of small-scale violence on several Dominion worlds, violence directed against both Clan forces and those working with them. And rumors of a new organization, calling itself the Motstånd or "Obstruction," call to mind an earlier history of rebellion.

**[Amergin]:** "Oh yes, this is very reminiscent of the Tyr Movement of the early 3000s, which was initially formed from several smaller groups. The difference here, of course, is there is no outside force to sponsor their efforts as the Lyrans did with the Tyr. That, and the Ghost Bears will likely prove a much more intractable foe than the Kuritans ever were."

## WE HAVE MET THE ENEMY

(5 May 3077)

Gacrux [FURILLO DISPATCH] — SBC News' Heinrich Kaufman recently had the opportunity to meet with Lieutenant-General Thomas Hogarth, who became the commander of the Coalition's Group III for the Lyran task force shortly after the tragic demise of the commanders of the Sixth Benjamin, First Federated Suns Lancers, and Thirty-first Marik Militia in a recent decapitation raid. A transcript of the interview follows.

**[Heinrich Kaufman]:** "Thank you for joining us, General, I realize you must be very busy."

**[Thomas Hogarth]:** "Yes indeed! Why, despite my very best efforts, we are two weeks removed from the Liberation Ball. Simply dreadful, but I take full responsibility, of course."

**[Kaufman]:** "Errr, very... gracious of you."

**[Hogarth]:** "Oh, don't mention it!"

**[Kaufman]:** "Perhaps you could say a word or two concerning the recent attack that left you in charge of several BattleMech regiments and supporting troops?"

**[Hogarth]:** "Dreadful business, those Manei Domini! I strongly endorse their total annihilation. They take positive glee in wholesale murder, which makes them wholly unbecoming of any position of violence."

**[Kaufman]:** "Can you tell us what lies ahead for Group III, now that you've established command and control again?"

**[Hogarth]:** "Operational security forbids me from relaying any details in this capacity, I'm afraid! You understand, of course. I can give you one secret though: after the Liberation Ball, we will also have a Farewell Ball, giving Gacrux an opportunity to say farewell to these brave boys and girls. Excellent way to rejoin civilization, if I do say so myself!"

**[Kaufman]:** "Erm, well then, thank you for your time, General."

**[Hogarth]:** "Thank you! It was delightful speaking with you."

## 3077: CLOSING THE CIRCLE



Could history repeat itself? Could we see an independent Rasalhague rise once more from the shadow of oppression?

**[Amergin]:** “Frankly, no. With the Kuritans, they could pack up and leave when it became too costly to hold onto Rasalhague. But since the Bears moved to the Inner Sphere wholesale back in the ‘60s, they’ve got nowhere else to go. They’re here to stay.”

—Excerpt from Skye News Now six-part series “Bears on the Border”, 22 March 3077

**JUST A SETBACK**

(26 March 3077)

Summer [TMA] — *[Myra Kellison looks grimly into the camera, her thin features contrasting with the solemn soldiers in the background.]*

“Coalition officials have just learned that the Word of Blake has attacked Yorii with one of their front-line divisions. Initial reports point to the attackers being elements of the Fourth Word of Blake Militia, but this is not yet verified, nor can we be certain that the Blakists aren’t using false colors to sow confusion.

“Only a garrison force of infantry and vehicular support was present to defend Yorii against recapture. Staffed by volunteers mostly from the Lyran Alliance, these troops stood little chance with second-hand equipment against a Blakist front-line force. The latest intelligence we have received indicates that the invading Blakists slaughtered these brave men and women without mercy. Yorii is lost.

“Duke Steiner-Kelswa has already vowed to not let this action go unchallenged. Commenting that the counterattack was ‘just a setback,’ the Duke has promised that Yorii will be free once again. We can hope that the rest of Stone’s will learn from this terrible miscalculation and the lives of our brothers and sisters will not be wasted in the future. Myra Kellison on a free Summer, grieving for the losses on Yorii.”

**TIPPING THE SCALES**

(25 May 3077)

Inarcs [INARCS PRESS DAILY] — The notorious pirate band “Blades of Death” have struck again, this time here on Inarcs. The attackers assaulted the Acrux, Incorporated import warehouse outside of Oak Grove. The criminals made off with tons of food and consumer products and the ensuing firefight with the Inarcs Militia severely damaged the Oak Creek Power Relay Complex. A massing of the Blackstone Highlanders finally sent the pirates running, but the collateral damage disrupted power to four million local residents. Half of those residents can expect to be without electricity for another week at best, as crews work around the clock in attempt to repair the widespread damage.

Meanwhile, Acrux reports the loss of 324 tons of merchandise—mostly non-perishable foodstuffs. Casualty reports from the Militia indicate four dead, twenty-eight

wounded and the loss of six combat vehicles, including two of the militia’s eight BattleMechs.

Two weeks prior, a consular mission from the Archon was meeting with Duchess LaRue. Special Adjunct Jill Wilson charged that the Inarcs Archonette was building up too much military power on the planet. The Duchess disagreed and stated that “as leader of this Archonette, I need a center point not only to administer from but to base my forces.” While experts have examined mounds of reports, the ensuing weeks have lead to an

**BRING THEM HOME!**

(25 May 3077)

Whittington [WHITTINGON JOURNAL] – Dear politicians, appointed to your well-paid offices by us, the people:

Please, WAKE UP!

Our brothers, mothers, sons and sisters are dying, far away from their homes and relatives.

Please, STOP IT!

300 gravestones lacking a cause are enough!

The tide of destruction spared Whittington, washed over, leaving us safe and sound. Let us be thankful for this! Why should fate be challenged? Why are you chasing after misery, sending our troops to worlds that do not concern us?

Whittington has no part in this. This is not our war. It never was!

And still our troops stand guard over far away devastated worlds, taking care of the vast fields of death and disease left by foreign armies. They must protect governments that do not want our protection. Our soldiers defend people who do not want to be defended, live among civil wars that are not theirs, caught in storms that do not concern Whittington. And they die all the while!

THIS MUST STOP!

As elected representatives of the people it is your duty to safeguard those entrusted to you.

Please, USE YOUR POWER!

Give the word, return our loved ones back to a place where they have a reason to exist.

PLEASE, do not ignore this atrocity any longer. Bring them back. Now.

*NOTE TO ALL READERS: You too can support the BTH movement. Whether it is by simple prayer, a donation (BA 3-56972-00, Keyword “Bring them home”) or at upcoming manifestations:*

- Daily at 09:00, vigil (president’s office)
  - 1 June, 14:00, march for peace (rally at Redwood stables)
  - 15 June, 21:00, candle-lighting (Veteran’s Park)
- signed, The Committee

[EDITOR’S NOTE: The preceding was a paid ad and does not reflect the policies or opinions of the Whittington Journal.]

**3077: CLOSING THE CIRCLE**

impasse with neither side willing to budge from their position. There has been some speculation that LaRue was somehow behind the pirate attack, though no evidence exists for such a theory. Wilson is scheduled to leave in the next few days but the Archon's representative has stated that the situation will be further evaluated by the Archonette's investigative committee.

**SHILOH FALLS**

(18 July 3077)

Shiloh [TMA] — *[Camera view encompasses Myra Kellison and a still-smoldering hulk behind her, the Word of Blake broadsword barely visible on a piece of scorched armor plate.]*

"Good evening, Myra Kellison with the Alliance task force. The battle for Shiloh was not a cakewalk but a hard-fought struggle for a world held tight by Blakist supporters.

"Duke Kelswa-Steiner dispatched two complete attack groups to this world. Unknown to Coalition forces at the time, the Word had not only their Protectorate Militia on Shiloh, but also the Sixth Free World Legionnaires and a force of Manei Domini elite. The Domini savaged the Com Guard's First Army using civilian

cannon fodder unknowingly armed with suicide devices. The Blakists pressed their advantage and Coalition forces were driven off planet for a time, but never out of the system.

"Rallying from one of the moons, the Clan Wolf and Falcon forces assigned to Duke Robert set aside their rivalries and worked together. They dropped right on the Word's base of operations in a dramatic combat assault. After securing the base, the Clanners fought and sacrificed to shrug off numerous counterattacks so that the remaining Lyran forces could land. The Blakist counterattacks included a pair of tactical nuclear strikes.

"As I see it, two rival Clans sacrificed themselves to protect Lyran lives against the common enemy, something I personally found shocking. Perhaps, in this universe gone mad with conflict and hatred, we might find a few truths we previously didn't know existed. While there is little doubt that the Clans remain a threat to our way of life, the actions on Shiloh show that maybe—just maybe—there is some hope for a peaceful coexistence.

"Myra Kellison, on the bloody but reclaimed world of Shiloh."

**WHERE THE HELL ARE THEY?**

(6 December 3077)

Lyons [DBC] – Has Clan Ghost Bear gone on some sort of insane crusade against the Wobbies? Back in 3074 the Bears smashed their way onto Pesht and Luthien without so much as a "by-your-leave." No hails. No *batchall*. No *zellbrigen*. Nothing! Their WarShips chewed through the Blakists' oh-so-powerful fleet as if they were bamboo sprigs and then they *really* got busy! They systematically tore apart every single Blakist they found, taking no bondsmen, no prisoners, and no salvage.

The Clans *never* leave salvage behind!

Stranger, if anyone got too close what did they do? They ripped into them too! Then when they were done they up and left—without a damned word.

Did we appreciate a little liberation? Sure! Absolutely. Who else could have done what they did, our little paper kitties the Nova Cats? They tried. They failed. Did ComStar come to our aid? Not a chance. We were on our own against both the Blakists and our own cancerous growth the Black Dragons.

Yes, we needed help and we would have gladly fought alongside them.

Since then, they have liberated- or, more pointedly, freed - dozens of worlds from the Blakist taint: Dieron, Kaus Borealis, Kaus Media, Kaus Australis, Ascella, Vega, Skondia, Lyons, the list goes on. Their successes against the Word are unparalleled, which is why Stone worked so hard to get them to join the Coalition.

But now I ask where have they gone? As the Coalition prepares to crack the vaunted Protectorate, the Bears have just up and left. Did they come this far only to quit now when it matters most? Was this just some personal vendetta? Have they vented their fury and returned to their dens to lick their wounds?

Bears, where have you gone when we need you most?

**LADY STEINER-FYHNE UNHURT**

(12 September 3077)

Furillo [TBS] — A group protesting the use of potentially toxic heavy metals in ammunition rushed the limousine of Lady Steiner-Fyhne yesterday. The Archon's wife had recently arrived on Enkoping to deal with a malcontent movement protesting over the LAAF's use of depleted uranium, lead, and tungsten munitions to fight the Blakists. She was on her way to meet with one of the movement's leaders when a portion of the approximately 1,500 people awaiting her arrival broke through police lines and surrounded the air car, rocking it back and forth. Unable to move due to the rioters, Fyhne-Steiner and her retinue were trapped for four or five minutes until police could establish an exit route through the throng. Thankfully, Lady Steiner-Fyhne was unhurt and forty-three individuals have been arrested at this time.

With Steiner-Fyhne's next trip to Australia to converse with members of the Friends of Cultural Heritage, we must wonder why the Archon has re-established the Archonettes. Aren't these local issues the reasons that the Archonettes were formed? The Archon has bigger issues to handle, defending our nation and defeating the Blakists. His wife should be charming potential allies and cementing relationships, not trying to pacify the lunatic fringes. Duke Brewer doesn't choose where to put the Gauss rifles on Defiance's *Banshees*, nor does Lord Worthington cast for the next *Steinhearts* character. The Archon should worry about the realm as a whole and give the Archonettes the power to take care of the problems beneath him.

## 3077: CLOSING

**DRACONIS FRONT****OFFICIAL UPDATE**

(29 December 3076)

Luthien [VOTD] – It is with great pleasure that the Voice of the Dragon brings this news to our people! The coalition of forces being built under the neutral banner of Devlin Stone have seen it fit and right to place the command of a large multi-stellar task force under the overall command of our own *Gunji-no-Kanrei* Kiyomori Minamoto.

“It is with the deepest honor and respect that we formally ask the *Kanrei* for his exemplary leadership and strategic personality,” said the coalition’s overall field commander, General Belle Lee. “By assuming command of one of the most challenging routes into the Protectorate, we know that the *Kanrei* will bring nothing but success and honor as he uses the tools provided to liberate those worlds of the Dragon still oppressed by Blakist invaders.”

In an unprecedented move, the Coalition Command has allowed the *Kanrei* to assign *Tai-shu* Isoroku Kurita as his second-in-command. None of the other task forces have a full command team from one House military. The *Tai-shu* is recently recovered from injuries he sustained in the prolonged fighting on Pesht.

“I am honored to serve the Dragon in this capacity,” Kurita said in a statement earlier this month. “I will give my life as necessary, as my kin have done before me, to release our people—and all people—from the talons of the Yellow Bird.”

The *Kanrei* and his staff will be leading a task force that contains several prestigious units from across the Inner Sphere, including the Combine’s own First Sword of Light, Second Dieron Regulars, and Second Genyosha. Other forces under the *Kanrei*’s command include Clan Wolf’s Iota Galaxy, the Second Davion Guards, and several Lyran and Free Worlds regiments. Four of the Combine’s mightiest WarShips will also accompany the *Kanrei*, including the *Takashi*, *Dieron Star*, *Victory at Wolcott*, and *Lair of Mighty Wyrms*.

Truly, only success awaits the Dragon in purging the Blakist blight from the universe.

**DEAD CLAN RISING?**

(15 February 3077)

Benjamin [DRAKE] – The once thought dead Clan Smoke Jaguar has been found on Yoriii! An embedded journalist within a task force there has reported that a motley collection of Smoke Jaguar Clansman were found during Stone’s liberation of Yoriii from Blakist Protectorate forces in January. Among the many obvious questions are perhaps the most two pressing of all, how did they avoid destruction at the hands of the Second Star League, and are they in collusion with the Blakists?

Answers are short in coming and as usual, Stone’s people are not talking.

According to the same source, Stone’s Lament stumbled

**DCA READINESS REPORT**

(7 January 3077)

Buckminster [DRAKE] – The following is excerpted from DCA report to DCMS, dated January 3077:

&gt;&gt;Begin Message&lt;&lt;

Since the collapse of the Star League and the Blakist war, the turmoil within the Dragon has led to distinct lack of leadership and control over the WarShip fleet of the Draconis Combine Admiralty. Only recently with the restoration of central leadership has it been able to appraise the state of the Fleet.

The DCA in 3067 had fourteen operational warships; four *Kirishima*-class vessels, five *Kyushu*-class, four *Inazuma*-class, a *Tatsumaki*-class and an *Essex*-class. In addition, there were two ships in mothball around Dieron, the *Dark Claw* (*Essex*-class) and *Lioness* (*York*-class), both salvaged from the extermination of Clan Smoke Jaguar.

Since then, five vessels have been lost by the DCA; DCS *Siriwan* (*Kirishima*-class, Algedi, 3072), DCS *Galedon Explorer* (*Kyushu*-class, vs Clan Snow Raven, Galedon, 3068), DCS *Luthien* (*Kyushu*-class, vs WoB, Benjamin, 3072), DCS *Night of Agony* and DCS *Swiping Claw* (both *Inazuma*-class, lost over Benjamin in 3072).

That three of our WarShips were hijacked by the Black Dragon Society came as a deep shock. It was assumed that ship commands would be thoroughly vetted after a previous incident cost us one WarShip over Alshain. Investigations has shown that “sleeper” agents of the Society instead managed to receive key positions within the DCA, allowing them to gather sympathetic crews aboard the DCS *Urizen II* (*Kirishima*-class, destroyed at Avon in 3072), DCS *Sabre Cat* (*Essex*-Class, still missing) and the DCS *Winds of Heaven* (*Inazuma*-class, recovered, on classified mission). A thorough purge by the ISF has rooted out these agents, and uncovered additional potential risks onboard three more vessels that have been eliminated.

The following vessels are thus currently available to the DCMS for deployment against the Word of Blake, and liberation of the Dragon’s worlds:

*Kirishima*-class: DCS *Takashi**Kyushu*-class: DCS *Dieron’s Star*, DCS *Draconis Rift*, DCS *Victory at Wolcott**Inazuma*-class: DCS *Amber Lotus* (DCS *Winds of Heaven* is currently on assignment)*Tatsumaki*-class: DCS *Lair of Mighty Wyrms*

&gt;&gt;Message Terminates&lt;&lt;

onto them during combat operations in November and very nearly opened fire before realizing they were not, in fact, Blakist combatants. The Jaguars were all rounded up and shuttled away from prying eyes.

What will the Dragon do in light of these revelations? Even now, rumors of the Smoke Jaguars’ capture have spread like wildfire among Coalition forces. Many veterans of the Clan Invasion, including some who fought on Luthien and





## 3077: CLOSING THE CIRCLE

## DO NOT DENY ME

General Lee:

Truly you misunderstand the honor of the Dragon in your recent adjustment of my orders.

I do not understand why it is deemed important that these planetary militias from the Federated Suns be tasked with defending the liberated Combine worlds of Telos IV and Deneb Algedi. The recent arrival of the Valexa Militia on Deneb Algedi is nothing short of a blatant disregard for the people of the Combine and all they have endured.

It is my responsibility to safeguard the citizens of these liberated worlds. By your overriding orders, you have undone many months of planning and logistics that my staff and I have conducted. The people of the Dragon deserve to be protected by their own House, not the sycophants of one of our ancient enemies! To put such "weekend warriors" in place jeopardizes the defense of the system, not to mention the morale of the populace.

I strongly suggest you reverse your orders and allow the Toguran Military Garrison and the New Samarkand Militia redeploy on their original assigned worlds. I have already received complaints from the commanders of these garrison forces for their forcible redeployment to worlds in the Marik theater; you threaten not only the morale of our forces but also threaten to destabilize these worlds so recently freed.

I cannot be responsible for what may happen if the situation continues to worsen.

—Missive from the office of the *Gunji-no-Kanrei*, 29 March 3077, leaked by unidentified sources (veracity confirmed)

with Task Force Serpent, are clamoring for *Kanrei* Minamoto to pressure Devlin Stone to enforce the original Star League mandate under Operation: Bulldog. Leaving the job undone risks far too much, considering the threat the Jaguars pose. The possibility of the most hated of Clans rising from the ashes of their defeat to menace the Dragon anew is a chance far too dangerous to take.

Curiously, since their discovery there has been no further sign of these vile warriors or information pertaining to their whereabouts. Stone's command staff has stifled all requests for information on the subject, though rumors abound that they may have been escorted to some haven beyond the Inner Sphere for their "protection."

Stone, the Drake urges you: take action to end the threat these Jaguars represent! If not, then the Dragon will.

### OUTRAGE

"They're just Dracs; nobody important." These were the words spoken by Lieutenant-General Lucas Hoffman of the Nineteenth

## STATUS: TELOS IV

(2 April 3077)

Luthien [DRAKE] – This *borrowed* transcript come from an exchange between a LAW satellite branch on Telos IV and their corporate offices on Luthien.

>>BROADCAST INTERCEPT: LAW6387-TE42157; Excerpt commences: 13:31 (Terran Standard)<<

...believe to be twenty-seven percent or below previous capacity throughout all three facilities.

Remaining ferrous alloy, manganese and tungsten processing lines are functioning at or below seventeen percent of requirements. Analysis is ongoing. Initial outlook is not encouraging. Salvage and repurposing efforts may yet bear fruit.

#### Kilns: Ceramic Production:

Triumph, Dulles – Fourteen percent of original capacity; quite good considering the severe level of damage sustained by WoB WMDs.

Stanly & Sons, Dulles – Zero percent production capacity due to on-site detonation of high-yield, nuclear device by saboteurs. Severe radiological contamination continues to hinder in-depth assessments. Site decontamination and recovery operations may yet bear positive results.

Pembrose, Rustov – Forty-three percent capacity. Recommend up scaling this site to account for losses elsewhere.

#### Material Output:

Liberal use of WMDs by both WoB and DCMS forces in and around Triumph has endangered the project completion date. Current projections are constrained due to lack of on-site inspectors. Request HAZMAT qualified assessors immediately. Best-guess estimates place total production yield at or below thirty percent in all sectors except as noted. Outflow is inconsistent with DOFYAM1267 requirements.

#### Recommendat...

>>data stream interrupted<<

>>INTERCEPT TERMINATED<<

While you have to applaud LAW for not putting all their eggs in one basket, one must question their reasoning for investing so heavily in a backwater like Telos IV in the first place. And what is this mysterious "DOFYAM1267"?

More importantly, why the hell is *Kanrei* Minamoto allowing nukes to be used so freely on the Dragon's soil? We have to *live* here afterwards. This is a case of cutting off your *head* to spite your face.

Are we the Draconis Combine or the Capellan Confederation?

## 3077: CLOSING THE CIRCLE



Arcturan Guards just days ago as he climbed into his *Barghest* on the way to the Styx DropPort.

Never in my thirty years of journalism have I heard more callous words spoken about fellow human beings. "Just Dracs"? "Nobody important"? Fifteen thousand innocent men, women and children died horrible deaths as two tactical air-burst nuclear weapons detonated three hundred meters above the Styx Protectorate Militia base, flattening everything in a one kilometer radius.

Why would someone do such a thing you ask? Easy: rage and expediency.

Just hours beforehand, the First New Ivaarson Chausers were ambushed by the Styx Protectorate Militia as the Chausers searched for salvage outside the capital drop port, the site of an April battle between the Word of Blake and the Second Dieron Regulars. The Chausers were badly mauled in the fighting and forced to withdraw. Unwilling to wait for reinforcements and with his precious timetable in jeopardy, Hoffman flew into a blind rage. Deciding to give the Blakists a taste of their own medicine in the form of a nuclear missile surprise, Hoffman ordered the attack delivered "right down their bloody throats."

Never mind that their base was located in the middle of a sprawling city.

Never mind that thousands of innocent women and children had no warning and no time to evacuate.

Never mind the hospital, the two schools, and the church that sat within the blast radius. They were "just Dracs."

Now, because of one man's hubris, an entire city is dead or dying.

All life is important. Even a bloodthirsty Lyran should understand *that*.

If this is Stone's idea of "liberation through cooperation" then he can choke on it. Perhaps we are better off under Blakist rule?

—OpEd by Ariel Blonday, posted by the Styx Drake, 15 May 3077

**OFFICIAL UPDATE 2**

(25 May 3077)

Asta [VOTD] — Under the personal command of *Tai-shu* Isoroku Kurita, Coalition forces assigned to liberate Asta as a staging area for the eventual assault on Dieron burned in with surprisingly little resistance from the Blakist occupiers. Once on the ground outside the all-but-destroyed planetary capital of Excaliba, our noble forces faced stiff opposition that was finally broken by the arrival of the Second Genyosha. With the Ghost Bears off securing the Moolai continent, it fell to *Tai-shu* Kurita to ensure that the Blakists were routed from the planet.

In that endeavor, our forces were aided by an unexpected development. Intelligence going in had reported that the Blakists had set up a number of large reeducation camps on Asta, but what no one expected were that many of these camps were in open rebellion at the time of the assault landings. These uprisings apparently began about a week before the assault,

originating in a camp just outside the port city of Logan before spreading to other camps scattered across the continent.

Once the remains of Excaliba were secured, *Tai-shu* Kurita was able to use the chaos of these prison uprisings to quickly roll up the distracted Blakist forces on the Balerdo continent. A campaign expected to take more than a month instead lasted less than three weeks, with the majority of the toughest fighting taking place the first few days after landing. This will undoubtedly have a beneficial effect on the coming Dieron campaign, though Coalition commanders have so far not commented on the matter.

And the camps contained another surprise. Among the rebellious prisoners—in fact, leading them—was Colonel Andrew Redburn, formerly of the Star League Defense Forces, last seen during the Blakist assault on Tukayyid ten years ago. Though in somewhat poor health due to his incarceration, the Colonel appeared willing to continue the fight and has reportedly requested a meeting with Devlin Stone and his aides at their soonest convenience. His recovery after being presumed dead for a decade gives hope to everyone with missing loved ones.

**QUENTIN QUAGMIRE**

(21 June 3077)

Quentin [AL NA'IR DRAKE]: After nearly two months of continued fighting, the forces under the command of *Kanrei* Minamoto have gained little ground in their effort to liberate Quentin from the forces of the Word of Blake and their sympathizers. What began as a "swift and easy victory" has bogged down into a guerrilla war. Blakist forces remain at large and able to conduct terrifying hit and run strikes on almost any target. The *Kanrei's* troops have been forced into a grinding, methodical search to root out forces they now call "terrorists."

When Minamoto's liberation force arrived in early May, it appeared that the Word of Blake would be no match for their invasion. Despite the Militia's fanatical attempt to hold back the first wave, the Dragon's armies and their allies quickly seized all of the major population centers as well as the primary spaceport. It was thought, at that time, that major combat operations had been completed. Two weeks later, however, the destruction of three DCMS DropShips and a reported assassination attempt on the *Kanrei* himself proved that the Word of Blake had merely gone to ground. The fate of Quentin remains very much in doubt.

Since that time, the people of Quentin have witnessed house-to-house searches, random loyalty testing, seizure of assets, and most recently, the declaration of martial law by the Kuritan authority. As the Word of Blake continues to wage its war of terror, the forces under Minamoto's command grow more tyrannical in their efforts to find and eliminate them. Their increasingly brutal methods have reached the point where more citizens of Quentin are detained or harmed than actual Blakist sympathizers or warriors.

**3077: CLOSING THE CIRCLE**

Certainly, the people of Quentin long to have their world free from the clutches of the fanatical Word of Blake—but as civilians increasingly become suspects, detainees, or in some cases, casualties, we must ask ourselves if this form of “freedom” is worth the price?

**OFFICIAL UPDATE 3**

(20 July 3077)

Quentin [VOTD] – After three months of fighting, *Kanrei* Kiyomori Minamoto and the forces of the Coalition’s Draconis Combine Thrust have defeated the Word of Blake’s vaunted Forty-seventh Shadow Division on Quentin. This hard-fought victory was not without its tribulations.

Initially, when the task force arrived, it faced only the Quentin Protectorate Militia, a force that fell in short order. Yet all signs pointed to a larger—albeit hidden—presence on this important industrial world where Independence Industries, maker of the *Atlas* BattleMech, has made its home.

The *Kanrei*’s suspicions were soon realized when Blakist commandos first destroyed several DropShips and then made an attempt on the *Kanrei*’s life. Yet the Dragon remained strong and the assassins were soon captured or killed. Still, increasing riots and demonstrations against the task force’s presence proved that more roguery was afoot.

In May, the Forty-seventh Shadow Division revealed its presence by launching an ambush against an over-extended Clan Wolf patrol. Two Stars of ‘Mechs were destroyed, which coincided with a lengthy lapse in FedSuns air cover over the northern hemisphere. Taking advantage of the gap, Blakist vessels somehow slipped into orbit and dropped several Level IIs onto the planet.

The situation worsened.

The Blakists, emboldened by their reinforcements, launched vicious attacks against both the Task Force troops and the general populace. Each time they were driven back. Unable to win conventionally, the Blakists launched several biological attacks against the Coalition, spoiling hundreds of tons of food and supplies and sickening dozens; the actions of cowards.

Finally on 10 July, *Kanrei* Minamoto launched a brilliant strike against a discovered mountain base near the capital, trapping the enemy in a pincer movement. The First Sword of Light and Tau Galaxy then crushed the Blakist Manei Domini, though a few stragglers escaped under the guns of their newly arrived WarShip.

Thus, despite the lapses of our allies, did the brave soldiers of the DCMS win yet another lasting victory for the Dragon.

**NEXT, ON TO DIERON!**

**WE WILL NOT FADE**

People of the Dragon, hear the words of wisdom from the servants of the Dragon’s soul. The pretenders who claim to

**INTOLERABLE DISSENT**

(1 September 3077)

Ludwig [DRAKE] — At last, life is returning to normal.

With a dawn raid at our facility on Ludwig, the ISF began a two-week campaign to round up anyone associated with the Drake on this planet. Their criteria for “association” were quite comprehensive. By last count, they incarcerated nearly 1,200 individuals, despite a local staff of only twenty. Most of these poor souls have yet to be released.

These tactics are not unfamiliar, of course. The same discipline existed during the reign of many Coordinators. There is but one “Voice of the Dragon,” they claim, a tradition many seek to reinstate.

The raid itself should come as no surprise, of course. Our brethren here had the *audacity* to question the Dragon’s wisdom with regards to allowing *gaijin* forces to garrison recently recaptured worlds. They did not realize that our troops are far better utilized fighting and dying against the Word of Blake, while our “noble allies” ensure the safety of our worlds, as stewards of our way of life. Our Coordinator’s intelligent policy should not have been questioned—even slightly. After all, questioning the Dragon is the same as sowing dissent. It is the same as siding with the Word of Blake.

How unfortunate, then, that we have refused to learn our lesson here on Ludwig. We will continue to report as we have—foolishly and unwisely—until the ISF comes to visit us and our closest thousand or so associates as well.

Such is the Dragon’s Will.

defend the honor of the Draconis Combine failed in their attempt to assassinate our leadership here on Qandahar with their elite ISF operatives. They failed and paid with their lives.

We are the true Keepers of Faith, sons and daughters of the Dragon. We hold true to the original charter that gave birth to the glorious Dragon’s realm, our Combine. The *Kokuryu-kai* remain firmly rooted here, steadfast in our unwavering faith in the Dragon’s honor, the way of the conqueror—not the ways of the corrupt and contemptible Coordinator.

Nearly fifteen days ago, the ISF’s assassins came to “deal” with those who support us here on Qandahar. They assumed we would surrender our lives and our honor to them; that we would cower in fear of the dreaded ISF. How wrong their assumptions proved to be! Do they believe they can force the Dragon’s spirit into submission?

Let there be no doubt of our words, our determination, or of our will. We grow stronger than ever before! As the Misogi War grows, so shall we!

Let it be known, we will not be broken! We are emboldened by their lack of faith and vision. We, the *true* children of the

3077: CLOSING

**RIGHTEOUS FIRE**

(12 September 3077)

Lyons [DRAKE] — And for an update on Lyons, here's an exciting excerpt from a local broadcast from our brothers there:

**>>Sunburst in the Morning, Lyons; Excerpt commences: 08:14 (Lyons Standard)<<**

*[Two hosts and two guests are seen from the front. Each is seated in an over-stuffed armchair. The impeccably dressed male host starts.]*

**[Oleg Lipskis]:** "And now, we'd like to talk about the military here on Lyons. With me is Misiko Mundrha, liaison to the Lyran occupiers. Tell us Mr. Mundrha, what have the Lyrans been up to?"

*[Mundrha has a more regal bearing and dark features that belie an Eastern Indian heritage.]*

**[Misiko Mundrha]:** "Well, Mr. Lipskis, the Lyrans have once again shown themselves every centimeter the dishonorable culture that we have come to expect. They show little respect for the Dragon's forces, and insist on treating us as the invaders here."

*[Co-host Kiko Suzuki, wearing at least a dozen forms of visible cosmetics, gasps and covers her mouth.]*

**[Mundrha]:** "Yes, indeed. Additionally, they have been bullying the lawmakers in the regions they are overseeing, forcing changes in policy more in keeping with Steiner philosophies, rather than those that served this world since the late Coordinator Theodore moved in. Disgraceful."

*[The other guest, a slight woman with a fierce demeanor, leans forward.]*

**[Ginger Ho, Lyons' People's Council]:** "And furthermore, they have been forbidding our broadcast campaigns. Apparently simple educational programs that explain the culture of the Combine threaten them."

*[Kiko Suzuki shakes her head.]*

**[Ho]:** "The latest polls show an increasingly unfavorable view of the Dragon, planet-wide. Obviously we cannot let the good people of Lyons be misled again."

*[Lipskis turns back to the camera.]*

**[Lipskis]:** "That is the Dragon's Truth, Mr. Mundrha. We'll return after this word from our sponsor."

**SAFFEL HPG OFFLINE**

(3 December 3077)

Ashio [VOTD] – All citizens relying on interstellar communications, please be advised of the following announcement. This is an official press statement from the local ComStar office:

"ComStar Interstellar Communications regrets to inform our customers of an interruption in our services. Effective immediately, all HPG operations to and from Saffel are put on hold due to unforeseen local technical difficulties.

"Our specialists are working hard to rectify the situation and will inform customers through regular updates on our progress.

"As is our high standard in client servicing, an alternative is already available at your local HPG compound. The local merchant guild has sent a representative to help facilitate negotiations with spaceport officials and JumpShip captains. Please note that ComStar cannot be held responsible for any damages effectuated by prolonged delivery time and/or elevated costs.

"Unfortunately, we are also obliged to inform that the current downtime began on 27 November, thus affecting all video and data packages scheduled from this date forward. We invite all customers in question to retrieve their transmissions personally. Reimbursements will be credited to your next ComStar order.

"ComStar apologizes for any inconvenience."

Dragon, will not simply fade away. In the beginning, we existed. In the end, we shall overcome the oppressors to lead the Dragon's children into a new and brighter future.

—Reputed Black Dragon broadcast on Qandahar, 18 November 3077

**OFFICIAL UPDATE 4**

(25 December 3077)

Dieron [VOTD] — The campaign for Dieron is finally at an end. After two months of some of the most horrific fighting I have ever been witness to, the Coalition claims victory. Only a few pockets of resistance remain, although I am assured that none can resist anything "more than a single BattleMech". I have heard that troops are en route to clear such pockets, leaving the valiant Ghost Bear and Dieron Regular troops for other purposes.

The campaign had many tense moments, including brief fighting between Dieron Regular forces and elements of the Ghost Bears' second line troops. While the exact details that led to such a "friendly fire incident" have not yet been revealed, it is known that the Ghost Bear Khans have apologized for the incident in their own way to *Kanrei Minamoto*.

Few can deny that this dismal event is irrelevant in the face of other actions by the allies. The Second Dieron proved its mettle numerous times, mostly notably during the assault on

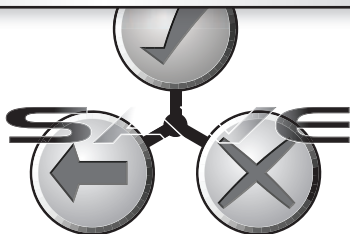



## WHY MUST WE?

**[Thom Hager]:** "Next item: Devlin Stone. Major Pasquale?"

**[Major Ephraim Pasquale, Ret.]:** "Who is this clown, anyway? How do we know he's not some Blakist plant?"

**[Lieutenant Alois Jayanti, Ret.]:** "Oh, please! He's no more a Blakist plant than my mother is."

**[Captain Stephanie Warren, Ret.]:** "Lieutenant Jayanti is right; there's no evidence Stone is a plant of any kind."

**[Pasquale]:** "Of course you'd say so, Captain. You're the one pushing for us to join his alliance."

**[Warren]:** "I merely think it's the height of foolishness to insist on doing things ourselves when there are ready allies at hand."

**[Pasquale]:** "But we're the Federated Suns! We didn't need help when we kicked Cappie ass back in '28, did we?"

**[Jayanti]:** "Are you serious? What about a little thing known as the Federated Commonwealth? The Lyrans, remember?"

**[Pasquale]:** "Bah. They were more of an albatross than an aid. And look at how *that* all ended up."

**[Hager]:** "Please, please, let's not rehash the civil war again. The topic is Devlin Stone."

**[Warren]:** "Look, the fact of the matter is that today's AFFS faces a number of external challenges that make it necessary to find allies where we can. The Snow Ravens, for one. After the fiasco with the Third Crucis, who wants to leave that border weakened or, God forbid, undefended?"

**[Pasquale]:** "Those motherless Clanners wouldn't dare."

**[Warren]:** "Wouldn't they? Look at what happened with the Falcons and the Lyrans or the Bears and the Dracs."

**[Pasquale]:** "They aren't the FedSuns."

**[Warren]:** "What about the Taurians? They're still carrying a mighty big mad-on for us. Or the Capellans. You don't think they've forgotten Sovereign Justice, do you?"

**[Jayanti]:** "Filtvelt."

**[Warren]:** "Yes, Filtvelt! We're going to have to do something about them sooner or later. Face it, we can't do it all ourselves."

**[Jayanti]:** "We need Stone and Stone needs us. It's that simple."

**[Pasquale]:** "I pity our future if you two are indicative of the current state of the AFFS officer corps."

**[Hager]:** "And on that note, we've got to take a commercial break."

—Transcript of *Thom Hager's Capital Connections*, NANS, 13 February 3077

Fortress Dieron, where it was instrumental in securing one of the breaches that led deeper into the fortification. Perhaps even more noteworthy are the efforts of the Eighth Dieron under *Tai-sa* Jerry Simms. Responsible for an even more tactically advantageous breach, the Eighth further distinguished itself on the summit of Mount Shanyu, where it engaged the Blakist Second and Nineteenth Divisions with aid from the Bears' Omega

## CLOSING THE CIRCLE

Galaxy. At the tip of mountain, the samurai of the Eighth proved that the Dragon's ferocity matches that of the Ghost Bear, and that Dieron warriors can even outpace the Bears in the swiftness of their fury. Though the *Tai-sa* himself fell honorably in that battle, his Eighth carried on without him.

While there may be many reasons to have feared for the future of the Dragon, after the fighting here on Dieron, I fear no longer.

## FEDERATED FRONT

## FORGIVEN, BUT NOT FORGOTTEN

Princess-Regent,

You should be proud of your troops' victories at Mirach, Caselton and Schedar. Defeating such a deeply entrenched foe is to be commended. The cost, however, cannot be easily overlooked—what price is too high for freedom, after all? Now, I'd be a hypocrite if I didn't welcome the victories; anything that pushes the Word back is something to be welcomed. But I would be lying if I were not concerned about what this uncoordinated attack may have cost the greater effort to defeat the Word of Blake.

One of Terra's great freedom fighters once said, "We must hang together, else we shall most assuredly hang apart". I fear you have not truly taken those words to heart, nor the advice of your brother. Your Castle Avalon strategy may do well at keeping the barbarians from the gates, but what if those barbarians control the water that flows into your city? If the Word of Blake is not unseated from Terra, it will not be long before they decide to send us into another blackout. Your military might survive on its precious faxes, but what of your worlds?

We stand ready to engage in the largest military action since the first Liberation of Terra, and your commander is haring off on uncoordinated attacks that put the entire Rimward Operations Theater at risk...

Dearest,

For all that he speaks truth, we can't replace Katheryn as our operational commander at this late stage. Yes, she jumped the gun. Yes, she didn't even inform Jon or myself. But to replace her now would severely damage the morale of the troops and drive further wedges into the Draconis March old guard.

Remember, they follow you, not Stone. But if you are seen as weak, they will not follow even you.

—Tancred

—Partial message from Devlin Stone to Yvonne Steiner-Davion (annotated by Tancred Sandoval), NANS Archives, dated 15 February 3077

## S.O.S.

**[Gunsmoke Six]:** "Third Recon's dead, I'm taking massed fire from pillboxes on the west ridge."

**[Alpha Actual]:** "Gunsmoke, pull back through bearing 275! Steel One, full company fire pattern at grid 720 to 724!"

**[Gunsmoke Six]:** "Ronin's down! Mac, we're getting slaughtered."

**[Alpha Actual]:** "Honour, get the hell out of here. Tell the Colonel we are executing Ground 12."

...That is one of the last communications received from the Battle Corps Legion, in what appears to be a recon raid gone horribly wrong. Part of General Belle Lee's mobile command, the Legion was assigned to recon Yangtze ahead of the FedSun Thrust's first wave. Combat logs from one of the Legion's surviving transports show that more than a company was wiped out in the first thirty minutes, with the rest of the mercenaries' Alpha Battalion going to ground after sustaining heavy casualties. With all communication lost, and the Word defenders far more numerous than anyone previously believed, the survival of the Battle Corps Legion is in great doubt.

The Legion is no stranger to tough situations. In January of 3073, their second battalion was nearly wiped out after the infamous Opacus Venatori caught them on Liberty. Equally bad luck dogged them on Alula Australis in 3068, and Kansu in 3067. Yet they've always managed to eke out a victory. But faced with more than five-to-one odds and an enemy that was clearly expecting them, their luck may have finally run out.

In stark contrast, the Twelfth Vegan Rangers have turned their raid on Addicks into a near rout for Word's defenders. We've just received confirmation that Marshal Sandoval-Ito has pushed forward the planned liberation of Addicks by a full month. A testament to their long traditions of success, the Rangers show us what the skills of a centuries-old command can bring to this battle.

—Peter Remonde, FSNS, Tikonov, 23 February 3077

## TRAGEDY ON DEMETER

Once again, our peaceful world is invaded and subjected to the ravages of war. Only this time it is not from the Capellan military, but the God-damned Davions! The AFFS military and their allies landed *en masse* on the first of February. With them they brought destruction unparalleled in the history of Demeter.

The Fifth Crucis Lancers and the Lyrans' Fifteenth Arcturan Guard assaulted Vicore Industry's manufacturing complex, only to be thrown back by our own Protectorate Divisions and the Word of Blake's *Measure of Trust* and *Call to the Faithful*. Initially, the invaders moved within ten kilometers of Vicore's complex, but a coordinated effort from our forces pushed the Davion aggressors back, forcing them to retreat towards their drop zone. Then, however, the Free Worlds' Third Legionnaires arrived and made an orbital drop, forcing our defenders to fall back.

For three weeks, no one gained an upper hand until the

## CLOSING THE CIRCLE

Davion commander—that bloodthirsty bastard—called down a strike against our troops from orbiting WarShips. Our Blakist allies ordered our own troops to defend New Demeter City and its civilian population while they fell back to the massive Vicore complex. Davion and Steiner forces surrounded the city, while the League's command encircled the complex.

Then on 28 February, the Davion-led force assaulted New Demeter City. At first, they gained a foothold through bloody street-to-street fighting. But by the third day of the assault, our own citizens entered the fray against the invaders, using whatever weapons they found and receiving unimaginable carnage, damage, and loss of life. The Legionnaires fared no better against the Blakist defenders—until, once again, orbital bombardment rained down from the invaders' WarShip and utterly destroyed the Vicore complex and its valiant defenders. New Demeter City also suffered massive indiscriminate strikes that decimated our hapless defenders, but we fought to hold on until, finally, our surviving planetary rulers surrendered, an act that came only after the Davions threatened to raze the continent and salt the soil. What the FedSuns and their allies perpetrated on Demeter rivals the butchery Kentares IV suffered.

—Keevah Acee, Demeter Free Press, 17 March 3077

## FIRST WAVE COMPLETE

(12 April 3077)

Tikonov [FSNS] — The Coalition's Federated Suns offensive got off to an official and successful start with a staggered first wave that saw four worlds targeted for liberation. Under command of Marshal Katheryn Sandoval-Ito, and supported by such legendary men as General Galen Cox and Khan Phelan Kell, the joint FedSuns task force is coming together quickly and has every appearance of living up to the expectations of the longest road to Terra.

At Tybalt and Addicks, Group III and Khan Kell's Group IV were both able to quickly rout the Word's Protectorate units and secure the planets. On Tybalt, the capital's citizens held the first victory parade in its history where the guests of honor were the men and women of a Draconis Combine unit.

Sandoval-Ito personally led the expedition to Yangtze, bringing with her all three of the Federated Suns' *Fox*-class corvettes to bolster the attack on the world's reinforced defenders. Capitalizing on battlefield intelligence from the surviving members of the Battle Corps, the Marshal's forces were able to outflank the enemy defenders and use tactical strikes from orbit to eliminate the largest pockets of resistance.

At Algot, the veteran First Davion Aerospace Wing acquitted itself well when Group II was attacked at the jump point—the only issue being that their opponent was the CCAF and not the Word of Blake. The First quickly withdrew from the system, leaving the Capellans to deal with Blakist defenders.



## 3077: CLOSING

Reportedly, Devlin Stone instructed Marshal Sandoval-Ito to withdraw at that point and avoid further conflict with Confederation forces. Given the Capellans' continued unwillingness to rally with the rest of the Coalition, this advice is no doubt very sound. With a successful first wave complete and early coordination issues hopefully a thing of the past, the Federated Suns front is preparing for its second wave in the drive for Terra.

**THE TALE OF TOWNE**

(22 April 3077)

Towne [ROBINSON GAZETTEER] — As they say, it is all over but to count the dead. After four weeks of intense fighting, the Federated Suns and its Coalition allies has liberated Towne from the Word of Blake. What began nearly three months ago with a daring recon raid by the Fox's Teeth, ended five days ago with the Teeth's departure. With the planet under control, the Fifteenth Arcturan Guard is lifting off today, headed for its next target, while the rest of FedSuns Group I is refitting, and helping the civilian leadership take over as garrison forces are moved in from Tikonov.

The victory, however sweet, was not without its trials. The most intense fighting occurred on the mountainous continent of Howell. Nestled deep within its mountain range, the Word had constructed a DropShip facility capable of extensively refitting DropShips, if not outright construction. With defenses just this side of a Castle Brian, the Suns' advance ground to a standstill. So deeply entrenched was the Word of Blake, failure a very real possibility. Only after receiving direct permission from Princess-Regent Steiner-Davion, the FSS *Indefatigable* moved in and conducted a pinpoint orbital bombardment of the military facility, breaking the Word and finally freeing Towne.

Even this came at a deadly cost. Despite the brave efforts of Captain Ross McKinnon and his men, who managed to neutralize the ground-based capital missile launchers ringing the DropShip facility, the *Indefatigable* almost never made it to Towne's orbit. Hidden within the planet's asteroid belt, disguised as ore processing stations, were more capital missile launchers. Activated by the passing of the Fox-class WarShip, the launchers spewed forth dozens of missiles from thousands of kilometers away. Only activating as they closed on the WarShip, the ballistic-fired missiles heavily damaged the *Indefatigable* and nearly doomed the liberation of Towne.

**LIBERATED ARCHERNAR**

[The video image shows a flak-jacketed reporter carefully picking his way through the edge of a debris field.]

[Remonde]: "Three weeks ago this rubble was the north wall of the Achernar BattleMech's West Fabrication Facility. A long-time producer of IndustrialMechs, it had been recently restored by the Word. Just weeks ago, hundreds of workers were inside, building the new *Osprey* medium-class BattleMech. Today, they are still there, but this once impressive facility is now their grave. This pile of rubble their only headstone."

**SITUATION REPORT: NAVAL DEFENSES**

To: Coalition Command Headquarters (CCHQ)  
Fr: Field Marshal K. Sandoval-Ito (FEDSUNS THRUST HQ)  
Re: Urgent Advisory  
Dt: 7 May 3077

Be Advised:

FS Group I elements invaded Hean system on 3 May

Encountered SDS now believed to be equipped with multiple layers of functionality.

*Indefatigable* (Fox-class) lost, as well as significant aerospace assets.

Significant losses to the 15 Arcturan Guard and Fox's Teeth.

Forces withdrawn from system.

Hostile deployment of SDS in excess of prior estimates.

Losses in excess of estimations.

>><<

The Federated Suns' naval deployment to Stone's coalition is noticeably smaller than the commitments of other nations, but represents a major proportion of our surviving naval assets. The loss of the *Indefatigable* is therefore more severe in proportion. Significant naval assets are a requirement in a post-Jihad environment and greater emphasis must be placed on retaining the assets we have.

Encourage use of alternate allied assets when engaging SDS. Suggest use of tactics that enhance preservation of Suns assets.

[Remonde is replaced by images of a Clan Wolf Overlord-C landing on an empty tarmac.]

[Remonde]: "When Khan Phelan Kell arrived, at the head of the FedSuns Group IV, the planetary governor provided his unconditional surrender before Kell and his forces even landed on the planet..."

[The video switches to a chaotic battle scene, a mixed collection of Inner Sphere and Clan units pushing in on white BattleMechs and vehicles in entrenched positions.]

[Remonde]: "The same could not be said for the Word's Achernar Protectorate Militia. Digging in deeply around the factory complex, the Word fought tenaciously against Coalition forces. When it was clear they could not stop Kell's coordinated assault, their final act of defiance was to destroy the factory while still inside it..."

[Remonde appears again looking over the unending field of debris.]

## LAST WORDS OF A LEGEND

## &gt;&gt;Profiler Interview File: 3077\_0613\_Rmckinnon&lt;&lt;

[Two people sit comfortably in facing chairs. The youngish woman is dressed conservatively, while facing her is fit man wearing AFFS undress. His blond hair mostly hides the gray in it.]

**[Aubrey White]:** "Welcome to the *Robinson Profiler*, I'm Aubrey White and with me today is Captain Ross McKinnon of the famous Fox's Teeth. Captain, thank you for coming."

**[Ross McKinnon]:** "My pleasure, Aubrey."

**[White]:** "I understand you're on Tikonov for refit after extended missions into the Protectorate. You've been raiding deep to the Protectorate for what, months?"

**[McKinnon]:** "Yes, something like that."

**[White]:** "In fact you've been away from the Suns for at least two years. Rumor has it you were at Odessa with Chandrasekhar Kurita's mercenaries. It's even rumored you were listed AWOL from the AFFS."

**[McKinnon]:** "Now, Aubrey, I can't comment on classified operations. But would I be working with the Suns' task force now if I were a wanted man?"

**[White]:** "Yes, of course. Coming back to your most recent mission, Marshal Sandoval-Ito has praised your command for the reconnaissance of Towne. You discovered a DropShip facility creating Pocket WarShips and heavy ground defenses?"

**[McKinnon]:** "Yes, the facility was well hidden but explains the influx of Word naval traffic in the region. The additional forces on planet were defending the plant and would have been a major surprise for the Marshal."

**[White]:** "Reportedly, you also disabled the ground-based space defense system, allowing the Suns' forces safe landing. But why was the *Indefatigable* still attacked when she arrived a week later?"

**[McKinnon]:** "We didn't realize the Blakists had two systems in place. They'd seeded the local asteroid field with drone SDS platforms that were only triggered by the passage of the *Indy*. Intel thinks they were specifically set to only go after JumpShip-sized craft, so the earlier forces went unmolested."

**[White]:** "I see; it is fortunate the WarShip was not part of the initial invasion then. So, I'm told your company will be..."

—Last public interview of Ross McKinnon, before his death during a raid on Hamal. *Robinson Profiler*, recorded 13 June 3077

**[Remonde]:** "Two companies of the Iron Guard and an unknown number of Word of Blake defenders died along with the workers of this once proud factory. The Coalition was victorious, but if this is any indication of the road ahead, this war will soon match the first liberation of Terra in cost of life."

—Peter Remonde, FSNS, Achernar, 8 July 3077

## SNAKES STILL SNAKES

(28 August 3077)

Hamal [BLADENSVILLE BEAT]: Even in the worst of times, it is a fool who clutches a viper to their breast. The citizens of the

## TERROR AT TIGRESS

Do you know what the greatest tragedy is from Sian being blasted from orbit? Sun-Tzu lived. If ever there was a time to wish the Blakist had done a better job, that was it. Maybe if they had succeeded, we wouldn't be mourning so many dead on Tigress. Stone talks about the evil of the Word and no one can deny that. But it is time to recognize the Capellan Confederation for what it is: a thug state willing to use whatever tools it sees fit to in order to win.

The nuclear annihilation of Talon, the assassination of George Hasek, and now using dirty bombs on Tigress! The Confederation is no nation state. It is a pool of resources for another mad Liao to pursue his twisted agenda. We can only bless the Unfinished Book that few of our brave men and women were killed in the terrorist attacks on Tigress. Whole cities lie under a pall of radioactive fallout and the Nova Cats' Delta Galaxy is burying more dead from Capellan betrayal than from Blakist guns.

It's time something is done about Sun-Tzu. He abandoned the Star League, shattered the Sarna March, betrayed his own people, and who knows what his next plans are? When we get to Terra, I say we take a hard left turn and make for Sian. Let's finish what the Blakists started and rid the universe of yet another Mad Liao.

—OpEd article appearing in *Salem Portage*, Salem, 29 June 3077

Federated Suns, and the citizens of Hamal in particular, have been asked by Devlin Stone and his cohorts to believe that the Snakes from the Draconis Combine have seen the light and changed their ways. Well, Mister Stone, I'm afraid history shows you to be a liar.

During the SLDF's original liberation of Terra from Amaris the Usurper, only the Draconis Combine fired on SLDF forces that were attempting to retake the Terran Hegemony. Perhaps the Federated Suns could have done more to support the Star League, but to actively fire on the SLDF was nothing short of treason against humanity.

And we will never forget Kentares IV. The Snakes showed their endless lust for blood on that world. Only true savages of the worst kind could initiate and sustain such a pointless slaughter. Only in the Draconis Combine would such genocide be called "warfare."

Today, the Snakes prove their true intentions once more. The Com Guards, who so selflessly blunted the original Clan invasion, have been bitten in the back by the treacherous on our own soil. An entire division of Com Guard troops were smashed under the heels of DCMS forces here, under the ludicrous claim that the Guards were really Blakist sympathizers.

We have seen the mettle of the Com Guards and the historical treachery of the Draconis Combine. We know who can be trusted, and who cannot. The savages of the DCMS can spew



**BHARAT ROADBLOCK**

**ORIGINATOR:** Colonel Jasmine Cross, AFFS Engineering Corps

**RE:** Engineering Tactics of the Word of Blake Assault on the Fox's Den

...the fortifications of Mount Davion proved the single most important part of New Avalon's siege. With the High Command able to operate even as Word forces secured all major surface fortifications. It proved a decisive factor in the multi-year defense...

...Of particular note were the following factors:

- Strategic placement of the facility within a dense mountain range.
- Brian-level armored structure. While not as capable as a true Castle Brian, this, combined with its placement deep inside Mount Davion, ensured the ability to withstand sustained orbital bombardments.
- All primary entrances built with interlocking reinforced endo-steel under ferro-carbide door structures, further reinforced by a ferrocrete façade.
- Multiple airlock-style entry systems. This prevented any interior damage, even while moving into or out of the Den as well as providing further reinforcement of door and tunnel structures near the surface.
- Overpressure baffling system which prevented pressure wave damage.

...It should be noted that the Word's final penetration of the Den was not a result of brute force, but a failure in communication and proper safety protocols on the part of the Den's defenders. When Colonel Jason Trent overrode the safety locks to allow both of Entrance 12's doors to open, reportedly to allow retreating AFFS units safety, he instead allowed the Word to drive into and through the outer tunnel systems. It was only from there that...

[Katheryn,

*For God's sake, read this report! We cannot take the Word's Bharat fortress with the forces we have. We don't just need more guns, we need experienced engineers, heavy equipment, and more time. We'll be reversing roles with the Word and be the forces chewed up and spit out. If we try and dig the Word out of there without the right planning, we will fail. —Walter]*

—Memo from Major General Walter White-Davion to Marshal Katheryn Sandoval-Ito prior to the commencement of the Bharat operation, 17 July 3077

whatever gibberish claims they will, but every Federated citizen knows the truth of the matter. Despite Devlin Stone's promises, or the "honor" of Kanrei Minamoto himself, a Snake will always be a snake...and should be treated and trusted as such.

**CLOSING THE CIRCLE****WAR TO THE KNIFE**

(14 October 3077)

Nanking [FSNS] — The Confederation has gone insane. That might sound like a Capellan March editorial, but in this case, it is an objective assessment as well. Both Coalition and Capellan forces reached the battered world of Nanking at virtually the same time, with FedSuns Group III ships arriving practically amid the Capellan fleet of JumpShips waiting at Nanking's nadir point. Both fleets arrived with the same goal: to liberate Nanking from the Blakists. And I have it on good account from sources near Devlin Stone that the Capellans agreed in 3076 that Chancellor Sun-Tzu would not interfere with Coalition efforts in this regard.

The CCAF units at Nanking did not pause to coordinate with Coalition forces. They did not share their intelligence. And they certainly did not cooperate with Coalition forces on the ground. What the CCAF forces—led by Warrior House Fujita—*did* do, was burn ahead at a punishing two-and-a-half gravities, the limit of their larger DropShips' acceleration, which cut their transit to two-thirds normal. Days at that G-load left their troops exhausted, out of shape, and suffering from a multitude of casualties: sprains, muscle tears, heart attacks, and more. Upon deployment, Fujita became the plaything of the Nanking Protectorate Militia, barely able to protect its own landing zone against determined Blakist counterattack.

After pushing hard at a more endurable one-and-a-half gravities, FedSuns Group III arrived roughly a day later and made a daring combat drop behind the Nanking PM's lines. The Blakists wilted under the harrying fire from the Seventeenth Benjamin Regulars and Clan Nova Cat's Delta Galaxy, before they ended up smashed under the weight of Fifth Lyran steel.

In thanks, House Fujita ordered the immediate departure of FedSuns Group III. Naturally, the Coalition commander refused because the last Blakists had not been run to ground. In response, House Fujita unleashed atomic weapons against the Fifth Lyran's base camp.

Coalition survivors departed Nanking, leaving the world and its Blakist-riddled government to the insanity of the Capellans, but this reporter doesn't know whether to pity the world below or the Confederation that now fights for it.

**INGRESS, FLETCHER FALL**

(3 December 3077)

Robinson [ROBINSON REGISTER] — The drive for Terra grows shorter and shorter. With the most recent victories, the FedSuns Thrust is nearly in striking distance of Terra itself. Early next year, we could see Marshal Sandoval-Ito start "Doolittle raids" against the system, even as the final Word-infested worlds are cleared out ahead of the final push. The road has not been without its trials. From the loss of the *Indefatigable* at Hean, to the death of legendary warrior Ross McKinnon, we have

## 3077: CLOSING THE CIRCLE



seen our troops bleed. And all too often, the Suns have faced challenges from within the Coalition, or at the very least from our technical “allies.”

Sandoval-Ito appointed Major General Walter White-Davion and his Fifth Crucis Lancers to the task of freeing Ingress. With David McKinnon now commanding, the Fox’s Teeth were pivotal in the near-bloodless victory. With such minimal resistance, Group I is already preparing for its next target world.

Fletcher likewise proved to be small challenge for the Federated Suns. With Conner Sortek leading the First Davion Guards, could one expect anything else? Working with the Com Guards’ Second Army, the Guards quickly outmaneuvered the Word’s forces. And with the Com Guard forces led by AFFS hero Galen Cox, the Second Army became practically an extension of the AFFS. Dealing damage well above what they received, the men and women of Group II crushed the Blakists and are already ready to push on.

It is hard not to hold up the Federated Suns drive as exemplary. Superior leadership, state of the art equipment, and a string of successes longer than any two other Coalition forces combined are stark proof of how much weight the Suns is pulling in this “Coalition” of equals.

**SANDOVAL-ITO: A STUDY IN SUCCESS**

(28 December 3077)

Robinson [ROBINSON REVIEW] — When the drive to liberate Terra began, the Federated Suns faced the longest road to mankind’s cradle. As the sun sets on 3077, the Suns has closed that gap to within a jump of Terra. Under the leadership of Marshal Katheryn Sandoval-Ito, over twenty worlds have been liberated by the Federated Suns. Some of these worlds have not known true freedom since Operation Guererro shattered the Sarna March twenty years ago.

Marshal Sandoval-Ito’s accomplishments stand up with First Prince Hanse Davion’s drive to end the Capellan threat in 3028. Not since that war have we seen such unprecedented success—and no First Prince has ever had to work under the limitations and conditions Marshal Sandoval-Ito has. Whether being forced to rescue one of Stone’s pet mercenaries on Yangtze, surviving the Capellan nuclear betrayals on Nanking and Tigress, or putting up with the fractious infighting of the other allies, Marshal Sandoval-Ito has risen to the task and beyond. Her strategic foresight allowed victories even in the face of the dogged defense of Bharat and can be thanked for the nearly bloodless victories on worlds like Ankaa, Woodstock and Small World. At the controls of her vintage *Devastator*, she led the critical tipping point in the victory on Achernar and was the first BattleMech to breach the Blakist fortress on Bharat.

Naturally, one can’t experience the kind of success she has without rivalries and jealousies swarming up like a pack of Clan Toads, but even the great Stone can’t argue with success. While

the other thrusts have covered a bare half-dozen worlds or a single jumps’ distance, Sandoval-Ito has led the Suns through a sixty-plus light year drive toward the heart of Terra. With one of Robinson’s ruling scions at the head of the Suns army, we will be waiting on Terra’s doorstep while the rest of the Coalition is still asking for directions.

**CAPELLAN FRONT****LIBERATION AT HAND**

(27 February 3077)

Algot [CBS] — It is with great pleasure that we can report that after many harrowing years, the people of Algot, Halloran V, and New Aragon have once again rejoined the Capellan Confederation. Our heroic *janshi* were successful in repelling the vile Blakist scourge from those worlds through great effort and heroism.

Celebrations are occurring on each of these worlds, and all citizens throughout the Confederation are encouraged to demonstrate their joy at this long-awaited victory in all appropriate fashions.

Word has reached us that all those who were Citizens prior to the occupation will have their Citizenship reinstated after proper review. Additionally, all non-Citizens who can prove their efforts in resisting the Word of Blake occupation will qualify for Citizenship.

With the liberation of Algot, we are once again reminded that we should be wary of the Davion scavengers. They emerged with a powerful fleet and massive army to take Algot from us, hoping to capitalize on a victory won with Capellan blood. Expecting an easy fight, they were swiftly dispatched when our naval forces intercepted their invasion fleet. They left the system in disarray.

**TRAVEL ADVISORY: ARBORIS**

(23 November 3076)

Arboris [SIAN HEADLINE REPORT] — Please be advised: All Capellans without business on Arboris are strongly encouraged to avoid travel to the planet. Several recent incidents have created an unstable situation that is being used by Blakist sympathizers to create unrest and hostility towards those seeking peaceful re-assimilation into the Confederation. These local difficulties have created a dangerous environment in which the Confederation cannot vouch for one’s safety. If travel to Arboris is unavoidable, please take all appropriate precautions. Blakist sympathizers have succeeded in agitating local law enforcement to a high degree, and their impartiality and neutrality is improbable.

Please continue to make donations to the Arboris Liberation Fund, as the proceeds have been very successful in aiding loyal Capellans on Arboris.



## 3077: CLOSING

The shameful “alliance” actions at Algot remind all loyal Capellans that the Davion is always eager to exploit weakness. The swiftness with which they pounced on Algot proves that they have spies in place seeking out signs of such weakness. Be vigilant always, and report any suspicious activity while we remain at war.

**WHAT WE SAW**

(18 March 3077)

New Avalon [FSNS] – Tonight we have an exclusive interview with Captain Harry Chevalle, owner of the independent merchant *Ponsatrain*. Captain Chevalle gives us the first eyewitness account of the rumored defense networks the Word of Blake has established around its so-called “Maginot Line” worlds. Chevalle was over Halloran V when the Capellan Confederation launched its attack on the world.

[The video image shows a gaunt-faced spacer. A voice speaks from off camera.]

**[Reporter]:** “You mean to say the Confederation’s premier WarShip, the *Franco Martell*, was taken out by satellites?”

**[Chevalle]:** “I’m not sure *what* I mean; I just know what I saw. Didn’t really pay much attention to them when I burned in. Man’s gotta eat, and Halloran always needs shipments of essentials. Wobbies or no, I was just making my deliveries.”

**[Reporter]:** “Paid attention to what?”

**[Chevalle]:** “Whole network of sats and some new orbital stations. Dozens of ‘em. Just didn’t pay no mind, I just followed Traffic Control’s orders. But then the CapCon showed up, all full-court press and dang if they didn’t all move in on the *Franco*.” [Chevalle waves his hand] “I know, I know, satellites don’t move, but these did. Were bigger too, but slow as an *Urbie* in quicksand. Was like watching a swarm of shark form, with the poor bastard Capellans in the middle. None of them could have been enough to more than annoy it, but when twenty or more of them start laying on with some kind of ship-killer missiles, well the *Franco* started bleeding air and tried to drop as close to the planet as she could. That’s when it was all over. Couple missiles rose out of the atmosphere and slammed right into it. Wasn’t much of the *Franco* left.”

**NO HOLDS BARRED**

(20 April 3077)

Genoa [CBS] – Sons and daughters of Genoa, rise up! Fellow citizens of Capella arise and throw off these oppressors who call themselves our betters, these Word of Blake tyrants who throw around nuclear fire against you as if it were but a child’s plaything! What evil is it that guides these monsters’ actions? How can they justify using nerve gas on a city merely to root out “suspected” terrorists?

They promised Blake’s justice, his light, his wisdom. All our people received was death.

## STONE: ANOTHER WORD FOR “BLAKE”

I’m Gordon Yang and welcome to *Enemies of the State*. Tonight’s enemy: Devlin Stone.

What do we know about this man, this Devlin Stone? He claims no past, no name, no allegiance to anyone but himself. We know he first came to prominence in a Word of Blake refugee camp. We have documented evidence that he comes from a family deeply involved in the Word. *Documented evidence* that he yet denies any recollections of! Oh, his supporters try to cover it up, but we all know the truth.

But let me ask you this: What is it the Word of Blake wants more than anything else? That’s right, to rule the Inner Sphere. Now, who stands in their way? That’s right, the Great Houses and their ruling dynasties. But the Word made a big mistake ten years ago: they tried to beat everyone into submission. And now it’s painfully clear that it’s just not going to work.

But you know what? The Word is sly. The Word is *sneaky*! These are the same folks who ran ROM for three hundred years. All that military action? Nothing but a big fake-out.

No, the real action is behind the scenes. ROM is running the show—and Devlin Stone is their front man!

Think about it! Intelligence agencies throughout history have been masters of deception and misdirection, right? What better way to misdirect everyone than to make it look like you’re losing? And at the same time slip your pawn into a Messiah position, so that everyone willingly falls in line behind him.

And watch as the fools follow him! Victor Davion. Adam Steiner. Hohiro Kurita (or should we say Kiyomori Minamoto?). Whichever Marik is in charge this week. *All* of them—even the Clans—are now falling at Stone’s feet and giving him their armies. Suckers. Mark my words: the day will come when they will all regret it. Someday, Stone will reveal his true colors and the Word of Blake will have won the long game.

Thank the heavens for Sun-Tzu Liao. At least the Celestial Wisdom sees Stone for the charlatan he is.

When we come back, more on Devlin Stone, including his surprising genetic connection to that archfiend, Hanse Davion. Right after this word from our sponsors!

—*Enemies of the State*, SBC, Sian, 19 April 3077

Well, we shall not lie down and die. Not now, not ever!

Rise up against them. Bring the fight to their very doorstep. Awake to the clarion call of our beloved Chancellor, his Celestial Wisdom, Sun-Tzu Liao, who will lead us to victory against these, our most hated foes. Come and join the fight! Make them pay for what they have done! They too must know the anguish and pain of losing everything they hold most dear! Give them not a moments rest! Make them fear the night! Instead, give them their Blessed Blake’s “peace” as they forced it on so many helpless Capellans!

## 3077: CLOSING

## WE STAND ALONE

"Citizens of the Confederation, I address you this evening both as your Chancellor and as a proud citizen and son of Capella. I wish to share with you how proud I am of the heroic sacrifices you have all made in the spirit of *Xin Sheng*. Our people have come together, in these, our darkest hours, as never before—putting aside petty differences and squabbles for the good of the Confederation at a time when other realms fall as wheat under a scythe. It is because of this strength and unity that the Confederation has stood against those oppose us.

"As many of you know, we are beset by enemies on many fronts. At this very hour, the brave men and women of the Confederation's armed forces battle heroically on many worlds, opposing the despotic armies of the Word of Blake and their misbegotten money soldiers. Against these tremendous—but not impossible—odds, we have liberated many worlds previously lost to us in body, if not spirit.

"However, once again, we—the Capellan people—find ourselves alone. Victor Davion and his puppet ally Devlin Stone continue to deny us any assistance in retaking imperiled worlds like Halloran V, Arboris, or Genoa from the common threat. Stone's forces have even attacked loyal Capellan troops on Nanking and Tigress as our brave soldiers fought to liberate their fellow citizens from the chains of their Blakist oppressors.

"This will not stand.

"We will liberate our brothers and sisters who have lived so long under the iron heel of enemy oppression. We do not need the help of this upstart Stone or his self-appointed 'Coalition.' We are the Capellan people. We can accomplish any goal. Through unity and strength of purpose we have overcome every obstacle set before us. Together, we will forge our *own* destiny.

"*Xin Sheng!*"

—Confederation-wide broadcast by Chancellor Sun-Tzu Liao, Sian, 20 April 3077

They wanted to subjugate the Capellan people, but they miscalculated. Now, we shall show them the error of their ways at the point of our swords.

We will resist these Blakists with every means at our disposal. If they bring a gun, then we shall bring a 'Mech! If they bring a 'Mech, then we shall bring a regiment! And if they use a nuke then we shall nuke them into the Stone Age and beyond because that is all they understand. Let us shove their "Peace of Blake" down their throats!

The Capellan people will never capitulate. We will fight on until our enemies are nothing but a scorched stretch of radioactive glass and our people are finally and forever reunited!

*Xin Sheng!*

## PLEIONE SURRENDERS

(23 May 3077)

Pleione [LPN] — One of the Blakists' major strongholds against the Confederation has finally been liberated! In crushing the final pocket of organized resistance here this morning, CCAF forces secured the world of Pleione at last. The campaign for this world dates back several years, since the start of the Blakist aggressions against the Capellan state. But once the Confederation devoted adequate resources to the problem, the Blakist defenses folded like a house of cards.

The lives of countless brave citizens were lost to attain this victory, but their sacrifice will never be forgotten. Plans exist for the creation of an appropriate monument in the Gina Fields, outside the planetary capital, where so many heroes of the state died bravely and honorably.

The Blakists' propensity of trickery and misdirection will leave lasting effects on Pleione. Even now, many on the world remain afflicted with the Word's deceptions, and struggle against their own liberators in pursuit of re-acquiring Blake's dominance. The Celestial Wisdom wishes it to be known that we, as a people, should consider it our duty to guide these wayward brethren away from their delusions not through violence, but through kind actions and righteous examples, reserving or wrath for the true deceivers, who must pay for their crimes against us. To that end, Capellans everywhere may rejoice in the state's resolve by witnessing the execution of Pleione's prime agitator, Joseph Larsus, the dictator who repressed our people during the Blakist oppression. This execution can be viewed—free of charge—at the LPN net-link [here](#).

## STONE'S TRUE COLORS

(22 April 3077)

Liao (CBS) – Perhaps Devlin Stone truly means to destroy the Word of Blake. Perhaps he will take this battle all the way to Terra, wiping out the white robed menace. Perhaps...

But he does not do this out of any heroic altruism. His words of a pan-Sphere alliance of equals are nothing more than the same drivel we have come to expect from New Avalon, Tharkad or even Atreus. The truth has become blindingly clear, as the "hero" shows his true colors.

Where was Stone's vaunted intelligence before the brave men and women of the *Franco Martell* were blasted from space, victims of an SDS network that the Lyrans had already encountered more than half a year before? When the Blakists sent an entire division of their cursed cyborg warriors to Halloran V, nearly crushing our forces, where was the vaunted Coalition? Is not Halloran V but a single jump from New Hessen, one of Stone's handpicked staging bases? Where was the Federated Suns, so-called powerhouse of the invasion? Not a single attack was launched by them in the entire month of April.

Stone may wish to see the Word of Blake destroyed, but it is clear that he is no friend to the Capellan people. Even the adage



## 3077: CLOSING THE CIRCLE

“the enemy of my enemy is my friend” may not apply to this new devil in fatigues.

—Sudrag Fang, Capellan Broadcasting Service, Liao, 22 April 3077

### DEATH ON A WHITE HORSE

(19 August 3077)

Ningpo [CBS] – My name is Quan Yin Chang, a reporter for Capellan Broadcasting. I’m here in a survival bunker inside Ningbo, capital of Ningpo. For the last two weeks, the Word of Blake’s Thirteenth Division and CCAF forces focused their fight here. The liberal use of tactical nuclear and chemical weapons has all but obliterated the city, leaving most of the population dead, wounded, or missing.

The Thirteenth Division made a combat drop on 3 August, fifty kilometers south of Ningbo. The Home Guard forces moved into a blocking position while Warrior House Ma-Tsu Kai maneuvered to strike at the Blakists’ flanks. The ensuing conventional battle destroyed the production plant and much of the surrounding towns. The Home Guard grudgingly gave ground as Ma-Tsu Kai harried the enemy flanks.

The battle turned ugly when the Blakists fired the first WMD. Ma-Tsu Kai suffered serious casualties, but responded in kind, decimating one of the Thirteenth’s level IIIs. Still, the Blakists forced the defenders back into the city. Each side fired numerous WMD’s—including chemical and nuclear weapons. They leveled Ningbo in an attempt to destroy one another. Out of options, Ma-Tsu Kai launched a desperate suicidal attack against the Blakist position. While this proved successful, House Ma-Tsu Kai paid a terrible toll. The timely arrival of House Ijori kept the remnants of Ningbo from falling, and the surviving Blakists made an orderly retreat. But then, upon liftoff, the enemy DropShips coordinated a concentrated strafing maneuver against Ijori’s troops before making orbit. House Ijori suffered horrendous losses.

I must sign off to get this recording off world. Whoever gets this report, please play this so others will know the horror Ningpo has suffered....

### VULTURES CIRCLING

(30 September 3077)

Nanking [CBS] — In the long list of Davion duplicity, Nanking now has regrettably found a place. The CCAF was preparing to invade Nanking and remove the Blakist taint when a repeat of Algot occurred. A powerful Davion fleet arrived. Apparently learning from their prior mistake, they claimed to be a part of “Stone’s Coalition”, intent on liberating the world for their own purposes. They played at words and maneuvers, but their actions—as always—revealed their true nature. The Federated forces did nothing to support the CCAF efforts on Nanking. And because of their neglect, House Fujita was left to face an ignoble death at the hands of the Word of Blake zealots.

Not content to let Capellans bleed needlessly, the Davion forces took advantage of Fujita’s misfortunes to stake their own claim over the world. But our brave warriors did not let this stand without a fight. Landing troops on Nanking, the CCAF turned upon this new threat to our people’s sovereignty, and through extraordinary measures, succeeded in ejecting the invaders from our reclaimed lands. Our enemies—new and old—paid dearly for their affronts.

The lessons of Algot and Nanking prove that the Davions are like carrion birds, eagerly awaiting any sign of weakness so they may swoop down and claim the prize for themselves.

Perhaps worse still is the evidence that this encounter brings concerning Stone’s alliance. Given his prior promises and commitments, his refusal to yield Capellan worlds, and apparent consent to let his Davion dogs maraud as they please, we now know that we cannot rely on anything but for Stone to behave like any other Davion-bred cur. His “Allied Coalition” caters to the spawn of Davion and Steiner, and to anyone else who is content to kiss his boots. This state of affairs is regrettable, but wholly unsurprising from a man most likely born of FedSuns parents. Thus, we remain vigilant against the vultures circling overhead.

### PUBLIC ENEMY

(14 December 3077)

Sian [VNN] – While some conspiracy theorists would have you believe sensationalist evidence, naming Devlin Stone as an agent of the Word of Blake, Victoria News prefers to pursue the path of legitimate reporting and bring to you the truth of “Devil” Stone.

Stone is nothing more than a carefully crafted creation of Victor Steiner-Davion! While no one can fault the pocket warrior’s martial ability, his ability to actually *lead* anything more than a small force in battle has forever been sullied by his continued failures to actually rule nations. But the son of the Fox is not the complete political failure he would continue to have us all believe. Like any wounded predator (wounded pride, in the case of the Davion Napoleon), he has learned and adapted.

Stone is just one example of the Fox-let’s machinations. With the simple application of Davion pounds to disaffected warriors, in the Suns’ bloated military structure, this reporter uncovered the truth of Devlin Stone’s background—a truth that *proves* Stone is but a puppet of Victor Davion and it is the former “Archon Prince” who is manipulating this entire war. With more evidence uncovered from outcast Word of Blake agents, the truth is revealed that this entire conflict—the whole “Jihad” has been nothing more than a Steiner-Davion plot to seize control of Terra and declare Victor or his puppet, Stone, First Lord over us all.

It would be irresponsible of me, as a loyal daughter of the Confederation, to not provide this evidence to the Chancellor and the brave men and women of the Maskirovka. I thus have provided all my files to the Chancellor’s representatives, knowing they will use this knowledge to ensure we remain free of this would-be despot. Know, my faithful readers, that this evidence is the damning nail in our hated foe’s heart.

## 3077: CLOSING THE CIRCLE



## LEAGUE FRONT

### ANYONE BETTER?

(2 January 3077)

Tamarind [TDN] – That a native commander would be selected to head Marik-based operations of Stone’s Coalition isn’t too surprising, but choice of commander—Duchess Alys Rousset-Marik—has been met with some skepticism. Though an able guerrilla fighter and political scrapper, her strategic experience is limited.

Of course, the fractious nature of League politics rules out many with more relevant political and military experience—such as Christopher Halas, Selim Halas, or Albrecht Kiel. More politically neutral, Duke Leonard Stewart has both the authority and experience, but his gruff demeanor and lack of the diplomatic expertise to hold together a multi-national coalition has relegated him to leadership of a single battle group within the Marik-Coalition command. Both of our own Brett-Marik brothers could have provided the necessary leadership and done justice to their father’s memory. (Duke Jeremy would have been the stand-out choice to head the force had he not been targeted by Blakist assassins early in the war). However, Duke Photon is enmeshed in defending Tamarind against external threats while his brother Reginald seems happy to play second fiddle to their cousin.

So in some regards, Alys can be seen to be a compromise candidate, one willing to put aside the good of her immediate responsibilities in favor of the larger goal. Her political efforts with the Great Debate and—early in the war—communications with both Tamarind and Atreus established her *bona fides* as an “honest broker” and her recent broadcast to the entire League made clear her desire for the entire state to work with Stone’s Coalition. Her acceptance of her own limitations and willingness to seek advice from others such as Duke Reginald has endeared her to the masses.

But it still remains to be seen if she can justify that faith.

### WASAT FALLS

*[Video reveals a large man in black Elemental armor with a blue star field covering the chest standing next to a diminutive reporter wearing khaki clothes, flak vest and combat helmet. The Elemental’s faceplate is open.]*

**[Anchor’s voice]:** *[Off camera]* “In keeping with our continuous coverage of the Liberation of Wasat, we are going live to the field where INN’s own Nigel Holmgren is conducting an interview with Khan Santin West, leader of Clan Nova Cat and second-in-command of the allied Coalition’s League Thrust.” *[Live link cuts to Holmgren standing to the right of West]*

**[Holmgren]:** “Khan West, I appreciate you giving me the opportunity to speak with you, sir.”

**[West]:** “You are most welcome, Nigel. Though my schedule is somewhat pressed, I am more than happy to help you in your pursuit of information.”

**[Holmgren]:** “Yes, um...sir, can you tell me your impression of sequence of events that led to your stunning victory here?”

**[West]:** “*Aff.* We found the defenses more intricate and stronger than anticipated. As such, it cost the command half its combined strength. When whole companies are lost, the on-ground commander has a serious problem. Such was the situation facing the Seventh Pesht...”

**[Holmgren]:** “Pardon me, Khan West, this is new information I hadn’t...”

**[West]:** *[ignoring the interruption]* “...so after learning that General Stewart found himself in a bind, I diverted Third Group to Wasat to help reinforce and secure victory. My own Alpha Galaxy spearheaded the assault, with the Com Guard Fourth Army and the Twentieth Marik in support. The Wasat defenders attempted to refuse their flanks, but they were unable to sustain any type of coordinated defense against the Second and Third Group’s simultaneous assaults. We completely eradicated the *surats.*”

**[Holmgren]:** “I see. Can you say where your forces will go next after clean-up operations are completed?”

**[West]:** “Well, that is classified, Nigel. I must return to my command. I enjoyed our chat; we must do this again.”

**[Holmgren]:** “Agreed, sir. And thank you for your candor and openness.”

—INN interview, broadcast by local news outlets on Wasat, 4 March 3077

### TOO MUCH TO HANDLE?

(30 April 3077)

Oriente [LNN] – While we would never imply that they should have sent a man to do the job, we can certainly say that they should have at least sent a real soldier to do the job. Four months into the pan-Sphere offensive against the Word of Blake Protectorate and the troops under Duchess Alys Rousset-Marik have liberated only two worlds, raided a third, and suffered horrendous losses. If it were not for the Nova Cats, even those gains might have proved unattainable to the plucky Duchess.

Apparently when the chips are down, Alys plays hide and seek. While her famous guerrilla tactics of the last decade worked well to nip at the Word’s heels, it’s not going to win an all-out offensive against an entrenched opponent. In just the first week of her assault on Wasat, the Home Guard was shattered and capital-scale ground emplacements vaporized a company of the Seventh Pesht Regulars. Seems like *someone* failed to do their homework on the Blakist defenses. Bloodied, and with apparently no real strategy, Alys took her forces to ground. For the next two months, the Word chased her around the planet while she waited for rescue. It came in late February, when Santin West led the rest of the League task force to bail her out. After

## ZION FREED

**Security Protocol:** Tango Sierra  
Uniform Omega Prime///Eyes Only  
**Date/Time:** 031677—2325 Zulu Local—  
Zion

**To:** Precentor Lucifer  
**From:** Poltergeist-Delta Leslie  
*Terra Domini, I have located Colonel Stryker. He is on Zion. Here is an excerpt of the news report from Zion's Independent Press:*

>>>**Begin Report**<<<

Today is my first report free of the Blakist regime. I can gladly report as of today, 15 March 3077, Zion is finally free of the tyranny of the Word of Blake. All Zions owe their thanks to the Blackhearts.

Reportedly, the Blackhearts secretly landed on Zion in late 3069—their movements unknown to even the Word of Blake ROM. The entire command then spent the last eight years secretly rebuilding in the world's hinterlands, recuperating from their two-year ordeal against the Third Division and their mercenary allies on Wasat.

Though only recently confirmed, the Blackhearts were able to infiltrate various levels of the local government and other strategic areas throughout the world, collecting intelligence. Additionally, the Blackhearts' own special operations forces recruited and trained from the local populace, creating specialized insurgent units that could operate independently against the Blakists and their collaborators.

After building their network, the Blackhearts' commander, Colonel Glen Stryker, commenced systematic operations to destroy the Word of Blake's administration and dismantle local defenses. Within two months, the Blackhearts and Zion insurgents successfully forced the Word and its collaborators to retreat. Those Blakists who failed to escape were captured and summarily executed. No mercy was shown to any troops or sympathizers.

I spoke with Colonel Stryker briefly

amid the local victory celebrations in the capital city of Beersheba. When I asked him what his plans were for Zion, he responded that he still considered his Blackhearts to be under contract with the Free Worlds League and that his plans were to link up with Duchess Alys Rousset-Marik's command. For the people of Zion, he added, 'You have your own trained and equipped defense force now.'

Though the Blakist war may continue, for now, Zion is free from the horrors of the war—if only for the moment.

>>>**Report Ends**<<<

I have a vid-recording of Stryker and a "lifelong friend" he calls "Grevista da Tempestade." With your permission, I will terminate him and Colonel Stryker.

**[Message Reply: Do nothing. We have plans in motion.]**

—Message allegedly discovered in Epsilon Eridani HPG datastore (veracity unconfirmed)

saving the Duchess' bacon, West took Alys and the entire League command on to Acubens.

With April fast ending, the League thrust has secured only two worlds. The Combine has already liberated thrice that and conducted a half a dozen raids. This reporter has to ask, is Alys up to the task or will Stone be three years on Terra before she finds her way there? Never thought I'd be wishing a Clanner was in charge.

### OVERVIEW: ALYS MARIK

I'm not allowed to tell you our current location or disposition, but I can say that Operation: SCOUR is underway and the fighting has been joined on several Blake-held League worlds.

Duchess Alys Rousset-Marik is in overall command of the League end of the operation, with Khan Santin West of the Nova Cats as her XO and Duke Leonard Stewart, ComStar Precentor Harris Harvison and Lieutenant-General Paul Zardetto all acting as sub-commanders. Steadfast League troops are scattered throughout the battle groups, with a strange mixture of Clan, ComStar, Combine, Lyran, FedSuns and even mercenary troops filling out the numbers.

The overconfidence of the Seventh Pesht Regulars has bordered on arrogance, with only the valiant effort of the Home Guard holding Group II together as the campaign pressures threatened both the ComStar Fifth Army and the mercenary Devil's Brigade.

Representing the LAAF, the Seventh Donegal and Third Lyran Guards are solid fighters, but their interests seem at odds with those of the League troops. The Davion contribution is

minimal—the Marlette Crucis March Militia—providing a force that's probably good for little more than garrison duty.

And then we have the Clans. The tardy response of Khan West in bringing Group III to Wasat brings the commitment of the Nova Cats into question. By all accounts, the Twentieth Marik Militia were ready and willing to jump but were forced to wait on their Alpha Galaxy and ComStar Fourth Army comrades. Meanwhile, the Hell's Horses' Eleventh Mechanized Cavalry matches the Seventh Pesht for arrogance, but next to them, saKhan Daryl Kerensky's Exiled Wolf Beta Galaxy makes even the Horses look laid-back. Can they deliver in a real fight, or—like many of the so-called Children of Kerensky—can they only talk a good fight and fold when the going gets tough?

As the old saying goes, times of adversity make for strange bedfellows and controlling this motley assortment of troops will prove a real challenge to the Duchess.

—Nigel Holmgren, embedded INN reporter with the League Thrust, 17 March 3077

### TALITHA, BERENSON CAPITULATE

(28 May 3077)

Berenson [FWAP] – The Free Worlds' push into the Blakist-controlled Protectorate surged forward with two decisive victories in the month of May. With the power of the exiled Wolves' Beta Galaxy at their core, League Group IV rolled over the defenders of Talitha in record time. Backed by the Nova Cat WarShip *Blade*, they made short work of the defenders after quickly achieving total aerospace supremacy. Group IV has shown remarkable inter-

## SLAUGHTER ON STEWART

"Good evening, folks. I'm Kristina Greenberg. Two days ago, at local dawn, an invasion force later identified as Clan Nova Cat's Alpha Galaxy, landed here on Stewart and deployed the First Nova Cat Guards outside of New Edinburgh. Afterwards, a Star Colonel Calvin Rosse sent a communiqué to the planetary government, demanding the unconditional surrender of the planet—and all Blakist forces and collaborators—to the "allied Coalition." A deadline of only two hours was given to comply.

Reportedly, the Stewart militia defense forces, including a company of BattleMechs with a small detachment of infantry and light armored vehicles, marshaled and marched out to meet the Nova Cats. While KNES has no footage of the brief battle, we have received this recorded exchange between the combatants.

**[Star Colonel Rosse]:** "Blakist commander, state your intent. Are you here to surrender?"

**[PM Captain Jonathan Wells]:** "Surrender? Not bloody likely, mate."

**[Rosse]:** "Is this your final answer, *quiaff?*"

**[Wells]:** "Yeah, that's my final answer."

**[Rosse]:** "Then so be it."

**[Wells]:** "Are we to fight honor duel—"

**[Rosse]:** *[Interrupting]* "Neg! You and your Word of Blake do not deserve the honor of *zellbrigen!* This is a Trial of Annihilation. Your fate is sealed."

**[Wells]:** "What the *[censored]*!"

The battle lasted less than two hours. When it was over, every man and woman in the Protectorate Militia force lay dead. True to the terms of the Clan "Trial of Annihilation," the Nova Cats slaughtered even those who tried to surrender.

As news spread of this horror, citizens across Stewart rallied against the Clan invaders. Reportedly, several brave—but reckless—citizens commandeered a number of Planetlifter cargo planes, filled them with explosives, and attempted to fly them into the invaders' DropShips. Only one of these desperate attacks succeeded, severely damaging a large cargo DropShip and forcing the Cats into a defensive position, slaughtering anyone who dares to wander into weapon range.

Today, a tenuous peace remains in place around the enemy's landing zone forces while planetary and Protectorate officials scramble to reinforce the local defenses against further aggressions. KNES News promises to keep you all informed of any new developments in this startling event.

For KNES News, I'm Kristina Greenberg.

—Broadcast by KNES Channel 11 (a Voice of Truth affiliate), Stewart, 28 May 3077

coordination for a multi-national attack force, with the Third Lyran Guards and Marlette Crucis March Militia working closely with the Phelan's Wolves. Properly used, this group will be a deadly sword to match the Word's own weapons.

## CLOSING THE CIRCLE

Berenson nearly turned into another Wasat for Duchess Alys, but the capable commander quickly adapted to the heavier-than-expected defenses found there. Withdrawing to space and the cover of Clan vessels, Alys waited for League Group II to arrive and reinforce her Group I. Together, the massed force renewed their attack and was able to roll over the Berenson defenders in little less than a week's time. What began as a slow start to the League offensive has quickly made up for lost time and numbers, claiming significant salvage from both of these key victories. With Group III expected to hit its next target shortly, the offensive will continue even as the remaining three task groups take a brief rest and refit.

When the League front moves once more, the Word of Blake will find that this well-supplied force has quickly forged itself into a highly effective and coordinated command.

## IS TITUS CAPABLE?

(29 May 3077)

Regulus [RCN] – With the campaign on Vosloorus entering its third week, questions are being asked as to whether or not Prince Titus is truly up to the task of leading his nation through these troubled times. What was initially seen as act of aggressive posturing has turned deadly with the arrival of the Second Marik Militia to the world, and pundits are concerned that the prince is quickly getting Regulus bogged down by a conflict that could threaten the entire Principality.

Whilst onworld combat has been remarkably restrained, analysts wonder how long the prince's forces will maintain their controlled strategy of feint and counter-feint, especially after news of the horrific deaths of the prince's wife and unborn child broke a fortnight ago. One unnamed officer speaking on the proviso of anonymity had this to say:

"It's not that we don't trust Titus; contrary to popular belief, the troops have a lot of faith in the man. But this campaign has no focus—it hasn't had it from the start. We've been given nebulous orders from the beginning. No strategic objectives other than to minimize casualties, and not expand the conflict. That's all well and good, but someone forgot to tell the Militia. If the Thunder hadn't pulled off their end run, we could have been forced off world in days. Now, with the princess dying...well, I wouldn't blame the prince if he stepped down from command of this op. Let it be run right."

Particularly vocal are those supporters of former prince Kirc, whose leadership and strategic acumen, they claim, have been sorely missed in this latest military adventure. Their argument that Titus' attention has been irrevocably turned towards his wife's funeral and his own grief has found increased weight amongst a populace tired of war, and also grieving for the loss of the popular Princess Michelle. Perhaps a return of the elder Cameron-Jones is the shot of stability our troubled realm needs.



## MISTAKEN IDENTITY

**[Nigel Holmgren]:** "This is Nigel Holmgren reporting from Kalidasa. Just yesterday, this world was officially liberated when elements from League Group III made their landings at the capital city. Once there they linked up with the planet's resistance fighters, the Bard's Champions. It is my distinct pleasure to introduce their leader, Commander Edith Byers."

**[Edith Byers]:** "Thank you for having me. I look forward to sharing my tales, such that it may act as a warning or as comfort to those who suffer equally."

**[Holmgren]:** "Yes, well said. First off, could you explain the meaning of your nickname, the 'Kalidasa Ghost'?"

**[Byers]:** "The name carries several meanings, as it was one given to me by my charges, and confirmed by my enemies. In the combative sense it refers to my insistence on fading before the enemy can grab hold of me and mine. I aim to be vaporous, like fog, intangible. I also seek to be aware and observant without being observed, much like a ghost might. In other ways, it refers to the origin of our world's name, the Great Poet Kalidasa. It is something to aspire to, and with it my charges have pushed me to great prominence by ever seeking more."

**[Holmgren]:** "And how are you enjoying your new-found freedom?"

**[Byers]:** "We are *always* free. That is an important distinction to make, although I understand you refer to freedom from the Word of Blake. It is true that it is a relief to be without their corrupting and harmful occupation. We *have* suffered. I only regret that the moment of triumph had to be marred by my own lack of wisdom."

**[Holmgren]:** "Ah yes, you refer to the momentary confusion after the landing of the Com Guard's Fourth Army? I presume you had no choice but to assume the Word had returned with a garrison to re-conquer Kalidasa."

**[Byers]:** "A measure of choice exists in every circumstance, but yes, we were confused, and fear clouded our judgment. We—"

**[Holmgren]:** "Such confusion obviously exists in any war, especially this one, where we fight masters of deception."

**[Byers]:** "And not all of them wear robes, or attack you with BattleMechs, it seems."

**[Holmgren]:** "Indeed! So now that the momentary confusion is behind us, Kalidasa has a bright future ahead of it!"

**[Byers]:** "You do not understand."

**[Holmgren]:** "Thank you for your time."

**[Byers]:** "May wisdom find you."

—INN newscast, Kalidasa, 18 July 3077

## THIRD GUARDS DEFECT

(15 July 3077)

Regulus [RFP] – The Third Free Worlds Guards arrived on Regulus today to pledge their loyalty to the Principality. While

## AND SO I DECLARE...

"It is fitting that I stand before you all—soldiers, dignitaries and journalists alike—in this place of history and martial presence. What I have to say today is about history... about the history of our nation, and not just the nation of the Regulus, but the greater Free Worlds as a whole.

"The *Free Worlds*. I ask you to consider those words. *Free worlds*. Certain people have criticized my actions in the so-called Regular Free State, claiming that I am warmongering in an effort to assuage both my grief and my feelings of inadequacy when compared to my late father. That was never my intention. I could simply not stand back and watch as Regulars—*wherever* they may be—were made to cower and beg for protection from those that would harm them *from* those that would harm them. I could not stand by and let our people fear to be free.

"I deeply regret the loss of life on both sides. I truly do. But the actions of our neighbors have shown that they have no such qualms, and that the freedom of the *Free Worlds League* is but a sham. How can I sit idly by when our neighbors oppress our own countrymen? How could I turn a deaf ear to those very people who cry out for the freedom that the people of Regulus know and enjoy?

"I said before this is about history. Historically, Regulus has been a powerful force for change in the League, and I mean to maintain that tradition. Change for the better.

"And so I declare my claim for the Captain-Generalcy of the Free Worlds League. If our neighbors choose to conspire with monsters, then they have relinquished their rights to lead the people of our great nation. And if they choose to oppose us, then we will face them with the full force and fury that only those who are truly committed to justice can muster."

—Partial transcript of Prince Titus Cameron-Jones' *Address to the Principality*, 22 September 3077

certainly the arrival of the Third Guards could provide a welcome boost to our fledgling military arsenal, unnamed sources within the Regular High Command have raised the issue of these troops' true motivations and allegiance.

As recently as May, the Third Guards were actively involved in combat operations on behalf of the Word of Blake. Unconfirmed reports have placed them in the Wing system, which was seized by forces under the command of Devlin Stone's allied Coalition despite a very spirited defense. Heavily damaged, and reportedly left without support by the Word of Blake, it appears the Third simply returned to Free Worlds League space in an effort to find a new home.

"We'd be foolish to ignore the possibility that this so-called 'defection' was, in fact, an attempt by the Word of Blake to establish an operational force within the Principality," General Thomas Orfelt commented. "But by the same token, we would

## CHARA, DAMOCLES AND TRUST

[Vid-screen begins promo with music]

**[Announcer]:** "And now, *Inner Sphere Conspiracies: Truth or Myth*, with your host, Viktor Chandler."

[Applause; video reveals a middle-aged, balding and overweight man dressed in a fine-cut, stylish suit and sporting an oiled Vandyke beard cut to a point. He sits at the head of a semi-circle table with two women and a man.]

**[Chandler]:** "Welcome back to another edition of *Inner Sphere Conspiracies: Truth or Myth*. Today is September 27, and I'm Viktor Chandler. Tonight, we have a special panel to discuss a number of topics. Topping the list: the disastrous events on Chara, the mysterious 'Damocles,' and trusting vigilante rogue agents."

[Chandler turns to his right, addressing a brutish woman dressed in paramilitary styled clothes.]

**[Chandler]:** "Tracy Melbourne, welcome back. Can you tell me what you know of the events on Chara?"

**[Melbourne]:** "Thank you Viktor, it's good to be back. Yes, I can. As you know, Duchess Alys Rousset-Marik's forces are spearheading the assault against the Blakist Protectorate." [Voices from the table murmur their assent.] "Reportedly, the intelligence came from a former Blake's Wrath agent, known only as 'Damocles.' According to my sources, Chara's intelligence was counterfeited. This info led a Wolf-in-Exile force into a deathtrap, costing enormous casualties. Therefore, I believe Damocles is a Blakist double agent."

**[Chandler]:** "Stunning!" [Turning to another panel member dressed in a black leather jumpsuit, fair skinned man wearing gothic make-up and flame red hair.] "Antoine Schlessinger, it's nice to see you again. What do your sources tell you?"

**[Schlessinger]:** "Thanks, Viktor. My sources confirm what Tracy stated. Additionally, the system had an active SDS system and Caspar drones that destroyed a number of major WarShips."

**[Chandler]:** "Caspar drones? Like the old Star League network?"

**[Schlessinger]:** "Exactly, I—"

**[Jessica Cynella]:** "Pardon me, Viktor, if I may?" [Viktor nods his ascent toward the young, dark-skinned blonde clad in a plain blue blouse and dark slacks] "I have conclusive evidence of who this Damocles is. What he is *not*, however, is a double agent. Of that I am sure."

**[Chandler]:** "Well, Jessica, we're all ears. Who is this Damocles?"

**[Cynella]:** "He's a ROM agent who went rogue just before the start of the Jihad—former Precentor Tempest Stryker."

**[Melbourne]:** "And you say that proves him *innocent*? What hallucinogenics are you *on*, woman? You want us to say he's not a double, just because he went rogue before the war? Care to share your 'conclusive evidence'?"

**[Chandler]:** "We'll do that and more, right after the break."

be equally foolish to turn our backs on our countrymen if they truly have seen the error of their ways and wish to return to their homes and families."

Regulus has suffered numerous atrocities and attacks of the past few years, most of it the work of Blakist duplicity. We have suffered firsthand the Word's cruelty, and have become a political tool for the whims of power-mad dictators. We have been forced to forge our own nation from the ashes of the Free Worlds League itself.

Only now have we begun to return our lives to a semblance of normalcy. The rebuilding of the military and infrastructure sits at a fragile crossroads. Regulus may have little choice but to accept the defection of the Third Guards at face value. But even so, these newly "loyal" forces should be watched with great care and attention.

## CHARA OPERATIONAL REPORT

**To:** Khan Kell

**From:** Acting Galaxy Commander Alexia Rhyde

**Topic:** Chara After Action Report

My Khan, I have grave news to report. Our intelligence was compromised and we were unsupported during our attack on Chara. We have suffered many losses, but none, I fear, will be harder for you to take than that of Ranna Kerensky. I know you have adopted our ways, but your relationship is still not a typical one among our people. I hope you can find a way past your grief, for Chara was a major setback.

During the initial incursion, we lost the *Werewolf* and the *Fylgia*. The Cats also lost one of their *Carracks*. The Blakists unveiled an SDS system here that employs nuclear weapons. 'Damocles' did not inform us of this, nor was he apparently aware that in addition to the Militia, three regiments of former Free Worlders awaited us: the Fourth Free World Legionnaires, the Thirteenth Marik Militia, and the Steel Guard.

Upon landing, our warriors fought well, but it was not enough. The sheer weight of the opposition was too great for us to overcome. The Second Legion engaged the Guard, while the Sixteenth hit the Legionnaires. The rest of the Galaxy pressed on the two Militia units, but was unable to punch through the enemy line. The Legionnaires wore down the Sixteenth and we could not hold. We inflicted grave damage upon them, but were ultimately forced to retreat. Star Colonel Ranna was felled by a Blakist shot to her cockpit. We were unable to retrieve her body, just as we were unable to recover many of our fallen comrades.

Due to the loss of our commander, our retreat was hastier than expected. We have pulled back to Talitha,

**3077: CLOSING THE CIRCLE**

but were forced to leave much equipment and supplies behind. We will await further word from you or Alys Rousset-Marik.

—Clan Wolf (in-Exile) missive, dated 17 October 3077 (veracity confirmed)

**A TRAITOR WITHIN?**

(22 November 3077)

Marik [ISNS] — The position of the Marik Commonwealth is precarious, indeed. Corinne Marik, seeking to safeguard her people while not resisting the Blakist mandate, has enjoyed only limited success in this regard, particularly with her father Paul's obvious pro-Blakist leanings. And with the Word clearly on the defensive after Stone's Operation SCOUR, Atreus' position is becoming difficult. Nevertheless, rumors have begun to circulate in the capital of an "accommodation" with the allied Coalition. Few hard facts exist, but it appears an agent known by the codename *Albatross* (believed to be Alys Rousset-Marik's aide-de-camp Daniel Schulz) has held a series of meetings with representatives of Captain-General Corinne Marik.

Given the Blakist presence on Atreus, the secrecy behind such meetings (even here on Marik) is understandable. Is Stone—through Alys and her agents—working out some deal to dislodge the Blakists from the Commonwealth? Or is some form of non-aggression pact being hashed out to allow the Coalition a free hand around Terra? Wilder rumors speculate that in return for ejecting the Word from the Marik Commonwealth, Stone's Coalition will provide military and political assistance to Corinne to enable the reconstitution of the Free Worlds League (presumably after capturing Terra). Even less credible are suggestions that because of the Commonwealth's internal politics, Corinne will step down in favor of another of Janos Marik's descendants, clearing the way for a new leader, free of the Blakist taint. Isis Marik and Alys Rousset-Marik have been advanced as the most likely candidates, but with Isis' marriage to Victor Steiner-Davion and Alys' ties to Stone's allied Coalition would either be welcome on Atreus?

Whatever the case, it seems the Word's hold over the Commonwealth may be on its last legs. It remains to be seen if they go out with a whimper or a bang.

**ATREUS DARKENED**

(11 December 3077)

Regulus [RBN] — With the arrival of Alys Rousset-Marik's so-called "resistance" forces in the skies above Atreus, all news to and from the former League capital has been lost. Immediately prior to Alys' arrival, there were reports of sustained firefights on the ground. Whilst optimists may point to this as evidence that faux Captain-General Corinne Marik has finally turned against her Blakist masters, history would suggest this is simply the latest in a series of atrocities carried out on the capital.

One RDF analyst put forward the notion that it was an attempt by Corinne Marik's forces to avoid a repeat of the false Thomas Marik's abortive rescue attempt to rescue his family from the previous year. With the arrival of Alys' forces, the suggestion is that Blake and Commonwealth forces engaged in a series of raids to prevent any on-world resistance from meeting up with the arriving units. "They don't want any repeats of last time; public unrest swelled dramatically when the fighting tore through the Botanic Gardens. This is simply a counter-insurgency campaign kicked into overdrive with the arrival of additional units," commented one anonymous official.

The other option seems much less likely: That Commonwealth forces are actively engaging Word of Blake forces on-world. "With the almost interlinked command structures that the two factions share, it seems unlikely that any sort of attempt would be localized, instead it would be planetwide. Of course, we may have only seen the very beginnings of a *coup d'état*, but the timing with Alys' forces arrival seems too coincidental in that case."

Ultimately, until the blackout surrounding the capital is lifted, we have no way of knowing whether Alys Rousset is a harbinger of freedom for Atreus, or its angel of destruction.

**HEIR TO NO THRONE**

(19 December 3077)

Atreus [ISNS] — It appears the rumored *entente* between the Coalition and Commonwealth has collapsed in the bloody wake of the Word's ejection from Atreus. The battle for the League's capital, which saw profligate use of nuclear weapons against orbital traffic, was costly to both the Commonwealth and Coalition alike, and the fallout—both real and figurative—has done little to improve relationships between the branches of the Marik family.

"Free of the Blakist yoke, my cousin now wishes to attach conditions to the accord reached in good faith with the Coalition," claimed the Duchess of Augustine, whose tone showed little sign of the warmth and closeness the cousins enjoyed prior to the Jihad. "Instead, she sought to pay the blood-price of her father's treachery with the proceeds of another betrayal."

More revelations were to come from her Ladyship.

"At the heart of our accord were that Paul Marik and his associates would be tried by a war crimes tribunal, and that the Captain-General would herself stand down pending parliamentary elections. On the former, my uncle is presently at liberty and Corinne has expressed her unwillingness to hand him over to the Coalition. On the latter point, she further refused to accept Parliament as a neutral arbiter and would only step down in favor of a successor of her choosing: Me."

The announcement brought pandemonium in the cabin but Duchess Rousset-Marik quickly quieted the gathered journalists. "I have declined. I will be heir to no throne. In offering the post to me, Corinne has demonstrated how little of the situation

## 3077: CLOSING THE CIRCLE



she understands. Consequently, I am returning to Augustine to resume Coalition operations against the Blakist Protectorate. The people of the Commonwealth will decide matters here."

Corinne Marik could not be reached for comment but a source close to the Captain-General stated, "We do not bow to petty tyrants, even when they clad themselves as liberators."

## AND IN OTHER NEWS...

### DE LA SANGRE: MISSING?

(15 January 3077)

Demeter [DDN] — It has now been five days since Governor Giovanni Estrella de la Sangre was last seen in public, and his office has released a statement today indicating he is currently suffering from a bout of severe flu-like symptoms. He is expected to make a full recovery "shortly."

There has been much speculation on the disposition of the popular governor of Demeter these last few days, and this vague announcement has only fueled the fire.

Chief among these rumors is the assumption that the governor has been kidnapped or killed by hostile agents. The identity of the kidnapers varies, ranging from MIIO, to Devlin Stone, to ComStar, to the Capellans. In all cases, the presumption is that de la Sangre, as the veritable poster boy of peaceful assimilation in to the Word of Blake Protectorate, was targeted as the first step towards a Demeter invasion. While authorities have been working hard to convince people that any military action is occurring far from here, the proponents of these conspiracies are bolstered by the fact that the Demeter PM has entered in to a state of maximum readiness. The announcement today that the Militia will be engaging in "routine military exercises" has done little to calm these rumors, especially as the announcement came on the heels of the announcement concerning the governor's health.

Another equally virulent rumor is that de la Sangre has been made indisposed because he is being blackmailed. Stories of the governor's promiscuity are not new, although none have ever been proven in a court of law. As always, the Office of the Governor has brought libel suits against any organization that has printed the accusations in anything but the most circumspect of phrasing, and we here at the *Demeter Daily* certainly regret that the public simply cannot tear itself away from the vicious rumors.

Few can deny that the governor's absence is harmful to Demeter. Already the markets are feeling the effect of the PM's increased readiness and the troubles elsewhere in the Protectorate. Local speculative trading has also jumped on de la Sangre's absence from Vicore Industries, as it is well known that he continues to play a major role in the company's continued success on a daily basis.

### STONE VS. CLANNERS?



*[The grainy, black and white picture shows the entrance to what is obviously a mobile mess hall barrack. A trio of uniformed figures leave the building and huddle around an empty oil barrel that stands in as an oversized ashtray. Audio is surprisingly clear.]*

**[Male Soldier 1]:** "Walls bulged, I say! Never saw the old man fuming like that before. Heard that dressing down three barracks over. That Ward guy never knew what hit him. Shuffled out like the wet dog he is. Stone put him back in the spot..."

**[Female Soldier]:** *[snorts]* "Hardly, Jamie, hardly. What I heard was, that their aides stepped in to calm down Khan Ward. Devlin's life hung on a bare thread there. What was he thinking? He should know Clanners better than that!"

**[Male Soldier 1]:** *[draws on cigarette]* "Bleh... Stone's just playing with them. It's what he does. Saving the Sphere and all that. Gives them Clanners a good whacking and shows them how it's done around here. You'll see. He just uses them up against the Word and then kicks 'em out of the Sphere altogether! That's what he does!"

**[Male Soldier 2]:** *[shaking head]* "I'm not sure, Jamie. Ari might have a point there. The Clans don't like to be pushed around. It's not their style. If Devlin was pushing it with Vlad the whole thing might backfire..."

**[Female Soldier]:** "Yeah, think again. That's why we're here in the first place: The Wolves did raid Imbros III despite their orders! And the closer we come to Terra, the itchier they get."

**[Fourth soldier]:** *[strides into view, bellows]* "Okay you lot! Shut it and get back to work. Sharp, sharp!"

—CCTV feed excerpt, Imbros III, 19 February 3077 (veracity unconfirmed)

As such, we all wish the governor a speedy recovery such that we can focus on the future anew!

### REGULUS ASCENDING

(15 February 3077)

Wallis [RBN] – The Fourth Regular Hussars have unloaded their DropShips on the Regular Free State world of DIASS, bringing the entire Free States back under Regular control and sending a clear message to Atreus. Joining the First and Second Hussars on Vosloorus and Olafsvik respectively, the Fourth Hussars have engaged in a massive public relations campaign to win the hearts and minds of a populace wary of the new arrivals.

In what is becoming an increasingly common sight, Royal Gurkha infantry patrol the streets of DIASS City *sans* armor and armed only with their traditional *kukri* daggers. This demonstration of confidence in the intentions of the local populace has gone a long way to calming tensions that the Hussars' arrival has evoked.

**3077: CLOSING THE CIRCLE**

The Fourth's arrival has also drawn the ire of both Oriente and Atreus, with Captain-General Corinne Marik joining the false Thomas "Marik" in criticizing the Regular actions, saying that such aggressive posturing cannot go unchallenged. To this end, sources within the LCCC have unofficially suggested that Commonwealth forces will soon be deployed to the Regular Free States in order to the oppose the so-called "illegitimate territorial encroachment." Whilst nothing official has been stated so far, there is evidence that multiple commands are being prepared for deployment.

The Hussars' presence has been met with both support and skepticism, with the local populace wary of Regular interference in their daily lives, especially in light of the misinformation spread regarding the extent of former Prince Kirc's Purge. There is also an underlying sentiment that the Hussars' presence will inevitably bring conflict to the Free State worlds, something the

worlds have managed to avoid thus far. Local opposition to the Regular forces has at this stage remained non-violent, with the sit-in outside the First Hussars' Vosloorus encampment increasing to just over a thousand people.

**NIGHTMARISH HOLIDAY**

—Partial message distributed to tabloid news sheets, declassified for court evidence

**From:** Thomas.Miranda@cpol.gov.reg

**To:** CPOL List

**Cc:** RSS Cameron

**Rate:** 6 May 3077

**Subject:** [SEC: CLASSIFIED] CASE #1193D0-A2

First of all, I'd like to thank you all for your discretion regarding the events forthwith. I know for a lot of you, something

**WANTED: WAR CRIMINALS**

The restored planetary government of Towne has issued the following warrants for arrest.

**Maria Acevedo**

[Image: Middle-aged woman kept young-looking through cosmetic surgery]

**Warrant#:** 77.A213-23644

**Wanted For:** collaboration.

Anchorwoman for Towne News Network. Last seen at Prince John Spaceport on 13 May. May be traveling with male companion. Not considered dangerous.

**Features:** Brown hair. Brown eyes. 175cm. 57.6kg.

**Jacob Erbe**

[Image: Balding man with a young face and glasses]

**Warrant#:** 77.E610-82729

**Wanted For:** collaboration, kidnapping, criminal negligence and crimes against humanity.

Former Minister of Education. Administrator of the Fervent Light Reeducation Camp under the Blakist Occupation. Last seen in Gunderland Province. May be seeking shelter with late wife's family. Not considered dangerous.

**Features:** Salt-and-pepper hair, balding. Gray eyes. 185cm. 96.1kg.

**Kurtis Francisco**

[Image: Youngish man with hard look in his eye]

**Warrant#:** 77.F652-22147

**Wanted For:** destruction of property, criminal negligence, sixty-two counts of first degree murder, and operating a construction vehicle without a license.

Word of Blake MechWarrior. Responsible for destruction of

Gherstwood Central Centre shopping complex. Reports that he stayed behind when Blakist forces left Towne possibly confirmed by alleged sighting in Gherstwood on 20 May. ARMED AND DANGEROUS. DO NOT APPROACH.

**Features:** Black hair. Brown eyes. 182cm. 86.6kg.

**"Evelyn Hanratty"**

[Image: Blurry surveillance still showing a young woman with an automatic rifle]

**Warrant#:** 77.H563-59762

**Wanted For:** armed robbery, destruction of property and collaboration.

Sought in connection with the armed robbery of the Mitra Planetary Bank & Trust in downtown Port Howard on 01/25. Known aliases: "Marlena Plentywounds", "Harriet Brill", "Gina Turk". ARMED AND DANGEROUS. DO NOT APPROACH.

**Features:** Blond hair. Blue eyes. 160cm. 47.1kg.

**Geoffrey Yu**

[Image: Man in his mid-30s, with tattoos over his shaved skull]

**Warrant#:** 77.Y000-52648

**Wanted For:** kidnapping, extortion, larceny and collaboration.

Local thug, worked with Word of Blake occupiers to round up dissidents and resistance fighters. ARMED AND DANGEROUS. DO NOT APPROACH.

**Features:** Black hair. Black eyes. 193cm. 106.5kg.

If you have any information on the whereabouts of these individuals, please contact your local authorities.

—Flyer distributed throughout metropolitan Port Howard, June 3077

## 3077: CLOSING

like this is a new and highly disturbing experience, and I am endeavoring to make sure each and every one of you has the support they need at this time. The Chaplain's office will be contacting districts, and counselors will be deployed as required.

As most of you know by now, at 1725 04MAY3077, the bodies of Princess Michelle Cameron-Jones and her unborn son were found deceased at the RSS safe house assigned to her use during her convalescence here. What has become apparent is that an unknown number of assailants circumvented the RSS security cordon in place and made ingress into the victim's private wing. As all staff on locus was vetted by CPOL SPG, the RSS will be conducting a complete review of security and I urge you to cooperate with them fully.

As much as it pains me to say, the chances of us apprehending the POI/s in this case are small at best. That said, I expect each and everyone one of you to use the full resources at your disposal. Overtime and Forensics have been authorized for every district in matters regarding this case.

What I do not want to see is any leak of the condition of the bodies, or the manner in which they were killed. I especially do not want the message written on the wall to be made public. Paranoia surrounding the Blakists is at an all-time high as it is, and there is no compelling evidence to suggest that "Sonja Amora" was in any way actually involved here. If the public hears about that, we'll have pandemonium on our hands...

### HUSSARS CRUSH OPPOSITION

(10 September 3077)

Vosloorus [INN] – The shadowboxing that has typified the Regular occupation of Vosloorus was swept away yesterday in an tide of destruction that has had unexpected results.

The Seventh Free Worlds Legionnaires, newly arrived on-world to replace the departed Second Marik Militia, was simply unprepared for the ferocity shown by the First Regular Hussars when they slammed into the Legionnaire defenses. This ferocity was exemplified by Force Commander William Trulo, commander of the reformed Dead Reckoning company, whose *Patriot* was credited with seven kills in the assault. The Reckoning was instrumental in decapitating the Legionnaires' command structure, and can be credited with bringing a swift end to hostilities.

Since Prince Titus Cameron-Jones' announcement regarding the massive expansion of the Regular Hussars brigade, Regular forces have become increasingly more belligerent on the worlds of the Regular Free State that they have occupied since the beginning of the year. With previous Marik Commonwealth deployments having seen little combat (if any), the Legionnaires were expecting a tense situation but were clearly unprepared for the reception they received.

But most telling is the amount of defections from the Legionnaire forces in the wake of the battle. Whilst some Legionnaire lances have pledged their loyalty to their

### PRINCE KIRC CAMERON-JONES: RETROSPECTIVE

(18 September 3077)

Regulus [RNN] — After a month of suffering since his fall in August, state officials have confirmed that Kirc Cameron-Jones has finally passed away peacefully but before his time. Prince Titus Cameron-Jones has declared the untimely death of his seventy-three year old father as "yet another heinous Blakist act" indicating that Kirc Cameron-Jones' illness and death were due to some form of poison and not natural causes as originally indicated.

"It is acts such as these that demonstrate the true evil of the Blakists, striking down an old man who no longer poses any threat, in an insidious way for no other reason than that he successfully opposed them in the past."

Kirc Cameron-Jones took on the old title of Prince not long after assuming hegemony over the Cameron-Jones line in 3057. Long an ardent crusader in the pursuit of greater Regular prominence and independence from Federal repression, Prince Cameron-Jones attempted to salvage the fragmenting League by assuming the title of Captain-General in 3069 as a result of the incredible crisis facing the Free Worlds League as a whole. Unfortunately, Blakists manipulation and force prevented his efforts at stabilization.

Prince Kirc proved himself a persistent and stalwart opponent of the Blakists, going as far as striking directly at their main strongholds on Gibson in 3073, despite several military setbacks. The failure at Gibson and other prior military defeats were traced back to Blakist spies within the Regular ranks, forcing the Prince to make several difficult decisions during his reign to vouch-safe the Regular people as a whole.

Regulars continued to benefit from his judgment when he abdicated in favor of Prince Titus, ensuring a peaceful and orderly transition of power during a time of war. Even then he devoted himself to the cause, actively participating in the Principality's defenses. His earnest and frank discussions with his son have become an example of constructive and honest discourse.

While frequently betrayed by the weakness of his neighbors, all can agree that Prince Kirc Cameron-Jones was one of the Principality's most capable and successful Princes, and we have all lost a major aspect of the Regular nation this day.

vanquishers, more still have expressed a desire to be repatriated to states other than the Marik Commonwealth. At least three lances have expressed an interest to go to Andurien, and two full companies made known their desire to be repatriated to Oriente. Thus far, Colonel Lord Ihsan Hunter has acceded to these requests, citing the need to maintain good relations with non-Commonwealth states.

As the Regular ankh flies over the soil of Vosloorus unchallenged, the pride on the faces of the soldiers of the Hussars, and the relief on the faces of the people of this world, cannot be missed.



## 3077: CLOSING

**FEDERATION BUILD-UP**

(21 September 3077)

Alphard [ISAP] – Unsettling news from the Caesar's palace. Inside sources claim to have spoken with couriers returning from the Circinus Front, and the messages they carried isn't good. Apparently the MHAF aborted its latest offensive into Federation space after less than a week of actual fighting. With no mission objectives achieved, the troops are digging in close to the border and waiting for new orders. MHAF high command is in turmoil and no official statements have been released as to why the long-planned territorial expansion had been stopped so abruptly.

Leaked excerpts from internal reports only give vague hints. The worst-case (and most likely) scenario claims that the Marian offensive never really started. According to command logs, most of the troops slated to deploy were instead ordered into defensive positions only three days after the operation launched. This fits with rumors circulating that the initial probing attacks on Thadora's Land and Zorn's Keep were swiftly rebuffed within two days—even hours—of landing.

Reliable numbers are impossible to place at this time, but it is safe to assume that the Legions met a three-to-one superiority in size as well as equipment standard. Where the Circinian forces got the resources and technology can only be speculated at this time, but it does not bode well for the stability in this region of space. Either the settled pirates stumbled upon a material mother lode—or the Blakists are now supporting the Circinus Federation on a grander scale than previously thought possible.

Nowadays the latter scenario is much more likely, but no less frightening. Of course, shady deals with savages are the specialty of more than one faction. *Is this the Word's doing, even as the forces of the Inner Sphere hammer them from all sides? If so: What do they hope to achieve here?*

**STONE'S EVIL STAIN**

(6 November 3077)

Terra [VOT] – IN THE NAME OF JUSTICE: KILL THEM ALL!

Thousands slaughtered on Bharat! Coalition forces act out Stone's Death Orders as artillery wipes out refugee camp.

Now is the time of our greatest need, the final watershed where the wheat is separated from the chaff. Good steps into the light. Evil tumbles into darkness.

So far, Stone has managed to convince millions that his "Coalition" is a blossom-white savior and the Word of Blake devil incarnate. But as with any other conqueror "to slay evil, one must become evil" is the ultimate ingredient in Stone's cookbook. Believing the Word of Blake to be evil, Stone has wasted no time "becoming evil" himself.

Be warned, good citizens of Terra: this is just the tip of the iceberg, the first flickering flame of a firestorm that will engulf any who threaten Stone's ambition to rule all.

## OUTREACH FREED

(21 November 3077)

Outreach [SNS] — After almost a decade, Outreach is once again free. While several worlds joined the Blakists prior to the fall of Outreach, few can argue that it was one of the first worlds to fall in the war we now call the Jihad.

And its people certainly have done more than their fair share of suffering. Between a massive civil war, and even more devastating bombardments of every kind possible, Outreach's population has plummeted, and the planetary infrastructure and economy is a shambles. Once one of the most advanced worlds within human space, Outreach has difficulty producing technologies that were commonplace a thousand years ago.

It is clear now that the Blakist attempts to pull Outreach into its Protectorate fold have persistently failed. It is too early to have a full picture, but the evidence to date shows a world where the Blakists never managed to build a functioning planetary government. Instead they sought to pacify the world by any brutal means necessary, destroying all vestiges of the Dragoons and their influence on the world.

One particularly harrowing example of the atrocities can be found just north of New Wyatt. There, prisoners in the local "reeducation camp" spent their days, dawn to dusk, digging a trench that circled out from the camp. Behind them, the bodies of the dead would be thrown. No one would bury them. The sheer amount of remains found at the site is truly and utterly mind numbing.

Given such atrocities, the spirit of the common men and women of Outreach is commendable. Whenever questioned by Blakists authorities, men would identify themselves as "Jaime Wolf," while women call themselves "Natasha Kerensky." It is perhaps in that spirit that the leader of the Four Horsemen, a band of rebels still at large, calls herself "Tara Lucas," even though Lucas was reported killed in '71. The Horsemen, credited with inflicting severe casualties amongst Wannamaker's Widowmakers, still carry the name as a badge.

Perhaps these are signs that although Outreach's cities and factories may have been broken, the peoples' spirit remains intact.

The camp on Bharat was a haven for those who have seen the Blessed Blake's light. They were critics to Stone's reign, driven from their homeworlds for no other reason during his campaign of "liberation." Outspoken, yes, but ultimately innocent and peaceful. Due to "imprecise reconnaissance," Stone and his allies casually murdered them all, playing it off as a "regrettable friendly-fire incident." This blatant lie made up by Stone's censorship offices does not hide the bodies now buried on Bharat in shallow mass graves.

Who dies next for this man's insane quest? The Coalition commander on-planet who wanted to avert bloodshed? The nurses and doctors visiting refugee camps just before the

## 3077: CLOSING

first shells hit? The boy who does not salute Stone's hat on a flagpole? Bharat is the proof that Devlin Stone is no better than the corrupted House rulers who back him. Everyone and everything opposing his way will be crushed—be it friend or foe.

People of the Sphere: It is still in your power to stop this tyrant-to-be. To end Stone's grab for power, prevent uncounted atrocities now. Save the future of your children.

SUPPORT THE WORD OF BLAKE!

**HALL SURRENDERS WITHOUT A SHOT**

(21 November 3077)

Hall [INN] — Freeing the people from the tyrannical grip of the Word of Blake has been a tough task, fraught with toil and death. But not on Hall.

There, all it took was one woman.

Bethany Barratt is not only a hero to everyone on Hall, but she is also one for all of the soldiers in Stone's allied Coalition. After so much destruction and death, for once to have it easy seems a complete miracle. When General Belle Lee brought Stone's Lament and Stone's Stalwart to Hall, they were prepared for another drawn-out fight against Blakist partisans. Instead, Private Barratt took the initiative to contact the Blakist commander and found him amenable to a cease-fire and discussion. Upon meeting the governor, Barratt negotiated the surrender and disarmament of Hall's militia that would avoid the certain slaughter a Coalition invasion would create. As the task force leaders stood by in elated bewilderment, Hall's Blakist governor, Franco Reynolds, proclaimed the world's surrender via planet-wide broadcast before submitting himself and his staff to the Coalition for arrest. Even more amazing, the war-weary people of Hall, familiar with conflict since the formation of the Chaos March, welcomed this peaceful transition while the Protectorate Militia forces laid down their arms.

Though bloodless, Hall's capitulation did not come completely without casualties. Even as Coalition forces escorted the disarmed Protectorate troops into ad hoc POW camps on-planet, the Militia's commander, Precentor Andrew McFadden, reportedly took his own life, and Precentor Hedwig Verona, chief of the Word of Blake's Spiritual Enlightenment agency on Hall, was killed while attempting to escape custody.

Both General Lee and Devlin Stone praised Private Barratt's initiative as a warrior-diplomat.

"Bethany has done a great job on Hall," said Stone. "We need more like her. I think she may have the chance to help our endeavors at a higher level."

"I'm glad Hall went so easy," Barratt remarked during the victory celebrations. "Even knowing how these people suffered here since the start of the war, it seems almost impossible that those events could line up."

## THORNY THORIN

(31 December 3078)

Thorin [RNS] — Question: Under *zellbrigen*, how do one engage Shadow Divisions?

Answer: With orbital bombardment.

This tactic was put to excellent use on Thorin. Please visit Grummon, Lent, and Fell's Fort next time you're in the neighborhood. Be warned: there might be a bit of a jump in local sales tax, as I understand proceeds from local income taxes have dropped dramatically.

Guys, I know we all love it when the Bears kick ass, but surely, this is getting a little out of hand? It's like they've got two speeds: dawdle, and a *Leviathan* full of overkill. I don't know who crapped in their breakfast flakes, but they need to chill out. This time, the Bears only *thought* there *might* be a Shadow Division or two on Thorin, so they slagged a couple of cities from orbit, and *then* sent in the scouts? Maybe that should've happened the other way around.

Now don't get me wrong. I'm a pretty big fan of decisive action. There's been so precious little of it before that guy Stone showed up, after all. But it'd be awfully nice if our benefactors could maybe put a few more CPU cycles in the planning part of the exercise.

Want another example? Remember when the Second Freemen and First Kavalleri decided enough was enough? Bear reaction: stomp those jokers *and* pull every freaking KungsArmé Cluster back to the Dominion. Now, the first part of that I can actually endorse. Calm down now, think with your head, not your gut: if they wanted things to be different, they should've gone through channels. With the Clans, said channels don't even have much red tape. I think they were *right*, but they sure picked the dumbest way imaginable for trying to fix things. If you're still fuming, you're thinking like a Bear: all piss and vinegar.

Anger gets a lot of things done, and cuts through a lot of bullshit. But in a might-makes-right world, I sure would like more of the intelligent, thoughtful might, not the face-eating psycho kind.

**NOWHERE RAIDED**

(7 July 3077)

Nowhere [ISAP] — Twelve dead, scores wounded, and millions of C-bills in damage and theft as pirates hit Nowhere. The Farstar Pirates have struck again with their fourth raid on Nowhere since March and the seventh in the Qandahar Prefecture.

The Nowhere Militia is hard-pressed to even drive off the bandits, let alone deter them, after incurring yet more losses. After landing outside the Barryland spaceport, a company of BattleMechs led a dozen cargo vehicles past the platoon guarding the facility. They then proceeded to loot the warehouses of both incoming and outgoing merchandise.



**BLACK DRAGONS CARRY OUT THREATS**

>>OpenSystemKORRA.KOR.MASS//DRAKESTRUTH<<

There are no words. NO WORDS.

I'm literally shaking right now, I'm so angry and ashamed.

To see what we've allowed, what we've become!

Don't understand? You will. Watch.

*[A grainy vidclip begins, opening from a high vantage point down on what appears to be a small town of orderly barracks and buildings, encompassed by tall fencing and cornered by watchtowers. Several APCs are parked beyond the fences, their gun turrets aimed at the facility. A caption at the bottom of the screen reads "KORRAMABAD AZAMI FACILITY #25". Three specks can be seen in the sky, growing larger. After a few seconds, the specks turn into large, heavy bombers that drop several items from their bellies. Two seconds later, the entire town explodes, awash in flame. People can be seen running about, some on fire. Those who escape the flames are cut down at the fence line by the APCs. There is no sound.]*

Those sons of bitches did it. The damned ISF may have gacked the original leadership, but apparently they didn't count on Premier Otogawa stepping up to the Devil's position.

That scene? Repeated at half of the "holding centers" on Korramabad, solely in retaliation for the ISF's stupidity. Killed nearly half a million of them! HALF A MILLION LIVES! And that was two weeks ago... New Year's Eve! The deadline for the Black Dragon's demands to "remove all Arkabs" has passed. What other horrors have occurred? Where is the Dragon for these innocents?

WHERE?

—Netpost on the Drake/New Samarkand free press server, 12 January 3078

The Militia massed outside of Barryland and pushed forward with a dozen combat vehicles and a lance of BattleMechs. They arrived at the spaceport and engaged the pirates, but the raiders were able to hold the militia off long enough for their transports to finish loading. They then executed a fighting withdrawal, escaping with all but a destroyed *Panther*. The Militia lost two BattleMechs and four vehicles. Half of the remaining combat units took major damage. Though planetary governor Ahano Michi recently took steps to augment the local defenses with the purchase of four new *Quasit* MilitiaMechs, it seems unlikely that—should these forces even arrive before the next raid—they will provide a significant deterrent to the rogues plaguing the Dragon's outlying planets.

Nowhere to be seen on Nowhere is the DCMS. It is as if the Qandahar Prefecture has been stripped of its regular military forces in the drive to Terra. Yet while removing the Blakist threat is a noble goal, should it come at the expense of protecting the citizenry from all threats? Fifty years ago, Farstar would find a regiment of the Combine's best dropping in on them, to exact

**CLOSING THE CIRCLE**

revenge and remind the raiders not to trifle with forces beyond their measure. But now?

Now is a different era.

**FREE?**

The Chancellor has at long last deemed Zurich worthy of liberation. Capellan forces have landed and have seized most of the important facilities and population centers here on Zurich. Surely the dedication and sacrifice of the CCAF should never be questioned. Theirs has been a war of attrition and hardship. They have clawed and scratched and bled for every inch of ground since their arrival. They have pushed the Blakists from our cities and our homes.

We are told that Zurich is once again free, that we can walk our streets safely. We are once more under the protection of the unwavering Capellan banner. Certainly, the destructive and desperate battles of the past two months seem to be a thing of the past. Truly the people of Zurich have much to be thankful for.

But to say we are *liberated* is to deny a fundamental truth. The Word of Blake is battered, perhaps even broken—but they are *not* gone yet. They remain among us. They have taken their insidious war underground and now wage a campaign of terror against our citizens.

Just last week, the People's Justice Center was taken by Blakist sympathizers. They butchered hundreds before security forces could root them out and reclaim the building. The images of the attack are now seared into the collective mind. They will impact us in ways mere footage of battle never can.

Now, we hear reports of BattleMechs striking the city of Kuanchan. We see video images of Blakist forces making a bold strike against one of the CCAF's garrisons. How can we believe in "liberation" or "freedom" if the military cannot even protect *itself* from such attacks?

The Word of Blake isn't gone, my people, they are merely pausing to gather their strength.

—Zurich Underground, *Is This Freedom?*, Publisher Unknown, December 3077

**HEGEMONY ARRIVES**

(6 December 3077)

San Nicolas [PFP] – Five thousand dead, ten thousand wounded or contaminated, and ten times more homeless. Two cities destroyed, and countless acres poisoned for millennia. Kendall is free again—but at an immense cost. Not only does the planet lie in ruins, but with it the granary of a whole sector ceases to exist. It makes one wonder about the future fate of San Nicolas.

It hasn't been a month since the Marian Hegemony invaded Kendall, almost casually assaulting Lahti and Landfall as well. Apparently, no one in the FWLM thought it necessary to mount even a hint of defense on any of those three worlds.

### 3077: CLOSING THE CIRCLE



Now faced with widespread devastation—wrought by the planet's own defenders—tensions run higher every day. Public opinion is polarized: Was the use of nuclear weapons to drive off the pirate invaders worth it? Or would living under Marian occupation have been the better option, as the League continues to collapse? Nobody knows how the would-be conquerors will react once they realize that their II Legio isn't coming back. Will there be further reprisals? Or will their young and brash Caesar finally get the message?

With Kendall as food supplier dead, nearby San Nicolas could perish from starvation. A planet wedged tightly between a rock and a very hard place. Will they take comfort as they die that the Hegemony's advance was stopped for a time? Or will Kendall's "victory" be cursed across the stars as the Hegemony advances elsewhere?

#### THE MYSTERIOUS CASE OF NORTHWIND

(21 January 3078)

Galatea [MERCNET] — We can now add Northwind to the list of worlds no longer under the Word of Blake's boot. But to many, they've never been to begin with.

Northwind's situation has long since baffled observers. Disappearing off the grid at almost the same time as Outreach, many believed that a similar fate had come to the Northwind Highlanders that the Wolf's Dragoons suffered. This perception was amplified by the inability to get a single ship to Northwind

without a Blakist interception. Its HPG down, Northwind became a dark, mysterious hole in the universe whose mystery only deepened in October of '72, when a group of DropShips claiming to be Highlanders' vessels launched an invasion on Galatea.

Those Highlanders obviously weren't the real deal, but it took a little while for that fact to shake out and become common knowledge. Even now, a favored theory still maintains that the Highlanders have been on the WoB payroll since the Jihad began. I sure as hell wouldn't want them guarding my rear area, if you know what I mean.

Crackpot theories aside, the circumstances sure are bizarre. How *does* one ensure a group of supposedly ornery modern-day Celts keep their killed arses on their own rock without nuking them senseless first? And yet, there they are: a quite intact Highlanders force, cleaning up Dieron after the Ghost Bears' party!

Another theory is like something my daddy always said: "Never attribute to malice what can be explained with sheer stupidity." Let's say the Highlanders were fed a story so convincing that they decided to play nice for a decade or so. This theory is truly laughable, because I honestly can't think of a story weird enough that it would cover it. Hell, a DropShip could've made it to Quentin the hard way by now.

Honestly, I don't know, but I can tell you that once we hear the truth, it'll be funnier and weirder than any of us can imagine. Reality's always stranger and wilder than fiction.

### KIRI-J(F) SYSTEM SECURITY SCANNER (12.3.89 BUILD 505)

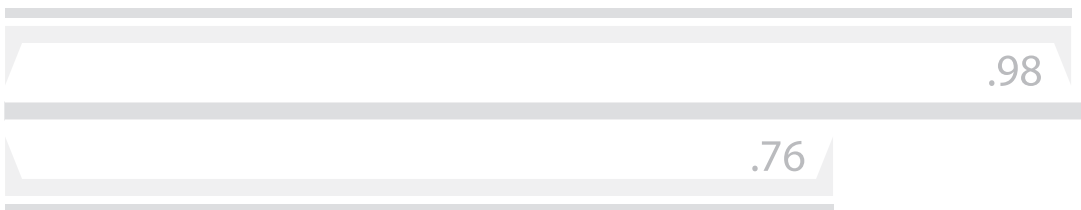

SECURITY LEVEL AMBER



## CHAOS ETERNAL: WATERSHED

## WATERSHED

*We entered the system with no one realizing who we were going to attack. As far as both sides were concerned, we were the big damn heroes riding in to save the day from a humiliating disaster.*

*The problem was that I don't think many of us realized which side we were on either. It was not until the orders came over the comms. on who exactly to target and open up on, with many of us only a dozen or so meters away from them. We took them by complete surprise.*

—Journal entry, J76-340

## SITUATION

Capolla, Word of Blake Protectorate  
3 December 3076

Just when it looked like you were about to die from boredom, Mr. Askai appeared from nowhere with another contract, a mission on Capolla involving Deliah's Gauntlet and the Protectorate. Seems the Gauntlet abandoned their contract with the Word over a disagreement with standing orders; interestingly, Askai has presented you with a choice: support the rogues and get them out of there, or deal out some punishment to fellow mercenaries who continue to soil the profession's good name. Mr. Askai gave you all the time in the world to figure out your decision, right up until you were staring down the PPC barrels of both sides...

## CHAOS ETERNAL: WATERSHED

## GAME SETUP

Set up a mix of Flatlands Terrain mapsheets (see *TW*, p. 263), treating any paved hexes as clear.

## Attacker

The Attacker's are the remnants of the Deliah's Gauntlet mercenary company and are 50 percent of the player's deployed force. The mercenary unit is of regular skill level and enters on the map edge of their choosing, designated their Home Edge.

## Defender

The Defenders are forces from the Capolla Protectorate Militia. The Militia is of regular skill level and is 100 percent of the player's deployed force. The Militia enters on their home edge opposite the Attacker.

## Player's Force

Players may deploy up to 50 percent of their total available force. The Player's force may enter any edge not chosen by the Attacker or Defender.

## WARCHEST

**Track Cost:** 300 WP

## Optional Bonuses:

**+600 Dissention in the Ranks:** When the player's force decides which side to support, not everyone agrees. For each deployed unit of the player's force, roll 2d6. A result of 8+ causes that unit to switch sides; control of the unit now passes to either the Attacker or Defender. Units that successfully defect suffer a +1 penalty to all To-Hit rolls when targeting a former comrade.

Units that defect are considered destroyed for the purposes of achieving Objective #2.

**+200 Light Fog:** Use the Light Fog rules for this track (see p.57, *TO*).

## OBJECTIVES

- 1. None Shall Pass.** Destroy/Cripple over half of the declared enemy. **(Reward: +400 WP)**
- 2. Holding On.** A third or more of the Player's force survive without being destroyed or crippled. **(Reward: +400 WP)**

## SPECIAL RULES

*The following rules are in effect for this track:*

## Declaration of Intent

The player's force must decide which side they will support by the end of Turn 3. Once the decision is made, it cannot be undone. The side chosen becomes friendly to the player's force during the Initiative phase of the next turn.

If the "Dissention in the Ranks" option is in play, all rolls are made immediately after the decision is made. Rolls may be made before play begins but after forces are determined, if the decision occurs before the start of the game.

Until the decision is made, the player's force may not attack any other units on the battlefield. However, either side may fire upon the players' units until the decision is made.

## AFTERMATH

The fight Deliah's Gauntlet put up while escaping was brutal all around, and only a handful of them made it off world. As for you and your group, well...seems Mr. Askai had one more

## CHAOS ETERNAL: WATERSHED



trick up his sleeve before he disappeared again. News of your “betrayal” hit MercNet faster’n a Flea on fire. A simple message was all that bastard Askai left behind: “You spent the last eight years making your bed – now you must lie in it.”

Seems you’ve finally made your choice in this war. As the ancient saying goes, “In for a penny, in for a pound.”

### ADDITIONAL HOOKS

Feeling humiliated and cheated, the force you opposed has decided to put out a sizable reward for your unit. Bounty hunters and other mercenaries will make various attempts throughout the campaign to capture or kill the player’s unit.

### NEXT TRACKS

If the player’s unit sided with the Protectorate Militia, proceed to *Blood and Fury*. If they sided with Deliah’s Gauntlet, proceed to *Ghost Tiger*.

## CHAOS ETERNAL: GHOST TIGER



### GHOST TIGER

*“...In addition to the movement of nearly ninety percent of the Protectorate Militia to Mizar, the lack of supply runs over the last two months has led us to believe that the understrength garrison cannot hold out for more than a few weeks - even if it attempts to wage a protracted insurgency without extensive civilian support...”*

—Excerpt from Coalition intelligence report YORII.INT.AYS, dated 10 January 3077

### SITUATION

*Yorii, Word of Blake Protectorate  
20 January 3077*

Askai apparently set you up with a new contract broker—some suit calling himself “Burne.” Solid bet the man was a new liaison to Stone’s Coalition, since he referenced a few jobs back where you crossed paths with them. This assignment was a plum; assist the Coalition in the conquest of Yorii using overwhelming numbers, then remain behind until provisional garrison forces and Stone’s support services arrived.

Intel reported that much of the original Protectorate militia had left the planet, leaving only a bare-bones garrison. Could it get any easier?

## CHAOS ETERNAL: GHOST TIGER



### GAME SETUP

Set up a mix of Flatlands Terrain mapsheets (see p. 263, *TW*)

### Attacker

The attacker consists of up to 25 percent of the player’s total available force. The Attacker enters from any one map edge.

### Defender

The Defenders are Protectorate Militia consisting of only BattleMechs and battle armor. The Defender is of veteran skill level and equals 125 percent of the Attacker’s deployed force. The Defender enters from their home edge, which is opposite of the Attacker’s starting edge.

### WARCHEST

**Track Cost:** 500 WP

### Optional Bonuses:

**+200 No Honor:** The Defender disregards all Special Rules for this track.

**+200 Worthy Opponents:** The Defenders have Elite skills.

### OBJECTIVES

**1. Take ‘em down.** Destroy or cripple more than half of the Defender’s forces by the end of Turn 12 (**Reward: +400 WP**)

**2. Non-Lethal means.** Cripple or force the withdrawal of at least two-thirds of the Defender’s force. (**Reward: +400 WP**)

**CHAOS ETERNAL: GHOST TIGER****SPECIAL RULES**

The following rules are in effect for this track:

**Honor Bound**

The defending forces are considered to be using level 1 Clan honor rules (see p. 273, *TW*).

**Forced Withdrawal**

Both sides are operating under the Forced Withdrawal rules (see p. 258, *TW*).

**AFTERMATH**

It seemed almost too easy as Coalition forces systematically destroyed the defending forces. It wasn't until Devlin Stone's arrival that they realized the defenders were using *zellbrigen* and that something was different. Once communication between the

two sides was established, the would-be liberators discovered that the "Protectorate Militia" was in fact a group of Smoke Jaguar POWs who had recently driven off their Word of Blake guards and had been left to fend to themselves.

**ADDITIONAL HOOKS**

The Smoke Jaguars are extremely wary of Stone's offer to join the Coalition, wary of losing their dying culture altogether. Merging such a strict Clan culture into the "Spheroid way" is a tall task that can make or break aspiring political minds—and may land a few enterprising personages some heavy favors or deadly enemies.

**NEXT TRACK**

*Charred Victory.*

**CHAOS ETERNAL: BLOOD AND FURY****BLOOD AND FURY**

*"So what if they pulled that stunt on Capolla, fooling Stone and his lackeys. Like hell we were going to listen to that small time command. The Word paid my bills so I'm going to take orders only from them. But as we were landing in the middle of that city, those silos simply looked like bonus pay to us..."*

—Excerpt from the interrogation of "Pirate #429", Marcus World Security, 12 August 3077

**SITUATION**

*Marcus, Coalition-occupied Protectorate  
8 August 3077*

After proving your worth and skill in wiping out the renegade mercs on Capolla, the Word offers you the leadership of a force of small mercenary and pirate bands to retake Marcus from Coalition forces.

Hey, it isn't like anyone else is going to hire you now at this point, right?

**CHAOS ETERNAL: BLOOD AND FURY****GAME SETUP**

Set up a mix of Heavy Urban Terrain mapsheets (see p. 263, *TW*). Halve the starting CF of all buildings present.

**Attacker**

The Attacker consists of up to 25 percent of the player's total available force. The Attacker is augmented with four separate groups of equal size, mercenaries and pirates of Green skill level. These groups must contain at least two different types of units. None of the groups may contain more BattleMechs than the player's deployed force.

The Attacker enters from any one map edge.

**Defender**

The Defenders are from the Twentieth Marik Militia. The Militia is of Regular skill level and is 75 percent of the attacking forces.

The Defenders set up anywhere on the battlefield after the Attacker has declared their entry edge.

**WARCHEST**

**Track Cost:** 400 WP

**Optional Bonuses:**

**+100 Could have sworn there were more:** Up to a third of the Defenders may be deployed at the start of the game using Hidden Units rules (see p. 259, *TW*).

## CHAOS ETERNAL: BLOOD AND FURY



**+50 You want us to do what?:** Half of the Attacker's force is hot-dropped (see pp. 22-23, *SO*) onto the battlefield at the start of turn 3.

**OBJECTIVES**

- 1. Pummel.** Destroy/cripple at least half of the Defender, including turned units. **(Reward: +400 WP)**
- 2. Good PR.** Destroy/cripple all unruly units before the end of turn 8. If there are no unruly units, add this reward upon the successful completion of Objective 1. **(Reward: +200 WP)**

**SPECIAL RULES**

The following rules are in effect for this track:

**Waves of Grain**

When a building hex is destroyed, roll 2d6. On a result of 8+, the building is a silo holding stockpiles of grain that spill out to every non-water, non-building hex of equal or lower height adjacent to the destroyed building hex, converting it into a sand hex for the rest of the track. Conventional ground vehicles and non-battle armor infantry caught in the hex during the transformation are considered stuck for a turn. Infantry also receive 1d6 damage. BattleMechs caught in the spill must make a Piloting skill roll to prevent falling but are otherwise unaffected.

**Unruly Mob**

Some of the Attacker's smaller groups feel snubbed and are disobeying orders. At the start of Turn 4, roll 2d6 for each group.

Add +2 to the result if the group was hot-dropped onto the battlefield.

On a result of 8-9, the group decides to go on a destruction spree, targeting the closest non-destroyed building hex and firing with all its weapons possible without overheating until the end of Turn 8. At the start of Turn 9, the group operates normally for the rest of the track.

On a result of 10+, the unit decides to switch sides and is controlled by the Defender for the rest of the track.

**AFTERMATH**

Despite the confusion and power struggles within your own task force, the sheer ferocity and chaotic nature of your attack confused and scattered the Marik Militia. Even the betrayal of a pirate band to pillage a nearby town could not halt your advance, though it did damage the Word's reputation among the citizenry.

**ADDITIONAL HOOKS**

Some of the Twentieth, unable to evacuate, may have gone to ground to harass the already shaky alliance of mercs and pirate groups. Also, depending how brutal the fighting may have been at the last processing center, the normally apathetic civilians may be starting an insurrection to drive off all the military forces, both Coalition and Blakist.

**NEXT TRACK**

*Bridge to Oblivion.*

## CHAOS ETERNAL: CHARRED VICTORY

**CHARRED VICTORY**

*Now I've seen some nasty scenes in my time, but nothing like this. The bodies--men, women, and children--were perfectly preserved. No burns, no blood. Just expressions of pain as they lay everywhere. The Blakists sure knew their trade.*

*So when we finally tracked down that group, we didn't hold back on those bastards. When they eventually surrendered and powered down, we neatly got them all together, got names, information, ident codes and got them lined up for transport to the makeshift prison camp.*

*None of them left the battlefield that day. And our Liaison never said a word to Stone or Lee about it either...*

—Journal entry J77-291

**SITUATION**

Chara, Word of Blake Protectorate  
4 October 3077

Chara was a planet of contradictions. Calm and serene one moment, then a swirling mass of lightning, thunder, and extremes. The Protectorate Militia forced General Lee to a strategy of hit and run attacks to whittle down the defenders, who were using the populace to keep tabs on the Coalition's movement. As each side wore the other down, your unit was assigned to seize a coastal area to prevent the Militia from smuggling troops to Lee's flank. Didn't seem important. More like a "put the mercs in the corner" move. The Protectorate, however, proved you wrong—and Lee right.



## CHAOS ETERNAL: CHARRED VICTORY

## GAME SETUP

Set up a mix of Wetlands and Coastal Terrain mapsheets (see p. 263, *TW*). The Attacker chooses their entry edge first.

## Attacker

The Attacker consists of up to 50 percent of the player's total available force.

## Defender

The Defenders are forces from the Chara Protectorate Militia. The Militia is of Regular skill level and equals 125 percent of the Attacker's forces.

## WARCHEST

**Track Cost:** 500 WP

## OPTIONAL BONUSES:

**+200 They saw us coming:** Defender places 1d6-2 minefields for each mapsheet at the start of the game. The Defender determines the type of each minefield.

**+200 Who trained these guys?:** Increase the Defender's skill level to Veteran.

## OBJECTIVES

**1. Drop 'em.** Destroy / cripple at least half of the Defender's force. (**Reward:** +500 WP)

**2. We don't need your crutch.** Achieve Objective 1 without using orbital support attacks (**Reward:** +600 WP)

## SPECIAL RULES

The following rules are in effect for this track:

## Hand of God

The attackers may use Orbit-to-Surface Fire (see pp. 103-104, *SO*) using the warship *CSV Bordeaux* (*Dante*-class).

## Finicky Weather

Chara is known for its unpredictable weather that can change from minute to minute. At the start of turn 1 and every 7 turns thereafter, roll 1d6. On a result of 5 or 6, the weather fluctuates. Roll 2d6. A result of 2-7 indicates clear weather. With a result of 8-10, apply Lightning Storm rules (see p. 59, *TO*). On a result of 11-12, apply Torrential Downpour rules (see p. 59, *TO*).

## AFTERMATH

Chara's screwy weather was the deciding factor in many of the skirmishes that broke out across the Coalition's front, often in the favor of the Protectorate. It was not until Belle Lee authorized the use of the Coalition's WarShips for ground support did the tide turn against the Protectorate. The Blakists responded to the orbital rain with liberal use of NBC warheads. Casualties were heavy on both sides. General Lee disbanded several commands, folding them into a new unit, Stone's Revenants.

## ADDITIONAL HOOKS

The use of orbital support and NBC weapons left a large humanitarian crisis on Chara, with the infrastructure in serious trouble. With mercs getting a bum rap lately, doing some humanitarian work here could boost morale and image.

## NEXT TRACK

*Trick or Trap*

## CHAOS ETERNAL: BRIDGE TO OBLIVION

## BRIDGE TO OBLIVION

*Pressure from the invaders has continued to build along the coastline and deep into the Myanmar Highlands. As such, it is necessary to sever all possible links across the Scarlet Sea, in order to reduce flanking risk and contain the front to a size conducive to a mid-range biochemical response.*

*"Cut the bridge and contain, or we lose our last bastion of defense."*

—ROM Order 300-2, 24 October 3078

## SITUATION

*Chara, Coalition Occupied Protectorate  
26 October 3077*

The fight for Chara did not go well for the Protectorate Militia after the Coalition brought in orbital support. The Word retreated with the bulk of its forces; what remained quickly disappeared into Chara's wastelands to cause the newly arrive garrison force some pain and grief.

A major earthquake near the port city of Charon provided opportunity to do just that.

## CHAOS ETERNAL: BRIDGE TO OBLIVION



### GAME SETUP

Set up a mix of Wetlands and Coastal Terrain mapsheets (see p. 263, *TW*). At least one stretch of road must connect from one map edge to the opposite edge.

Select one stretch of road that connects two opposite map edges and designate this as the main bridge through the area. This bridge is considered to be at a minimum height of Level 3, adjusted for underlying terrain. For the purposes of this track, the bridge is considered indestructible.

Roads that branch from the main bridge are considered to be at standard height; the intersection points are considered to be road connections located underneath the bridge.

### Attacker

The Attacker consists of up to 50 percent of the player's total available force.

The Attacker enters from one of the edges connected by the bridge road.

### Defender

The Defender consists of forces from the newly arrived Chaffee Militia. The Militia is of Regular skill level and equals 100 percent of the Attacker's forces. In addition, the Defender adds twelve Bailey Armored Cars (see p. 16, *TRO:VA*) that enter from the Attacker's home edge at the start of either Turn 2, 3, or 4. (If the armored cars are unavailable, use standard Flatbed Trucks (see pp. 8-9, *TRO:3060*).

The Defenders set up on the battlefield and deploys within 5 hexes of the edge opposite the Attacker's entry point. The armored cars enter the map from the Defender's home edge at the beginning of Turn 5.

### WARCHEST

**Track Cost:** 500 WP

### OPTIONAL BONUSES:

**+200 Drive On:** The road surface was recently repaved. Treat all road hexes as if they were affected by Ice (see p. 50, *TO*).

**+200 Rough Month:** The Attacker begins with an additional 3d6 damage per unit. Roll critical hits normally, re rolling any

critical hit that may cripple or destroy the unit. Infantry units only receive 1d6 damage per unit.

### OBJECTIVES

**1.) Stealing the thunder.** Prevent at least eight transports from exiting through the Attacker's home edge. **(Reward: 400)**

**2.) Thin the herd.** Destroy or cripple half or more of the Defender's force (not including the transports). **(Reward: 600)**

### SPECIAL RULES

The following rules are in effect for this track:

#### Finicky Weather

*Chara is known for its unpredictable weather that can change from minute to minute. At the start of turn 1 and every 7 turns thereafter, roll 1d6. On a result of 5 or 6, the weather fluctuates. Roll 2d6. A result of 2-7 indicates clear weather. With a result of 8-10, apply Lightning Storm rules (see p. 59, *TO*). On a result of 11-12, apply Torrential Downpour rules (see p. 59, *TO*).*

### AFTERMATH

ROM decided to use your attack of the convoy as a cover to sow some more chaos. During the fracas, ROM troopers planted several charges across the bridge span, barely finishing placing their charges as the remains of the convoy reached the shoreline. The resulting explosion wiped out what was left of the relief convoy.

The Word's remaining insurgents then swooped in with several Planetlifters and Karnovs loaded down with their own relief supplies, endearing the Word to the citizens of Charon and creating a safe haven for insurgents to continue the fight against Stone and his Coalition invaders.

### ADDITIONAL HOOKS

Leaving Chara will be an interesting proposition, with most of the main spaceports covered by Coalition security. Newly arrived insurgents to Chara may need training—and there's always a guerrilla war to fight.

### NEXT TRACK

*Death to Tyrants*





EARLY 3078: SMASHING THE WALLS 



## EARLY 3078: SMASHING THE WALLS

By the start of 3078, the allied Coalition led by Devlin Stone had done more than solidify itself as a military force. Acting in unison, its disparate troops had launched a successful campaign to overcome the Word of Blake's "Maginot Line"—a string of key outer-Protectorate worlds reinforced with Protectorate and regular Militia, and fortified with defenses similar to the Castles Brian of the Terran Hegemony. With these hard-points shattered, the Word of Blake would be hard-pressed to reinforce Terra itself for the coming invasion, but even so, the allies were thorough.

For the early half of the year, Coalition forces continued to whittle down the number of Protectorate worlds remaining, shattering Blakist defenders and clearing out as many collaborators as possible before moving on. In their wake—often overlooked—came a corps of volunteers dedicated to rebuilding the fractured governments, providing vital medical and economic aid to repair the infrastructures broken by a combination of neglect and malice.

In the grand scheme of interstellar history, the Word of Blake's ten-year reign may seem inconsequential, but to the liberators and the aid workers who followed after the Coalition's victories, the changes were dramatic. A combination of relentless propaganda, revivalist nationalism, and brutal persecution of all opposition, transformed the cultures on these worlds from mere slivers of the Great Houses they once served into a twisted approximation of the long-lost Terran Hegemony, beholden to Terra itself. All but erased were the loyalties to Successor State lords; these populations now agreed to the Blakist "logic" that the Great Houses had collectively raped and abandoned them for their own ends. Even as the occupation of the Word and its bloody consequences remain visible everywhere, these people have come away awakened to an older shared legacy—one that predates the Succession Wars. Where they may once have been Davions, Kuritas, Steiners, or even Liaos—many of the survivors within the Blake Protectorate now see *everyone* as an invader to their common lands. It is camaraderie unique to the victims of these years of repression, and a clear challenge to those who come to pick up the pieces now that the Word's power is lost.

After all that has happened, will these worlds ever return to the way things were?

## LYRAN FRONT

### 3077: WAR IN REVIEW

(1 January 3078)

Thorin [INN] — [*Myra Kellison sits in front of a decapitated Lyran war memorial.*]

"Happy New Year from Thorin. This is Myra Kellison with INN.

"It has been about a year since the invasion of the Jihad

## SMASHING THE WALLS

Protectorate began in earnest and the allied Coalition has made significant progress. With Devlin Stone coordinating the overall campaign, the task force under the command of Duke Robert Kelswa-Steiner has performed superbly. In addition to the major stories and victories you have heard about, this task force has brought freedom to five other worlds.

"Last March saw the horrors of Summer revealed, but it also marked the initial landings to free Mizar. Despite having bolstered their forces with salvage from the Protectorate Militia on Yorrii, Lyran, Wolf and Combine forces wore down the outnumbered defenders. It was a tough fight, but not nearly as damaging to the

## PANDEMIC ON SABIK

(10 January 3078)

Sabik [DBC] — [*An elderly gentleman sits behind an antique desk. The caption below reads "Bamin Taylor, DBC."*]

"...and from the Blakist front, there is more terrible news. The world of Sabik is suffering a pandemic that is threatening to kill off all the inhabitants. The recently liberated world was thought to have survived the Jihad relatively unscathed after Coalition forces landed without a fight. But sadly, the Blakist defenders simply melted into the civilian populace only to return again with violent guerrilla action.

"Widespread fighting and public backlash has killed thousands over the course of several weeks—including Blakist insurgents—and caused significant damage to the planet's HPG station and other public services. Then suddenly, it seemed that nature itself conspired against the liberators and survivors.

"A few weeks after the fighting died down, a large portion of the Sabik population, centered in the single major city of Mofestos, began suffering from a fast-spreading neurological disease. Unable to call for help, Sabik's provisional government marshaled its local scientists and discovered the epidemic to be a rare form of viral encephalitis.

"Further studies show that the strain was one thought dead for centuries: Downing-Poltur's Disease. Marked by a massive shutdown of logic functions and random acts of violence before swelling of the brain kills the victim, the disease is highly contagious; there is no known medical treatment. It can spread quickly, especially in the close confines of the native settlements, and Sabik's medical infrastructure has so far been unable to contain it. The disease has been rampant for over a month before arriving vessels have been able to warn about it.

"Sadly, Sabik's desperate call for aid may have come too late. As war continues to rage on all fronts, it is a wonder if any amount of help can arrive in time.

"Our prayers are with the brave souls on Sabik."

—*Video reposted to DBC news network; originally broadcast via unconfirmed independent service*



## FINANCIAL CRAP SHOOT

**[Voice (ID: Carol J. Sterling)]:** "Yes, I'd like to know where to invest some money I got from my father's inheritance."

*[A severely overweight and sweaty man leans over a desk, the background a seething mass of people on the Donegal Stock Exchange floor.]*

**[Voice (ID: Darrell McLaughlin)]:** "Excellent question! Now is a good time for long-term investments, but it's a short-term bear! The big thing you need to look at right now is cash flow and credit. Go, go, go with Nashan. Big and bad, they'll bounce back from the loss of their shipyards and their insurance losses. Remember, their computer division survived the Coventry occupation back in '58 and again in the early '70s. Pharma and Architectural alone will get them even in no time. I also like ComPress, and even TMA will do well as people want current events."

"Now, Looking to the military giants..."

*[Background transforms into battlefield footage.]*

**[McLaughlin]:** "Unless you are looking fifteen years down the road, avoid Defiance Industries and Coventry Metal Works. Both the Hesperus and Coventry 'Mech factory complexes got mashed and will take a while to rebuild. StarCorps is a different matter. Other than their losses on Alarion, they came out good and have branches everywhere. Any company that's involved in construction is a good buy, as are companies on the Falcon border, where the Clans have taken a beating lately.

"But unless you're saving for retirement, young Carol, generally avoid any military stocks heavily involved in Coventry, Hesperus, Tharkad, Alarion or anything based in the Protectorate. Look to Furillo or my personal favorite, Clinton."

—From *McLaughlin's Power Hour*, DBC, Donegal, 2 February 3078

system. Sadly the same was not true for Wing just two months later. The Third Free World Guards were ready and savaged the Sixth Benjamin Guards, while the First FedSuns Lancers was incapable—or unwilling—to keep up a flanking advance. Another few weeks of hard fighting won the world, but the Third fled to Regulus and were reportedly given asylum there.

"Needing a good break after this, the task force got one. The Seventeenth Arcturan Guards went to raid Zosma and found it nearly undefended. They quickly crushed the opposition and the planet surrendered. Similarly, Lipton was freed in November as Duke Kelswa-Steiner quickly crushed the opposition. Here on Thorin saw an assault by the Third Group, but with the Sixth Benjamin barely operational after the fighting on Wing, they were unable to make headway against a heavily dug-in enemy. Fortunately, a Dominion raid distracted the Blakists and the Duke was able to make a push that secured victory.

"From a free Thorin, I'm Myra Kellison."

## SMASHING THE WALLS

## PHECDA: TRAGEDY AND TRIUMPH

(14 February 3078)

Phecda [SBC] — Duke Robert Kelswa-Steiner graciously allowed us an interview on Phecda, following the dramatic victory there by the Lyran Thrust's Group IV. Here is a partial transcript; watch for Marlena's full video interview on SBC One.

**[Marlena Stockheart, SBC]:** "Duke Kelswa-Steiner, our condolences for your losses, as well as your injury. Was your decision to relinquish command based on the loss of your leg in battle?"

**[Duke Robert Kelswa-Steiner]:** "Well, I would be lying if I said no. To be parted with your own flesh and bones...it's a hell of a thing. You can appreciate the loss on an intellectual level, but I can tell you I have a whole new perspective of the kind of sacrifices our sons and daughters have had to make for Skye and the Lyran Alliance.

"But emotional burdens aside, there are also operational concerns. The doctors tell me I am still weeks removed from a full recovery, as I sustained several other injuries as well. The demands of a task force commander are many, and the hours are long. We simply cannot afford to have our offensive suffer simply because I'm not operating at peak efficiency. The only sensible step was to immediately reassign overall command and become a part of the staff."

**[Stockheart]:** "Some question your decision to assign your son as your replacement. Would it not have been more logical to assign the task to saKhan Ivan Kerensky, your current second-in-command?"

**[Kelswa-Steiner]:** "That would be true if my *only* reasons for assigning Gregory were simple nepotism. But Gregory has had several opportunities during this war to prove his capability. He has been an instrumental part at every stage of planning of our offensive, and everyone on the staff—including the saKhan—has been impressed with his grasp of strategy and logistics. He was the best candidate among many in my command on merits alone, a fact that saKhan Kerensky fully understands.

"Furthermore, in this task force, we run a delegated command structure, and the second-in-command has very specific duties. If I were to assign the saKhan the task of overall commander, someone else would have to transition into his function as well, increasing disruption, and reducing our effectiveness. Given that we have lost so many of our command here on Phecda, anything we can do to reduce distractions will improve our ability to begin the next stage of the assault."

**[Stockheart]:** "I see." *[Pause.]* "Have you considered a cybernetic replacement for your leg? Would you resume overall command at a later date when you've recovered?"

**[Kelswa-Steiner]:** "I'm trying not to think about the leg right now. I've opted out of getting a replacement limb for the moment. That's a decision best left for when I return home after all of this, and to what extent it will affect my responsibilities to serving Skye."

## EARLY 3078: SMASHING THE WALLS



"As to leadership, I do not believe in reversing my decisions; the disruption caused by resuming my role at a later date is better left avoided, especially if it comes in the midst of our final drive on Terra. Gregory will perform admirably, and I will continue to contribute as an advisor. But overall, my duties from here will be a bit more rear-echelon, coordinating logistics and the recovery and rebuilding efforts on liberated worlds."

**[Stockheart]:** "Do you believe the losses on Phecda and the changes it has forced have reduced the Lyran Thrust's ability to complete its objectives?"

**[Kelswa-Steiner]:** "I don't want to downplay the losses we have sustained. We lost many brave sons and daughters from Skye and elsewhere, a lot of talented individuals. But the rest of this offensive remains strong, and there is a lot of depth on our bench—if you'll pardon the sports metaphor. So while it may slow us down while we adapt, ultimately we have the means and we have the people to complete all our objectives despite the Blakists' worst efforts."

**[Stockheart]:** "Thank you for your time, your grace."

**[Kelswa-Steiner]:** "My pleasure."

**FAILED GAMBIT?**

(12 March 3078)

Skye [Skye News] — With the retreat of all Clan forces confirmed, it appears that New Earth will remain in the Blakists' grasp for now. Despite deploying roughly four Galaxies of troops, a combination of Wolf, Jade Falcon and Ghost Bear forces were unsuccessful in taking this key world from the Word's grip. The battle began with high hopes, but early reports from the naval engagement soon claimed the losses of anywhere between one and four Clan WarShips with "at least one" Word of Blake vessel confirmed destroyed. New Earth's SDS network, an anticipated obstacle, was also reportedly destroyed or at least heavily damaged in the process.

On the ground, additional reports indicated the near total destruction of at least one Militia Division, along with the majority of the New Earth PM, but the presence of an unexpected Shadow Division tipped the balance against the Clan troops. Alleged use of WMDs in the fighting has not been confirmed.

Analysts agree that a second concerted assault on New Earth is almost guaranteed to succeed. Given the importance of the world as a probable staging area for the assault on Terra, some say that such a follow-up attack is imminent.

Perhaps even more curious are recent statements, made under condition of anonymity by members of Duke Kelswa-Steiner's staff, indicating how timing and coordination may have been a factor in the Clans' defeat. According to one source, it took some time on New Earth before "appropriate synergy was achieved between the various Clans." Another source indicated that the Ghost Bears arrived well ahead of schedule and began the offensive, declining to wait for Wolf and Falcon forces.

If true, it is possible that the presence of three Clans on New Earth was not as pre-planned as Coalition commanders have claimed, and that Duke Kelswa-Steiner may have actually hoped to sneak the world away from another rogue Ghost Bear assault force.

**REST AND REFIT**

(1 June 3078)

New Earth [INN] — *[Image opens on Myra Kellison; behind her is a busy mess hall with a myriad of uniform colors.]*

"Myra Kellison for TMA on INN from New Earth, where the order of the day is simple: catch your breath."

**ALARION: WORLD IN RECOVERY?**

(7 April 3078)

Alarion [DBC] — Welcome to Alarion orbit, where—nine years ago already—tragedy struck. A fleet of WarShips under Word of Blake banner descended upon this helpless planet and wiped out a thriving civilization in a matter of minutes. Nuclear apocalypse rained down on the inhabitants, followed by a custom-tailored cocktail of biological agents aimed at the entire ecosystem. Millions died in the initial blasts, followed by billions more mere weeks later, succumbing to radiation poisoning or a cocktail of viral diseases. And then there was silence.

Donegal Broadcasting is here today to see what has become of this ravaged world, once a powerhouse of the Alliance naval industry. Since no official statements have been released beyond the initial quarantine announcement by the LEMC, we decided to do some investigating on our own.

With me on this vessel is a full suite of high-tech sensory equipment. For the last three days, a team of system specialists used this equipment to detect transmissions leaving the planet. So far, they have mapped an extensive network of satellites broadcasting—*absolutely nothing*. A brief spark of hope flared up yesterday when additional surface scans picked up a strong signal in the northern hemisphere. But this too, turned out to be just a steady stream of static being bounced back and forth between two relay stations operating on emergency power systems.

We will continue our orbital search for two more days, but it seems a landing will be unavoidable to find out more. Due to quarantine restrictions, no civilian vessel is permitted to enter the Alarion atmosphere, as it would result in almost certain contamination and eventual death.

Or would it, really? Once more, current information is withheld by official sources. The sole signs of any government interest is a couple of lonely SkyWard warning satellites scaring unwary travelers off.



## EARLY 3078: SMASHING THE WALLS



"This task force has taken some severe abuse. No command has been immune to the brutality of this campaign, but there certainly are a few who have suffered more than their fair share of damage." [*She sweeps her hand in the general direction of a few groups of soldiers wearing similar uniforms.*] "Topping the list are the survivors of the Kell Hounds and the Com Guard's First Army; less than a quarter of either force has survived the fighting so far. The Sixth Benjamin was also hurt by lack of support, though they received an influx of DCMS troops and equipment.

"The LAAF forces on this front have performed well, and been rewarded with relatively few casualties because of it. The Seventeenth Arcturan is still over half-strength, as are the Skye Guards. Of course, avoiding combat has also helped the First FedSuns Lancers, while the Clans have taken a lot of abuse. But despite the politics and the factionalism still evident, morale is high. We are winning this war, and the end is almost in sight.

"Here on New Earth, preparing for the next step, I'm Myra Kellison."

### TRAITORS OR OPPORTUNISTS?

(5 June 3078)

Rigil Kentarus [DBC] — Clan Wolf's Delta Galaxy and the Jade Falcons' Alpha Galaxy departed from Rigil Kentarus today, after staging several "Trials of Possession" with Clan Ghost Bear for the goods captured by Coalition forces during the liberation.

While the initial exchanges between Clan forces were explained as an extension of their "interactions during the assault on New Earth," it has since become clear that the Clan troops have been extremely reluctant to share their "isorla" [*Ed— Captured supplies and equipment*] with other Coalition forces. This possessiveness does fit into the egocentric mindset of the Clans, for whom teamwork and cooperation with outside entities—even between other Clans—is counterintuitive. It is also very counterproductive, a statement numerous experts on Clan culture agree with, and which is certainly true here. With an equitable redistribution of captured war supplies absolutely critical for maintaining the momentum of the assault, the fact that the Clan forces involved feel it necessary to stage Trials for ownership is a disturbing trend.

It is not strange then, that some have begun to wonder aloud whether the Clans should at least be reprimanded severely for behavior that betrays the goals of the Coalition they joined. When their cultural perversions begin to interfere with operational demands, surely *something* must be done.

Others have begun to wonder whether the Clans are not

just being opportunistic with the supplies they confiscate, but whether they are also laying the groundwork for a new Clan invasion by depriving Inner Sphere forces of supplies. Could the Clans be the proverbial vipers in the Coalition's nest, waiting for the chance to strike and lay the entire Inner Sphere low?

### ASSASSINATION PLOT

(13 June 3078)

[*Video opens on Myra Kellison outside a Gothic-inspired building at night.*]

"This is Myra Kellison with late breaking news. An assassination attempt here on Altair against Marcel Webb, chief of security for the Coalition and commander of the Star Seeds mercenary unit, was foiled this evening by fast-acting security. The attempt failed but left two men dead before the would-be assassin escaped the scene. Coalition security is characterizing this as a Word of Blake assassination attempt.

"The attempt began hours ago, during tonight's reception for the Coalition commanders who recently liberated this world. Killing one of the local wait staff, the assassin apparently took his place and entered the main chambers, where Devlin Stone and Duke Steiner were to be addressing the audience regarding the state of the Lyran front against the Protectorate. Instead, Coalition security chief Marcel Webb appeared at the last minute with a special announcement. At that point, the assassin drew a concealed needler pistol and attempted to shoot Webb at almost point-blank range. As he aimed, Stone's personal bodyguard, Pedro, stepped in front of the shot and returned fire. The assassin was hit by at least two shots and escaped. Pedro died from his wounds at the scene.

"Altair authorities are looking for a man roughly 167 centimeters in height, of average build and white-gray hair. He was last seen wearing a waiter's tuxedo and is considered armed and extremely dangerous.

"A question on many investigators' minds is, 'who was the assassin's real target?' Certainly, Webb is important to the Coalition, but hardly vital enough to waste such a rare opportunity on, nor was his appearance anticipated tonight. Or is it possible the assassin took a shot a lesser target only after realizing that the evening's altered schedule had 'bumped' his true mark? Was the Word after Stone or Duke Steiner? Either leader's death would certainly benefit the Blakists at this point. Perhaps when more information is available, the true story will come to light.

"From a shocked but still functioning headquarters on Altair, I'm Myra Kellison."



## EARLY 3078: SMAS

## DRACONIS FRONT

### THREAT CONTAINED

**[Osaka]:** "Welcome back, I'm Sako Osaka, and this is your 2300 news brief. Earlier this evening, Terri Chow reported on a supposedly leaked report from one of our intelligence services, presumably the O5P. It is the policy of this station and ISNS not to broadcast unsubstantiated and unsolicited information. However, in light of the subject this report, we have reason to believe its authenticity. With more is Terri Chow."

[Cut to a young Asian woman in front the Ministry of Information Annex.]

**[Chow]:** "This is Terri Chow, reporting for Voice of the Dragon. I'm standing outside of our Information Ministry, where I just conducted an interview with an official who must remain anonymous. My source informs me that the disturbing events reported from Qandahar were, in fact, perpetrated by the outlawed 'Black Dragon Society.'

"My source alleges that local security forces lost a number of operatives in an attempt to quell an uprising instigated by suspected Blakist insurgents. Apparently, the security forces were wholly unprepared for the tactical situation. In addition, the Black Dragons may have received support from local conspirators. Furthermore, according to sketchy reports from the Qandahar Prefecture, petroleum plants and production facilities on Qandahar are assumed to be in the hands of the outlaw terrorists.

"Reportedly, O5P and ISF are stifled in how they should proceed from this point. Because of the ongoing Jihad, security assets have been stretched thin, and local operatives do not have the ability to properly contain the Society's resurgence, despite reassurances from the ISF. My source alleges that the use of military intervention is being discussed as an option. If so, the Tenth Pesht Regulars are the only available force in the Prefecture if such an option is used."

—VOTD broadcast (now removed), Benjamin, 21 December 3077

### SAVING DRAGON BACON

(27 January 3078)

Buckminster [DRAKE] – Long Live the Dragon! Thanks to the determination and bravery of the Second and Eight Dieron Regulars, the Dragon's banner yet again flies over the heart of the Dieron Military District. Almost single-handedly did they conquer Fortress Dieron, and routed the dozen of Word of Blake Divisions. The only aid came from a couple of Ghost Bear warriors who were privileged enough to be allowed to witness these feats of glory. And in the skies above, the might of the Draconis Combine Admiralty showed their skill by defeating the Blakist WarShips with minimal assistance.

This is the propaganda the Dragon *wants* you to believe. They want to reinforce the strength of our realm and the idea that we

## FLIGHT OF THE RAVEN

(9 January 3078)

Dieron [Drake] – The following are transcribed excerpts from the logs of Star Admiral James Lankenau. Don't ask where we got them:

**8 Oct, 13:00:** *Ark Royal* made the jump successfully and joined *Leviathan* and *Ursa Major* on the approach to Dieron.

**10 Oct, 18:00:** Resistance to our approach to Dieron has been eliminated; only a handful of aerofighters and four assault DropShips present.

**11 Oct, 08:00:** The invasion has begun, Ghost Bear forces have secured landing zones with minimal losses and are starting to engage the Blakists.

**20 Oct, 22:12:** Progress on the ground is slow but steady. Enemy well-entrenched in positions which gives little room for orbital fire support.

**19 Nov, 04:37:** Sensors have detected several incoming drive plumes, later confirmed as capital class vessels, and approaching under heavy EMCON. Conference with Star Admiral Gilmour on the *Leviathan* to discuss situation.

**19 Nov, 14:00:** We will meet and engage the hostile. The Watch indicates a high probability that this is another maneuver like on Dyev, drawing us away to insert troops. But faced with six WarShips, Star Admiral Gilmour feels we need all vessels against them.

**20 Nov, 06:48:** Screening forces have engaged. Enemy has been identified as FWLN *Sardis*, FWLN *Aineas*, FWLN *Mordred*, FWLN *Tristam*, WoBS *End of Wisdom* and WoBS *Light of Glory*, along with plenty of assault DropShips.

**20 Nov, 07:32:** FWLN *Aineas* destroyed. *Leviathan* taking heavy damage from entire enemy fleet, despite ECM and other harassing forces.

**20 Nov, 07:36:** WoBS *Light of Glory* and FWLN *Tristam* destroyed. *Leviathan* heavily damaged, *Ursa Major* trying to intercept Blakist Pocket WarShips targeting the *Leviathan*.

**20 Nov, 07:40:** *Leviathan* is disabled, Pocket WarShips still raking her sides with fire, ignoring the fire from *Ursa Major*. Ghost Bear forces are going berserk.

**20 Nov, 07:45:** FWLN *Mordred* and WoBS *End of Wisdom* both destroyed, FWLN *Sardis* disabled and ejecting crew.

**20 Nov, 08:35:** Main fighting is concluded. The *Ursa Major* has received moderate damage, the *Leviathan* seems lost, and the *Ark Royal* has sustained light damage. The Ghost Bear aerospace forces have been gutted, only about a fourth of their fighters are operational, busy hunting down stragglers. Majority of invading ground forces made planetfall, Galaxy Commanders have been alerted.

**2 Dec, 19:00:** Report to Khan McKenna. *Leviathan* has proven unsalvageable; Ghost Bear forces are preparing to scuttle the vessel, ensuring its remains are never tainted. The *Thera* can be repaired; we have claimed it as salvage and are naming it the *Raven's Nest*. A dedicated carrier is of use to both us and the Alliance.

## EARLY 3078: SMA

can—and will—stand firm to defeat our enemies. While in itself this is a noble goal, it's sheer idiocy to try to project strength when there is none to be had.

The simple facts are that the Dragon was barely allowed to even *join* the assault on Dieron; the Ghost Bears had to be persuaded by Devlin Stone to include them! Even then, the Dieron Regulars took a back seat in the real fighting, which was done by the four Galaxies of Ghost Bear warriors. Above the skies of Dieron, the Clan fleet took on the Blakist WarShips—even sacrificing one of their biggest vessels, a *Leviathan* battleship, to the Word's fleet before they could claim victory.

And on the ground? Our troops couldn't even cooperate with our allies. Instead, they clashed with the Clanners on several occasions, leading to unnecessary loss of life on both sides, while our mutual enemies laughed at them.

And when the fighting is done, and only pockets of resistance need to be cleaned up, does our proud DCMS step in to do so? No! *Mercenaries* in the form of the *Northwind Highlanders* are brought in to mop up, so that Marik and Steiner militia forces can now garrison Dieron!

If we cannot defend ourselves, liberate our own worlds, what good does posturing and stuttering do us? *Clanners* liberated Pesht! *Clanners* saved Luthien! *Clanners* freed Benjamin! And now, *Clanners* have taken Dieron back from the Word of Blake! What if someone garrisoning these worlds for us decides to keep them? Can we withstand another incursion from the Snow Ravens if they find some new imaginary plot we've perpetrated against them? When will we be able to stand proud and strong again—a force feared and respected by our neighbors?

When will our strength actually *match* our words?

### SPIRIT OF COOPERATION

(22 March 3078)

[INN: APPROVED FOR RELEASE, Location Classified]

"Stone's Coalition"—as it is called cordially—celebrates victory after victory. It seems as if humanity has finally overcome all its prejudices and formed one body to free itself from a great scourge. All five Houses march together, side-by-side with Clan troops—the enemy we all stood against before the Word of Blake managed to unite the Inner Sphere against themselves.

Throughout the Sphere, concern was voiced at the onset of this endeavor, but quickly silenced by the winning personality of Devlin Stone. So the façade goes...

After over a year of coordinated missions I ventured to find out what the troops think and how the men and women who live this joint venture perceive this culture of cooperation in their daily lives. The response to my inquiries was overwhelming. The conclusions at the end? Not so much.

Let's start with the positive aspects. For one, the system *does* work, as evidenced by the campaign's success. The Coalition proves that interoperability is indeed possible.

## BLACK DRAGONS CONTAINED

>>DCMSHIGHCOMMAND//LUTHIEN//

PRIORITY:YELLOW<<

KORR.SITUATION RESOLVED. ARRIVAL OF 2 AN TING ASSISTED IN TIPPING THE BALANCE. BDS LDRSHIP DISPOSED AFTER UNKNOWN CAUSATION; POSSIBLE INTERNAL POLITICS TURNED BLOODY. 10 PESHT SEIZED INITIATIVE AND HELD DROPPORT FOR 2 AN TING LANDING. CASUALTIES MODERATE. ORDER RE-ESTABLISHED. REQUESTING FULL INQUIRY AND POLITICAL COUNSEL TO BEGIN DAMAGE CONTROL. OIL AND MINE PRODUCTION DOWN 85% FROM INTERNAL SABOTAGE. 70% REFINERIES OUT OF COMMISSION OR AFLAME. ENVIRONMENTAL IMPACT UNKNOWN.

AWAITING ORDERS FOR 2 AN TING AND 10 PESHT TO PROCEED INTO REST OF PREFECTURE.

>>05P.PROTOCOL.YELLOW.BLUE.ROKU//DISPATCHED  
28 MAR 78//RECVD<<

—Posted on the Drake/An Ting underground press server, 9 April 3078 (veracity unconfirmed)

As always, the devils are in the details. Members of the Clan forces complain the loudest: About dishonorable fights, unworthy targets, and generally about anything that strays from their own code of conduct. Since our task force is under chief command of DCMS forces, these complaints are not entirely without basis. Honor, integrity, and reputation on the battlefield still guides a lot of decision-making officers, who then assign the more prestigious missions primarily to Combine units.

All is not well with our Federated Suns brethren as well. While the almost-eternal enmity has not erupted yet, word is spreading that Davion units are not being serviced too well in downtime. Inconveniences—nothing that endangers the mission in general, but little pebbles on their daily path—wear down at their morale. Three times the same meals, no extras. Supplies always just in the "nick of time," never a comfortable second before. Or the way the victory-parade photographer always disappears just before the non-Combine units march through.

These frictions should not go unaddressed by the representatives of the Dragon, or else greater chasms might form. And that is something we cannot allow to happen so close our final goal.

—Orson Tanaka, Media Diary, Entry #98

### FOMALHAUT, EPSILON INDI LIBERATED

(4 May 3078)

Fomalhaut [VOTD] – Today the Dragon stands at the doorstep to Terra. Less than thirty light-years' distance—a single jump for the Dragon's WarShips—would bring the *Kanrei's* forces face to face with the defilers of Benjamin, the destroyers of the Black Pearl. With the hard fought liberation of Fomalhaut, the DCMS can draw a line from Altair to Epsilon Indi. Only Caph stands between our forces and the world whose fall will free the Draconis corridor from the hated Word of Blake.

## EARLY 3078: SMASHING THE WALLS

Fomalhaut is free today, thanks to the skill and heroism of the Genyosha. After months of bitter fighting between Coalition forces and the Word, in which both sides showed a wanton disregard for human lives, the *Kanrei* ordered the Genyosha in to finally free the world. Sadly, this freedom did not come in time to save the planetary capital and hundreds of the scenic places of beauty that made it a gem in the Dragon's crown for so long, but at least now its people will know peace.

On Epsilon Indi, the First Sword of Light was the spear into the heart of the Blakist rot. Yet for all the heroism of our best warriors, the victory has not been without sorrow. Already a world of stark deserts, empty seabeds, and centuries-old, bombed-out ruins, the people of Epsilon Indi face possible extinction from an insidious biological weapon. With the worlds' primary water supplies tainted, this world will need water shipments to even meet their basic living needs.

In comparison, we can sing our praises for the near-bloodless victories on Altair and Northwind. With these worlds free and the Dragon refreshed, Terra will soon fall. We give honor to *Kanrei* Kiyomori Minamoto and his tireless drive to bring security to our realm once more.

**WHAT LIES AHEAD**

(7 May 3078)

Altair [VOTD] — With Altair now firmly back in the Combine's fold, all eagerly wait to learn the next step in the offensive against the Blakists. With so many troops now amassed just a single jump from Terra, it is likely that many consider humanity's home to be our next target. This assumption is further bolstered by the furious efforts to repair, re-arm, and revitalize the task force after their many months of constant campaigning.

The question then becomes: are *Kanrei* Minamoto's troops ready for that challenge? While the answer to that question depends on many factors that cannot be known until they launch towards the Sol system, we can observe past performance. Certainly, when regarding the tragedy on Quentin, and the action on Dieron, one can only be re-assured that the *Kanrei* will do what must be done to ensure the victory and continued prosperity of the Dragon. Truly, it is difficult to find any flaws

**IN THESE MATTERS**

To the honorable warriors of the Arkab Legion:

Your courage and sacrifice will never be forgotten. The innocent blood that ran during the last several months cannot be undone nor can it be denied: the Azami people have suffered greatly under the xenophobic prejudices of those who claim the Dragon's ancestry, but hold to none of its honor or ideals.

It is with great pride and a humble heart that I thank you for your sacrifices and the honorable actions of your Legions in protecting one of the precious souls of the Dragon. It is with equally great sorrow that such honor and life must be wasted by the actions of the misguided and lost.

In these matters, truly you have shown the House of Kurita and all its citizenry that you are true safeguards of the Dragon's spirit. The Dragon cannot be whole without the facets within. It is truly with pride and humbleness that I reaffirm that its core can be seen within you, our brethren.

The Dragon honors your sacrifice.

—Private message from Coordinator Hohiro Kurita to each member of the First Arkab Legion, 17 April 3077 (posted to the Drake/Pesht server on 19 May 3077, veracity unconfirmed)

in his strategies and tactics so far, and the task force has been able to adapt to various Blakist tricks with speed and poise. An exception to this can be found on Fomalhaut, which no doubt has become a learning experience.

The concern, then, is what lies ahead. Certainly, when taking into account the massive resources the Word has committed to dozens of its captured worlds, it is only logical to presume the defenses on Terra will dwarf anything that has been experienced by the Coalition so far. Few have forgotten the convincing defeat of Case White those many years ago, and it is safe to say that Terra's defenses will have only improved since then.

Another concern that cannot be ignored is what stands next to us. The mystery of the Northwind Highlanders continues, and many are concerned that their unique situation can only be properly explained as an elaborate Blakist ruse. Could the Highlanders be a second Broadsword Legion? Is it then truly wise to rely on the Highlanders in any capacity during the final battle that lies ahead?

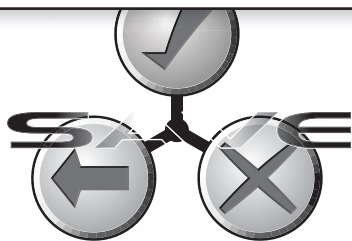





## THE CASE FOR LEADERSHIP

—Excerpted from QWR public forum logs, New Samarkand, 30 June 3078 (veracity unconfirmed)

[RUMBLEB105: 01:22]

>>Excerpt commences:<<

*Kanrei* Minamoto, with respect, you must press to have first rights at selecting an invasion corridor. This will position us to greatest effect when establishing permanent beachheads. Then we can fortify our positions on Terra and prepare for the Blakists' inevitable defeat. Think bigger, my liege. Think long game.

- Abbey

>>End Excerpt<<

[SUN66LVr: 01:25] I did *not* just read this!

[QENT282HiYA: 01:27] This is heavy. Rumbleb105, where the hell did you get this? Sounds classified.

[RUMBLEB105: 01:28]

>>Excerpt commences:<<

...ve also backed-off as agreed. You should have the breathing room to pursue our mutual goals.

Attached is the information you requested. There was not much but we did find...(data corrupted)...Kittery.

I have high confidence in its veracity. Use it to the fullest effect.

Poising us, and by extension, the Dragon, for the greatest benefit during the invasion should be your top priority. Think bigger than your current seat, *Kanrei*. If not, the... (unrecognizable).

-J

>>End Excerpt<<

[SUN66LVr: 01:31] Come on! There is no way this stuff is real. Admin?

[QENT282HiYA: 01:32] OMG! This *is* classified.

<<FORUM-ADMIN0258 has entered the chat room, 01:32>>

<<QENT282HiYA has left the chat room, 01:32>>

[FORUM-ADMIN0258] SUN66LVr what seems to be the problem?

[RUMBLEB105: 01:34]

>>Excerpt commences:<<

*lie, tono*. The situation is entirely unacceptable. Our forces *must* be the very first to touch ground. It is a matter of honor. If we are to stake a claim then there can be no question, either of right or leadership. We must be there first and with everything we can muster! We have the strongest claim through historical precedent.

The Star Lea@#^(corrupted)...cannot prevent...(data missing)...

...then perhaps another should lead? You or even Hohiro are the obvious choices. I respectfully request to...

>>End Excerpt<<

<<FORUM-ADMIN0258 BOOTED USER RUMBLEB105, 01:35>>

## SMASHING THE WALLS

## FEDERATED FRONT

## EPSILON ERIDANI LIBERATED

(22 February 3078)

Epsilon Eridani [FSNS] — Today, another world is free of Word of Blake oppression. In a lightning attack, personally directed by Marshal Jon Davion, FedSuns Group II has freed Epsilon Eridani. Using an integrated combined arms sub-orbital/atmospheric drop strategy, which Davion pioneered in his time as a Sakhara instructor, the Coalition forces decapitated the Word of Blake's command structure in the first twenty-four hours. Within a week, all but the smallest pockets of resistance had been put down and civil leadership had been restored to the capital.

The liberation continues to underscore the success of the FedSuns thrust, which has now pushed over ninety light years into Blakist-controlled space in a little over a year's time. The near seamless transition from Marshal Sandoval-Ito to Marshal Davion likely indicates just how involved the Federated Suns' Marshal of the Armies has been in the strategic planning. While some of my fellow reporters have given the majority of their praise to the FedSuns commands within this offensive, it is clear now just how much effort has been given to a truly integrated Coalition force.

Nothing is a more striking sign of that integration and the ability of soldiers to get the job done, than a North American-style football match I watched yesterday. One side was made up of a mostly Lyran offensive line, a quarterback from ComStar, and runners and receivers from the Benjamin Regulars. The other side was primarily members of Clan Nova Cat's Delta Galaxy, but with several members of the small mercenary unit Drake's Drivers filling out their flanker positions. One of the finest and most sportsmanlike games I've ever had the joy to watch and a true testament to a soldier's ability to ignore politics and just focus on what needs to be done. It is a testament to the ability of the commanders of the Suns thrust to have such disparate forces working well together.

## AND A DAVION TO LEAD US ALL

7 January shall be a day always remembered, the day that Robinson lost one of her finest generals. Marshal Katheryn Sandoval-Ito was a hero and symbol of all that the Draconis March and Robinson represent. With a career spanning back to before the 3028 war...

...Marshal Sandoval-Ito's death was indeed a foul blow to the Federated Suns, but we can all hold our heads high in the knowledge that she died fighting for the lives of her men and the freedom of us all. The images of her *Devastator* being dragged to the ground by Word of Blake *Se'irim* and Purifier battle armor are truly heart wrenching. The knowledge that her final actions saved dozens of her people, as well as an entire city's worth of civilians, allows us all to bear the pain of those images.

## DIRE STRAITS

**[Oathmaster Minoru Kurita]:** "Star Admiral Erik Devalis, my visions are dire of late. You have news regarding the liberation of Bryant, *quiaff?*"

**[Star Admiral Devalis]:** "Aff, Loremaster. I seek *surkai*."

**[Kurita]:** "Neg, I wish to hear your report first."

**[Devalis]:** "Aff, Loremaster. I set the task force in Omicron pattern, the *Spirit Vision* and the *Chronicle* leading and my own flagship, the *Severen Leroux*, providing close escort for the JumpShips. We arrived at the nadir jump point as planned."

[Long pause]

**[Kurita]:** "Tell me about the SDS. What went wrong?"

**[Devalis]:** "The Assault DropShip, AFS *Villegas*, exploded as a group of *Capital* and *Bastion*-class defense platforms opened fire on our arrival. Knowing we could not protect the transports and also fight the SDS, I ordered the *Chronicle* to escort them planetside while I screened them with the *Severen Leroux*, the *Spirit Vison* and half our fighters. We lost the *Spirit Vision* early to swarms of drones. Sadly, the *Severen Leroux* crumbled around me as we destroyed the last platform. I have failed the Clan."

**[Kurita]:** "Such terrible losses are not easily recouped. Could the *Chronicle* have helped prevent this terrible tragedy, *quineg?*"

**[Devalis]:** "Aff, Loremaster. But leaving the Spheroid transports was tantamount to a death sentence for them. It could have been far worse for the task force were they left alone to face even one drone. Still, I ask *surkai* for my failure and offer my resignation."

**[Kurita]:** "I see."

[Another long pause.]

**[Kurita]:** "WarShips may be replaced but the honor of the Clan is eternal. Due to your actions, the task force survived and Bryant was taken..."

"Your *surkai* will be to prepare a briefing for the Khan about these *dezgra* SDS systems. We must be ready next time."

—HPG communications intercept, Irece, dated 5 March 3078 (source and veracity unconfirmed)

The loss of so great a leader has the potential to destabilize the crucial Federated Suns thrust and threaten the entire drive to Terra. Fortunately, we have been blessed in that a worthy successor stands ready to fill Sandoval-Ito's responsibilities. The people of the Federated Suns can rest well knowing Marshal of the Armies Jon Davion, will take up Sandoval-Ito's flag and carry it to Terra. Davion, a hero of the Battles for New Avalon, has kept abreast of the offensive and we can all breathe freer knowing such an able man will complete the strategic visions of our most beloved Robinson native.

Thank you, Marshal Davion.

Marshal Sandoval-Ito's body will be returned to Robinson for formal burial and...

—Excerpted from an obituary for Katheryn Sandoval-Ito, Robinson Register, 2 March 3078

## SMASHING THE WALLS

## RECLAMATION IDEALS

[Video opens on Peter Remonde carefully picking his way through the edge of a debris field.]

**[Remonde]:** "The world is Bryant, the site was the Lantren Corporation Annex. But otherwise the scene I stand before could be any of a dozen worlds I've seen in this short and brutal offensive." [Remonde looks over the debris field, pointing to a pillar of smoke in the distance.] "The brutality with which the Word started this war has only increased as the rogue adherents of Jerome Blake fight against every meter of the Coalition's advance to Terra."

"I've reported from the Inner Sphere's battlefields for almost thirty years now, and never in that time have I seen a level of destruction equal to what I've witnessed in this last year. Rebuilding from this war will pale the efforts of the Clan invasion or even the FedCom Civil War. Perhaps only the original 'Liberation of Terra' and subsequent, centuries-long Succession Wars outdo the devastation I have witnessed. It will be decades before some of these worlds will be able to claim anything close to 'normalcy.' Indeed, for some worlds, there may never be such a thing again."

[Looking back to the camera, Remonde has a thoughtful expression.]

**[Remonde]:** "Something has to be done to right the wrongs of this war. I am reminded again of my father's own days, covering the 3028 war and the efforts made by Prince Davion and his new wife. We should all hope that the Princess-Regent will remember her mother's stewardship of the Sarna March, repairing the collateral damage from every hard-fought battle there. For these worlds to recover they will need that kind of help from New Avalon. It is not enough to simply liberate these worlds; we need to rebuild them. The people of these worlds need to know they matter as much as those of New Avalon, or Tharkad."

"From liberated—but still not free—Bryant, I'm Peter Remonde, FSNS."

—Report filed by Peter Remonde, FSNS, 3 April 3078

## REVENGE

(12 June 3078)

New Syrtis [NSC] — With the two-year anniversary of the Taurian attack on New Syrtis approaching, the equatorial lands remain uninhabitable. Hundreds of thousands are still starving from the loss of crops that still cannot be grown. Our March capital is still relying on outside assistance just to survive day by day.

And this destruction was not wrought by those we really expected it from.

So, while taking all this into consideration, should we finally turn our eyes away from the reflexively hated Capellans, who have not truly attacked us (unprovoked) in years? Or should we instead turn our gaze rimward, toward the Taurian Concordat, who flippantly employ nuclear and chemical weapons on not



## NEWS FROM PLEIONE

(7 June 3078)

Chesterton [NANS] — The military may feel they know what the public can and cannot handle, but they are wrong. These two memos were carelessly released with other documents from 3078 that we requested. We feel that the public has a right to know what is going on right outside our borders. Nor should the poor citizens of the Confederation be kept in the dark like young children. The Word of Blake is losing, but they are chewing up the less capable Capellans that Sun-Tzu Liao keeps tossing into his meat grinder.

TO: FIELD OP 4  
FR: M1-ADVANCE OP  
RE: PLEIONE

IN RESPONSE TO YOUR REQUEST FOR INTEL ON CC ACTIONS ON PLEIONE, OUR SOURCES SHOW THAT APPROX. HALF OF WARRIOR HOUSE MATSU KAI WAS LOST TO WOB PW NEAR PLANET IN FIRST ASSAULT ON 05/02/78. SURVIVING FORCES WERE SCATTERED AND INEFFECTIVE, POSSIBLY DESTROYED. EFFECTIVE NEWS BLACKOUT IN CC, POPULACE BARELY HOLDING TOGETHER ACCORDING TO MIO. PUBLIC PANIC MIGHT SEVERELY HAMPER CC WAR EFFORT. PERSONALLY TORN IF THIS IS GOOD THING OR NOT. HOLD POSITION FOR NOW. AWAIT FURTHER ORDERS.

TO: FIELD OP 4  
FR: M1-ADVANCE OP  
RE: PLEIONE

CC HAS SENT SECOND TASK FORCE TO PLEIONE. FIRST TASK FORCE WIPED OUT TO THE MAN. WARSHIP SUPPORT CLEARED WAY FOR SUCCESSFUL DROP. NO WORD ON NAVAL CASUALTIES, EITHER SIDE. AT THIS TIME, PLANET STILL CONTESTED. BLAKIST FORCE APPROX. 60%, CC LOSSES AT APPROX. 1 REG. PLUS 1-2 BATT. STILL NO WORD FROM OFFICIAL CC SOURCES, INTERNAL OR EXTERNAL. MIO ADVISES LEAVING MATTER QUIET FOR NOW. CIVILIAN CASUALTIES MOUNTING. POSSIBLE WOB REINFORCEMENTS EN ROUTE THERE. SHOULD MAKE YOUR LIFE EASIER. YOU ARE AUTHORIZED TO PROCEED WITH BLUE BEAR. GOOD LUCK.

only Federated Suns systems and population centers, but even the worlds they claim as “their own” worlds?

I say we show the Bulls what it would be like if the Suns *really* wanted to conquer their backwater systems, if we were *really* preparing to invade and kill their paranoid leaders. We all saw how a few militia units and a half-strength mercenary unit could humiliate regiment after regiment of the Concordat’s best troops when they were supposedly whipped into a berserker like frenzy. What is really stopping us now, once war with the Blakists is over and done with—and while other houses are rebuilding—from taking a handful of RCTs and showing them just how insignificant they are?

## SMASHING THE WALLS

The Taurians have made it clear with their words and actions for over the past decade that they have been spoiling for a throw-down with the Federated Suns. Why don’t we give them what they want, if only for the few months it’ll take to wipe their kind out forever?

**BRYANT FREED; MARKING TIME?!**

(15 June 3078)

Bryant [NANS] — It has been almost two months now since Marshal Davion declared all “organized resistance” to have come to an end on Bryant, yet still no progress seems to have been made towards recapturing other Federated Suns worlds.

To many, this state of affairs is disturbing in the extreme, especially after the campaign’s success to date. The combat for Bryant, a key Word of Blake staging area, was more difficult than planned, and included the loss of two Nova Cat WarShips. The losses to ground troops were even more substantial, with a whole battalion of ‘Mechs and a regiment of troops dying within an hour just outside the spaceport mere moments before the Marshal’s declaration.

Taking time to recuperate is sensible, but this lengthening delay on the Suns front is now taking on the feel of a full-fledged stall in the allied offensive. Even the Capellans are reportedly making better progress.

The risk of stagnation in an operation such as this is tremendous. Not only does it give the Word time to rally its defenses against us, or to divert resources towards other fronts against the Coalition, it also provides our Combine “allies” more time to “liberate” some of our worlds. (Never mind the Capellans, who have already seized the opportunity to turn their guns towards us while Blakists remain active in the same system!)

Prudence can be a valuable attribute to any general, but it is becoming increasingly obvious that we are now patiently waiting the war away. This reluctance to continue the attack is very frustrating for those of us who appreciate the strategic ramifications of not recapturing our own worlds—even when many of us still have family on those planets.

It’s time to get back into the fight, already!

**VICTORY AT NEW HOME**

(16 June 3078)

New Home [FSNS] — We have been given a glimpse of what we can expect on Terra and that glimpse has shaken this reporter to his very core. Where worlds like Bryant and Achernar provided an idea of the determined resolve we can expect from Protectorate Militia and mercenaries still fighting under the Blakist banner, New Home has shown us how that game is taken to a whole new level when we face off against the cyber-warriors of the Word’s Shadow Divisions.

The arrival at New Home nearly ended in disaster when we barely avoided the arriving Forty-fifth and Forty-seventh Shadow

## EARLY 3078: SMASHING THE WALLS



Divisions, who executed an incredibly dangerous pirate jump, barely light *minutes* from New Home's orbit. At the time, I was supposed to be meeting with Devlin Stone, for an exclusive interview, but by the time we were able to safely reach the planet, Stone and his personal forces fell under siege. While the Lament defended itself from the combined might of two elite divisions, I found myself a guest of the Battle Corps mercenary command, bouncing around the back of a Morningstar tank in a wild dash overland to cut off the lingering Forty-third Shadow from reinforcing its comrades.

In the end, Stone was saved by the sacrifice of the *Aegis*-class *Promise*. Though she exposed herself to deadly fire from the Word of Blake space forces, the valiant Coalition WarShip maneuvered within spitting distance of the WBS *Lioness* to deliver a dead-on-accurate orbital strike against the Forty-seventh's position. Caught in the open while attempting to flank Stone's defenses, the Shadows were cut in half.

Seizing the opportunity, Stone led his Lament out in a brutal counterattack that nearly finished the Forty-seventh's survivors, to link up with General Belle Lee's incoming troops. Stone then turned the tide against the Manei Domini, hunting down the Blakist elite even as they fled into the nearby cities. The next twenty-nine hours I was a personal witness to the brutal block-by-block battle that saw all the three Shadow Divisions virtually wiped out—but this victory did not come without a punishing cost. The Ryuken-roku and the Second FedSuns Armored Cavalry have been effectively destroyed, while the Battle Corps Legion and Clan Nova Cat's Sigma Galaxy suffered over seventy percent losses. Every other unit involved in the fighting was seriously mauled before the Word retreated from the world.

New Home stands free today, but the cost is one that may be too high to bear. If the Word fights this hard to hold onto New Home, how hard will they fight when the campaign reaches Terra? Does Stone's Coalition possess the resolve to continue? Do we have the forces to pierce the defenses that must surround humanity's home world?

## WHERE IS DEVLIN STONE?



(4 July 3078)

New Home [FSNS] – On a day that carries a historical significance for freedom, I am unfortunately left to ask “Where is Devlin Stone?” The Inner Sphere may not always see eye to eye with this enigmatic leader, but only a fool would try and deny that he has been one of the single most catalyzing forces in the war against the Word of Blake. I count myself among the millions who believe we would not be where we are today, on the verge of freeing Terra, were it not for the leadership of Devlin Stone.

So where is he? New Home had barely been declared free when Stone boarded a ComStar DropShip and left the system. It has been four weeks since then and there has not been a single sighting of the Coalition's leader. His military second, General Belle Lee, has been calling numerous planning sessions and the HPG on New Home is in near constant operation, yet there has been no indication that any of those HPG communications are coming from Stone.

Last week, INN freelance camera reporter Tad Silverstein blocked Lee's path in hopes of getting her to relent and speak to the press. Images of Lee feeding Silverstein pieces of his tri-vid camera have become a quick favorite on many intraweb sites. But still no word on where Stone has gone.

I can't help but draw similarities to FedSuns history and the mysterious disappearance of Clinton's Cutthroats. When the Suns needed them the most, they were spirited away. Has Stone been pulled from us in our hour of need? Was this part of his own plan? I am not one for sensationalism or worry, but the fact is as of right now, Devlin Stone is missing.



## EARLY 3078: SMAS

## CAPELLAN FRONT

## INVADERS AT HSIEN

—Live news feed, Palos Daily News (CNS Affiliate), 4 January 3078

*[The screech of man-made lightning rips through the air as a dark green Vindicator with white stripes stomps through the smoldering remains of a brown wooden shed. It stops, then takes aim at a distant Gurkha whose PPC is still awash in bright after-arcs. Adjusting for the Blakist's movement, the Vindie lets loose with its own electric-blue volley, tearing a huge gash in the bone-white 'Mech's torso. The blast rips off a huge chunk of armor, revealing blackened structural supports and a hint of engine shielding beneath.]*

*Nearby, an infantry team struggles to set up a support laser, feverishly pounding a half-meter stake into the ground to stabilize the laser's base. As they work, the Gurkha casually unleashes several streams of bright-green light from its quartet of small lasers. The screams of the dying are overpowering. The camera ducks as one of the streams pass overhead.]*

**[Kirkland Terhune]:** "...is an absolute slugfest! Not thirty minutes ago, the Fourth MAC made a push into the suburbs surrounding the Baling Fish Cannery, where the Word's Protectorate Militia has established a heavy defensive cordon. While both forces were fully engaged, the Fourth Tau Ceti Rangers made a brilliant, end-run maneuver around the Blakists' right flank and took them completely by surprise! The battle was over before the Blakists even knew...holy sh—get down!"

*[A withering hail of autocannon fire erupts from a copse of poplars behind the Vindicator. Depleted uranium slugs greedily chew into and through the medium 'Mech's left arm, throwing the appendage roughly to the ground where it crushes a nearby infantryman. Surprised, the Capellan turns just as its tormentor, a Perseus wearing the insignia and colors of the Twelfth Atrean Dragoons steps from the tree-line and fires a second burst into the Gurkha ripping into the already damaged engine shielding. A second Perseus follows closely behind the first. Meanwhile, Capellan infantrymen scramble to array themselves against the new threat. The support laser fires a shot into the second Perseus' head assembly with little effect.]*

**[Terhune]:** "That's—This is insane! The Twelfth Atreus is one of Alys Marik's rebels! These are Stone's Coalition! My friends, the forces of Alys Rousset-Marik have joined the fray against both House Liao and the Word of Blake. Why? That's anyone's guess, but we are now in the middle of a three-way shooting match and the Fourth MAC is seriously overextended. Unless the Fourth Tau Ceti Rangers are able to—Hey! Stop! I have authorization to..."

*[The camera jerks wildly as a soldier works to pull the camera from Kirkland's hands. A single shot rings out.]*

**[First Soldier]:** "How do you shut this damned thing off?"

**[Second Soldier]:** "Like this."

*[The ground rushes up to meet the lens.]*

## FREEDOM MANIFESTO

**[Derrick Ledbetter (voiceover)]:** "Michael Peterson is a student at Cella City Polytechnic and a leader in the protests currently sweeping through the university."

**[Michael Peterson]:** "We want the government to adopt the principles of the Kittery Manifesto, basically. The old power structures are finished; it's time for something new. Devlin Stone has shown us the way."

**[Ledbetter (voiceover)]:** "But when asked what this new something would be, Peterson was less certain."

**[Peterson]:** "That's a good question. Well, we want an end to rule by the noble class. And a more equal style of representation, that's a must. But, really, we just want change."

**[Ledbetter]:** "And what about the accusations that the demonstrators are rejecting their Capellan heritage?"

**[Peterson]:** "What? No, no, we're not rejecting our heritage at all. Listen, I'm proud to be a Capellan. But do I have to live under the Confederation to be a Capellan? Do I have to subject myself to a bloated and stagnant system because of the circumstances of my birth? No, we're not rejecting our Capellan heritage at all. Our goal is to bring a Capellan flavor to the post-war political landscape, to take what is unique and valuable about Capellan culture and add it to whatever comes next."

**[Ledbetter]:** "Do you fear for your safety at all because of your public role in these demonstrations?"

**[Peterson]:** "I'd be lying if I said no, wouldn't I? Yeah, I'm afraid. But only a little. I know that if I fall, there will be many more to take my place. This movement isn't about me or you or even Devlin Stone, really; it's about change and freedom and the future."

**[Ledbetter (voiceover)]:** "Two days later, Michael Peterson vanished from his apartment in the middle of the night. I can't help but wonder if my questioning him in public may have sealed his death warrant."

—Footage from *Stone's Soldiers*, a documentary by film student Derrick Ledbetter, March 3078

## PITY THE PROTESTORS

*And now for tonight's Special Comment:*

Amid reports of increased subversive activity on several Confederation worlds—including the mass arrests on Genoa two days ago—I find myself thinking about just what it means to be Capellan in this day and age. I grew up in the wake of the War of Davion Aggression, and I was instilled with a great pride in my nation—great pride and a profound respect for the leaders we have entrusted with our safety and our future. That's one reason why these so-called protestors get under my skin so much.

But I also find that I cannot truly *hate* these young people for their actions, even as I disagree vehemently with their rhetoric.

You see, many of these students—for the crowds at these events are predominantly made up of university students—have never really known life during peacetime. They were very young children when the Word of Blake launched their war across the

## DAVID LEAR: WAYWARD CITIZEN

(2 May 3078)

Sian [ISNS] — Many have wondered how Stone has been so successful in his endeavors. His Coalition has yet to face a crushing defeat, and when his new Coalition does falter, it is frequently despite his plans, not because of them. What makes this Devlin Stone so remarkable? Some say that his capabilities can be traced back to one of the Great Houses, often naming him an illegitimate offspring from a tryst by a House lord of loose moral fiber—usually Hanse Davion.

Such claims may be accurate, but neglect to regard one critical aspect: David Lear, son of Kai Allard-Liao and descendant of Maximilian Liao. Could it be that, despite an upbringing outside the Celestial realm, his Liao blood runs true? According to those in the know, Lear—not Stone—may be responsible for all major battle strategies Stone and his Coalition now employ.

Excellent works of such a nature make him highly eligible and desirable for Capellan citizenship by any standard. The Chancellor has stated on numerous occasions that it is the duty of every Capellan to resist and defeat Blakists through any means possible.

It is therefore not strange at all that many argue David Lear should be seen as a citizen of the realm. But others note that even as Lear's actions against the Blakists strengthen the Confederation, he has been unable to return any Capellan worlds back to their rightful realm, once stolen by Coalition troops. But is this deliberate or the evidence of a confused upbringing in the Federated Suns?

All of these are valid concerns, but one must also be aware that—through his actions, if not his words—Stone has proven himself a Davion puppet on many occasions. If he benefits from Lear's council, it is also clear that his taskmaster, Victor Davion, will never allow him to return Capellan worlds, no matter who he has to thank for them. It would be foolish, then, to hold such a crime against Lear.

So, the question is then before you, our readers: Is David Lear a wayward citizen of the Celestial Realm, or a traitor to his Capellan blood?

Inner Sphere, and they have grown up with the reality of war an ever-present part of their daily lives. So, who among us can really blame them for wanting the fighting to end?

Nor can I blame them for turning to this Devlin Stone character to help them achieve a lasting peace. He claims to offer a chance at peace, and I cannot blame them for jumping at it.

No, I do not blame them; I pity them. And I blame *us*.

These children do not know the glories the Chancellor offers his people. They have fallen prey to corrupting influences because we—their parents, their mentors, their teachers, their role models—have failed them. We have failed in our most basic

## SMASHING THE WALLS

responsibilities to our future. We have failed to teach our children and our grandchildren that the Celestial Wisdom offers the only true path to peace, the only true glory and harmony.

Shame on us.

—Special Comment by Alfredo Chen, Sian Nightly News, 13 March 3078

## LIBERTY IS OURS!

People of Liberty! Hear our words and know them to be the truth! For years now, we have been nothing more than a prize to be fought over by power crazed warlords with visions of grandeur! We have seen every breed of would-be ruler stake their claim to our homes and our future. We have endured madmen, been poisoned by the sweet promises of diplomats, and fended off the yoke of militant aggressors.

We have survived the ravages of the Chaos March. Even worse, we have survived the pariah that is the Word of Blake and their infamous “purging fires”. More than any other world in the Inner Sphere, we have battled and bled and died for our rights. When no one could be bothered to save us, who came to our aid?

The Capellans, that's who!

Forget what you have been told and remember what have seen with your own eyes! The Davions and Steiners have left us to the curs as they battled over foolish pride. The Free Worlds League has disintegrated under its own rotting antiquity. All of them turned a blind eye as the Word of Blake put us under their thumb.

Now that we have worked with the Capellans to free ourselves from this tyranny, Devlin Stone and his so-called “Alliance” have arrived to claim us as their own. Strike out against this hypocrisy! Deny these power-mongers yet another prize! Let us honor those who have suffered and fallen with us! Let us take our place among the people of the Capellan Confederation. Let empty words serve us no more! Now is the time, good people of Liberty, to seize our own future now and forever!

—Author unknown, *By Our Right and Blood*, publisher unknown, 17 April 3078

## OFFERS REBUFFED

The threat of the Word of Blake has been purged from Confederation grounds. All traitors to the state have been brought to trial and judged accordingly. Their fate has been decided upon and justice has been served.

His Celestial Wisdom, the Chancellor, thanks all of you—*janshi*, officers, and citizens alike—for your efforts and sacrifices in these trying times. He is proud to lead a people with such unwavering confidence in its abilities.

But still, the threat is not over. Not till the last enemy lies at our feet, breathing his final breath at the tip of our swords!

We, the Capellan people, have a sacred duty to support our brethren in the still-occupied territories. They have waited long



## EARLY 3078: SMASHING THE WALLS

enough as part of the Word's so-called Protectorate. It is their birthright to return home under the sheltering mantle of the Confederation. Protected from harm once and for all!

To this end, our Chancellor offered us—the CCAF—to Devlin Stone's assistance in a major Coalition operation to free Capellan worlds. Our strong arm and sharp blade would liberate Terra, heart of the Blakist terror.

However, we shall not strike yet. Stone—in his boundless arrogance—has rudely rejected the Chancellor's generous offer—obviously influenced by his puppet-master Victor Davion, whose personal grudge against the Confederation and its people are legend.

This is why the Chancellor asks of you one more great effort, one that might be harder to endure than everything else until now: He asks you to be patient.

Yes, he feels your eagerness to push on, to put an end to this war, as if it were his own. But this time has not yet come.

—Excerpted from "motivational packets" distributed to unit commanders in the CCAF, May 3078

**WHEN WILL THEY COME?**

(18 May 3078)

Sian [CBS] – Why does the Federated Suns devote so much time and energy to promoting Devlin Stone's personal agenda? What could this lackluster upstart from Kittery possibly offer to convince them to march to his personal drumbeat? What nefarious deal has Stone struck that could convince Yvonne Davion and her consort, Tancred Sandoval, to pull so many of their critical regiments from the border worlds near the Periphery and the Combine to use in their holy war against the Word of Blake?

Do they do it for the glory and honor of serving humanity? Or is it more likely for the offer of salvage and lostech that the greedy and resource-hungry Federated Suns simply could not refuse? Is this entire war, in fact, just a grand crusade for riches and land wrapped up in rhetoric and even grander political machinations? Of course it is!

In the entire history of the Federated Suns, House Davion has never joined in any political or military endeavor where they could not secure serious economic and strategic benefits for themselves. Why should now be any different?

In 3029, Hanse Davion used the distraction of his own marriage to Melissa Steiner as an excuse to launch the most egregious imperialistic expansion in recent recorded history, seeking to swallow up the Capellan Confederation in one fell swoop. Then, during the Clan Invasion, he managed to wrest serious economic and military concessions from the Free Worlds League by using the illness of the Captain-General's own son as leverage!

Are we to believe that his daughter Yvonne is any different? They did not call Hanse "the Fox" for nothing! What will we call Yvonne? "The Weasel"?

## STONE IS COMING

(28 June 3078)

Sian [SID] – Loyal citizens of Capella, beware! The tyrannical Devlin Stone and his puppet lapdog Victor Davion, the enslaver and oppressor of the Capellan people, have disappeared, together with the bulk of their front-line forces, for parts unknown. For months, intelligence sources have hinted that Stone was creating a secret army for some dark, sinister purpose. Now, missing from the rolls are Stone's Lament and the Com Guards' complete Second and Third Armies!

Both men were last seen on New Home, shortly after savagely punishing that peaceful world for daring to oppose their imperialist agenda. Hundreds of thousands were killed in a week-long symphony of destruction, orchestrated by Devlin Stone himself and his Kittery Alliance, in concert with their conniving allies, our long-time nemesis, the Federated Suns.

Ever since overthrowing the Kittery planetary government, Stone has worked feverishly to carve a grand empire for himself out of the ashes left behind by the Word of Blake. In his mad rush for power, he has continually set his sights on the Confederation. He has repeatedly prevented our forces from regaining territories stolen by the despotic Blakists, conquering many of them himself. Worse, he has refused all peaceful requests to return these ill-gotten worlds to the Confederation—going so far as to garrison them with Federated Suns troops!

Now that this usurper has a solid foothold on planets within but a few jumps of Sian, will he bring his secret army to the Forbidden City? Will he and Victor attempt to finish what the devil Hanse started fifty years ago, and attack the Celestial throne itself? If that is their plan then they had best come prepared for the bloodiest fight they have ever seen.

Stone, stay away from the Confederation or it will be your grave!

Mark these words, people! Once this Blakist threat is removed and the Suns' regiments return, flush with new tech and material, Princess Yvonne will refocus her eyes on the rich and unspoiled worlds of the Capellan Confederation! Will Stone then turn his back to her actions in thanks for a job well done?

If so, where will her regiments strike? Will they move against the St. Ives Commonality that recently fought so hard to retain its heritage in the face of Duke Hasek's ambitions? Or will they aim at the heart of the Confederation, and attempt to decapitate us by invading Sian directly? Wherever they choose to strike, we must not be complacent. House Davion and their allies can *never* be trusted!

**PLEIONE SECURED**

(15 June 3078)

Pleione [LNN] — Capellan citizens on Pleione have cause for celebration today. Warrior House Hiritsu has been dispatched to

## EARLY 3078: SMASHING THE WALLS



Pleione with the Harloc Raiders and Roman's Mounted Fusiliers, and it will now be but a matter of days before these master strategists discern the weaknesses on this key Protectorate world. Pleione has long suffered under the yoke of Word of Blake oppression, and it is only befitting that *Shiao-zhang* Ty Wu Non's brave warriors have been granted the honor to return the world to our dominion.

The fall of Pleione will create a substantial weakness in the Blakists' interstellar defenses, a weakness our brave warriors of the CCAF will eagerly exploit.

Meanwhile, all loyal Capellan citizens should prepare to welcome the return of this long lost world to the Celestial fold. The people of Pleione have suffered long under hardships of the jihadists' rule, and substantial investments will undoubtedly be required to ensure that they can once again enjoy the standard of living we have all grown accustomed to.

*Xin Sheng!*

## LEAGUE FRONT

### NEW YEAR, NEW WAVE

(5 February 3078)

Hsien [RESISTANCE DAILY] – The following comes from an Update News report from Nigel Holmgren, an embedded with Alys Rousset-Marik's Task Force, transmitted through INN's news outlet:

Duchess Rousset-Marik's League Thrust task forces continue to advance deeper into its assigned corridor, meeting various levels of resistance. For security reasons, I can report only loose details about the force structure and actions of the multi-planet assault at this time.

On 3 January, the task forces initiated a simultaneous assault on Chertan, Dubhe, Asuncion, Eglin, and Hsien.

On Chertan, ComStar's Fourth Army reportedly made contact with both Chertan PM Divisions almost immediately upon landing. The Chertan defenders fought tenaciously, nearly forcing the Fourth Army off world, but the experience and skill of the Com Guard command ultimately prevailed. Forced into an untenable position, Chertan Protectorate Militia surrendered, clearing the way for the allied occupation.

On Dubhe, both local Protectorate Militia Divisions defended the world against Clan Nova Cat's Alpha Galaxy and the Twentieth Marik. The combined strength of the Marik and Nova Cat forces proved too much for the Blakists and they quickly folded, retreating from Dubhe in fairly short order.

Asuncion proved to be less difficult than any of the planners alleged it would be. When Group IV landed, the resistance they met was completely disorganized. Although these defenders still put up a fight, the battle lasted for a week before Asuncion capitulated.

## MISSING: PHOTON BRETT-MARIK



And still Tamarind hasn't shown. Did Photon set his calendar to the wrong year? Perhaps he got lost. Maybe his luggage is held up in customs?

Another possibility might be that he's decided to go back on his valiant commitment to support Alys Rousset-Marik and Devlin Stone. Yeah, it's a really remote possibility given the probability of the luggage scenario, but we must be thorough in our analysis.

After all, Tamarind has been "securing its borders" as well as "establishing a buffer zone with hostile entities" and let's not forget that they had to "engage hostile forces participating in piracy and brigandry." I kid you not, "brigandry" is apparently a word in the Tamarind Duchy. I didn't know.

Oh, and let's not forget the noisy neighbors. Yes, the frothy scum of the "Buena Archonette" have been up to all kinds of shenanigans, some of which could be described as "brigandry", perhaps, if you happen to be about a jump from Millungera. Speaking of imaginary words, I have to tell you, the first time I heard "Buena Archonette" I thought someone was talking about the latest porn star. But I digress.

Whatever the reason, I hope Alys wasn't banking too hard at having cousin Photon to lean on or hide behind, because he ain't comin'. I reckon she'll have enough bullet sponges around to make do (nobles always do), but the lesson for the rest of us is: Marshall Photon Brett-Marik's word isn't worth the paper it's printed on. Tell him that if you happen to see him in the lost and found.

—Anonymous OpEd posted on the Augustine Press interweb site, 2 May 3078

In contrast, Group II faced heavy resistance on Eglin. Eglin's PM Division defended the planet fiercely and made the allies' effort to liberate the world extremely difficult. Yet even though Alys' forces suffered moderate casualties, the militia ultimately surrendered after the loss of its commander.

From the start of the operation, the battle for Hsien quickly devolved into a quagmire. Hsien's defenders consisted of the Hsien's Hotheads and the Hsien PM Division. The Allies—consisting of the Twelfth Atrean Dragoons, Seventh Donegal Guards, Clan Hell's Horse's Eleventh MCAV, and the mercenary Devil's Brigade—began to push the defenders back despite fighting that began at roughly equal numbers. However, when the Capellan Confederation's Fourth McCarron's Armored Cavalry and Fourth Tau Ceti Rangers grounded, chaos erupted. The CCAF forces engaged both Blakist and Coalition groups simultaneously. The Coalition commander ultimately convinced the Capellans to



**EARLY 3078: SMASHING THE WALLS**

join the allies against the Blakists, however, and together they were able to overpower the enemy after another week of heavy fighting. But when the beaten defenders attempted to surrender, the CCAF forces allegedly ignored the request and pressed their attack. When the Coalition commander attempted to intervene, the Capellans once again turned on the allies and were ultimately forced to withdraw. The exhausted allied forces finally secured the world and prisoners, but with casualties as high as fifty percent across the board.

Now, following a month of heavy engagements, the League Thrust is standing down for rest and resupply, preparing for the final push to Terra.

**THE PUSH CONTINUES**

(3 May 3078)

Molokai [RFP] – With the riots now into their second day, the warm welcome the Sixth Hussars expected after liberating Molokai has clearly not materialized. Even though the on-world FWLM forces surrendered peacefully and allowed the Hussars to assume their vacated barracks, the Molokai populace has made it clear that the Regular “liberators” are not welcome here.

The situation mirrors that on nearby Clipperton, where the Seventh and Eighth Regular Hussars were forced to deploy infantry in riot gear after locals set up a burning barricade outside their barracks. Clearly, the RDF units were expecting a reaction similar to that experienced in the Regular Free State, whose peoples eagerly embraced their liberators from Word of Blake oppression. But these initial hostilities should come as no surprise, especially after the Word of Blake’s broadcast of the Hussars’ nuclear assaults on Futuna, Newcastle and Norfolk in the previous year.

Having let the WMD genie out of the bottle, it seems that Regulus’ troops are now tarnished with the same reputation as the Blakist jihadists they oppose. Even though the weapons used were tactical in nature, and only directed against military targets, Word of Blake propaganda has whipped up a frenzy of mistrust and fear. Even the peaceful departure of on-world FWLM forces has not assuaged the locals’ fears of an imminent nuclear assault.

But most troubling for the Hussars—and for any hope of continual peace—are the rumors of abductions and grisly murders being carried out by Word of Blake ROM units still hidden on Molokai. Unable to prove these abductions as the work of Blakists, and surrounded by a hostile and untrusting populace which defies all dialog, tensions can only mount against the Regular troops. Although Colonel Lord Downes of the Sixth has yet to deploy his ‘Mechs on anti-riot duty, pundits are saying it is only a matter of time.

**BETHANY BARRETT: ORIENTE HERO**

Ever since her single-handed capture of the Blake Protectorate world of Hall, Bethany Barrett has been a popular

**RESCUE GONE AWRY**

(17 March 3078)

Goth Khakar [GKT] — While all official sources continue to deny it vehemently, every indication is that a mission sent to “escort” the delegation to Niops back to Free Worlds League space has gone awry.

Not two years ago, word reached us that efforts to lay permanent contact and a potential trade relationship with the Niops Association were succeeding. The Association apparently suffered a series of recent political upheavals that challenged its independence and self-sufficiency.

More recent reports, however, paint a far more serious picture. A full-blown civil war is said to have erupted sometime between July and September of last year. Rather than a short war, this conflict has raged on, and preparations were made to send a mission to extract the League’s delegation amid great secrecy. Based out of Romita, a team was dispatched to bring the delegates home before the situation on Niops worsened further.

While the exact departure date for this rescue mission and the exact composition of its forces remain unknown, one thing has become clear: they have had plenty of time to extract the delegates and return to League space.

This has led several to wonder whether the Niops Association’s military capabilities have previously been underestimated. One high-end estimate of the mission to Niops suggested a full BattleMech regiment plus supporting forces, though it’s more likely that no more than a battalion was sent. If Niops had the ability to impede such a force, it would be very troubling should they switch from an isolationist to an expansionist policy. Fortunately the frogs and flies next door will make a more appealing target—at least initially.

Perhaps more plausible and worrisome is the probability that another external force has taken control of Niops with a force adequate for taking on the rescue mission as well. Someone like the Marians, perhaps.

Whichever option is true, the situation requires additional scrutiny and vigilance—plus a greater degree of information shared by our government officials. They know more, but haven’t been pressured adequately to release all pertinent information. Do your part to find out what’s going on over there by signing our petition, details in this [link](#).

figure in Devlin Stone’s new army, and now with her promotion to command the newly-formed fourth battalion of Stone’s Lament, it appears that her star is still on the rise. A charismatic woman, she has given the populace of Oriente someone to be proud of in these troubled times.

Whilst her diplomatic exploits on Hall are well known, what is lesser known about this woman is her tireless efforts to fight the Word of Blake. A close confidant of Stone’s would-be mentor David Lear, Barrett has again and again demonstrated

## EARLY 3078: SMAS

her commitment to the cause, culminating in her recent actions to save the life of Devlin Stone himself. In this exclusive report, we will detail how Barrett, who was born on Loeches, but grew up on Oriente, managed to foil an assassination attempt at the leader of the Coalition.

But not everyone is happy with Barrett's meteoric rise through the ranks. Despite professing admiration for Stone's merit-based system, General Belle Lee has not made any secret of her dislike for "the new girl on the block". Several commentators have put this down from everything from petty jealousy, to the traditional disdain MechWarriors like Lee feel towards infantrymen like Barrett. Others have made mention this is first time a promotion has come from Stone himself—through the auspices of Lear—instead of Lee herself.

But regardless of her disapproval, even General Lee cannot deny the bravery and courage that Barrett and her unit demonstrated when engaging and defeating a pair of Manei Domini assassins intent on ending the life of Devlin Stone himself. This is that story...

—Excerpt from *Special Report: Heroes of Oriente*, Oriente Observer vidzine, 10 May 3078

**TERRA'S DOORSTEP**

(20 June 3078)

Pollux [FWAP] —The offensive has paused. On the Free Worlds front no new attacks have been launched since the beginning of April. On Liberty, Group II is still staring across the field at CCAF forces and awaiting an impartial mediator to settle their stalemate, but the rest of the League Thrust forces have gathered here on Pollux, preparing for the last push to Terra. As I watch yet another cheering parade of Polluxians celebrating the end of their Blakist occupation, I look back on the past eighteen months and cast a critical eye at the readiness of these forces to face what is sure to be a brutal campaign for humanity's home.

Suffering a rough start to her offensive, Alys's Roussett-Marik's advance has been both plagued by unspeakably poor luck at one turn and outrageously strong runs of luck at the next. With roughly twenty worlds in her theater of operations—close to half as many as the Federated Suns thrust—nearly half those worlds were liberated with barely a shot fired. Countering such good luck were several tragic or destructive setbacks, from an aircraft laden with fuel-air explosives crippling a vital Nova Cat supply ship on Graham, to a successful Blakist counterassault on Marcus. The bloody fighting on the League

**NUKES ON NIOPS**

(17 May 3078)

Lesnovo [RNN] — The Rim Commonality was shocked today when the latest news from neighboring Niops arrived. While rumors of the small nation undergoing a civil war were rampant, few realized the scope of the conflict. While the reports are unclear about many things at this time, one thing is certain: a nuclear weapon was detonated on Niops VII. The resulting explosion killed Brigadier Fallon and Chairperson Olsen, leaving the Niops Association effectively leaderless at this time. Rumors of additional nuclear strikes have also reached us here in the Rim, as well as talk of unknown invaders.

At this time, it would be easy to speculate that the nuclear weapon(s), invasion, and possibly even the civil unrest are all due to the Word of Blake or their agents. (Some might even say that's all probably true.) However, while the Word has shown itself capable of anything, let us not forget that the Marian Hegemony has a similar history of barbarism. While their recent period of transitioning away from pirate state and expanding despotism toward enlightened empire has thawed relations, they are less than a generation removed from rampant attacks upon our worlds, still legalize slavery, and have made more than a few encroachments against the League's borders. While publicly licking their wounds from their latest Circinus spat, they might use the Inner Sphere's chaos to conquer again.

There's also the classic possibility: With the recent bloodshed across Niops, another small-time Periphery warlord could be trying to take over the weakened Association. A minor pirate power, or even a disaffected military commander in the vein of old Hendrik Grimm or Redjack Ryan might be behind this recent act of genocide. All we do know is that our hearts and prayers go out to the poor citizens of Niops. We urge the Rim Commonality to marshal forces to protect these people in their hour of need and bring much needed aid and supplies.

side of the offensive has left this task force battered and demoralized. Group IV is all but shattered, with the Exiled Wolves' Beta Galaxy the strongest of the three commands at little more than a Cluster's size.

Given how the League Thrust has fared in the face of stiff resistance, will their resolve hold in what is sure to be fighting unlike any we have seen in centuries? Will Duchess Roussett-Marik be able to hold her commands together with the force of her indomitable will, or will attrition and fatigue finally win over? For the sake of all free men, we can only hope strength prevails.



## EARLY 3078: SMASHING THE WALLS

**AND IN  
OTHER NEWS...****THREAT LEVEL HIGH**

(27 December 3077 – Repeated through 9 April 3078)

New Samarkand [DRAKE] – **The following is an Emergency Travel Advisory!** The Voice of the Dragon has received an alert from its ISF Information Liaisons of the current situation in the Qandahar Prefecture that has them warning all civilian and commercial traffic to stay clear of the area. Although they are light on the details in the official dispatches, the Drake has learned a lot about the nature and extent of the problem, and for once we're with the Dragon on advising everyone to stay clear.

The short version is that there is an outright coup in progress throughout the Prefecture, launched by the outlaw *Kokuryu-kai* (A.K.A. "Black Dragon Society"). The Combine government is declaring their travel restrictions are now in effect to bar any non-military/non-government traffic from entering the Qandahar Prefecture and/or landing on the following worlds: Qandahar, Slaithwaite, Kamarod, Nowhere, Korramabad, Pusht-i-rud and Ad Duwayd. This is because each of these worlds is currently occupied or compromised by the outlaw forces. On Slaithwaite, the planetary government itself is openly supporting the Black Dragons with all the resources at its disposal.

Reportedly, the situation on Korramabad is fast becoming a nightmare for the citizens, specifically the two million or so Azami citizens inhabiting the continent of Herkilon. According to reports from reliable sources within the prefecture, the Black Dragons issued an edict stating the all Azami citizenships are revoked and ordered them all to leave the system by the end of the month. There is an implied threat, but to what end, no one is sure. However, knowing the treachery and bloodlust the Black Dragons are capable of, it does not take much imagination what will happen. [Ed— *On 31 December, BDS forces summarily executed several thousand or more of those Azami, and publicized the event for all to see.*]

The other worlds covered by this advisory have experienced similar upheavals as Qandahar and Korramabad, to greater or lesser degree. Reportedly, many key depots, infrastructure command centers, and military installations are now controlled by the Black Dragons. Surprisingly, many citizens on these planets are supportive of these insurrectionists. Unfortunately, with the current war against the Blakist regime, DCMS forces are not available to deal with the current situation. The lack of government troops or support has seemingly inspired and emboldened the Society. We will not know the full extent of this illegal uprising and treason until such time DCMS forces are available to act in

the defense of the Draconis Combine. Until such time, do not travel to the Qandahar Prefecture.

[Ed— *Reliable reports say the DCMS mobilized at least one line regiment to deal with the situation on Korramabad some time in late March.*]

**TRANSFER OF COMMAND**

(2 January 3078)

Regulus [RNS] – In a surprising move, Prince Titus Cameron-Jones today handed official command of the Regular Defense Force to General Thomas Orfelt. Orfelt has technically been in charge of the RDF since December of last year, but until now it was presumed that Prince Titus would maintain the honorific title of the RDF's Commanding General, if not the actual responsibilities. Orfelt is also the architect of the current actions against the Marik Commonwealth, and it is argued he was the one who made the controversial decision to use tactical nuclear weapons against Commonwealth strongholds to hasten the conflict.

The move does bring to question Prince Titus' motivations, and indeed his state of mind. With the untimely death of his father, plus the horrific loss of his wife and unborn child, observers are questioning whether the Prince has succumbed to the grief that has been plaguing him, and is withdrawing from his martial duties to spend more time with his surviving son, Lester. Other commentators suggest that the loss of Princess Michelle sent reverberations through the RDF.

Despite her regal duties, Princess Michelle also acted as Prince Titus' adjutant, with nearly every military decision going through her. This situation—reportedly tolerated by the RDF High Command because of the Princess' aptitude in military matters—left Prince Titus adrift after her death. According to some sources, the Prince even consulted his estranged father for military advice as a result.

Whatever the reason, Prince Titus' withdrawal from the public eye has been accompanied by whispers questioning his ability to lead the nation through these troubling times. With Regular forces engaged in combat on multiple fronts, the people need a strong leader. But while General Orfelt is that for the RDF, he does not lead the nation. Only time will tell if Prince Titus has the strength of character and conviction to continue to make the hard choices.

**DIPLOMACY, PLEASE!**

Archon Steiner,

I admit that it must sound in no small part hypocritical of me to be writing this. The nation I once called home is a shattered hulk and I have chosen to take charge of what small area I can. But I did not do that out of malice, thirst for power, or some other selfish goal. The Duchy of Tamarind does not seek conflict with her neighbors, nor are we in any way connected to the Word-controlled government of Atreus.

## EARLY 3078: SMASHING THE WALLS



Unfortunately, it appears as though some in your nation have come to see my people and I as a viable target, a meal of planets to be gobbled up at the buffet line.

I urge you to intervene in this gathering storm. Like your nation, my own Duchy has stepped up to stand shoulder to shoulder with Devlin Stone. We acknowledge the common enemy that is the Word of Blake. What few forces we have are spread desperately thin in response to dangerous raids from the Periphery and instability from within the shattered Free Worlds. We are no threat to your nation and, in fact, can likely offer little in resistance to the threats stemming from your Buena Archonette.

In the name of peace, and our mutual commitment to end the greater threat of the Word of Blake, I implore you to intervene before more blood is wasted in vanity's name.

—Letter from Duchess Therese Brett-Marik to Archon Adam Steiner, Free Worlds Associated Press, 15 Jan 3078

**CHARGES FILED**

(30 April 3078)

Kittery [ISNS] — *[A powerful man is at a podium, an assembly of microphones like some metallic shrub. His unremarkable suit looks like it is about to explode at the seams while his dark features are washed out by a multitude of lights.]*

**[Voice (ID: Marcel Webb)]:** “Thank you all for coming. I have a series of announcements, so please save the questions until the end. The first thing I’d like to tell you, is that through agents at the scene, we have arrested Giovanni Estrella De la Sangre, former CEO of Vicore Industries and illegally appointed President of Demeter. He was captured a year ago—”

*[Loud murmuring begins. Someone begins to shout a question.]*

**[Webb]:** “People, please! Questions at the end. As I was saying, we’ve been questioning him since his capture, and he has provided us with much useful data. A lot of lives have been saved, but keeping his arrest secret has exceeded its use at this point. The Coalition has filed charges against De la Sangre on behalf of all nations in the allied Coalition and its peoples. The charges include conspiracy to commit genocide, illegal sale of restricted weapons, treason, and violation of the public trust. He will be tried after the conclusion of the current military campaigns, at a location to be determined. The format will also be determined at a later date, but he will receive counsel.”

*[Webb takes a brief pause and shifts on the podium]*

**[Webb]:** “In addition, the Coalition is filing charges against additional parties in the Word of Blake high command. Charges of genocide, murder, and terrorism are all being filed against Cameron St. Jamais, the individual known as ‘Apollyon’, Alexander Kernoff, Gregory Zwick, and the individual referred to as ‘the Master’. Two other known Blakist operatives, Mary Durant and Benjamin Emory, will be charged with genocide, murder, terrorism, espionage and treason. Parker Steele, head of the Voice of Blake has only been charged with conspiracy at this time.

Additional charges will be brought against other members of the Blakist organization as further evidence is uncovered.

“Thank you for your attention. Now, I can answer a few questions.”

**[Voice (ID: Doris Coone, INN)]:** “Will these be civilian trials or military tribunals?”

**[Webb]:** “Unknown at this time. That will be decided later, as I said.”

**[Voice (ID: Jeffery Fiscus, VOTD)]:** “Will they be presumed innocent until proven guilty?”

**[Webb]:** “Likely, yes, but not for certain. Last question.”

**[Voice (ID: Kiva Cooper, SBC)]:** “Why are you waiting to try De la Sangre? You have him now.”

**[Webb]:** “We want to finish the war first, then focus on recrimination, when all the facts can be brought to light. Thank you.”

**THE TRUTH ON NEW HOME**

—Anonymous message to ISAP, found in an HPG packet received from New Home, 18 May 3078

As I write this, my door is barred, the windows are covered and my trivid is disassembled. Why you ask? Because I know the *truth!*

Stone and his followers didn’t just kill hundreds of Blakist fanatics during their “Week of Death” on New Home, they also murdered hundreds of thousands of innocent men, women and children! It’s true!

See here’s the thing, Stone brought in his whole Group I and Group II armies looking to take out the Third Sirian Lancers and one of them fancy WoB Divisions called the Forty-third Shadow. He brought the whole armory and they arrived with a serious mind for mischief. But old Blake wasn’t playing. They spent weeks biding their time, just toying with the Coalition. Oh, they defended themselves and did some damage too, but they wouldn’t fight Stone or his Lament straight-up, like he wanted. So Stone got real mad. He told his general, this Belle Lee lovely, to “go wild”. She tore the place up trying to get at them, but the Forty-third was just stringing Stone along until the main event.

Two more Blakist Divisions showed up and crashed the party.

So crafty Stone took up residence in this old Star League fortress and lured them in for a good old-fashioned siege. Then, after a week of this, he had one of his orbiting WarShips blast them to smithereens with brutal naval fire that would make the Smoke Jaguars proud!

As the Blakists began dusting themselves off, out came the hero Stone after them. In a twenty-four hour orgy of house-to-house extermination Stone blasted them all to hell leaving the city around that fortress a heap of smoldering ruins.

Then he was all, “Sorry about your planet. We’re here to help”.

If this Stone’s idea of “liberation” then we’d better pack our bags, before they come “help” us too.



## PROFILES: LIN MURIKAMI

**Name:** Lin Murikami  
**Born:** 3045 (32 in 3077)  
**Position:** Diplomat

Unlike many of her colleagues within Stone's Coalition, Murikami's past is relatively straightforward and unassuming. Born on Togura to a DCMS *chu-sa* and a local peasant woman, Murikami was immediately put up for adoption by parents unable to care for her. She languished in an orphanage for several years. When the Murikami family adopted her in 3052, she was unable to read and could barely communicate. Her new parents assumed she was a child of special needs.

All the young Murikami needed, however, was a loving and nurturing home. Released from the oppressive environment she grew up in, Murikami blossomed into a very intelligent and capable young woman. At the age of 17, she was accepted into the prestigious New Samarkand Universal School of Law, graduating in an unprecedented two years at the top of her class and with full honors. She was offered the rare opportunity to head the law department at the Prefecture's Ministry of Communications, where she remained until her disappearance in 3067.

Written off as a victim of violent crime after a cursory investigation of two months—something not uncommon on the streets of New Samarkand, unfortunately—no one thought anything further of the bright, intelligent and diminutive lawyer. Her adoptive parents had died two years prior, and the young woman was a social recluse, known more for her long hours and sharp, analytical mind.

Her appearance in a New Avalon POW camp liberated by guerilla forces in 3072 came as a complete shock to the few bureaucrats who remembered her. How she had gotten captured by the Word of Blake on the capital of the Combine's ancient enemy still remains a mystery. Had she defected to the Suns when no one was looking? Murikami still refuses to answer questions about this, both on and off the record.

Murikami is often seen working on Devlin Stone's staff, usually behind the scenes. Most diplomatic requests are routed through her, and she apparently has the authority to speak on Stone's behalf, even to various Heads of State. She is a master of compromise and diplomacy, often handling matters of delicate political nature for Stone and David Lear. It is clear that in order to win political battles within the growing Coalition, one needs to cultivate the favor—and avoid the sharp rebuke—of Diplomat Lin Murikami.

## PREPARATION OR WITHDRAWAL?

(2 June 3078)

Regulus [HUSSARS HOWLER] – What the hell is the Prince doing? It's a question being asked by more than a few within the RDF, and we here at the Howler are all about looking after our boys and girls in orange. General Orfelt is a good guy, but he still has to follow orders, and the orders are being given by the

## DISHONOR AND DISCORD

There's just no way that this is legitimate. But it's also far too juicy to pass up. Someone either has an insane amount of access, or an excellent sense of humor. Either way, I'm happy!

<>

My Khan,

It is as we feared and worse! The entire event was sickening. To be in the presence of the traitor "Khans", and to have terms dictated to us by some random Spheroid freebirth... It is unbecoming! The Jade Falcon takes as it pleases, and answers to no one!

I urge you in the strongest possible words: do not agree to his "request" that no Clan troops may set foot on blessed Terra! I realize that the agreement is only binding while the Coalition remains intact, but it should be Jade Falcon Warriors who remove the stain of the Blakists from our holy homeworld!

To wait this long, to beg and plead for our allegiance, all the while knowing he would deny us our rightful part in the final battle... It took all I had to not challenge him then and there.

His affront is made more severe by graciously "allowing" us the participation of as many aerospace assets as we please in other parts of the Terran operation.

This man's insults know no bounds. It would be one matter if he was as ignorant as the average Spheroid scum, but he has proven an understanding of our ways that remove any reason for tolerance.

What's worse is that his stated reasons—even if accurate—do not remove another problem. Our Touman will not be placated by the notion that the Inner Sphere requires a "symbolic victory" by reclaiming Terra with Spheroid troops only. They will not tolerate the ridiculous concern that Clan troops on Terra will trigger infighting as it somehow forces us to determine who has become the ilClan. The Founder's will is quite clear on that point: merely setting foot on Terra is not the sign of an ilClan: to take Possession is what will be the distinction, and Stone has previously disputed our sovereign claims to *isorla* on Rigil Kentarus and other worlds. A dispute to which we have already relented.

I predict a severe impact on morale.

His final words were most galling of all. I paraphrase:

"This began as an Inner Sphere war, and it must end as one."

Indeed... Does he seek to turn our own words against us? Are we to look upon him as a respected equal, or as a Mongoose? Is this final assault not made possible by the struggle of the Clans in the interval? It certainly seems at odds with his prior remarks in our presence, *quiaff*?

My Khan, do not allow him to dishonor us now!

—Brian Pryde

<>

—Interweb post by "Starling", found on the Voice of Odessa net site, Gibbs, 31 May 3078

## EARLY 3078: SMASHING THE WALLS



Prince. Not that the Prince is a softcock—no sir. How many of you cheered when we started nuking those Blakist bastards last year? Give them some of their own back, we say!

But since then, what's happened? The Free States are pacified, and only just now has the tip of the spear been freed from what amounts to garrison duty. The First, Second and Fourth will need rest and refit, but we can't wait until Rolling Thunder and the Green Monsters go up against the Blakies for some serious payback! Even the household units drafted into service—the laughably named Sixth, Seventh and Eighth Hussars—are fighting more civilians than they are Marik bastards. We even have units like the Tenth, Eleventh and Fourteenth Hussars being given orders to let Marik and Blake units withdraw rather than chase the bastards down!

So is this part of some grand plan? We don't know—it's no secret that the Baghra Ghat has seen a massive increase in merc officers lately, but we've got a bunch of units that need R&R, so they're probably going nowhere. And we still have the big elephant in the room, the dagger poised to strike at our heart: Gibson. No one wants a repeat of last time, but we as a people need to see this blight taken care of. Of course finding units willing to go to that hellhole has to be a real challenge nowadays.

But Prince Kirc would have sorted it. Let's see if Titus has the balls.



## NOTHING CHANGES



I got this from a source swearing up and down it's from David Lear. Really? You know the Word's probably been investing a billion or twenty in reading the guy's mail, and he just comes across a particularly juicy bit?

Aww, who cares, enjoy!

<>

Devlin,

I apologize. Even I underestimated their pettiness. And I have precious few excuses for the oversight.

Talk about counting your chickens before they roost. I was expecting this kind of nonsense after we tear down the last Blakist banner on Terra, not prior. It sure is easy to see why ComStar's managed to recruit so successfully on a platform of simply *not* being a House.

But enough of my whining. On with the analysis.

I think we're out of the woods with the Clans. We both knew they'd have some serious problems with getting blocked out of landing on Terra, but obviously, we needed the political capital even more than I expected. Interestingly enough, it seems like the Nova Cats have the biggest problem with this all. Vlad will no doubt get all pragmatic with us before long, and I think even the Falcons will get over it. I was surprised by the Bears; I guess this means they're calming down a little bit—that or their Touman is more gutted than we thought.

Unfortunately, the side effect of this is that we've emboldened our Inner Sphere allies. Knowing that we can't backfill them with Clan troops if they pull out, they're already starting to use that leverage on us to one-

up each other concerning their relative prominence in the assault.

Their objective is two-fold. All of them will want to be able to have a legitimate claim as the "Blake slayers" in their homeland, so rear echelon stuff is out the window for pretty much all of them. I don't mean to pat myself on the back, but splitting the forces of each nation across all of the fronts has succeeded in ensuring none of them are in particularly better shape, so we have plenty of tangible evidence to prevent any particular faction from being "too prominent". If we stick you and Belle on the assaults that have a particularly strong ratio for one of our allies, I think we can further neutralize things. Similar juggling of commanders may be needed. Bit hard to hoist your banner when "foreigners" outnumber your own troops two-to-one. Ye olde "keep your friends close, and your enemies closer".

I'm not particularly worried about the noises for First Lordship. The above plan will take care of legitimacy at least to a point where no one can make an overwhelming claim. At worst, we'd look at the premise of another Succession War, and after all this, the first one to start it up would probably be flayed by his own nationals.

I'm not concerned beyond that. The good thing about egotists like these is that they're more concerned about their "equals" than us "common folk". Not the first time blueblood arrogance has come in handy.

—David

<>

—Interweb post by "Starling", found on the Who Knows? net site, Kimball II, 30 June 3078



## CHAOS ETERNAL: TRICK OR TRAP

## TRICK OR TRAP

*"And I told those boys the line I told hundreds before them, knowing just how bad it could get. Knowing just how much of a line of crap it was and how I would probably never see many of them again after this fight. And almost none of them by the time this war was over.*

*Just like their families wouldn't.*

*I told them to do exactly what I tell them and they would live through this."*

—Journal Entry J78-93A

## SITUATION

*Terra Firma, Word of Blake Protectorate*

*11 February 3078*

Terra Firma was supposed to be one of the easier ones. The populace was fed up with the Robes, and you had Stone at the head of an elite force, banging on the system door. Your job was to protect the flanks, but in the final stages, urban fighting became so brutal you were pulled in to reinforce the Ryuken-roku as they tried to take out the Blakist command unit inside the capital.

And then just as you thought fighting block by block was bad enough, buildings all around you suddenly started to explode into massive fireballs.

## CHAOS ETERNAL: TRICK OR TRAP

## GAME SETUP

This is a ground battle, using a mix of Light and Heavy Urban Terrain mapsheets (see p. 263, TW).

## Attacker

The Attacker consists of up to 75 percent of the player's total available force. In addition, the player's unit is accompanied by elements of Ryuken-roku of Elite quality not exceeding 30 percent of the player's deployed force.

## Defender

The Defender is 100 percent of the Attacking force, consisting of the Terra Firma Protectorate Militia and is of Regular quality.

The Defenders set up on the furthest map edge away from the Attacker's home edge. Defenders also secretly designate a building that houses their Commander.

## WARCHEST

**Track Cost:** 700 WP

## OPTIONAL BONUSES:

**+100 Surprise after Surprise:** The Defender may deploy up to half their units using the Hidden Units rules (see p. 259, TW).

**+200 Wind Tunnel:** Use the Strong Gale rules (see p. 61, TO).

## OBJECTIVES

**1. Root Them Out.** Two-thirds or more of the Defenders are Destroyed or Crippled. **(Reward: +500 WP)**

**2. Eliminate the Commander.** Destroy the building housing the Commander. **(Reward: +200 WP)**

## SPECIAL RULES

The following rules are in effect for this track:

## Booby Traps

Before the start of the game, the Defender selects six buildings at least 6 hexes away from any map edge to be booby-trapped. Calculate the explosive power by using the building's current CF divided by 5 (rounding up) at the beginning of the turn. The Defender may elect to set off the booby trap as long as a non-crippled or destroyed unit has LOS and neither the unit or the building is under the effects of enemy ECM.

A booby trap may be set off accidentally every turn it receives damage. During the End phase of a turn the building received damage, roll 2d6+ the total CF lost in that turn. If it exceeds the building's CF divided by 10, the booby trap is inadvertently set off.

## Commander Benefits

As long as the Commander's building is intact, the Defenders gain a +2 Initiative Bonus and ignore any penalties for spotting for indirect fire.

The Commander's location may be revealed by an attacking unit ending its movement within the designated building's hex, or any hex adjacent to it, or by end of the Movement phase with the designated building within range of the detecting unit's active probe.

## AFTERMATH

After the first two buildings exploded, crippling several of your men, your advance slowed considerably as every structure was now a possible firetrap.

## CHAOS ETERNAL: TRICK OR TRAP



It might not have been particularly brave, but letting the Ryuken-roku push forward ahead of you was probably the most prudent. You don't get paid to get killed, you get paid to win.

there might not be more out there; the provisional government may just have a side job for you. And are those Terra Firmans actually on your side, or is it a Blakist ruse?

**ADDITIONAL HOOKS**

Just because some buildings exploded doesn't mean that

**NEXT TRACK**

*Sticky Situation*

## CHAOS ETERNAL: STICKY SITUATION

**STICKY SITUATION**

**[Voice (ID: Michael Drummond, Star Commander):** "Optimal range in forty-five seconds, Star Admiral."

*[Shudder and static]*

**[Voice (ID: Jeremiah, Star Commander):** *[yelling]* "Taking more fire from the *Lioness!* Decks ten through fifteen venting atmosphere! Maneuvering thrusters six and twelve are gone, if we—"

**[Voice (ID: Star Admiral Alice Lenardon):** "Ignore it! Focus on getting a proper fire resolution on the core of the Blakists position. We have no more time to waste."

**[Drummond]:** "Thirty seconds to effective range."

**[Lenardon]:** "Fire once when we reach optimal range, Michael."

**[Drummond]:** "Ten Seconds...Nine...Eigh—"

*[Sounds of explosions and sparks]*

**[Jeremiah]:** "We lost a power module on deck two! Losing power and targeting to forward weapons! Great Father!"

**[Lenardon]:** "No time! Drummond, fire on that Blakist position *now!*"

—Excerpt from the logs of the NCS *Promise*, dated 26 April 3078

**SITUATION**

*New Home, Word of Blake Protectorate*

*26 April 3078*

This was bad.

Real bad.

It was a trap from the start. The Blakists played a delaying action perfectly until a pair of divisions jumped so close to New Home you swore you saw their JumpShips wink into existence. The past week was a victory just to survive, stuck in the ruins of an old SLDF base, until some brave souls broke away from the orbital fighting to land a perfectly aimed blow shattering the Blakist position.

Stone decided at that point to link up with one of his other regiments instead of being whittled down day by day. Knowing that staying where you were was a death sentence, you pushed forward into the breach with him.

## CHAOS ETERNAL: STICKY SITUATION

**GAME SETUP**

This is a ground battle using a mix of Light Urban Terrain mapsheets (see p. 263, *TW*). Place medium and heavy buildings of varying heights on every clear non-paved hex. Before either side deploys, roll 2d6 for each structure. On a result of 6-8, halve the structure's starting CF. On a result of 9-12, the structure is considered destroyed; the hex is considered Rubble.

The Defender designates one of the shorter map edges as the Attacker's home edge.

**Attacker**

The Attacker consists of up to 75 percent of the player's total available force. In addition, the player's unit is accompanied by a mix of elements of Stone's Lament. These units are Elite and may not exceed 100 percent of the player's deployed force. Openly designate one heavy or assault unit as the Attacker's Commander.

The Attacker enters the battlefield on the edge opposite their designated home edge.





## CHAOS ETERNAL: STICKY SITUATION

### Defender

The Defender is 100 percent of the Attacker's deployed force, consisting of the Forty-fifth and Forty-seventh Shadow Divisions. They are of Veteran and Elite skills, respectively.

The Defenders set up half of their force on the battlefield within ten hexes of the Attacker's designated home edge. The rest of the Defender's force may enter from any map edge during the Movement phase of turn 3,4, or 5. All of the remaining units must enter at the same time.

### WARCHEST

**Track Cost:** 1,000 WP

### OPTIONAL BONUSES:

**+300 Hornet's Nest:** The Defender adds two motorized Infantry platoons (Machine guns) per mapsheet of Veteran skill level. These units are deployed as Hidden units (see 259, TW) and are equipped with two LB-10X field guns.

**+200 Earthquake!:** Use the Earthquake rules with a strength rating of 3. (see p. 55, TO) The Earthquake strikes on turn 1d6+2.

### OBJECTIVES

**1. Keep the Commander Alive.** The Attacker's command unit must make it off the Attacker's home edge. **(Reward: +400 WP)**

**2. Tactical Withdrawal.** Exit as many Attacking units off the Attacker's home edge. **(Reward: +100 WP per unit before the Commander exits, +200 WP per unit after the Commander exits)**

### SPECIAL RULES

The following rules are in effect for this track:

#### Shielding

The Commander's unit can be defended using the Shielding rules (see p. 19, TO)

### AFTERMATH

It was as bloody as you expected. Every block was a meat grinder as the Robes came from every direction. But as the survivors from the Lament linked up with their brethren, the tables turned and it became the Blakists avoiding extermination.

### ADDITIONAL HOOKS

It's simple: There is still a whole lot more fighting to do before the Blakists give up and retreat. Are you up to it?

### NEXT TRACK

*Joy Ride*

## CHAOS ETERNAL: DEATH TO TYRANTS

### DEATH TO TYRANTS

*This was the last thing I expected, those idiots welcoming us with open arms. Calling us saviors after they overthrew our employers. With them offering us supplies and lodging, we figured why not, even for a few days until they got that HPG running again and realized whose side we were really on...*

—Journal entry, J78-112

### SITUATION

*Liberty, Contested Protectorate*

*1 April 3078*

With the Liberty Protectorate Militia decimated on Dieron, the Liberty system was left undefended for months. Capellan guerrillas, executing dozens of Blakist officials, claimed the system for Chancellor Liao. As you pulled farther back from fighting elsewhere in the Protectorate to lick your wounds, you landed on Liberty expecting a fight. Instead, a warm reception awaited from the locals, who thought you were the new arriving garrison force.

With everyone thinking you were some hired guns the Cappies sent to prevent giving the system to Stone, you unfortunately became a convenient target for every other power out there to take Liberty for itself.



## CHAOS ETERNAL: DEATH TO TYRANTS

**GAME SETUP**

Set up a mix of Mountain and Woodlands Terrain mapsheets (see p. 263, *TW*).

**Attacker**

The Attacker consists of up to 150 percent of the Defender's deployed force. The Attacker enters from any one map edge, declared before the start of the battle. Any aerospace units must start with a Velocity of 3 or less.

The Attacker is a mix of Com Guard Fifth Army and the Free World's League Home Guard. Both units are of Veteran skill level.

**Defender**

The Defender consists of forces from the player's unit, not to exceed 50 percent of their total available force.

The Defender sets up anywhere on the battlefield after the Attacker has declared their entry edge. In addition, the Defender declares/places three static gun emplacements per mapsheet no less than six hexes away from any map edge.

**WARCHEST**

**Track Cost:** 700 WP

**OPTIONAL BONUSES:**

**+200 Cream of the Crop:** Upgrade the Attacker to Elite skill level.

**+200 Orbital Support:** The Attackers may use Orbit-to-Surface Fire (see pp. 103-104, *SO*) using the warship NCS *Far Vision* (*Vincent Mk 42-class WarShip*).

**OBJECTIVES**

**1. Hold Them Back.** Destroy or Cripple at least half of the Attacker's forces (**Reward: +400 WP**)

**2. Being Difficult.** At least two-thirds of the Defender's force must be operational on the battlefield after Turn 12. (**Reward: +400 WP**)

**SPECIAL RULES**

The following rules are in effect for this track:

**Gun Emplacements**

The static fortifications are considered single-hex, level 1 Medium Buildings with a CF of 40 and an Armor Factor of 40. Each building can either have a turret-mounted Large Laser, a turret mounted LRM-20 with two tons of ammo, or an LB-10X AC with two tons of ammo. The gunnery crews have Gunnery skill 5.

**AFTERMATH**

As the task force approached the main base, your use of the automated defenses bloodied them enough that things degenerated into a quagmire for them. After a week of stalemates, both factions had high tensions and bitterness towards one another until Stone's lead negotiator Lin Murikami stepped in to work out a ceasefire.

Word reached you later that the Capellans were a trifle ticked off at you for the deception, handing the planet over to Stone in their name. Looks like Liberty is off-limits for future rendezvous.

**ADDITIONAL HOOKS**

Some of the guerrillas or more aggressive Coalition members may attempt to provoke another round of fighting, and Liberty was still a powder keg just waiting for the right spark.

**NEXT TRACK**

*Pound of Flesh*



## CHAOS ETERNAL: POUND OF FLESH

**POUND OF FLESH**

*"All Citizens report to your designated emergency shelters. This is not a drill. Capellan forces with WarShip support are invading! Please evacuate to your local shelter in due haste. Repeating. All Citizens report to your..."*

—Emergency broadcast, 4 May 3078

**SITUATION**

*Pleione, Contested Protectorate  
8 May 3078*

No sooner had you landed on Pleione than a large Capellan invasion force materialized overhead. Still angry at their humiliating loss the year before, they brought their WarShips into play, swatting away the system's space defenders and landing several regiments planetside.

The Confederation wanted to play hard ball this time. And you were caught in the crossfire.

## CHAOS ETERNAL: POUND OF FLESH

**GAME SETUP**

Set up a mix of Light and Heavy Urban Terrain mapsheets (see p. 263, *TW*). All Aerospace, VTOL, Fixed Wing, and WiGE assets enter the battlefield at no more than two less their Cruising/Thrust speed. The Attacker declares their entry edge before setup.

**Attacker**

The Attacker consists of up to 100 percent of the Defender's deployed force. The Attacker consists of elements of the Fifth Confederation Reserve Cavalry and the Fifteenth Dracon, both of Regular skill level.

**Defender**

The Defender is the player's unit, not to exceed 50 percent of their total available force. The Defenders also receive assets from the Pleione Protectorate Militia, of Green skill level and not to exceed 25 percent of the Player's deployed force.

The Defender sets up anywhere on the battlefield after the Attacker has declared an edge. In addition, the Defender openly designates one building where the Governor of Pleione is staying.

**WARCHEST**

**Track Cost:** 900 WP

**OPTIONAL BONUSES:**

**+300 Twilight:** This track takes place during Twilight hours (see p. 58, *TO*).

**OBJECTIVES**

**1. Hold Them Back.** Destroy or Cripple at least half of the Attacker's forces (**Reward: +700 WP**)

**2. Protect the Governor:** The Defender maintains control of the Governor's building hex by the end of the track. (**Reward: +300 WP**)

**SPECIAL RULES**

The following rules are in effect for this track:

**Orbital Support**

The Attacker may use Orbit-to-Surface Fire (see pp. 103-104, *SO*) using the *Ilsa Hyung* (*Feng Huang II* class WarShip).

**Capturing the Governor**

In order to take control of the Governor's building, an operational unit (including units that are Crippled but not Destroyed) must remain in the building hex or an adjacent hex for at least 2 turns. Units do not need to be in contact the entire time, but the player's force *must* maintain uncontested contact for 2 full turns. The building is considered to have a 2 level basement; the building may still be contested even if the structure is destroyed.

**AFTERMATH**

They came looking for vengeance but you gave them grief as you and the garrison force chewed through the Capellan regiments. Their numbers, combined with liberal use of their orbiting WarShip, however, became too much for you to handle. You retreated from the system with the rest of the survivors and watched on the trivid as the Confederation victors publicly executed the governor after his surrender.

**ADDITIONAL HOOKS**

You've got to contend with the Capellan naval forces during the mad dash out of the system. Though you've been recalled to Terra, there are a few other Capellan targets along the way that might serve to assuage your guilt.

**NEXT TRACK**

*Roadblock*

LATE 3078: DESTINATION TERRA

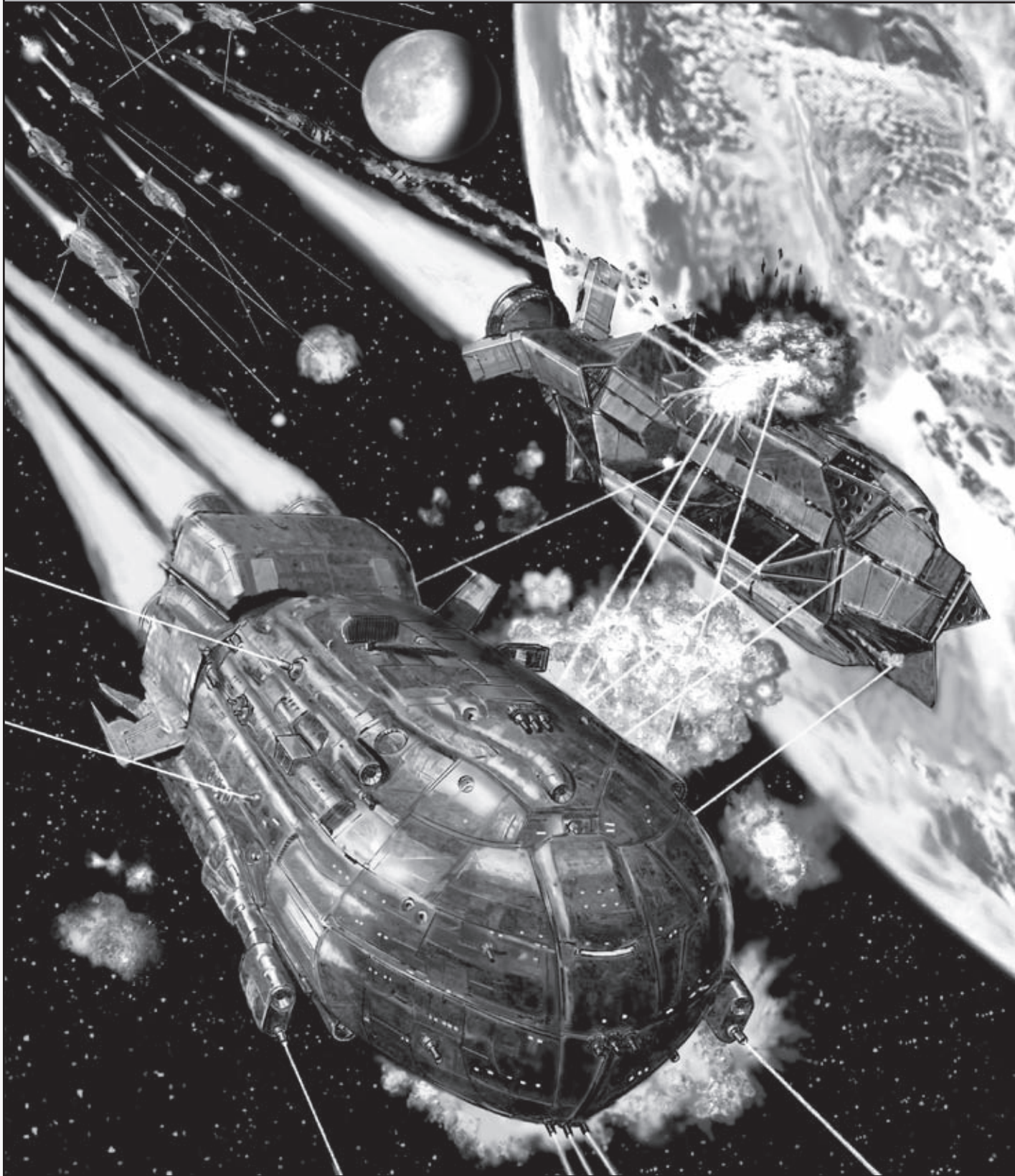



## DESTINATION TERRA

Having spent the early months of 3078 smashing down the wall of worlds around Terra, the allied Coalition found itself within one jump from humanity's home on all fronts by the end of June. Savage fighting had maimed every task force under Devlin Stone's overall command, but the surviving forces were even more determined and battle-hardened than ever. Whether Clan- or Sphere-born, the warriors (if not the officers) in the various task forces overcame their differences and united behind the ultimate goal of ejecting the Word from the Terran system. After consolidating their gains and sending in the scouts, the final mission to liberate Terra finally began on 16 August 3078.

As anticipated, the Word of Blake defense was intense, brutal, and swift. Having held onto the cradle of humanity for nearly twenty years, the Blakists had fortified every world and objective worth taking in a military campaign of this magnitude. A fleet of WarShips—including their new "Caspar II" drone vessels—defended the populated worlds of Terra, Luna, Mars, and Titan. Squadrons of fanatics, backed up by robotic ships created with the latest weapons, dueled with the aerospace forces of allied Houses and Clans for orbital supremacy. And for the brave crews who ventured close to drop their troops, defense batteries in space and dirt-side waited to spew forth ship-killing missiles, many armed with atomic warheads. What awaited on the ground was no less horrific; though the Word's infamous Manei Domini were few and scattered, their conventional defense forces, supported by homegrown TerraSec paramilitary troops, fought ferociously for every meter of soil. But when backed to the wall, the zealots were ready with scorched earth tactics; even the birthplace of mankind would feel the scars of nuclear devastation before the last holdouts admitted defeat.

Not since the days of Kerensky's liberation had war ever come to Terra, and never in history would the devastation be so widespread there. With so much at stake, it is little wonder that—even as war raged far beyond the boundaries of Terra's solar system—for those few months in the latter half of 3078, all eyes were on "Mother Earth" herself.

## GATHERING MIGHT

## UNPRECEDENTED ACCESS

>>BEGIN SEQUENCE 114-1//10Jul3078//Segment begins 2:48:22.1 (Terran Standard)<<

[View is of the command briefing room on the LAS Invincible. Center of the screen with his back to the camera is Devlin Stone, seated behind a large console facing a bank of monitors. Seated to his left at a low communications console are General Belle Lee and General Andrew Redburn. The wall of monitors show several group commanders.]

**[Devlin Stone]:** "...and as a reminder to you all, I am continuing to allow the embedded reporters to record our conversations and briefings for public record. However, these recordings will not be made public until after our assault is over, for good or ill. The people of the Inner Sphere deserve no less than full transparency in our drive to victory." [Pauses.] "Yes, Precentor Martial, go ahead."

**[image of Precentor Martial Victor Steiner-Davion]:** "To that point, Devlin, I have instructed Primus Dow to have all

## CLANNER'S VIEW

Almost by accident, I found myself in the forward observation lounge, and I was not alone. Standing at a window, looking out over the assembled fleet, was Star Admiral Amos Devon of Clan Ghost Bear, whom I recognized from an earlier meeting. It was one of those rare moments when any of the many military commanders attached to the upcoming operation was not engaged in some kind of planning session and was without their entourage of aides and subordinates. I knew this was my chance and it seemed as if the Star Admiral actually wanted to talk to someone.

"Of course I am disappointed in Stone's decision to exclude any Clan forces from the ground action on Terra, but I understand it. This campaign is far too important and we all must work together without our issues interfering," He remarked after a few moments of small talk.

Sensing an opening, I pushed ahead nervously. "We all know what Terra means to the Clans as a whole, Admiral, but can you tell me what it means to you personally?"

For a very long moment, I thought I had overstepped my bounds, but then he spoke, almost wistfully.

"In 2777, Hugh Devon was a midshipman on the SLS *Xbalanque* when the Great Father launched the liberation of Terra from the Usurper. Four decades later, his daughter Marie founded the Devon Bloodhouse among the Clans. I feel as if I have come full circle. My nature as a Ghost Bear wails that I am denied the earth of humanity's homeworld, but my blood as a Devon sings at the upcoming battle."

We spent the next ten minutes in silence, staring out into the crowded darkness of local space. Then, with a terse but polite goodbye, the Star Admiral departed for his own vessel. I can't say for certain, but I think I saw moisture glistening in his eye.

This is Karen Meimann, reporting from the *Invisible Truth*. Good night and good luck to us all.

—ISAP report filed on 11 July 3078

HPGs suppress and destroy any illegal transmissions of these proceedings until the date set by you and your council."

**[image of Duke Robert Kelswa-Steiner]:** [Mumbles harshly]

**[Stone]:** "Speak up, Robert. I want to make sure the microphones record your asinine commentary."

**[Kelswa-Steiner]:** "For the last time, Stone, it's 'Duke.' Show some respect at least for my position. After all, Skye has more than supp —"

**[Belle Lee]:** "Yes, Robert, we are aware of the sacrifices that Skye has made in men and material. You will, however, refrain from your noble divaship and accord respect to your operational commander."

**[Kelswa-Steiner]:** [Reddens] "How dare —"

**[image of Tai-shu Isoroku Kurita]:** "Shut it already, Duke. This briefing is about seizing Terra, not stroking your ego. That goes for the rest of you lot. If you cannot accord proper respect after nearly two years of Stone and Lee's exemplary success and sacrifice, perhaps it is time to withdraw with some made-up stress disorder—"

## LATE 3078: DESTINATION TERRA

**[image of Kanrei Kiyomori Minamoto]:** "Enough!"

**[Kurita]:** "Apologies, Kanrei."

**[Redburn]:** "Stone, can we go over the landing plan once more? I believe we're finally solid on Admiral Beresick's naval assault plan."

**[Stone]:** "Thank you, Andrew." *[Taps on keyboard]* "You have all had time to review our initial assessments of ground defenses surrounding your landing zones. I've revised the timetable to—"

**[Marshal Jon Davion]:** "Pardon me, Stone, for the interruption, but I wanted to address the assignment zones before you continue."

**[Lee]:** "Go ahead, Marshal."

**[Davion]:** "Frankly, I'm not happy with being assigned Rio. My command is still 75 percent effective and I believe I'd be of better use in the Geneva assault."

**[Kelswa-Steiner]:** "Glory hounding, like all of your line?"

**[Steiner-Davion]:** "That's enough, Duke Steiner. Marshal, most of your strength lies in battle armor troops. With the intel we have on the Rio Castle Brian, heavy 'Mech forces would be hard-pressed to seize the facility in a timely fashion."

**[Davion]:** "I understand, sir. But Geneva is a more critical target and I'm not convinced Duchess Marik nor General Redburn have the forces necessary to take the capital."

**[Stone]:** "Marshal, Rio is just as important. David is convinced that there is an operational SDS center there—"

**[Davion]:** "—which MIO has failed to confirm—"

**[Stone]:** *[Waves hand]* "And it's vital that system be rendered inoperative as soon as possible. If this is a false trail, then your forces will be vital as a mobile reserve."

**[Minamoto]:** *[Scoffs]* "We will not need Davion leadership in taking our targets. Cairo will fall quickly..."

*[Camera fades out as a cacophony of voices begin boasting their ultimate successes as Lee and Redburn sadly shake their heads. Stone is seen tapping on his keyboard and glancing back at the camera as it goes black]*

—Excerpt from the unedited *The Terran War* vid series, broadcast 9 January 3079

## RECON GROUP 4

(15 July 3078)

Location Censored [ISAP]—*[Shaky handycam shows the brightly lit face of a young reporter in front of a dull gray bulkhead]*

**[Reporter]:** "Hello and good evening, wherever you are! Tonight we will visit a couple of veterans from Recon Group Four, as they prepare to embark on—hopefully—their final mission: Terra!"

*[Camera swerves wildly, following the reporter through an airlock into a nearly empty hangar.]*

**[Reporter]:** "So, can you tell us what you will do tomorrow?"  
*[Cut to close-up of a bored-looking female soldier, clad in pilot's coveralls. Her nametag is blurred out.]*

**[Aerospace Pilot]:** "I'll wait in my fighter 'til they punch me out

of hangar. Then I'll see how wrong Intel was."

**[Reporter]:** "Interesting. How are you going to do that?"

**[Aerospace Pilot]:** "Well... mainly by getting shot at, probably. But hopefully by taking some good camshots."

*[Cut to a fully-suited battle armor trooper]*

**[Trooper]:** "Terra is a stronghold. The whole system. Ships, satellites, guns everywhere. We'll walk all the way in from the Kuiper Belt!"

*[Metallic laughter rumbles, cut to a brash looking man in cooling vest.]*

**[MechWarrior]:** "Tomorrow? I wait for hours in that stinky cocoon and bore myself to death."

**[Reporter]:** "And? Aren't you going to do some 'Recon'?"

**[MechWarrior]:** "I hope not! Have you ever seen a BattleMech in space? Better leave that to the fighter jocks!"

*[Cut back to the still bored pilot.]*

**[Aerospace Pilot]:** "Of course we don't want 'Mechs out there! If they are thrown out, we're in trouble... Or hitting paydirt."

*[A grin slowly spreads on her face. Cut to the MechWarrior, also grinning]*

**[MechWarrior]:** "Ever seen BattleMechs dishing it out on a WarShip? That would be something new. Whew... count me in!"

*[Cut to the battle armor]*

**[Trooper]:** "Just joking. We're all nervous, that's what is. Nobody really knows what's in there—in the system, I mean. The whole Coalition flies blind. And we're kind of their eyes... Wish us luck."

**[Reporter]:** "That we'll do, sir. Best of luck to us all."

*[Camera fading out.]*

## SEAT OF THE WORD

Recently, I managed to sit down with Stone's security chief Marcel Webb and squeezed some information out of him regarding what might be waiting for the Coalition's forces at Terra. Here's a transcript of our conversation:

**[Orloff]:** "So what exactly is the task force looking at?"

**[Webb]:** "Well, to be brutally honest here, we're not entirely sure. The last hard data we have on the system is pre-3057."

**[Orloff]:** "You mean, before the Word took the system from ComStar?"

**[Webb]:** "That's exactly right."

**[Orloff]:** "Now, I know we've had some information come in over the years from various assets. How much of a picture have you been able to truly piece together?"

**[Webb]:** "Well, the verifiable facts are less than we hoped for. But we've managed to piece together a decent conjecture, based on known data, current Word movements within the corporate and military sectors, and other data points. Overall, I believe we have a model of Terra's defenses and system nodes that is about seventy-eight percent accurate."

**[Orloff]:** "That's pretty low for an operation of this magnitude."



## TERRAN ASSAULT BEGINS

(16 August 3078)

Sian [CBS] — With the departure of Stone's Coalition force from their staging areas, it has become clear to all that his final assault on Terra has begun. With dozens of WarShips, hundreds of DropShips and thousands upon thousands of troops and 'Mechs, the assault easily dwarfs ComStar's ill-fated Case White.

It therefore has a chance of succeeding. But the cost will undoubtedly be tremendous, as Devlin Stone has failed to make use of the assistance the Chancellor has so generously offered. Without Capellan naval assets and the might of the CCAF, the losses incurred during Stone's campaign have already been unnecessarily high, especially on those worlds where poor communication and opportunistic power-grabbing placed his so-called Coalition forces against those of the Celestial Realm.

With Terra itself as the target, the casualties will only get worse.

On several previous occasions, Stone and his allies have proven their hostility towards the Confederation and its people. Stone himself has displayed his obvious bias by supporting Davion adventurism and exploitation, even as they do so under his banner. Even if one were to be generous, and presume there is any kind of validity to this behavior that simply is not obvious to any Capellan, it should be clear that Stone's decision to attack the cradle of humanity without Capellan support can only bode ill for all sides.

The fight for Terra promises to be far worse an endeavor than any prior assault by Stone's Coalition. We hope that the many lives that will be lost in the absence of our assistance will not be sacrificed in vain.

**[Webb]:** "It is. But it's enough for Stone and General Lee to formulate a solid plan of action, with several contingencies."

**[Orloff]:** "So what is it that we might be facing? Super-Al, massive moon-sized battle stations, orbital mass drivers?"

**[Webb]:** "Not so much, Yves. You know better than to give credence to shipboard scuttlebutt..."

**[Orloff]:** "Of course. But it does pass the time..."

**[Webb]:** "Well, to answer your original question, no, nothing of the sort. We do expect some seriously upgraded orbital defenses; ComStar has admitted that they were in the process of realigning and upgrading the entire Damocles system at the time of the Word's takeover. The Titan Yards are presumed to be heavily defended with aerospace and small ship support, and we suspect at least two of the lost WarShips from Case White may have been repaired."

**[Orloff]:** "That's a concern."

**[Webb]:** "It is, but we're looking at better odds due to the Clan assistance we now have."

**[Orloff]:** "What about rumors of a new Caspar system?"

**[Webb]:** "While ComStar admits to having a few of the Caspar relics back in the day, they're pretty confident the Word has not been able to mass-produce them, or purge the programming bugs that limited their use to extremely short operational parameters. We're expecting something akin to the old system, but I doubt they'll be a major factor in the defense of Terra. What concerns us most is the possibility of what WarShips the Word managed to sneak out of Gabriel before we managed to pin it down..."

## DESTINATION TERRA

—Excerpt of a report filed for the *Alshain Global Dispatch* by Yves Orloff, 29 July 3078

## FORCE BREAKDOWN

**[Orson Tanaka]:** "This is Orson Tanaka, Voice of the Dragon. With an agreement that this interview won't air until after D-Day, General Lee has graciously given us an exclusive on the eve of the final assault on Terra. Thank you General."

**[General Belle Lee]:** "Devlin felt it was important."

**[Tanaka]:** "Right." [two second pause in the transcript] "Tomorrow begins a coordinated attack on Terra. Units will be jumping in from over a half dozen planets."

**[Lee]:** "Correct."

**[Tanaka]:** "Given how long ComStar held onto Titan, I expect it will be a primary target for the initial attacks?"

**[Lee]:** "You'd have to ask Admiral Beresick about that. He's in charge of naval combat operations."

**[Tanaka]:** "Of course. Perhaps you could give us some idea of how the initial combat landings will go? What are the primary targets, who will be assigned to them?"

**[Lee]:** [Four second pause in the transcript] "Yes. Our targets will focus on key strongholds and vital centers. North America landings will be led personally by Commanding General Stone, who will be moving directly on Hilton Head. Galen Cox and Conner Sortek will make landings at Texas and near Unity City, respectively. The Eastern Front I will lead, with Duke Kelswa-Steiner and *Kanrei* Minamoto assisting. We'll be hitting major fortress locations from Japan to Egypt."

**[Tanaka]:** "Are you worried about spreading your forces out?"

**[Lee]:** "I'm not concerned. The Word is highly spread out, trying to defend hundreds of key locations. We're going to hit their major defensive formations and isolate those first. Then we'll move out to clean up the rest."

**[Tanaka]:** "What about Europe?"

**[Lee]:** "Europe is covered by specific target forces. General Rousset-Marik will be hitting Sandhurst, and General Redburn is tasked with securing Geneva. In addition Jon Davion is leading forces to take out the SDS command center in Rio and we're going to be sending Marcell Webb to deal with the Word on Luna."

**[Tanaka]:** "Very ambitious. What do you think your chances for success are?"

**[Lee]:** "What? Do you stay up late thinking up stupid questions like that? I'm done."

—INN Special Interview with General Belle Lee, INN, New Home, recorded 16 August 3078

## STONE'S ELITE

**[Nigel Holmgren]:** "To get the perspective of the common soldier, I spoke earlier today with three members of Stone's Lament."

## LATE 3078: DESTINATION TERRA

*[Image cuts to three soldiers sitting at a mess hall table.]*

**[Bryce Ruggieri]:** "What do I hope to do after the war is over? Sleep. No, seriously, I haven't thought that far ahead yet. I'm just hoping to make it through Terra, y'know?"

**[Vijay Jagadamma]:** "I think a lot of us are waiting to see what Stone will do."

**[Holmgren]:** "That will affect your post-war plans?"

**[Kennon McDaniels]:** "You bet. Those of us in the Lament, we'll pretty much follow him to hell and back after all we've been through together."

**[Ruggieri]:** "Damn straight."

**[Holmgren]:** "And how long have you been with Stone?"

**[Jagadamma]:** "Bryce and Kennon were on Kittery with him. Me, I joined up on Scituate."

**[Ruggieri]:** "Johnny-come-lately." *[Laughs.]*

**[Holmgren]:** "It's obvious that you are all very close to one another. But what about your families?"

**[Ruggieri]:** "Dead."

**[Holmgren]:** "I'm sorry."

**[Jagadamma]:** "Still on Scituate, as far as I know. Haven't spoken to them in...four years? Five?"

**[Holmgren]:** "And what about you, Sergeant McDaniels?"

**[McDaniels]:** "Parents're dead. But I have a little brother, Josh. I haven't seen him since I went into the camp. I'd like to try and find him if I can."

*[Holmgren voiceover as image cuts to an older gentleman who sits at the table. Camera zooms in on the haggard, pale face of the latecomer.]*

**[Holmgren]:** "Towards the end of our interview, a fourth veteran joined us. General Andrew Redburn may not be as physically strong as he was ten years ago, but he still has the presence of a hero. He was there to inform us of Devlin Stone's latest decision."

**[Andrew Redburn]:** "I am pleased that Stone has given the honor of first landing on Terra to the Liberators. Those men and women have suffered much at Blakist hands."

**[Holmgren]:** "Including yourself."

**[Redburn]:** *[Smiles.]* "Yes, including me."

**[Holmgren]:** "General, what are your plans for after the war?"

**[Redburn]:** "Let's cross that bridge when we get to it, eh, Nigel?"

—INN report filed by Nigel Holmgren on 1 August 3078

### TIME ON TARGET

(3 August 3078)

Terra [SBC] — Buzzing by the Blakists at more than 100,000 kps! Apologies in advance for any errors in the below. It was all explained to me properly by my hosts, but daddy didn't raise a spacer.

I've been spending time with the Belters for several weeks now, and their society is unlike anything I could have imagined.

Their life is so different as to be almost alien. And by all accounts, their existence has barely changed under Blakist "occupation." We've been trying to glean what the Belters know of the Blakist defense of the "interior," and during one such expedition, a "captain" Ospherous McMac took us aboard his vessel. He wanted to show us something.

What followed was many long days of very high-G burns straight into the solar system. Our captain was merciful in allowing us frequent breaks from the strains weighing several times our own mass. He never did tell us how hard he was pushing us, although Ensign Lewis told me he was convinced it exceeded 4 Gs.

The torture seemed unbearable, but in the end it paid off. Ospherous took us to his bridge one day, burning a leisurely 1.5 as he put it, and showed us Saturn. We were going so fast, it was visibly growing larger. After the initial shock, I realized what this meant. Titan! He was taking us past Titan at an insane speed.

The insanity became even worse as McMac began adjusting the angle of our braking maneuver at random times and random angles. "Don't need them throwing trash in our path as we zoom by like a PPC bolt." It was then that I truly began to get scared.

The Yards became visible and approached at a truly staggering rate. I was unprepared, even as Lewis began tittering about WarShips and Caspar drones. Alarms began going off all over the bridge; it was "Blake calling," according to our mad captain. My screen told me that a Blakist force capable of crushing fleets was wholly focused on my tiny vessel, while my stomach told me McMac had dispensed with gentle angles and leisurely brake rates. For one brief moment, I was convinced we would collide with the Yards themselves.

And just as the chaos seemed to reach a crescendo, it ceased. We had passed the yards at a considerable distance. Everything seemed to calm down.

"All right, it's very gentle now. Be back in the Belt before you know it."

I was as shocked as anyone else when I heard myself ask: "Can we go again?"

### ROLL CALL

(14 August 3078)

Unknown [DBS] — *[Myra Kellison stands in a reinforced jumpsuit, tight cuffs at the neck, wrists and ankles. The generic structure of a DropShip fills the screen behind her.]*

"Myra Kellison, on the doorstep to Terra. That is correct, we are finally heading to the 'cradle of humanity.' Twenty-six WarShips will escort innumerable regiments. While this may sound like an insurmountable force, we shouldn't get too assured that this next step will be anything but tough, even under Stone's guidance.

"These aren't a bunch of troops preparing for one battle; they have endured a harrowing year and a half of invasion following



**CLANS: WITHDRAWN?**

(18 August 3078)

Undisclosed [INN] — *[Inside of a spacecraft, a see-through panel shows a horde of ships of all sizes, from a massive Leviathan down to smaller, indiscernible craft. A blonde female reporter stands to the side, her curly hair splayed out like a halo.]*

"Hello. This is Cristen Garner reporting to you from an undisclosed location where the assault upon Sol is about to begin. Behind me you can see the fleet, comprised of ships from all nations, including the Clans. Such an assemblage of firepower far surpasses anything that this universe has seen since the last time a Kerensky went to call upon Terra.

"But if you could look closer, inside those DropShips, you can see what is missing. There are Com Guards, Lyran Guards, Davion Guards, all sorts of guards, but not a Clanner to be found. I think there are even some individual Capellans involved, but not a single one of some of the most fearsome warriors in the Coalition. Where are they? No one will say. Well, no one who knows. There have been all sorts of supposition. 'The Clans have been sent off to Gibson.' Or they are 'headed to smack down Circinus.' Or even cleaning up all the lingering conflicts in the former Protectorate. One soldier even told me that Stone has the Clans 'poised to hit the Successor State capitals again,' if they don't accept Stone as a new Lord.

"As you can see, some of these ideas *are* a bit farfetched. But nonetheless, the Clans aren't here. How did Stone manage to pull this off? Surely the Clans must have wanted to be part, especially given the Bears' animosity toward the Blakists. Was there perhaps a quiet trial by Stone or one of his proxies? Perhaps he managed to convince them that they would spend too much force fighting one another for the right to land. In any event, the fight on Terra's soil will be done without the Clans."

**DESTINATION TERRA**

years of defending against Blakist assaults. Some units, such as our Twenty-fifth Arcturan Guards, are at full strength and ready to end the Blakist threat. Other units, such as ComStar's First Army, are barely functional. The Lyrans have contributed nine units, while their Combine counter-parts have dispatched twelve commands. There are ten FedSuns forces while Stone and the mercenaries add thirteen more. There are even eight former Free Worlds units and the Com Guards are ready to go with three more.

"You may also notice what is missing. No Clan ground forces, no Capellans, no Periphery allies. Morale is high despite most units seeing extensive damage at one time or another. Most units are heading into the fight at two-thirds or three-quarters strength. The enemy may have more units than expected, given the Word's history. And much like the last great invasion of Terra, some troops will likely be lost trying to fight past the spaceborne defenders. But with good leadership, determination, and plenty of blood and sweat, we will prevail."

"Because there is no other choice."

**CLASSIFIED: EYES ONLY – TOP SECRET****RELEASE TO:** Task Force Commanders, Operation SCOUR

The following forces are to take part in operations beginning 08:00 Zulu, 15 Aug 3078.

**Task Force CRONUS**

**Mission:** Neutralization of Titan Yards

**Commander:** Admiral Alex Douglas

**Composition:**

LAS *Robert Marsden* (Fox-Class) – Lyran Alliance

DCS *Lair of Mighty Wyrms* (Tatumaki-Class) – Draconis

Combine

CGB *Great Bear* (Leviathan II-Class), CGB *Ursus Major* (Nightlord-Class) – Ghost Bear Dominion

CSR *Ark Royal* (Conqueror-Class), CSR *Blue Quest* (Aegis-Class),

CSR *Corvidae* (York-Class), CSR *Drake* (Whirlwind-Class) – Clan Snow Raven

CJF *Blue Talon* (Aegis-Class), CJF *Jade Aerie* (Black Lion-Class),

CJF *White Aerie* (Black Lion-class), CJF *Green Lantern* (Congress-Class), CJF *Hawker* (Sovetskii Soyuz-Class) – Clan Jade Falcon

CW *Stealthy Kill* (Black Lion-Class) – Clan Wolf

**Task Force EARTHBOUND**

**Mission:** Neutralize naval defenses around Terra, secure landing zones.

**Commander:** Precentor-Admiral Alain Beresick

**Composition:**

CSV *Invisible Truth* (Cameron-Class) – ComStar

ISS *Excalibur* (Zechetinu II-Class) – Coalition

LAS *Invincible* (Tharkad-Class), LAS *Katherine Steiner* (Fox-Class), LAS *Katrina Steiner* (Fox-Class) – Lyran Alliance

DCS *Takashi* (Kirishima-Class), DCS *Dieron Star* (Kyushu-Class),

DCS *Victory At Wolcott* (Kyushu-Class) – Draconis Combine

AFS *Indomitable* (Fox-Class), AFS *Admiral Michael Saille* (Fox-Class) – Federated Suns

NCS *Blade* (Aegis-Class), NCS *Chronicle* (Aegis-Class), NCS

*Path of Honor* (Aegis-Class), NCS *Promise* (Aegis-Class), NCS

*Remembrance* (Aegis-Class), NCS *Future Triumph* (Fredasa-Class),

NCS *True Vision* (Congress-Class), NCS *Far Vision* (Vincent Mk42-

Class), NCS *Hunter* (Lola III-Class), NCS *Ranger* (Lola III-Class), NCS

*Anna Rosse* (York-Class) – Clan Nova Cat

DSS *Blood Lust* (Aegis-Class), DSS *Terror of the Deep* (Nightlord-

Class), DSS *Kraken* (Potemkin-Class), DSS *Red Tide* (Potemkin-Class)

– Clan Diamond Shark

CGB *Rasalhague* (Leviathan II-Class) – Ghost Bear Dominion

**Operation SCYTHE****Mission:** Neutralize Word of Blake ground forces, capture principle targets.**Overall Commander:** Commanding General Devlin Stone**Task Force SICKLE****Primary Mission:** Eliminate Enemy Command & Control, Neutralize SDS Command Center**Commander:** Commanding General Devlin Stone**Composition (by Target):****Target:** Hilton Head – Eastern North American Seaboard**Commander:** Commanding General Devlin Stone

Stone's Lament – Coalition

25th Arcturan Guards – LAAF

3rd Free World Legionnaires – FWLM

Ryukun-ni – DCMS

7th Pesht Regulars - DCMS

Ghost Legion – Mercenary

**Target:** Texas Highlands**Commander:** General Galen Cox

1st Davion Guards - AFFS

Marlette CrMM - AFFS

15th Arcturan Guards - LAAF

Hansen's Roughriders - Mercenary

12th Vegan Rangers - Mercenary

**Target:** Pacific Northwest**Commander:** General Conner Sortek

3rd Lyran Guards - LAAF

17th Benjamin Regulars - DCMS

**Target:** Rio de Janeiro**Commander:** Marshal Jon Davion

5th Crucis Lancers - AFFS

Iron Guard - FWLM

20th Marik Militia - FWLM

**Target:** Sandhurst**Commander:** General Alys Rousset-Marik

12th Atrean Dragoons - FWLM

7th Donegal Guards - LAAF

Devil's Brigade - Mercenary

Fifth Army – Com Guards

**Target:** Geneva**Commander:** General Andrew Redburn

Fox's Teeth - AFFS

Stone's Liberators - Coalition

Home Guard - FWLM

Sixth Army - Com Guards

5th Lyran Guards – LAAF

**Target:** Mars**Commander:** To Be Determined

Stone's Liberators - Coalition

7th Donegal Guards - LAAF

Alpha Galaxy – Clan Nova Cat

11th MCAV – Clan Hell's Horses

Alpha Galaxy – Clan Wolf in Exile

**Task Force MALLETT****Primary Mission:** Capture Castle Briens, Deny Infrastructure to Enemy, Neutralize Enemy Forces**Commander:** General Belle Lee**Composition (by Target):****Target:** Moscow**Commander:** Duke Robert Kelswa-Steiner

Skye Guards - LAAF

7th FW Legionnaires - FWLM

31st Marik Militia - FWLM

**Target:** Sydney**Commander:** General Belle Lee

Stone's Stalwart - Coalition

Ryukun-san - DCMS

8th Dieron Regulars - DCMS

17th Arcturan Guards - LAAF

1st FedSuns Lancers - AFFS

1st New Ivaarsen Chausers - AFFS

8th Deneb Light Cavalry - AFFS

Northwind Highlanders - Mercenary

**Target:** Athens**Commander:** Tai-sa Albert Benton

Sorenson's Sabres - DCMS

The Battle Corps - Mercenary

**Target:** Cairo**Commander:** Kanrei Minamoto

1st Sword of Light - DCMS

2nd Dieron Regulars – DCMS

Stone's Revenants - Coalition

Kell Hounds - Mercenary

**Target:** Babylon**Commander:** General Leandro Amurri

Juggernaut - FWLM

30th Marik Militia - FWLM

6th Benjamin Regulars - DCMS

**Target:** Tokyo**Commander:** Tai-shu Isoroku Kurita

1st Crucis Lancers - AFFS

23rd Arcturan Guard - LAAF

2nd Genyosha - DCMS

**Target:** Singapore**Commander:** General Thomas Hogarth

First Army - Com Guards

2nd Davion Guards - AFFS

Kentares DMM - AFFS

5th FW Guards - FWLM

**Target:** Luna**Commander:** Colonel Marcel Webb

DEST - DCMS

Alpha Galaxy – Clan Jade Falcon

Delta Galaxy – Clan Wolf

Star Seeds – Mercenary



## LATE 3078: DESTINATION TERRA

**TERRA: THE  
ATTACK BEGINS****MARS ATTACK?**

(14 August 3078 [Filed 16 September 3078])

CSV *Invisible Truth* (FSNS)—Report by Field Reporter Tomas Fraylee.

**[Fraylee]:** "This is Tomas Fraylee, FSNS reporting live outside of the Command briefing room onboard the CSV *Invisible Truth*. Any moment we expect to catch a glimpse of the war room and perhaps have a word with one of the commanders of the mission to liberate Terra, where it all began."

*[Camera pans back and forth between a group of reporters and two Clan Ghost Bear Elementals standing guard outside. They glare at the cameraman, who quickly refocuses on Fraylee.]*

**[Fraylee]:** "So far the operational details of this critical mission have been...wait...the door just opened."

*[The camera angles back through the door and zooms in on a group of the Inner Sphere's greatest military minds as they sit or*

*stand around an immense holotank filled with thousands of points of light. The view is suddenly eclipsed by a dark shadow as an imposing man enters through the room's portal. Instantly, a feeding frenzy ensues as reporters rapid-fire their questions at the newcomer as fast as they can get their words out.]*

**[Fraylee]:** "Mr. Stone! Mr. Stone, a word please?"

*[Tomas floats purposely into Stone's path. Stone arrests his movement, scowling. The Elemental bodyguards roughly grab Fraylee and start to remove him.]*

## HIGHEST HONOR

(15 August 3078)

Titan [ISAP] – Intercepted Ghost Bear communications between Khan Aletha Kabrinski and Star Admiral Tome Gurdel.

>>**Security Intercept: 08:47TST-CGB-2195HP**<<

**[Star Admiral Tome Gurdel]:** "My Khan, we have taken the Titan Shipyards and destroyed the Caspar-II system in its entirety."

**[Khan Aletha Kabrinski]:** "Star Admiral Gurdel, the transmission from Star Admiral Devon was terminated mid-broadcast. Since you are making this report I assume that he is unable to do so, *quiaff?*"

**[Gurdel]:** "Aff, they disguised a launch platform as an ore processor. It fired a several nuclear warheads at point-blank range on the *Great Bear*. They died honorably serving the Clan."

**[Kabrinski]:** "A *Leviathan* destroyed in mere moments... By Kerensky's Blood these *savrashi* Blakists must pay!"

**[Gurdel]:** "We pounded her defiler into scrap but a second of these disguised platforms lay hidden beyond the shipyards. It unleashed a salvo into the *Hawker* before our assault DropShips could deal with it. We lost several more of our escorts including the *Corvidae*, and the *Green Lantern* to groups of Caspar drones as we lay siege to the Yards. These *surats* have no concept of honor."

*[The broken hull of the Great Bear can be seen as it drifts slowly beyond the central viewport.]*

**[Gurdel]:** "My full report is attached. Problematically, my own *Ursus Major* was wounded from a Peacemaker hit along our keel and a string of Killer Whale strikes to our stern. We need time for repairs."

**[Kabrinski]:** "You will be ready for Terra, *quiaff?* I would have you there."

**[Gurdel]:** "Neg, my Khan. There may be damage to our K-F drive. I do not recommend it."

**[Kabrinski]** "Make your repairs and come quickly. Terra calls to us."

**[Gurdel]** "Aff, my Khan. Much honor was gained here on the cusp of our Terran home. Despite our losses, we are victorious."

>>**End Transmission**<<

## INTEL UPDATE

**[Star Admiral Amos Devon]:** *[A highly stressed man with a large forehead addresses the camera. His voice is harried and bridge noise can be heard in background]* "Admiral Beresick, I believe we have concrete evidence that the Word has managed to expand the Caspar drone system. My gunners have just destroyed a capital missile-equipped DropShip barely before it entered optimal range of its non-capital armament.

"It appeared to be one of those rumored *Tiamat*-class Pocket WarShips, but unless the entire crew is robotic, it's most likely a drone ship. We have it pulling five and a half gravities through multiple turns with no noticeable degradation in performance. We even put a NAC round right through the bridge area and the damned thing still kept coming."

**[Sensor Tech Akaris]:** "Star Admiral, missile launch! Range thirty-six kilometers."

**[Devon]:** "Stravag! How did something get that close?"

**[Sensor Tech]:** "Launch is originating from that ore processing station. Star Admiral, I have thirty capital missiles on an inbound track. Performance profile indicates Peacemaker class."

*[Devon turns back to the visual pickup.]*

**[Devon]:** "Admiral, I am transmitting our scans of this ore processor. It has been an honor and a privilege." *[Devon turns away, shouting.]*

"Helm! Full evasive! Tactical, set computers to maximum anti-missile! All hands, brace for multiple impacts!"

—Final transmission from the CGB *Great Bear* near the Titan shipyards, 15 August 3078

## LATE 3078: DESTINATION TERRA



**[Fraylee]:** "Could you tell our viewers why you have decided to forgo Mars and hit Titan instead? Isn't Mars a far deadlier threat to the Task Force and this operation?"

*[Stone narrows his eyes, shaking his head once. The room is silent.]*

**[Stone]:** "It will be dealt with in due time."

*[He begins to move past the reporter.]*

**[Fraylee]:** "What about the Dragoons? And Case White? Don't they matter? Don't they deserve closure?"

*[Stone stops and turns.]*

**[Stone]:** "They all matter."

## HERO OF THE HOUR

*[View opens on Orson Tanaka beside a young man in the flight suit of a DCMS aerospace pilot.]*

**[Tanaka]:** "I am honored to be here with *Chu-i* Shinjo Sakai. For reasons of operational security, I cannot divulge his exact assignment; however we can inform you that the *Chu-i* was instrumental in the success of the Alliance forces in the Battle for the Titan Shipyards that ended only a few hours ago. *Chu-i*, thank you for making time to speak with us."

**[Shinjo Sakai]:** *[Bows briefly.]* "You are welcome, Mr. Tanaka."

**[Tanaka]:** "Can you give our viewers a feel for what the battle for Titan was like?"

**[Sakai]:** *[Pauses.]* "I very much doubt it, *Tanaka-san*. It is difficult for people who have not witnessed warfare in the lifeless vacuum of space to understand the full scope of it."

**[Tanaka]:** "Surely you can tell us how you managed to deliver such a critical strike to the zealots?"

**[Sakai]:** "You want to hear that it is my Combine blood and skill that won the day? Surely, the discipline ingrained in me during my service to the Dragon was the key to holding my nerves. However, large space battles are more chance than skill. Massive destruction occurs on an unimaginable scale in a matter of moments. All any one pilot can do is stay alert, fly as fast as possible, and trust that if he is meant to live he will. I will say this much: I have been in more battles now than I can recall in detail. None of it, not a single moment of all that fighting, prepared me for the sheer scale and ferocity of the battle for Titan."

—VOTD Broadcast Interview, 16 August 3078

## TERROR AT TITAN

(17 August 3078)

*[Camera image opens onto the bridge of a WarShip. Myra Kellison stands in profile and to the side, next to an older gentleman in a pristine white uniform.]*

**[Myra Kellison]:** "From the bridge of the *Invisible Truth*, this is Myra Kellison. The *Truth* has arrived at the Titan Yards after receiving the 'all clear' signal from the Coalition naval assault force. Admiral Beresick joins us now to give us a brief update. Admiral?"

**[Alain Beresick]:** "I will be brief, Myra, as we're continuing mop-up operations."

**[Kellison]:** "Of course, Admiral."

**[Beresick]:** "Roughly five hours ago, a naval force of predominately Clan WarShips from the Coalition fleet jumped in at a pirate point located near the Yards. Defense of the Yard was extremely heavy, including scattered space mines, rigid fire lanes, several WarShip hulls, and a very vigorous aerospace defense. Of particular note was the presence of a large Caspar drone network, which managed to converge and annihilate the brave crews of the *Blue Quest* and *Green Lantern* in short order. However, their sacrifices allowed the *Great Bear* and the *Lair of Mighty Wyrms* to close in on the main aerospace docks and open up an avenue of attack for our fighters.

"I won't lie to you, Myra—the fighting was brutal. We were able to monitor our task force's progress through the valiant actions of the *Arc Royal* and *Blue Quest*, who kept constant HPG contact with us here on the *Truth*. I'd be lying if I said I didn't want to charge in there with everything else, but with recent Blakist tactics, we—meaning Stone and myself—couldn't take the risk of leaving all these JumpShips and troops unprotected."

**[Kellison]:** "So Admiral, what's the final count? If the fighting was, as you said, 'brutal,' then how much did this victory cost us?"

**[Beresick]:** "Too much, Myra. Too damned much. Our Clan allies fought like nothing I've ever seen before and managed to overcome the relentless hordes of drones, pocket WarShips, and fighters. However, losing the *Great Bear*, *Corvidae*, *Hawker*, *Stealthy Kill*, and the other ones I mentioned earlier will be felt when we move to Terra.

**[Kellison]:** "So a Pyrrhic victory, then?"

**[Beresick]:** "Absolutely not! More like an honorable one. These Clan crews are the finest naval crews I've ever had the pleasure to serve with and fight alongside. If our next assault has even half of the honor and bravery as what I've seen from today's reports, you'll be standing on Terran soil before too long."

**[Kellison]:** "Thank you, Admiral."

## CAPTAIN'S LOG

(26 August 3078)

The fighting has died down for now, with only sporadic skirmishes between lone survivors and our fleet. Only four hours and so much destruction and death happened here. At least we carried the day and claimed our prize. Or what is left of it. Preliminary surveys shows that probably two thirds of the yards were destroyed in the battle, either by Blakist sabotage or by our own guns as we rooted out weapon platforms and hidden forces.

What was planned as a relatively easy operation turned sour the moment we jumped in. Somehow they were waiting for us, with a fully operational Caspar II system heading up the defenses. Our fleet had barely cleared the jump points before the first wave of Blakists caught us. Aerospace fighters and long range missiles lead the attack, followed by a horde of pocket WarShips and three WarShips, the *Deathblow* (*Essex-Class*), *Narbonne* (*Dante-*



## LATE 3078: DESTINATION TERRA

Class) and *Manchester* (Suffren-class). All of them salvage from Case White, according to the initial records we're finding.

Our forces were arrayed in two naval "Stars": the Ghost Bears and Ravens in one, and the Wolves and Falcons in the second, with us and the *Lair of Mighty Wyrms* held in reserve and command. The difference in attitudes between the two Stars was apparent from the start. Without much time to drill coordination, it showed that the Ravens and Ghost Bears have been working together for close to two years now, while the Falcons and Wolves each tended to rely on themselves instead.

Apart from the opening salvos from the Caspars, the lack of nuclear weapons amongst the Word's forces seemed odd. But as Dieron showed, the Blakists might be running low and saving them for Terra. Of course, the reason why they didn't use nukes became crystal clear when the new "Fire Blossom" showed its deadly bloom. A dozen Peacemaker warheads among several dozen dummy missiles, all launched at almost point blank range from a seemingly destroyed installation. Poor Bears, even a *Leviathan* couldn't survive that attack. I'm glad I don't have to be the one to tell the Bear Khan that they are down to just one *Leviathan* now. At least we now know how the damn trap works so hopefully they can be avoided at Terra.

Half a dozen dead ships on our sides, the rest really not fit for further combat. I really hope Beresick isn't counting on any relief from us at Terra, because it'll be a long time coming...

—Excerpted from the Captain's log of the *LAS Robert Marsden*.

## SIGNALS FROM HOME

(19 October 3078)

Sol [INN] — We have assembled some broadcast clips for our audience; a sampling of what an average Terran viewer has seen and heard over the past few months. These broadcasts were picked up by some of the Coalition fleet massed at Titan.

[A typical newsroom is seen, with an unremarkable male reporter.]

**[Reporter]:** "In local news, the jobless rate is up to 5.3 percent, a rise of 0.2 percent over the past month. Experts claim this is due to the increased fighting as Protectorate forces continue to defend against the enemy's wanton incursion. The long-term outlook is better, as construction projects will jump-start hiring." [Pause.] "And for a sunny forecast, here's Jenny."

[The scene switches to a different newsroom. A female reporter with dark hair and olive skin sits behind the desk.]

**[Female Reporter]:** "We interrupt your regularly scheduled broadcast for late-breaking news. Clan forces have invaded the Sol system and have engaged our fleet and defense systems around Saturn's moon of Titan. It is not known if they are merely after the shipyards at this time, or if an invasion is imminent. Terra, Mars, and Venus do not appear to be in danger at this time. Stay tuned for further updates. Only Green-level travel

restrictions are in place. We now return you to your scheduled programming."

[The scene changes. Studio monitors are dark and there is no one in the background. A long figure is seated behind a desk. His white robe bears the insignia of a Precentor while the hood hides most of his features.]

**[Voiceover]:** "Welcome to the *Sunday Night Fright Zone*, with your host, Master Terror!" [Canned applause.]

**[Robed Figure]:** [Figure doesn't move.] "Tonight's offering is quite timely, if I do say so myself. Our good brethren have recently managed to steal this movie straight off the reels just for our audience." [Screen above the figure flashes movie stills in a flowing panorama, timed with the figure's speech.] "We'll be showing you the full, unedited version of the latest Tharkad world-seller *A Prince and His Army*, starring the ever-versatile Vacxim Stig-Dovian alongside relative transgender newcomer Elvin Nosted. It's a great biopic about a mentally challenged noble and his quest to prove himself worthy of the king's attention while battling his sister and her succubi and a reptilian invasion fleet. Nosted delivers a fine performance as the evil puppetmaster, truly worthy of the Best Supporting Actor award won last year at the Tharkad Academy Awards."

[Camera zooms in closely on the figure's cowl, where two green "eyes" appear.]

"As always, our great crew here at the *Fright Zone* will interject with our witty commentary, short skits, and other jabs that make the *Zone* your Sunday night comedy home. So stay tuned for this exclusive showing!"

## TERRA: D-DAY

## BEGIN THE ASSAULT

>>DBCМК1:0023 (Terran Standard), 17-AUG-78<<

[Camera fades up onto the smiling face of Myra Kellison. Behind her can be seen part of the bridge holotank, flooded with various ship icons and colors. Floating inside the tank is Admiral Alain Beresick.]

**[Myra Kellison]:** "I'm Myra Kellison. I'm standing on the bridge of the *Invisible Truth*, a familiar sight to many of our viewers by now. Behind me is the bridge's main holotank, showing the current disposition of the task force located around us as we prepare to leave Titan Yards."

**[Unidentified Voice]:** "K-F drive reading one-hundred percent. Ready for jump, Admiral."

**[Kellison]:** "According to Admiral Alain Beresick, whom you can see behind me, the task force is preparing for the historic jump to a pirate point near Terra, where the final assault on the Word of Blake will begin in earnest." [Camera zooms towards holotank, where at least ten different miniature WarShip images can be seen.] "Now, from what I've been told by the Admiral's

## LATE 3078: DESTINATION TERRA



staff, we are not the sole force moving towards Terran orbit, but will be, as the Admiral put it, 'using the Blakists' tactics against them.'"

*[Camera rotates back to Kellison.]*

**[Unidentified Voice]:** "Weapons all green, Admiral!"

**[Kellison]:** "While I don't understand the strategic plan, I do know that the flotilla about to hit Terra will be the largest since the days of General Aleksandr Kerenksy's own liberation campaign."

**[Unidentified Voice]:** "Communications, check. Relays primed and set to go, Admiral."

**[Kellison]:** "All around me, the bridge crew is conducting last-minute checks on all systems in preparation for our jump. The Admiral will be making a short—ah, he's ready now..."

*[Camera rotates and frames the Admiral.]*

**[Alain Beresick]:** *[Looking straight into the camera eye.]*

"At this moment, we stand on the cusp of something greater than ourselves. For over a decade we have fought against the greatest threat to our humanity since the days of the Usurper, whose presence also tainted the cradle of our history. Right now, we are the stepping stone to cleansing the stain that threatens to envelop us all in ruin."

*[He pauses, looking down and then turns to face the bridge crew as the camera zooms back.]*

**[Beresick]:** "We have prepared to our best for what lies ahead. Honestly, we've done everything we can to be ready and I'll be honest—I don't think it's enough. The horrors we witnessed here at Titan show us that our enemy is prepared, determined, and merciless. These are a deadly combination to any average foe."

*[Beresick glances at each person, then smacks a fist into an open palm.]*

**[Beresick]:** "Therefore, we *must* be more than average. We *must* be superior. We *must stand tall* no matter the odds. *Whatever* lies ahead, *whatever* dark nightmare and gnashing teeth rear their head, our vigilance and our duty demands we stand strong and fight to our last. It is all we can do, and all we hope to do."

*[He turns back to the camera, staring steadily as the camera zooms back in.]*

**[Beresick]:** "And in that hope, lies our victory."

*[He pauses, his eyes roaming as if searching for something off camera.]*

**[Beresick]:** "Long ago, a famous blue water commander faced down his death on the open seas. He did not flinch from the face of darkness and did not falter against the odds, stacked as they were. 'It is a warm work,' he said to a lieutenant, 'and this day may be the last to any of us at any moment. But mark you well, I would not be elsewhere for thousands.'"

## IT IS TIME



*[Nigel Holmgren stands on the bridge of the LAS Invincible. Around him, uniformed men and women move about purposefully, but not in chaos. Devlin Stone himself floats near the Captain's chair.]*

**[Holmgren, in a low voice]:** "Ladies and gentlemen, this is Nigel Holmgren reporting for INN. In moments, Devlin Stone himself will give the historic order to begin the Alliance assault to liberate Terra."

*[A young officer approaches Stone and says something to him quietly. Stone nods once as the officer moves away.]*

**[Devlin Stone]:** "Captain, if I may?" *[The captain nods.]* "Mister Patterson, open the fleet channel please."

**[Ensign Patterson, off camera]:** "Aye sir, opening channel to all fleet vessels." *[Pause]* "Fleet channel is open, sir."

**[Stone]:** "To every member of the Alliance now listening to my voice, you have my respect and my gratitude. What we are tasked with this day is perhaps the most significant event in all of human history. Even Amaris the Usurper himself did not visit such destruction and genocide as the Word of Blake has utilized during its senseless campaign of terror. We here today have taken a stand against their insanity and pointless violence. We have taken it upon ourselves to end their reign of terror on behalf of all mankind."

"We have battled the Word of Blake on world after world. We know all too well of the barbaric and desperate tactics they will employ to hold power for even a few more fleeting seconds. We know the cost they will demand for their removal. Yet Terra is not simply another world to be liberated. It is our home. It is our history. It is the womb from which we crawled out into the galaxy and created the Inner Sphere itself. Terra is the most sacred planet, the most hallowed of grounds and it is in the hands of the most ruthless and evil forces that humanity has ever been plagued by. That must change, and today it will."

"You have all sacrificed to be part of this historic assault. You have set aside ancient differences. You have left families and cherished friends behind. You have faced death time and again. You have made the choice to do what must be done not because it is easy or filled with the promise of glory. You have made the choices and sacrifices to be here because you know in your heart it is right and it must be done."

"What follows moments from now will be the largest incursion ever made into the Terran system since the time of Aleksandr Kerenksy. The cost for Terra will be high. We cannot know who among us will survive this victory and return again safe home. What we can know, with unerring certainty is that no one in this force will ever be forgotten. Those of us who survive these days and weeks ahead and once again bring freedom to mankind's birthplace will remember the fallen in eternity. Our names and deeds will echo throughout history as those who answered the call. Good luck and Godspeed to you all."

*[Stone turns to Fleet Admiral Johanna Gaines, standing off to the side.]*

**[Stone]:** "Admiral Gaines, It is time. Begin."

—INN Broadcast from the LAS *Invincible*, 17 August 3078



## LATE 3078: DESTINATION TERRA

*[He opens his arms, looking around at his crew.]*

**[Beresick]:** "I stand ready to vault us into the teeth of the beast. And I know, with the courage, the sacrifice, and the blood of all who go with me..."

*[Beresick pauses and looks again into the camera with a piercing gaze.]*

**[Beresick]:** "We. Will. Prevail."

*[He smiles, winks, and turns to his crew.]*

**[Beresick]:** "All ships, jump on my command."

*[Beresick glances around as the camera zooms and rotates back toward Kellison.]*

**[Beresick]:** "Mark."

**[Kellison]:** *[Tears clearly visible at the corner of her eyes.]* "And so we go..."

*[Camera feed ends as the jump drive ignites.]*

## THE FINAL DANCE

>>DBCCK2:0059 (Terran Standard) 17-AUG-78<<

*[Camera struggles to focus on a disheveled Myra Kellison. Behind her can be seen a shattered console with a bloody body floating over it, tethered to the seat with a safety line. Gray smoke wafts slowly and several voices can be heard shouting in the background.]*

**[Myra Kellison]:** *[Coughs]* "I'm not sure if the camera is even recording at this point..."

**[Bryant Mathison]:** *[Off-camera]* "It is. You're on."

**[Kellison]:** "Thanks, Bryant. Keep it on me." *[coughs]* "As you can see, the damage to the *Truth's* bridge has been extensive, yet Admiral Beresick continues to bring the fight to the Blakist defensive flotilla—"

**[Unidentified Voice]:** "Naga dead astern! She's painting us again!"

**[Alain Beresick]:** *[Off-camera]* "Hard starboard! Now now now!"

**[Kellison]:** "The assault is disintegrating. Currently, several of the fleet vanguard have been destroyed or severely crippled, thanks to what appears to be a modified Caspar system and several WarShips." *[coughs]* "The rest of the fleet is due to arrive any minute, though each second is now a fight for survival..."

*[Several deep bangs are heard, and the bridge deck visibly shudders]*

**[Unidentified Voice]:** "We've lost our portside mains and sensor feeds, Admiral! Decks 17 through 23 not responding. The *Naga* is skimming under us..."

*[Camera rotates and focuses in on Admiral Beresick, standing amid a flickering holotank as a fire suppression mist kicks on.]*

**[Beresick]:** "Never mind that damned *Naga*. Where the hell is that *Farragut*?"

**[Kellison]:** *[Whispers, off camera]* "That's the *Righteous Justice*, which we believe to be the Blakist flagship..."

**[Beresick]:** *[Slams the side of the holotank as it flickers]* "C'mon, Zwick, where are you..."

**[Unidentified Voice]:** "Multiple jump waves detected!"

**[Beresick]:** "Are they the fleet?"

**[Unidentified Voice]:** "Confirmed! One contact identified as the *Rasalhague*! More emerging... Great Blake above, look at that..."

*[Camera zooms back, noting over three hundred jump drive bloom icons flashing around the current battle in the holotank.]*

**[Kellison]:** *[Sobbing off camera]* "We're saved!"

**[Unidentified Voice]:** "Incoming! Multiple missiles inbound!"

**[Beresick]:** "All hands, brace for impact. Guns, backtrack and fire everything we've got. Now!"

**[Unidentified Voice]:** "Justice at origin; 24 by 60 by 9. All bays firing."

*[Multiple muffled bangs off camera]*

**[Kellison]:** "Bryant, maybe we should—"

*[Loud explosion to left of frame; camera jerks spasmodically and drops, showing deckplate and debris.]*

**[Beresick]:** "Get fire team four up here now. Guns, report."

**[Unidentified Voice]:** "Admiral, *Justice* is hailing."

**[Beresick]:** "Guns, repo—oh hell. Dammit, Brandi..."

*[Camera shakes and slowly elevates, catching a glimpse of Kellison drifting slowly upward, a blood trail following the back of her head. Her left side is blackened.]*

**[Mathison]:** "Oh no. Myra? Myra!" *[A hand reaches out from under the camera, feeling for Kellison's pulse, then shakily withdraws. Brief, quiet sobbing is heard.]*

**[Mathison]:** *[Whispers.]* "For you, Myra..." *[The camera quickly turns away and finds Beresick, clutching onto the arms of his command chair, head bowed.]*

**[Beresick]:** *[Sighing heavily.]* "Put him through, Comms."

**[Gregory Zwick's voice]:** *[Transmission is scratchy]* "Surrender, Alain. I've got you dead to rights. You're no match. Not anymore." *[Beresick taps his command keyboard, looking off-camera and nodding.]*

**[Beresick]:** "So you say, Greg. You know, I knew one day we'd meet again, but never like this. Never. But I suppose now isn't the time to hash out the whys and wherefores."

**[Zwick]:** "You're right. It's not." *[Crackle]* "—an you, Alain. You and Stone's fleet won't survive. Surrender, spare your people the pain of death, knowing they've lost the fight."

**[Beresick]:** *[Taps again on keyboard]* "You should know by now, Gregory, that we'll never surrender. This is no longer a simple spat in the Order. This is the crucible of humanity—"

**[Zwick]:** "Spare me the pontifical platitudes, Alain. Very well, I'll try to make it quick."

**[Beresick]:** "And I'll try to disappoint you... Guns, fire!"

**[Unidentified Voice]:** "Admiral, the *Farragut* is riding stern to crest! Broadside imminent!"

**[Unidentified Voice]:** "Firing!"

*[Muffled explosions, sparks, then two beams come crashing down from behind. The camera spins off-axis, floating away from its*

## LATE 3078: DESTINATION TERRA



*fixed point. Several bodies can be seen as the view rotates around. A rushing sound is heard and increases in volume.]*

**[Beresick]:** "Damn you, Gregory. I guess in the end, you did win..."

*[The bridge explodes in violent decompression. Image goes static.]*

—Unaltered vid, recovered and aired 13 January 3079

**SWARMS**

>>**Excerpt commences: 16:21 (Terra GMT), 17-AUG-78<<**

**[LAS Invincible—Com Tech 21]:** "Lima Dee 12-3 *Graceland*, adjust heading to 13, 120 by 97, you're getting too close to the *Excalibur's* fire lanes...Lima Dee 23-12 *Simon Says*, increase to point 86G you're falling too far behind your screen...*Takeshi*, readjust fire lane Able 12 by four degrees. We are getting activity over Africa, possible intercept to your fire zone in two minutes."

>>**Excerpt commences: 15:34 (Terra GMT), 17-AUG-78<<**

**[Invincible—TacOfficer 3]:** "*Tide*, you're falling out of formation; what's your status?"

**[DSS Red Tide]:** "Last missile swarm took out port engine. Requesting screen launcher at grid 12-67-43 and 12-66-43."

**[Invincible—TacOfficer 3]:** "*Indomitable*, you are out of position. Come about to 278, 319 mark 23, we need an immediate screening barrage at grid 12-67-43 and 12-66-43."

**[Invincible—TacOfficer 3]:** "*Indomitable, Saïlle*, you are out of formation. Return to screening formation immediately. *Red Tide* needs anti-missile support ASAP."

**[Invincible—SensorTech 17—Intership]:** "Tactical! Confirmed inbound cap mikes on *Red Tide* are Peacemakers!"

**[DSS Red Tide]:** "*Invincible*, where is our screening support?"

**[Invincible—Actual]:** "*Indomitable*, this is *Invincible Actual*. Admiral Clay, get back in formation immediately! You are endangering the landing operation!"

**[FSS Indomitable—Actual]:** "I'm sorry, Johanna, I can't do that. The *Melissa* is exposed and in my guns. Those Blakist bastards have had her for long enough."

**[Invincible—TacOfficer 3]:** "*Tide*, go to full evasion now, eject all Droppers, scatter pattern delta seven!"

<<**Excerpt commences: 15:42 (Terra GMT)>>**

**[Invincible—TacOfficer 2]:** "Baker squadron 3, shift toward sector 243, more Drone Droppers coming out of the interface... SAR unit Charlie 4, 7 and 12, get those *Tide* life boats before the drones take them out."

**[LAS Katherine Steiner—TacOfficer]:** "This is *Katherine*, requesting fighter support. Drone ASF have blown through our fighter screen. What the hell happened to our support?"

**[Invincible—TacOfficer 2]:** "Baker Squadron 3, respond. Get in front of those interceptor DropShips and light them up. Void Actual, can you support *Katherine*?"

**[Void Actual]:** "Frostie, break right on my mark.... Mark!... *Invincible*, task Void 2-3 to help *Katherine*. 2-1 and 2-2 shifting to support Baker S3."

**[Invincible—TacOfficer 2]:** "Affirm, Mark, good shooting. >>**Excerpt commences: 15:44 (Terra GMT), 17-AUG-78<<**

**[Baker S3—Actual]:** "Void Actual, can you intercept those Drakes...*Excalibur*, roll port evasive!"

**[FSDS Avalon Knight]:** "Oh my god! *Invincible*, one of their Drakes just hit *Excalibur* mid-ship. We can see armor blow through all the way to the other side."

—Partial Transmission logs from Terra D-Day landing operation, INN, Terra, 19 August 3078

**DESTINATION: EAST**

*[Video shows a woman with brown, wavy hair standing on the tarmac of a busy airport.]*

**[Rebecca Dwyer]:** "This is Rebecca Dwyer, INN. I've just come from a theatre briefing on General Lee's DropShip. With responsibility for the Eastern theatre of operations, Lee's forces have made landings from Tokyo to Cairo."

"Lee's tactics have proven highly effective on the many fortified strongholds in her theatre."

*[The upper right corner of the video is replaced by an inset video showing six vaguely insectoid VTOLs, each carrying an assault BattleMech]*

"Using short hop DropShip assaults and even a daring air lift by Tonbo heavy lift VTOLs, Lee has targeted a number of Word-controlled Castles Brian. Her lightning strikes have managed to trap Word forces in their bunkers at Moscow and Singapore with ease, allowing her to bring in more units to secure the area before beginning to ferret out the bunkered Word."

*[The inset video shifts to an image of Andrew Redburn climbing into the cockpit of a Daishi. Rebecca Dwyer continues to speak.]*

**[Dwyer]:** "In more worrisome news, it has been more than twenty-four hours since General Redburn has been heard from. General Lee, however, remains unconcerned about the loss of contact with the Liberators as they move on Geneva."

*[Dwyer's image fades, to be replaced a shot of General Lee, in combat fatigues, leaning over a holo table.]*

**[General Lee]:** "Andy's been doing the impossible since before Victor was a twinkle in his daddy's eye; he knows what he's doing. You don't just march up to the front door of the Blakist high command and knock. He's running under EMCON and I almost pity any Blake-spawned bastard that gets in his way. Almost..."

*[The camera returns to Rebecca Dwyer. The inset image now shows the Greek Parthenon, a blue and beige Grand Titan and deep-red Black Hawk-Ku standing over the smoking wreck of a Rhino tank.]*

**[Dwyer]:** "In Athens, the reports are even better than hoped for. Taking a different tack, Lee spearheaded the attack with every covert and special ops team she could muster. Lead by the Star Seeds special infantry force and backed up by Sorenson's Sabres and mercenary forces like the Battle Corps and Chaos Irregulars, the liberation of Athens was nearly bloodless, even linking up with several Com Guard units in hiding since the failed Case White."





## LATE 3078: DESTINATION TERRA

"Surely this is a symbol for us all, the home of the original Olympics, a multi-national gathering of equals, freed by men and women from every single corner of the Inner Sphere. If mercenaries like the Battle Corps can stand side by side with Kurita's finest soldiers, then perhaps Stone's Coalition is really more than just an alliance of convenience.

"What I can tell you is that, in no uncertain terms, the liberation of Terra has well and truly begun.

"I'm Rebecca Dwyer, INN, reporting to you from Stalwart headquarters outside Sydney."

—INN special report, Terra, 19 August 3078

## HELL AT HILTON HEAD

*[Nigel Holmgren stares into camera with a look of shock and horror. Behind him the sky flashes so bright the screen loses all color for a moment and a horrible wrenching sound can be heard.]*

**[Holmgren]:** "Nigel Holmgren, reporting with Devlin Stone's strike force near Hilton Head." *[A flash and explosion causes Holmgren to jump.]* "The Word of Blake forces are repelling this attack with shocking success. They have unleashed unprecedented new weapons in their defense of the facilities, believed to be the command headquarters of Precentor Martial Cameron St. Jamais."

*[The camera moves past Holmgren and up a small muddy slope. The view crests the top and breaks onto a vision of apocalyptic horror. DropShips lay toppled and on fire. One can be seen teetering over in the air, fire ravaging its length as it smashes into the ground and shatters into huge chunks of blazing debris. The ground shakes visibly. Various BattleMechs and vehicles scramble about trying to shoot at targets farther in the distance and look in total disarray.]*

**[Holmgren, off-camera]:** "The Word of Blake's forces have apparently made considerable defensive modifications beyond what Stone's intel briefing indicated. Some of the DropShips—Good Lord!" *[Another brilliant flash of light blinds the screen for a second.]* "What the hell was that!? What are they firing?" *[The camera refocuses on Holmgren as he ducks behind the crest of the hill.]* "Ryan, let's pull back a bit for safety's sake..."

*[The camera blinks off, though audio can still be heard as sounds of footsteps scuffle mix with light panting.]*

**[Holmgren]:** *[Camera image returns. Holmgren appears to be out of breath.]* "The landing at Hilton Head seems to be suffering catastrophic counterattack, and we may have to abandon this broadcast without warning—Wait, there's a command van now..."

*[The camera shakes and bounces as it turns. Flashes of uniformed people running by can be seen and loud explosions can be heard. A Mobile Command Vehicle slews into view, flanked by an Atlas II painted in a skeletal design.]*

**[Holmgren]:** *[Small gasp off-camera.]* "Devlin Stone himself..."

**[Voice from Atlas II external speaker]:** "All units, effect Omega-Bravo withdrawal. We're moving west. Captain Frost,

round up our footsloggers and give them a lift, including the newsie." *[The Atlas II points at Holmgren and the camera.]* "Mount up, Holmgren. Let's move it!"

—INN Broadcast filed from Hilton Head, 19 August 3078

## CALLING CAIRO

*[Video shows reporter standing behind an Ontos tank. Artillery is heard in the distance.]*

**[McPhearson]:** "This is Shane McPhearson, reporting from Kanrei Minamoto's headquarters south of Cairo on the Nile River. Currently, Coalition forces are regrouping after a disastrous first assault on ROM Headquarters deep within in the Blakist-controlled city. Unconfirmed reports placed a number of Light of Mankind SpecOps units rounding out the enemy based out of the Castle Brian fortress, along with the Thirty-sixth Division and several battalions of TerraSec armor and infantry troops." *[A ripple of artillery shells tears the sky overhead. McPhearson barely twitches.]*

"After maneuvering into position, the famed Kell Hound regiments led the assault on Cairo. Coalition command believed the enemy was holed up in the Castle Brian located within the city. The Hounds' two demi-regiments moved towards their objective under the cover of a massive artillery barrage. The Second Dieron moved in support, while Stone's Revenants and the First Sword of Light protected the flanks against any counteroffensive maneuvers.

"Meeting no resistance in the first few kilometers, the Hounds pressed forward into Cairo's southern business district. Upon reaching the bank of the Nile, the surrounding high-rise buildings exploded in sequential detonations, obliterating several city blocks. As the smoke and debris cloud cleared, only a few 'Mechs emerged from where the Hounds and Regulars had disappeared. *[Pause.]*

"Of the nearly 75 BattleMech units progressing in the forward area, less than twenty returned to Coalition lines and even those were heavily damaged. The Kanrei has repositioned the Coalition force into a defensive posture as rescue operations continue. Several more Hounds and Regulars soldiers have been found and recovered in the process, though strangely there has been no report of any civilian casualties. Clearly, the Word of Blake was waiting for us—and Cairo will not be the easy desert oasis to plunder as originally thought."

—ISAP field report, Cairo, Terra, 20 August 3078

## TOKYO SECURED

(21 August 3078)

Terra [VOTD] — Tokyo and the surrounding area between the Kasumigaura Lake and the foothills of Mount Kawanori have been secured, according to the Tokyo task force commander, *Tai-shu Isoroku Kurita*.

The Twenty-third Arcturan have begun taking up positions on the slopes of Mount Kokushigatake outside the Tokyo Castle

## LATE 3078: DESTINATION TERRA

Brian complex. Early reports indicate limited resistance from the complex, largely from automated fixed defenses. The facility appears to be locked down, as no movement, transmissions, or other activity has been detected.

The First Crucis Lancers have reported no significant opposition north of Tokyo, while the Second Genyosha considers the area around Kyoto to likewise contain no Blakist formations. If these assessments are accurate, the cracking of the Castle Brian can begin in earnest within just a few days.

Eerily, the streets are empty and quiet and the population looks upon the Arcturan 'Mechs and tanks in its streets with distrust in their eyes. The Arcturans have set up their basecamp outside of Tokyo proper, and indications are that the other units assigned to the island will follow suit.

It is clear from moving among the troops that the decided lack of action so far is frustrating those who have been eager to eradicate all signs of the Word of Blake. While this will be impossible to verify until the Castle is breached, it does appear that the Japanese island will be under Coalition control with barely a shot fired.

Still the conquest is not without casualties. Two Arcturan infantrymen have died from complications due to food poisoning just yesterday, and several more are sick, prompting the *Tai-shu* to forbid all troops from taking food from street vendors. We can only hope that this is the worst of it, as the memories of Quentin are fresh in the minds of many.

## CALAMITY AT SYDNEY

(21 August 3078—Filed 1 September 3078)

Terra (Hartley Vale, Australia) [VOTD]—*[Clouds of dust bellow into the air as a battered Demolisher Tank wearing the tartan of the Northwind Highlanders struggles to move its bulk into the shade beneath a makeshift repair station. Its shredded tread slaps the ground with each rotation while its sputtering engine belches black smoke into the dry air. A group of grease-covered techs wait beneath the station's canopy, drinking cool green liquid from empty shell casings.]*

**[Orson Tanaka]:** "It's day three of the campaign to liberate Sydney but General Belle Lee's forces appear no closer to victory now than they were when they landed."

*[The camera pans left, a gust of dust-laden wind tussling Tanaka's unruly mop of hair, turning it a sickly yellow. He coughs once, brushes off his khakis, then removes his dirty goggles, revealing two clean spots around his sleep-deprived eyes.]*

**[Tanaka]:** "Two days ago, Coalition forces under General Lee came under intense fire as they attempted landings in and around Sydney, Southerland, Campbelltown and Wollongong. Almost half the task force crashed, scattering troops and ships across nearly 100km of territory west of the Wild Dog Mountains. Adding to their woes, the Word of Blake's Seventh Division materialized from hidden fortifications within the Jenolan

## BLOODY MOON RISING

*[Vid-screen shows a reporter wearing a dusty armored environmental combat suit. Surrounding him is a debris-scattered room with scorch marks and large caliber bullet holes visible in the walls.]*

**[Orloff]:** "I am standing here in the former TerraSec command center on Luna just outside the capital of Luna City. As you see behind me, the control center suffered severe damage in the final battle.

"Roughly four days ago, Coalition forces under the command of Captain Marcel Webb made a combat drop directly on this TerraSec base to gain control of the command and control center that posed a clear threat to General Stone's invasion force. The Luna assault force included mostly battle armor troopers from DCMS DEST squads, the Star Seeds, and Elemental Stars from Jade Falcon's Alpha and Clan Wolf's Delta Galaxies. As the force entered Luna's orbit for insertion, several TerraSec aerospace fighters attempted an interdiction. Our fighter escorts, combined with the firepower of our assault DropShips, forced the TerraSec fighters to retreat after a brief engagement.

"The battle armor units were dropped at the four cardinal points around the base. Primary assault belonged to Star Seeds, Falcons, and Wolves to draw attention away from the DEST teams, tasked with deactivating and securing the command center's defensive systems. From the outset, the battle proved extraordinarily arduous for Coalition forces. Ground defenses included manned turreted energy weapons, numerous missile launchers, and prepared defensive locations. Undaunted, the Coalition forces executed a textbook example of assaulting prepared positions. Soon, troopers breached the first of two defensive perimeters and were then promptly counterattacked by TerraSec reinforcements.

"The Falcon and Wolf Elementals then overran the primary defensive line as the DEST force breached the base. That action caused the entire defensive network to collapse, forcing the Blakist defenders to withdraw into the base. After a brutal seven days of "armed hide-and-seek," the base finally fell after a furious firefight near the central control room. Both sides suffered tremendous casualties; nearly half of the Coalition's troopers are dead and another 15 percent wounded. Of the TerraSec defenders, only a few squads remained and have been taken prisoner.

"For INN, this is Yves Orloff, reporting from inside TerraSec's Luna command center."

—Video journal filed 22 August 3078

cave system. They caught the Eighth Dieron Regulars as they struggled to regroup near the town of Hartley, obliterating them. Those lucky few who survived the carnage were executed in cold blood by Blakist hit squads."

*[Overhead, a flight of Blakist aerospace fighters scream past, spitting flames at a nearby M.A.S.H. unit. A one-armed JagerMech,*



## LATE 3078: DESTINATION TERRA

wearing more patch primer than paint, steps out from under camouflaged netting and sprays rounds from its remaining arm at the retreating craft. Hot shell casings clang to the ground in droves. The screams of the wounded fill the air. Tanaka barely flinches.]

**[Tanaka]:** "While losses have been horrendous, some good has come of these misdrops. We know now from reports of our scattered units that the entire Wild Dog Mountain Range is riddled with caves and fortifications designed to support the reported Castle Brian at Lake Burrangorang and Sydney.

"We also know that the Seventh and Twenty-sixth Word of Blake Divisions are defending the area. Telemetry suggests the Blakists have established an airbase somewhere to the south, possibly on the Antarctic continent. There, they stage constant harassment raids. In light of these developments, General Lee and her aides are developing a new plan to take the Castle Brian and Sekkaris MechWorks near Botany Bay.

**[Tanaka]:** "Yet in a universe where data streams are as varied as the opinions that spawn them..."

*[The camera pans out over the cleft of the ridge and surveys the scene of utter devastation. Fires rage across what once was a small town. Tanks, BattleMechs and battle armor lay crushed, broken and burning amid craters and stumps of ruined trees. Highway Thirty-two, which stretches through Mount Victoria's nearby pass, lays choked with rubble, debris and the charred bodies of the men and women. A ragged group of 'Mechs and troops tread wearily through the remains of their comrades on the march up the pass towards the fighting beyond.]*

**[Tanaka]:** "An entire regiment is gone..."

*[The camera swings back towards Orson who stands staring off into the distance, a haunted, haggard expression on his face.]*

**[Tanaka]:** "...for the want of information."

## RIO GOES BLACK

(9 September 3078)

Terra [INN] – Rio de Janeiro, expansive jewel of the South American continent. It's also the latest victorious battleground for Stone's Coalition.

Initially, the landings in mid-August went well. The magnetic and decisive Marshal Jon Davion led his forces—the Iron Guard, the Fifth Crucis Lancers, and the Twentieth Marik Militia—in a dramatic capture of the city's biggest manufacturing quadrant through well-coordinated hot drops and beachhead maneuvers. With his success, the Coalition managed to seize the three biggest manufacturing facilities in the Amazon region and the main TerraSec supply depot and staging grounds at Forte Santa Cruz.

However, things got ugly fast when Marshal Davion and his troops advanced on the SDS Command Fortress at Governador Island. There, they were stopped cold by a system of breastworks and interlaced defenses that stymied all assaults.

Marshal Davion settled in for a siege, hammering the fortress with constant artillery, aerospace, and DropShip barrage. After

three weeks of intense bombardment and constant study, an elite battle armor strike team managed to penetrate the Fortress' subterranean access point and destroyed the large power farm that fueled the facility. With the complete meltdown of its three nuclear facilities, the control center of the entire Terran SDS defense network cascaded into failure. And suddenly, the Coalition had access to the skies.

## THE FALL OF THE WORD

## WE WILL NOT STRIKE TERRA

*[Screen shows a young reporter standing near the back of a large DropShip wardroom. At the head of the room is General Belle Lee, talking in earnest into a communications console. The rest of the room is empty. The camera zooms in on Lee.]*

**[Lindy Sung]:** "A short briefing had only recently broken up when we noticed an intense conversation between General Lee and who appears to be Khan Aletha Kabrinski, commanding the *Rasalhague* in orbit over Terra. We're going to listen in, as undoubtedly this is important."

**[General Belle Lee]:** "You what?"

**[Khan Aletha Kabrinski]:** "I said I will not do such a thing. Nor will any vessel under Ghost Bear command."

**[Lee]:** "And why not, Khan?"

**[Kabrinski]:** "It is a matter of honor. I cannot allow it."

**[Lee]:** "Oh come on! You weren't so picky about honor when the *Blood Lust* got raped by the *Rays of Enlightenment*..."

**[Kabrinski]:** "This is different. We will not fire on the sacred crèche of Terra."

**[Lee]:** "Is this your way of telling us 'Well thank you very much for the ride, now go to Hell?'" *[Visibly upset.]*

**[Kabrinski]:** *[Unfazed]* "There is no need for profanities, General."

**[Lee]:** "Isn't there? Half our unit dies here if you're not gonna drop some lightning on that airbase. They will be torn apart fighting the same enemy you swore to exterminate!"

**[Kabrinski]:** "Then so be it. I will support you in any other way I can."

**[Lee]:** "Yeah, you're not down there..."

**[Kabrinski]:** "You know full well that our ground forces are not allowed to land on Terra, General. It is not our fault..."

**[Lee]:** "Oh shut up..." *[Slaps a wall panel.]* "Comms! Connect me to Stone!"

**[Comms]:** "HQ is not responding, sir."

**[Lee]:** "Get Redburn on the line. Let's see what he can do about our orbital support. Bloody Clanners!"

Terra [INN]—Report filed by INN reporter Lindy Sung, Terra, 19 August 3078

## LATE 3078: DESTINATION TERRA

**BEACHHEADS SECURED**

(27 August 3078)

Terra [INN]: The battle for Terra has begun. Coalition forces have managed to make landings on the planet's surface and begin their assault on several vital Word of Blake positions.

Resistance from entrenched forces has been inconsistent. Several allied landing sites have encountered bitter and determined resistance while others have been claimed with little to no combat. The defensive strategy of the Word of Blake remains a mystery even now. However, it is clear that Devlin Stone's Coalition has selected both strategic and historic sites among their initial landing areas. Observers suggest that the selection of these historical sites is intended to deny the Word of Blake a "scorched earth" option that could be used to barter for an eventual escape.

In Athens, a largely uncontested landing by Coalition forces has secured many of the areas' historical landmarks. Minor opposition has been quelled and allied forces now firmly control the region. The task now turns to spreading out in an attempt to unearth and join with any surviving Com Guards or resistance cells operating within the area.

In Moscow, Duke Robert Steiner's task force reports another successful landing. Token Blakist resistance proved to be of little concern to the Coalition as they established a major foothold in Eastern Europe. The securing of General Aleksandr Kerensky's birthplace is viewed as more of a symbolic than tactical victory. However, its buoyant effect on the morale of the troops under Steiner's command is obvious.

Allied forces have also claimed a major installation in the Dallas/Fort Worth region. While initial resistance was heavy, the invasion force was able to gain the advantage and eventually secure the facility. Dating back to the days of the original Star League, the Bowie factory complex may serve as a key strategic holding as the invasion force prepares to move deeper into Blakist-held territory.

As the ground war begins, it is clear that Devlin Stone has succeeded in establishing beachheads on every major continent. In the days that follow, these key landing sites will transform into vital bases of operation. Striking from these secured landing zones, Stone's armies will be able to land supplies and reinforcements as the invasion progresses to its next phase.

Perhaps the most surprising development of the invasion to date has been the reaction by native Terran citizens. Terran citizens seem clearly and firmly sided with the Word of Blake. Reactions to allied forces have ranged from fear to armed insurgency. As Stone's forces move ahead they will have to consider the very real possibility that the citizens of Terra will actively engage in a guerrilla war designed to aid the Word of Blake. Devlin Stone himself attempted to reassure the local populace that "unless the people of Terra mark themselves as

combatants by taking up arms against us, no military action will be taken against them, their families, or their property."

**SCOURING THE NILE**

(1 September 3078)

[Kanrei Kiyomori Minamoto's face fills the video image.]

**[Minamoto]:** "Last night, at 2300 local, two companies of the Second Kell Hounds, supported by a regiment of mixed conventional forces, entered the city northwest of Jabal Umm Alda. Overflight reconnaissance data showed a single Level III protecting access to the interior. Our flanking force instead found that the Level III also had significant artillery support. Losses were heavy for our side, nearly sixty percent destroyed or combat ineffective.

"We currently estimate that the Hounds and support forces managed to inflict at least forty percent damage in return, but how much of that is unrecoverable is unknown at this time. The Hounds lost another lance of machines during the retreat to Adabiya from VTOL harassing fire."

[Minamoto's face is replaced with a contoured map image of the Nile delta area. Units are marked in various colors. A large gray cloud slowly moves across the map towards the upper right corner as Minamoto's voice is heard.]

**[Minamoto]:** "During the Kell Hound retreat, the Word of Blake pushed into our main line to the south of our current position with a battery of massed artillery fire. This artillery attack used warheads of both smoke and a chemical compound. Initial casualties were less than one hundred, as most troops have been on NBC alert. However, analysts have informed us that the chemical smoke is expanding and drifting across the delta. The civilian death toll will be high. Extremely high. Current estimate is three-quarters of a million, possibly upwards of two."

[Image returns to Minamoto, whose head is bowed in exasperation.]

**[Minamoto]:** "We have begun notifying civilians in the path of the cloud and set up several emergency treatment centers. No one leaves without a suit and a check from an approved NBC-trained trooper. Those who have extra suits, filters, masks, etc may donate them to your unit's medical corps, who are distributing what we can to civilian emergency services personnel."

[Minamoto looks at the camera, eyes blazing.]

**[Minamoto]:** "Remain vigilant, warriors. The Word may use this as a pretext for another counterattack. Direct any questions to your commanding officers."

**ST. JAMAIS ESCAPES**

[Nigel Holmgren stands in front of a smoldering Toyama.]

**[Holmgren]:** "This is Nigel Holmgren reporting from just north of Little Rock in North America, where—just a few hours ago—there was a major engagement between Word of Blake



## LATE 3078: DESTINATION TERRA

Precentor Martial Cameron St. Jamais and Commanding General Devlin Stone's armies..."

*[File footage of the battle from various gun cameras roll as Holmgren provides voiceover.]*

**[Holmgren]:** "On 7 September, St. Jamais launched a surprise attack that caught Stone completely unprepared. The attack commenced shortly after the nuclear annihilation of the Dallas-Fort Worth megalopolis, beginning with a major air strike from Word of Blake DropShips, aerospace fighters, and orbital strikes against the allies' lines. Using the resultant fire and chaos as cover, the zealots' white BattleMechs erupted from the oily black smoke and the Coalition's line began to waver.

"A number of units appeared to be retreating until the appearance of General Stone in his *Atlas II*. He rallied his troops and led a counterattack that forced the Word into a grudging retreat, breaking contact in the hills just north of our location.

"Reportedly, elements of Stone's army believed the Blakist line was broken and rushed to re-engage—only to run headlong into the Word's rearguard. Without support, they suffered staggering losses; only half of those allied units managed to return to the line.

"Early reports indicate that St. Jamais has split his force into three separate, smaller commands. One force has moved back east, another angled southwestward. The larger group, led by what appears to be St. Jamais' own *Awesome*, has moved northwest, in the direction of the Kansas City. Would the Coalition pursue?"

*[Image changes to the interior of a command vehicle. Stone is standing near a small holotank, examining a detailed map. He appears exhausted.]*

**[Holmgren]:** "Thank you, General, for giving us a moment of your time..."

**[Stone]:** "Fire away, Mr. Holmgren."

**[Holmgren]:** "What is your impression of our forces after what appeared to be a disaster in the making?"

**[Stone]:** "Simply put? We were caught with our pants down. St. Jamais sucker-punched us. While we were all looking back towards Dallas and what happened there, we didn't consider that was a prelude to a major offensive."

**[Holmgren]:** "Why did you not follow and attempt to re-engage?"

**[Stone]:** "Although we forced St. Jamais to withdraw, we didn't defeat him. He chose this place to do battle. However, our troops are exhausted. After what they just witnessed in Dallas and then here on these bloody fields, morale and confidence is badly shaken. I chose not to follow St. Jamais in order to rest our troops, re-supply, and make repairs as needed. Don't worry, Mr. Holmgren, we'll be after him soon enough." *[Stone leans forward, his eyes aglow.]* "Mark my words: I will see Precentor Martial St. Jamais captured...or dead."

—Report filed 8 September 3078

**PUSHING THROUGH BURRAGORANG**

(13 September 3078)

Burraborang [INN] — After a grueling month-long punch through the Wild Dog Mountains, Stone's forces were finally able to threaten the imposing Burraborang Castle Brian. There were tunnel networks in the mountains; though supported by this Castle Brian, they were not nearly as extensive or protected, but the Word of Blake used them to great effect while the Coalition recovered and moved through the natural barrier.

Things only got tougher when they got within striking range of the Burraborang forces. General Lee thought she had pulled off quite a coup when she was able to get infiltrators disguised as Blakists inside the Castle Brian. Their status was good until somehow the Robes uncovered them. What occurred to those brave souls is still jarring to recall; suffice it to say they had slow and unpleasant deaths. With guile having failed, the Coalition then had to rely upon brute force.

The first clashes were distractions as Coalition forces proceeded to hit the exposed artillery and anti-air emplacements that helped protect the mountain complex. They then proceeded to probe the various entrances, looking for a primary access point. Too often the Blakists were using small exits, some not even big enough to fit a 'Mech, to sally forth. Attempting to oust the Robes through those would take forever and cost too many lives. General Lee's army caught a break as they surprised a raiding party sneaking out of a lower access tunnel. Cutting off this company-sized unit, Captain Edward Smith's *Xanthos* charged into the middle of the formation, absorbing a tremendous pounding from the Blakists as he and his lance mates took down half of their opponents. In short order, the survivors surrendered as more Coalition troops arrived.

"Based on the information extracted from the prisoners, General Lee proceeded to pour a battalion of mixed forces into Kedumba, battling their way into what appeared to be a suburban parking garage which hid a major access point into the Castle Brian. As they pushed their way into the facility, Stone's troops also discovered another entrance hidden just below the surface of Lake Burraborang. They swiftly punched through the lake entryway, allowing their forces to meet up inside the Castle Brian.

Once the Coalition was able to take a huge section of the facility, the proceeding push to take the fortress was only a matter of time. Without a secure base of operations to defend inside, organized Blakist resistance fell on 10 September. The past few days have been spent securing against holdouts, but Stone's forces now have a base of operations to continue the Sydney operation.

**RIO CAPTURED; DALLAS BURNS**

(filed 15 September 3078)

Terra [INN] — Preliminary reports from the Liberation of Terra are mixed in the Americas. The South American city Rio de Janeiro has fallen to forces led by Marshal Jon Davion. Much

## LATE 3078: DESTINATION TERRA



of the city fell quickly and with little damage on the first days of its liberation, with three major military factories and a TerraSec supply depot seized by 21 August. The depot and factories are already bolstering Coalition forces across Terra. This assault then stalled outside the SDS command fortress. After some losses in probing attacks, Marshal Davion turned to his engineers to use the ancient tactic for besieging fortresses: mining. The local Comedor de Montanhas engineering company had several large tunnel boring machines in its warehouses, victims of ruined export deals, and these magnificent examples of Terran engineering were put to use. In just twelve days of determined burrowing while Marshal Davion shelled the complex infantry and battle armor of the Fifth Crucis and Twentieth Marik Militia were able to storm the fortress from below and overwhelm the surprised defenders.

Such success was not shared in North America because the Word of Blake was willing to resort to some of the cruelest of mankind's weapons. After a tactical retreat from a probe on Hilton Head Island, Stone was rallying troops at the secure Dallas-Fort Worth staging area when Blakist defenders attacked the cities—notionally their own cities—with nuclear weapons. It has been reported that the Marlette Crucis March Militia and Hansen's Roughriders suffered heavy losses, but those military losses pale compared to local civilian casualties. As moderate-yield weapons of several hundred kilotons, the half-dozen warheads were only aimed at the general area of the twin cities, as if the Word did not know where a two-week old enemy beachhead was on a planet with such a dense data network.

The firestorm from the weapons spread into a general wildfire across the very fertile farmlands south of the cities, creating a vision of literally scorched earth for thousands of square kilometers. The worst damage, though, is not visible. The six nuclear weapons were cobalt-jacketed, salting the earth with intense fallout that will last for decades rather than the normal weeks. There was no military purpose to using these weapons, as modern military units have the protective equipment and sealed life support that will largely protect them from such weapons, only making operations in the Dallas-Fort Worth region inconvenient. The same cannot be said for the civilians, who are likely to die by the millions.

### SANDHURST FALLS

(21 September 3078)

Geneva, Terra [INN] — More than a month after the initial landings on Terra, the Blakist military command center at Sandhurst is at last in Coalition hands. A military training facility for over a thousand years, Sandhurst has been the focus of struggles between Alys Rousset-Marik's task force and what appear to be elements of a dozen different Blakist formations. With the London Metropolitan District a scant dozen kilometers away, establishing solid control of the region has proved

troublesome, with numerous terrorist incidents sapping morale. The complex itself seems to be of only peripheral interest to the Word defenders, who may have viewed it as too exposed to be a good base of operations and who instead operated from scattered locales across the British Isles, including Salisbury Plain, the Welsh Mountains and the Pennines. This scattered approach forced Duchess Marik to split her forces, which in turn made them more vulnerable to the hit-and-fade tactics so familiar to the Free Worlds guerrilla leader. The Blakist tactic also obfuscated their numbers and it seems likely that they used the confusion to make their forces seem more substantial, a shell game played with 100-ton behemoths and particle weapons.

However, now that resistance appears to have ended in the British Isles, there seems to be friction among the command staff. On the day Sandhurst fell to the Coalition, 17 September, Precentor Martial Steiner-Davion and Duchess Rousset-Marik were witnessed to be engaged in a heated debate. The nature of the dispute is unknown, but may have focused on the difficulties faced during the operation and the alleged intelligence failings regarding Blakist forces in the isles.

With Sandhurst and environs secure, attention in Western Europe shifted to General Redburn's siege of Geneva, the former Hegemony political and administrative capital, defended by the Word's Fourth Division. With his Liberators dug in around La Praille in the South, the spaceport in the north and Châtelaine in the West, the task force appeared to have a stranglehold on the city. Aggressive patrolling from the spaceport toward Lac Léman (Lake Geneva) gathered vital intelligence on the Blakist forces in and around the Parc de l'Ariana, paving the way for a final assault.

However, before the attack could be mounted a hitherto unidentified Blakist formation (which appears to have gathered near Amsterdam) struck the rear of the Coalition troops guarding the spaceport and broke through their line to join up with the remnants of the Fourth Division. Exploiting their momentum, the Word forces abandoned Geneva and began a fighting withdrawal along the northern shores of Lac Léman, staging rearguard actions at Morges, Lausanne, and Vevey before escaping up the Rhone Valley. Stone's Liberators and other elements of the task force remain in close pursuit, though the destination of the Blakist forces remains unclear.

### MAINLAND PURSUIT

(1 October 3078)

Terra (Bratislava) [INN] — As dawn breaks, we can see the wreckage of last night's titanic struggle between the Word's Fourth Division and Coalition troops under the command of General Andrew Redburn. The dozen days since their breakout from Geneva have seen the Fourth battle though the Alps, using the tortuous terrain along their 800-kilometer route march to good advantage. Coalition hunters repeatedly found themselves ambushed by determined Word troops who sought

**LATE 3078: DESTINATION TERRA**

to both bloody and delay them. Twice, the Coalition force thought they had the Fourth cornered, only for the Blakists to wriggle out of the traps.

To the surprise of Coalition commanders, the Word's forces avoided major population centers, skirting Innsbruck and Salzburg on their journey eastwards. Only as they reached the Eastern Alps did this change as the Blakist force veered south towards Graz, where they were turned aside by the Fifth Lyran Guard and the Sixth Com Guard Army. Bracketed by Coalition forces, the Fourth forced passage eastwards, skirting south of Vienna and the Neusiedler See before finding themselves once more in a Coalition pincer northwest of Győr. Rather than fight their way through, the Blakists turned north, racing the Coalition to the Danube bridges at Bratislava, where they quickly established defensive perimeters and prepared to face Coalition troops.

A stand-up fight may not have been their intention; engineers worked diligently to bring down the bridges as night approached, and though only two of the five crossing points had been closed by the time the Coalition arrived, all but the smallest had been mined and rigged for demolition. Only the valiant work by engineers from the Sixth Com Guard and the Stewart Home Guard—all while under heavy fire—ensured the bridges remained up.

Blakist resistance focused on Bratislavsky Hrad (Bratislava Castle) and the Grassalkovich Palace. Situated on a bluff overlooking the Danube, the former was a natural fortress and provided an excellent platform for Word snipers and artillery to harass the crossing points. Taking the castle was a key objective, assigned to Stone's Liberators, while the Palace assault was under the overall command of David McKinnon and the Fox's Teeth. Other Coalition forces were tasked with securing the crossings and preventing any breakout by the Fourth.

An old city, Bratislava wasn't ideally suited for 'Mech and armor combat and many of the clashes during that bloody night were close-order infantry engagements, with grenades, bayonets and automatic rifles being the most practical tools for clearing city blocks. The castle fell around 0300 hours, local time—after five hours of bloody fighting.

Two hours later resistance in and around the palace ended, though sporadic fighting continues across Bratislava, particularly in the Old City. Exact casualty figures are not yet known but are expected to be significant on both sides. It appears that most of the Fourth perished in the city, with only a single Level III fighting their way clear and fleeing eastward towards Budapest.

**BREAKING KRUPPS**

(10 October 3078)

Terra (Budapest) [INN] — When the Coalition troops under Andrew Redburn pursued the last remnants of the Word's Fourth Division to Budapest, they expected to do little more than administer a coup-de-grace. What they found was a fight that made the butchery of Bratislava pale by comparison.

The HQ of Krupps Armaments, Budapest may always have been the Fourth's objective, but whether they planned to rearm here or whether it was a rallying point for Blakist troops may never be known. The presence of part of the Sixteenth Militia and significant elements of TerraSec were an unpleasant discovery, albeit one well within the Coalition force's ability to handle. Breaching the Blakist lines and forcing entry to the Krupps facility proved challenging, with the dogged defense of the Sixteenth and TerraSec troops blunting the probes, and a series of miscommunications regarding the goal and timing of the attacks (particularly between the Home Guard and Fifth Lyran Guards) hampering efforts to focus the assaults. It wasn't until late in the evening of 3 October that their line was breached by a surprise attack by the Fox's Teeth punching through a weak flank.

Success soon turned into a desperate struggle as the Blakists abandoned their outer defenses and collapsed into a compact ring around Krupps, part of their force pointing outward to hold off Redburn's Coalition troops, the remainder facing inwards to crush McKinnon's force. It became a race for both sides—for the Blakists to eliminate the Fox's Teeth who threatened their rear, and for the Coalition to relieve the pressure before the Davion unit was crushed. Both sides displayed considerable tenacity and ferocity, and though the casualties mounted neither were dislodged from their positions. Ammunition became a critical issue for both the Word and the Fox's Teeth, with melee combat and energy weapons becoming the primary weapons in their close-order sparring.

A daring combat drop by the remainder of the Sixteenth Militia and elements of the Twenty-first finally broke the stalemate in the early hours of 5 October, forcing Redburn's troops away from Krupps and giving the Blakists a chance to rearm. The Fox's Teeth had no such respite and soon found themselves under intense assault by infantry trained in anti-Mech operations, believed to be ROM Special Forces troops. McKinnon's force sustained serious damage but managed to repel the assault.

With the Blakists reinforced, only extreme measures could save the encircled Davion troops. On the morning of 10 October, General Redburn was able to break the siege using massed artillery and fire from hovering DropShips. McKinnon's bedraggled command emerged as heroes, having held out for eight days and denying the Blakists use of the facility. Few Word troops survived the carnage; those that remained fled eastward toward Russia. Using his authority with the Coalition—and over the objections of the surviving Krupps management—Redburn's troops stripped the complex of materials to allow them to repair and rearm, leading to speculation that the task force will be redeployed, either elsewhere in the Balkans or to Cairo. Calls by the city council to discuss the collateral damage caused by the assault, in particular from the exhaust of low-flying DropShips, have thus far not been answered by the Coalition.

## LATE 3078: DESTINATION TERRA

**BLOODY SUNDAY**

(11 October 3078)

*[A bedraggled Orson Tanaka stands off to one side of the camera, showing the massive sprawl of Sydney, which sports a few smoking buildings and rubble piles.]*

**[Tanaka]:** "As you can see, Coalition forces under the command of General Lee have moved to the outskirts of Sydney, fighting its way through the Wild Dog Mountains. Obtaining this real estate did not come cheap, with thousands of wounded and much equipment lost. Most of the fighting is currently occurring there."

*[He points to the middle of Botany Bay, then Sydney Harbor.]*

**[Tanaka]:** "And over there. You probably can't see it, can you? Don't bother squinting; the fighting is actually going on a thousand meters below the surface. Once the two access tunnels to the underwater facility are taken, the General expects to encircle the city and take it from all sides. Viewers may be wondering why forces here, in the foothills of the mountains, aren't attacking in earnest. Well, the fight to take the mountains took a heavy toll. Even if she had not lost a single soul through these passes, it is unlikely Lee would have enough forces to take Sydney. And the logistics trail over the mountains is too long and exposed for our entire force."

*[He points to an area still covered in lingering smoke. Through the black tendrils, a vast expanse of ferrocrete can be seen.]*

**[Tanaka]:** "You may notice that one area of Sydney there off the coast of Botany Bay has been heavily hit. The Sydney spaceport has been the primary target of Coalition artillery attacks and has been rendered inoperative for either side. Our positions up here experienced some fighter attacks when our forces first began to place their artillery units here, however you can see the skies are now clear."

*[The camera slowly pans up and then around the horizon. A few craft are seen circling high above. A VTOL in Stone's Lament colors streaks by as the camera returns to Orson.]*

**[Tanaka]:** "Between air support and anti-air emplacements, the Blakists have ceased their sorties out of somewhere in Antarctica against our position. They still contend for control of the skies but stay above the mountains, out of reach of our Partisans."

*[File footage of a lance of Partisan tanks firing, bringing down attacking fighters.]*

**[Tanaka]:** "What is next for the Coalition forces? Well, the exact plans aren't public, of course, but the basic points remain obvious. They must take the two entrances to the city under the two bays. The Sekkaris 'Mech manufacturing facility must be captured, though it is a hardened target and not likely to go easy. Perhaps most difficult is a populace that is not welcoming us. It's one thing to kill the Word of Blake troops, but quite another to find a way to deal with people who believe they are protecting their homes."

## SINGAPORE ON FIRE



(19 October 3078)

TERRA [INN] – The ancient city of Singapore was violently wracked in the early morning hours as several explosions erupted in Bukit Timah quarter, near the center of the massive Castle Brian complex that occupies much of the island. The surface explosion has been confirmed as a nuclear explosion, similar to that of a small tactical weapon. Authorities are assuming the underground explosions are of similar design.

Anonymous officials within the Fifth Free Worlds Guards suspect the explosions are the result of a self-destruct sequence triggered by the Word of Blake. While it is unknown exactly why the Blakists would set off the complex after having just recaptured it only half a day ago, the fact remains that the surviving Coalition forces managed to reach the mainland before the explosions occurred.

Preliminary estimates put the death toll over a million and it is expected to continue climbing as the fires rage unchecked through the city. Emergency crews and relief efforts are underway and will hopefully quell the raging fires and begin decontamination protocols.

There has been no sign of Word of Blake forces in the area and it is assumed the forces that recaptured the facility have perished in the explosions.

*[Camera zooms in on the reporter's face.]*

**[Tanaka]:** "Somehow, some way, we will prevail."

**CAIRO FRONT STALLS**

(12 November 3078)

Terra [INN] – Tensions are high here in the ancient city on the Nile River, where Coalition forces continue to be stymied by the immense defenses thrown up by the Word of Blake. Although the allies have suffered their share of casualties, the civilian population still here continues to suffer the most. Unconfirmed estimates put the death toll near one million; most of this is due to the heavy biological and chemical attacks conducted about a month ago by a Blakist counteroffensive around Port Said. The fertile land of the Nile delta from here to the shores of the Mediterranean is quite possibly poisoned irrevocably.

To say Kanrei Minamoto's patience is worn thin would be an understatement. What was believed to be an easy objective has turned into one of the Coalition's biggest bottlenecks. Stone and his commanders believed ROM had abandoned the Castle Brian here for its headquarters on Mars but did not expect the level of defensive layers in and around the Nile delta. Most of the land between the two opposing forces lies in ruins. The fighting is more of a "turf war", with opponents vying for one block after another. With much of the city a maze of ambush points, booby traps, and other surprises, the Coalition force has turned its





## LATE 3078: DESTINATION TERRA

tactics from an offensive siege into a delaying action. As no units are currently able to reinforce the *Kanrei's* task force, assaulting the Castle Brian with overwhelming force is not a viable option. Additionally, we've received word that General Lee has issued a moratorium on orbital strikes due to critical fleet losses.

At the beginning of November—over a month after the initial assault—we received reinforcements from General Redburn and his army from the European front, though it may have been too late. A major storm system is moving in, bringing unseasonably heavy rains that could soak the Lake Victoria region farther south for over a week. According to local experts, this will have a direct effect on the Nile in the next few days, with the river expected to rise to record levels and quite possibly overflow the ancient walls and diversion networks. If such flooding occurs, what's left of Cairo will become a quagmire of mud, impassable roads, quicksand, and flash floods.

Rumors among General Redburn's troops have indicated that some form of departure is imminent; Colonel Akira Brahe of the Kell Hounds hinted that the General and the *Kanrei* have been in discussions regarding ROM's main facility on Koryo, Mars. As I understand it, currently the *Kanrei* is the only commander on Terra with enough troops to spare for such an endeavor.

If such a plan occurs, it will reduce manpower here to critical levels, leaving too few to forge an assault and barely enough to hold the line.

Unless the *Kanrei* can find a way to mitigate these latest problems, Cairo may well be the last Word holdout of this war.

## NO ESCAPE

*[Image reveals Nigel Holmgren standing to the right of a detached and smoldering BattleMech arm.]*

**[Holmgren]:** "This is Nigel Holmgren reporting from the scene where a few hours ago, Word of Blake Precentor Martial Cameron St. Jamais was presumed to have died fighting in a long-range duel with Devlin Stone. On this day, Coalition forces routed the Blakists from their defense positions outside of the Devils Tower complex here in western North America, despite being hampered by major disturbances in the upper atmosphere that have made communications spotty at best beyond 500 kilometers."

*[Image changes, showing guncam footage of Blakist 'Mechs moving forward with other mixed forces. The view shakes and static erupts after a near miss from a Blakist PPC strike. Images from the battle play as Holmgren continues.]*

**[Holmgren]:** "Precentor Martial St. Jamais did not give the Coalition much time after a concentrated NBC missile assault on Stone's position at Sundance. The Word launched a preemptive strike around 0600, which quickly turned into a furious engagement. The reinforcements recalled from the Pacific Northwest were the first major casualties, caught in transit by a nuclear detonation some 100 kilometers to the north.

"With the loss of reinforcements, the Word surged forward in a massive attack across the Coalition's lines in an apparent attempt to break and scatter Stone's forces. The lines bent, but ultimately held, snapping back towards the Blakists with the arrival of General Stone and an ad hoc command company. The General then moved from point to point along the battle line. Soon his troops began to push forward, forcing the Word back step by step, each side paying in blood and metal for every meter of ground."

*[Image shifts to an overhead shot, taken from a VTOL. At the edge of the frame can be seen an Atlas II trading ranged fire with a lumbering Awesome. The action pauses as each 'Mech's image is highlighted, then zoomed in. A furious battle is played out as Holmgren continues.]*

**[Holmgren]:** "As the battle raged along the steppes, both Stone and St. Jamais engaged. A field of death cleared around the engagement as the fighting tapered off around them. Any unit caught within the vicinity of their duel was savagely destroyed. Suddenly, the *Awsome* fell to the ground and was gutted by the *Atlas II*, causing a blinding plasma explosion that knocked Stone's 'Mech over. For a brief moment, even I thought the Word would surrender on the spot, their leader now dead in the sand."

*[Image shifts to other footage of the battle as Holmgren continues.]*

**[Holmgren]:** "But despite the apparent loss of their Precentor Martial, the Word continued to fight hard for Devils Tower. One DropShip was detected blasting free of the wreckage near the

## MILE-HIGH MUSHROOM CLOUD WITNESSED

(26 November 3078)

Terra [INN] — Eyewitnesses report that the Word may have struck at a Coalition column near Denver and that nuclear weaponry was used in the exchange.

There has been a flurry of reports from partisan cells along the Rocky Mountains. Most of these reports are still unverified.

Through yesterday, General Stone has been engaged in mop-up operations near Albuquerque and Colorado Springs. While the nature of such operations necessitates loose and open formations, there is a chance that forces were setting up a new base camp. Unfortunately, INN has no information assets with these forces, so the current situation is far from clear.

Of concern to the Coalition commanders here at Sundance are reports of a strategic nuclear detonation in the vicinity of Denver itself, including a "mile-high mushroom cloud." None of these reports have been verified and it is impossible to make contact with numerous other cities in the area at this time.

## COASTAL CONFUSION

(18 December 3078)

>>Excerpt commences: 19:33  
(Greenwich Standard), 18-DEC-78<<

*[Image of a helicopter several kilometers off the coast of Hilton Head Island, then shift to an image focused on the tense face of an INN reporter.]*

**[Voice (ID: Viktor Yamana, INN Reporter)]:** "This is Viktor Yamana, reporting from the fringes of the siege on Hilton Head Island. I have commandeered a private local helicopter to obtain a firsthand view of this centuries-old capital of ComStar and, now, the Word of Blake. The air defenses seem to be so battered that few aircraft are intercepted by Word fighters anymore; they simply don't appear to have the fighters left to do so.

"Oddly, this island is not a traditional seat of Terran government, but became a vacation resort in the late twentieth century and remained so until late in the days of the first Star League. Only an economic downturn led Hilton Head to seek a new industry by supporting the Hegemony government, particularly HPG communications.

"That relaxed resort island is long gone. The magnificent ComStar campus is gone. Instead, it's now a battered moonscape of craters

from orbital bombardment of key fortifications. Artillery and bombing raids have smashed the ancient oaks and pummeled the wetlands and coasts. But compared to the horrors these Word monsters have wrought on their own world, this is noth..."

*[Yamana trails off as something happens outside the helicopter. The camera pans to look at the cratered island, where eye-searing points of light are bursting from the ground and racing skyward.]*

**[Yamana]:** "Something's happening. Is the camera—? Good. Look at those launch plumes! Those aren't fighters, not at the rate they're climbing. Those must be capital missiles, headed for orbit. And we don't have any way of knowing if Coalition WarShips are nearby. Circle around—"

**[Voice (ID: unnamed pilot, Terran)]:** "Those air defenses?"

**[Yamana]:** "Yes, yes, stay clear of the air defenses, but circle along the Pacific coast of—"

**[Pilot]:** "Atlantic, you offworld barbarian!"

**[Yamana]:** "Atlantic, whatever! See if you can climb a bit so we can pinpoint those silos. Are there more? Can anyone tell what model of missile those were?"

*[The report pauses for ten minutes. When it resumes, it is looking over the ocean toward Hilton Head Island and struggling to adjust to the titanic flashes of light battering the island. Yamana's voice is barely audible over the concussions.]*

**[Yamana]:** "Well, there's your answer! Whatever Hilton Head's silos have been launching brought Coalition WarShips overhead in spades! I think...yes, turn the camera up! Look at the sky!"

*[Through the flickering fringes of the rotor disk, brilliant columns of light fall from several points in the blue sky. Several of those points are clearly drifting in the minute the camera is turned toward the sky, but one is stationary and surrounded by red and green auroras visible even in the sunlight.]*

**[Yamana]:** "If I'm not mistaken, those auroras are from a WarShip that has halted in orbit and is hovering over Hilton Head to extend its bombardment. Its...God! *The sea!*"

*[The camera pans down to look back toward burning Hilton Head in time to catch the ocean around the island jump into a sea of white froth. The entire island begins to heave and bulge upward with shocking speed.]*

**[Yamana]:** "Get us out—" *[static]* "—fireball—" *[static]*

>>Excerpt ends<<





## LATE 3078: DESTINATION TERRA

## BLAKIST ESCAPE

&gt;&gt;VID#5229DESSADEC.ISNS,12DEC78.000242&lt;&lt;

**[Dessadec]:** "This is Alexis Dessadec on the Nova Cat WarShip *Hunter*. We've just detected several DropShip launches out of North America and now we're on a high-speed intercept course."

*[Camera moves and sets on a close-angle view of a Clan officer focused intensely on the ship's primary viewscreen.]*

**[Star Admiral Erik Devalis]:** "TacOps! Situation report."

**[Sensor Tech Jonas]:** "Two Word DropShips, *Lion* and *Confederate*-class, lifting from North America. Estimated time to intercept: one minute, twenty-three seconds."

**[Devalis]:** "Helms, angle point three-two deflection. Flight Control, launch Alpha and Beta Stars. Weapons, prepare a brace of Barracuda. I do not want our prey to slip past."

**[Crew]:** "Aff, Star Admiral!"

**[Dessadec]:** "So, as you can see—"

**[Devalis]:** "Someone get this *freebirth* trash off my bridge before I personally throw him out of an airlock!"

**[Dessadec]:** "Hold on, now! I'm just doing my job—"

*[Camera pans around the bridge as crewmen move about the vessel in a flurry of activity. A female crewman roughly shoves the camera aside.]*

**[Sensor Tech Keaton]:** "Star Admiral, we're being targeted by ground systems...location is west-central North America."

**[Devalis]:** "Near Stone's command? Keep us out of range of their guns."

**[Keaton]:** "Missile launch! Four hostiles, three-five-five kilometers!"

**[Devalis]:** "Evasive action! Employ counter-measures. Recall fighters for point defense."

*[Devalis turns and looks into the camera with a feral smile.]*

**[Devalis]:** "It is a good day to die, *quiaff?*"

—Video fragment recovered during salvage operations, 29 December 3078 (recorded 12 December 3078)

site..." *[Image shows a Buccaneer rocketing past the camera.]*  
"...and shortly after that, the Tower complex imploded. Many troopers have reported feeling the ground shake violently at the time of the internal explosions."

*[Footage of Devils Tower collapsing.]*

**[Holmgren]:** "What few Blakist forces remained began surrendering to Coalition forces immediately after that. News of St. Jamais death—along with the footage you just saw—is now being broadcast to the rest of Terra, though disruptions in the ionosphere are still making global communications spotty.

"Nevertheless, General Stone believes the total surrender of the Word is imminent."

—Report filed by INN reporter Nigel Holmgren, Terra, 19 December 3078

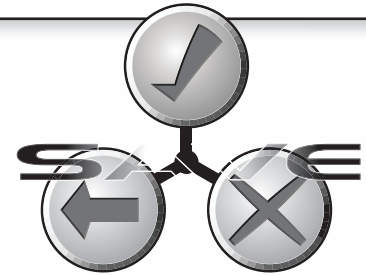

KIRI-J(F) SYSTEM SECURITY SCANNER (12.3.89 BUILD 505)

.98

.76

SECURITY LEVEL AMBER



## NOTICE OF END OF HOSTILITIES

### NOTICE OF END OF HOSTILITIES

(26 December 3078)

Terra [INN] – BREAKING NEWS! The war on Terra has finally ended with the formal surrender by Precentor TerraSec David Alsace—the Word of Blake’s highest-ranking official currently active on Terra—to Devlin Stone, commander of the allied Coalition. As the *de facto* Precentor Martial for all Word of Blake military forces in the Terran system, Alsace was taken into protective custody by Coalition security forces in Geneva immediately after the signing of the surrender notice.

A formal peace treaty is expected in the coming weeks, but the text of the surrender declaration is available below.

### NOTICE OF END OF HOSTILITIES

1. This Notice functions as an Act of Military Surrender by the authority of the undersigned, Precentor Martial David Alsace, provisional commander-in-chief of all Word of Blake forces within the Sol system, and ultimate civil administrator of Terra
  - a. Sol system understood to include the volume of space within and including the Sol Oort Cloud.
  - b. This armistice to exist for a period of 180 days effective 23 December 3078
    - i. This term to be extended by order of Devlin Stone, with concurrence of David Alsace
  - c. This Notice is considered binding to all Word of Blake military forces, as well as all other authorities and organizations operating in any capacity within the Sol system, be it military or civil.
  - d. Military forces are defined as any aerial, naval, ground or space-based units and individuals, as well as any other units or individuals bearing arms as a member of the Word of Blake
2. All Word of Blake entities, as defined above, will execute the following orders:
  - a. All entities must cease any active operations and must remain in their current positions
  - b. All equipment and resources must be preserved and remain undamaged, to include:
    - i. All weapons of any kind, type or origin
    - ii. All combat- and support-vehicles
    - iii. All BattleMechs and IndustrialMechs
    - iv. All surface naval vessels
    - v. All aerial craft, including aerospace fighters and any small craft
    - vi. All DropShips, JumpShips and WarShips
    - vii. All consumables
    - viii. All supplies and parts
    - ix. All properties of intellectual nature and origin
    - x. All equipment and facilities available to the entities
  - c. All to submit themselves to the orders and directives placed on them by any Coalition forces or officers; such orders and directives may not conflict with the above except in cases of humanitarian need
  - d. Failure to act in accordance with this Notice will subject units and individuals to any and all punitive actions as executed by the Coalition
3. This Act of Military Surrender is without limitation or prejudice and is to be superseded by the formal Peace Treaty with the Allied Coalition
  - a. Precentor David Alsace (Precentor TerraSec/Acting Precentor Martial, WoBM) is to function as a negotiating party
    - i. Precentor Martial David Alsace to appoint deputies and aides from within his organization to assist with the negotiations as he deems fit, and as permitted by the Coalition
  - b. Peace Treaty is to achieve the act of debilitation with regards to the Word of Blake authority and organization on Terra

**Signed:**

*David Alsace*

David Alsace

Precentor TerraSec

Word of Blake

**Signed:**

*Devlin Stone*

Devlin Stone

Commanding General

Coalition of Allied Powers



## LATE 3078: DESTINATION TERRA

## GIBSON ATTACKED?

**[Holmgren]:** "This is Nigel Holmgren with a news update concerning rumors surrounding Gibson. I was able to catch up and asked Devlin Stone to clarify the situation on Gibson."

*[Image shows Holmgren walking up to General Stone as he exits a mobile command unit.]*

**[Holmgren]:** "General Stone, sir?"

**[Stone]:** "I don't have time, Nigel."

*[Stone attempts to join his waiting staff, Holmgren follows.]*

**[Holmgren]:** "General, have the Regulans attacked Gibson, sterilizing the planet with a massive nuclear assault?"

**[Stone]:** *[Stops]* "Nigel, I said no comment, damn it!"

**[Holmgren]:** "Sir, can you confirm this or not?"

**[Stone]:** *[Pause]* "No. Move!"

—INN News report, filed 30 December 3078

## CAIRO SURRENDERS

(3 January 3079)

Cairo [VOTD] – Two days ago, what little opposition remained in Cairo acknowledged their unconditional surrender. The seven-month battle has been one of the longest campaigns on Terra.

Even after news came of the death of Precentor Martial St. Jamais in North America, Word forces here conducted repeated counterattacks, pushing *Kanrei* Minamoto's forces out of Giza long enough to recapture a small military DropPort. In a bold move, the *Kanrei* personally lead the Coalition's counterattack, catching the Blakists out of position and capturing Precentor ROM Kernoff and a small retinue of bodyguards. (Unfortunately, Kernoff and his men died while in custody, though the *Kanrei* and his staff deny any wrongdoing.) With complete surprise achieved, the *Kanrei* then secured the facility and immediately pushed straight for the Castle Brian.

Shortly before the renewed assault overwhelmed the fortress gates, David Lear appeared at the mobile command base and met privately with the *Kanrei*. After Lear's departure, Coalition forces were ordered to withdraw back towards the Suez. The reason became apparent with the commencement of intense orbital bombardment and tactical nuclear artillery strikes. The massive conflagration lasted for several hours and seemingly melted the fortress into the sand; even now, a ten square-kilometer area around the ruins remains under official quarantine.

The death toll from the bombardment may never be truly known. Several of the naval strikes missed the facility by as much as ten kilometers. With the city already ravaged from the months-long siege, it is unknown how many civilians remained living in that war-torn hell.

The few Word forces scattered in the surrounding delta region surrendered to Minamoto's forces shortly after the destruction of the Castle Brian. The long battle for Cairo is now over.

## TOWRA POINT FALLS

*[A jubilant Orson Tanaka stands in front of the camera. Behind him military forces bearing the colors of the Star Seeds are rounding up a large number of forces dressed in various types of Blakist military outfits.]*

**[Tanaka]:** "Terra is ours. I can state this with absolute certainty. The price was hardly a bargain, with hundreds of millions dead across the globe. However, the last organized resistance has finally capitulated here at Sydney's Towra Point. Little did we know that after capturing the undersea tunnels leading into Botany Bay that another two months of fighting would follow. The Word of Blake pulled back into the massive Sekkaris facility in the bay just as expected. What happened next, however..."

*[Footage of various combat units, mostly infantry teams and battle armor squads, intermixed with artillery fire and Coalition commanders.]*

**[Tanaka]:** "Overwhelmed once surrounded, the enemy forces retreated back to their facility. Stone's troops used heavy bombardment, both artillery and air support, to soften them up. A massive push then cut deep into the complex. However, using their knowledge of the facility, the Blakists were still able to flank the Coalition. Nearly the entirety of the complex was overrun without any clue of a headquarters or secure base of operations. That was until additional tunnels were found.

"The sprawling facility that covered a huge portion of Sydney was only a third of the entire Sekkaris plant. Most was located beneath the waves of Botany Bay. Much like the struggle earlier for the undersea tunnels, these turned into another bloodbath. Hundreds died trying to dislodge the Blakists from their undersea snakehole, but to little avail.

"Finally, General Belle Lee made a fateful decision. Despite the fact that innocents were undoubtedly comingled with enemy combatants, she could not keep sacrificing her own people this way. The tunnels were ordered collapsed. The populace down there would either drown or suffocate. Salvage teams were requested from other areas to assist in eventual rescue efforts."

*[Images of salvage platforms, rescue efforts, collapsing rubble and underwater explosions.]*

**[Tanaka]:** "But still, the Blakists refused to die. Emerging from even more hidden tunnels, they converged on the Towra Point peninsula. There they continued their fight, despite the knowledge that the rest of their allies on Terra had already fallen, or the fact that the Precentor TerraSec had already issued a cease-fire order to the remnant Word of Blake forces. In the end of this counterassault, the Blakists deployed another of their nuclear weapons, vaporizing several DropShips along with their crews, passengers and cargo, then withdrew again. Thus both sides waited. And waited..."

*[Footage of a mushroom cloud and burning DropShips.]*

**[Tanaka]:** "Until today. Low on food and supplies, and with no hope of achieving victory, the surviving enemy troops contacted

## LATE 3078: DESTINATION TERRA



General Lee to arrange a cease-fire and then surrendered. Wary of yet another Blakist ruse, the Star Seeds mercenary command was moved in to ensure that the Word's capitulation was complete before Lee finally accepted the Word's surrender. This action ended the last major fighting in the Terran solar system. Yet even though all organized resistance is over, Terra is not yet free of Blakist influence. Small groups and individuals reportedly persist even now, attempting to drag out the fighting in scattered pockets."

*[Image of the Word of Blake flag being lowered as prisoners march past.]*

**[Tanaka]:** "Nevertheless, the heart of Blake has been ripped out this day. Terra is ours."

—News report filed by Orson Tanaka for VOTD, 5 January 3079

## TERRA IS NOW FREE

To the people of Terra, and to all people everywhere:  
You are free.

I realize this is a hard concept to understand, as you have believed in your freedom ever since the Word of Blake—and ComStar before them—took control. But I come to you today to tell you that it has been a lie, conceived to utterly deceive you into serving the will of evil dressed in the robes of technology, order, and neutrality. That truth as you know it is a sham and dishonors you as a people.

Your lives are your own, of course. But the order in which you served exists no longer. Through the bloody sacrifice of millions upon millions of people across the interstellar night, the oppressive regime you unknowingly obeyed and died for has been overthrown.

Yet your lives have not been for naught. Indeed, here at the cradle of humanity lies the foundation of the greatest star empires ever seen in the universe; the determination, pride, resilience, and honor given and shown by the Terran people have been the benchmark for all the rest of the Inner Sphere. Because of the old order that dominated this world for centuries, however, your potential has been capped. Limited. Restricted.

Today, that order exists no more. And the limits have been removed. You are able to stretch forth your hands and attain greater heights, greater victories, greater lives. The stars are no longer the limit—only you are.

None here on Terra can be held by those who lie beyond as an enemy, because at our core, all mankind shares in the common hunger for peace, fellowship, and justice. Humanity's ultimate well-being cannot be served in such isolation as seen here in such raw display; only through effective cooperation with the rest of the universe can we achieve greatness.

Our hope of lasting peace cannot be based upon secrets, weapons, oppression, and the devaluation of humanity simply because of their allegiance. Honest understanding and the strength of our unity is the key to open peace and lasting

harmony. We must strive to prohibit strife, to relieve our tensions, and to banish our fears.

We stand today not as conquerors of Terra, but as liberators. Partners. Brothers and sisters. Bound together to raise each other up and rebuild from the horrors of centuries of war.

It is a dream that is possible today. A dawning of understanding and a blessing of hope.

Because today, Terra is free.

—Transcript of Devlin Stone's address to the people of Terra and beyond, provided by the office of David Lear to all news agencies, 6 January 3079

## AND ON OTHER FRONTS...

## INTEL BRIEFING: TD3115



We go now live to Andrew Davion Pavilion where Doris Eldridge, senior public relations officer for MIIO, is holding a press conference.

"Thank you for coming, everyone. I'd ask you to please hold any questions until the end, when I will be more than happy to answer anything I can.

"There has been much discussion lately about the Filtvelt Coalition and what the First Princess plans to do about this breakaway nation. I'd like to take this opportunity to reiterate that there are currently and for the foreseeable future no plans to initiate military action against the Filtvelt worlds. The Princess recognizes the rights of these citizens to determine their own destiny, though she hopes that some day they may return to our fellowship of worlds of their own free choice.

"Turning to Filtvelt's neighbors, we have a different message for the pirates who remain as occupiers of the Malagrotta worlds. Major General Marsin is in the final stages of clearing out pirate nests from Malagrotta itself. Last week's recapture of Torida and apprehension of a significant portion of the pirate band operating out of the capital represents not only a major step in liberating the region but also marks the beginning of the end for the marauding and iniquity inflicted upon Malagrotta and surrounding worlds by the pirates of Tortuga. With only three worlds remaining under their dominion, the writing is on the wall for the Tortugans.

"So to them, we say: This is your only warning. You have a very small window of opportunity in which you can abandon the worlds you have stolen from us. A very small window before the full fury of the Federated Suns falls upon you. Leave Csomad. Leave Armington. Leave Vackisujfalu. Leave and never come back.

"Ahem. I will now open the floor to questions."

—ISAP report, New Avalon, 1 November 3078

**BUSINESS OF WAR**

(1 December 3078)

Galatea [MercNet] — Wolf's Dragoons, the Eridani Light Horse, the Kell Hounds and the Blue Star Irregulars. These legendary units probably could have conquered the Capellan Confederation in 3050 with the backing of some conventional regiments. Now hardly any of them are left. The Jihad has been harsh, with the Lexington Combat Group, Little Richard's Panzer Brigade, and Always Faithful joining most of the above in near or total oblivion. The Dragoons are only a shell of their former selves, with rumors abounding of them becoming Stone's vassals in exchange for reclaiming Outreach. The Kell Hounds can hardly form a company after their crushing defeat in Cairo.

Luckily there is new blood in the mercenary world. There were units before the legends of our time and there will be new legends in the future. The Star Seeds have seen their fortunes rise working closely with Stone, the Twelfth Vegan Rangers also continued to shine on Terra. The Twenty-first Centauri Lancers are now on the market, as is Deliah's Gauntlet, survivors of the Blakists on Capolla. Others have joined with states they were linked with, the One-Eyed Jacks becoming the heart of the new Lyran unit the Black Jacks (signing a long-term contract with the Furillo government), while the Canopian Highlanders kept their name as they joined the MAF.

Some of the old guard still lives, however. Hansen's Roughriders performed well in the drive to Terra, though they will need time to rebuild after being so close to nuclear annihilation in the Texas lowlands. There are those who will be charged for their crimes of siding with the Blakists, such as Blanc's Coyotes and Hannibal's Hermits. Even the Highlanders will likely require a full investigation for their actions—or lack thereof—during the Jihad. Like everything in life, those who do well will shine; those who choose or perform badly will fall.

**BUILDING THE WALLS**

**[Steven Hunter]:** "And our final topic before the break: The upcoming invasion by the Federated Suns. Avery, your thoughts?"

**[Avery Carson]:** "I think you should choose another way of leading into that topic."

**[Hunter]:** "Why? Do you not think the Suns will invade us?"

**[Carson]:** "No, I do not."

**[Hunter]:** "Come on, Avery. Surely you're not that naïve? Filtvelt seceded; they want us back. How else are they going to get us?"

**[Carson]:** "First of all, I disagree that they do want us back. I certainly haven't seen any indication. In fact—"

**[Hunter]:** "No indication? Are you mental? Marsin's got forces lined up to bring us to heel!"

**[Carson]:** "Do you have any proof of that at all? Or are you just fear-mongering again?"

**LATE 3078: DESTINATION TERRA**

**[Hunter]:** "Come on, Avery! True or false? Major General Marsin surrounded and crushed the pirates infesting Malagrotta."

**[Carson]:** "True, but—"

**[Hunter]:** "True or false? Marsin has us surrounded now."

**[Carson]:** "True, but—"

**[Hunter]:** "So you admit it!"

**[Carson]:** "Of course I do; I'm not an idiot."

**[Hunter]:** "You just let me be the judge of that, Avery."

**[Carson]:** "But that doesn't mean he's going to lead a charge across the border. In the Princess-Regent's speech to New Avalon Veterans of the Civil War just three weeks ago, she said, and I quote: 'Never let it be said that the Federated Suns is a—'"

**[Hunter]:** "Never let it be said that the sainted Yvonne can't speechify with the best of them."

**[Carson]:** "Can I finish? '—is a nation that must use force to adhere its citizenry to the body politic. Never let it be said that the Federated Suns does not respect the fundamental right of all humankind to choose their own, individual destinies.' They aren't

**TARGET: GIBSON**

—Priority message intercepted and posted anonymously to a conspiracy discussion site on Augustine, 22 December 3078 (veracity unconfirmed)

**>>>MESSAGE BEGINS<<<**

Your foresight was indeed correct, the Regulans have gathered a large fleet in space approximately one jump from Gibson. I do not have full numbers, as my cover within this command does not allow me to access the Regular file structure. From my investigations, this force appears largely aerospace-based; ground forces may be with another fleet.

From what I have been able to piece together, the Regulans are preparing for a sustained assault, most likely with the aid of small-scale tactical munitions. This is consistent with their current campaign tactics. Given the enmity that the Regulans feel towards the Domini in general —may Blake damn Naamah and her miscalculations!—it is expected that their reaction to the reclamations on-world will prolong the conflict dramatically.

As such, I would recommend against your return there for the moment. I fear your security cannot be guaranteed, even by Apollyon himself. It seems unwise to risk anything.

What I have learned, though, is of the ultimate importance and could bring about the collapse of the Regulans as a whole: the presence of their Prince aboard this flotilla. I will attempt to learn his location and sabotage the vessel. The loss of their Prince may prevent the fleet from engaging the defenders of Gibson, but I cannot guarantee it. There may be contingency plans in place. I will give my life to prevent as many vess—

**>>>MESSAGE TERMINATED AT SOURCE<<<**

## LATE 3078: DESTINATION TERRA

## SYSTEM ERROR?

Lin:

I'm getting very troubling reports from a few of our cleaners within the Protectorate. My staff wrote this off as just a few coincidences. I mean, how many systems and data nodes have we captured during SCOUR? But it's become too many coincidences and I believe we're seeing the beginnings of something I'm not quite sure we're prepared for.

At first it seemed that our cleaners were coming up against some stubborn encryption patterns in various Blakist data blocks. A couple of cases were attributed to viral attacks that somehow originated outside these supposedly closed systems; this is what made Galen and I stand up and take notice. We got reports of corrupted blocks, wiped data, missing file components, and so on—all within Blakist-oriented file blocks and servers.

On New Home, we managed to trace the viral pattern back through several planetary system points; nearly all of them coincided with the four main HPG relays (and in one case, timed with a surge in HPG activity around mid-November). Our agents there suspect this was a viral attack initiated out-system, which

means that somehow, the Word managed to drop and trigger some sort of "poison pill" into New Home's planetary relays without ComStar's techs being aware of it.

If the New Home incident is related to these other "coincidences", we may have a serious problem on our hands. We've captured a lot of Blakist technical documentation and correspondence—much of it still encrypted—and if there's a widespread viral purge going on, we need to act right now. I know part of Stone's protocols is to back everything up in triple-redundancy formulas, but even that may be in jeopardy: our team on Epsilon Eridani had a disturbing report where one of our "safe" data storage relays not only burned to the ground, but the memory chips were slagged by a thermite application... something that no computer program could ever initiate.

I sincerely hope this is nothing, but we may well have another Holy Shroud operation occurring.

—Marcel

—*Unconfirmed memo, posted in Skye Interstellar Today, 29 December 3078*

going to force us back into the Suns, no matter how much you lot scream about it."

**[Hunter]:** "You keep telling yourself that when the Federated jackboot is on your neck. We'll be right back after a word from our sponsor."

—*Hunter v. Carson, Filtvelt Broadcasting System, 19 November 3078*

## CHRISTMAS ON GIBSON

(27 December 3078)

Terra [ISAP]—With the celebrations surrounding the victory on Terra occupying the minds of most people, it is easy to forget that the Word still has strongholds around the Sphere. The most well known of these is the pseudo-capital of the hated Manei Domini in the former Free Worlds League: Gibson. Site of a failed assault by the Regulans four years ago, Gibson is today on the tip of peoples' tongues, with rumors of a massive offensive underway flooding the HPG network.

While no organization has claimed to have the full picture as to what is occurring, what is known is that Prince Titus Cameron-Jones of Regulus has gathered a large flotilla of JumpShips; his nation has a vicious history with the Manei Domini that haunts this world. But after the savaging they received last time they assaulted this planet, it is little wonder that the Regulans are reticent about confirming the rumors, especially if they have again suffered a massive defeat at the hands of the Manei Domini and their monstrous Precentor Apollyon.

What is known is the Regulans have thrown a communications blanket over the system, with no JumpShip traffic allowed to

leave, and it is assumed any ships entering the system are being subjected to the same strictures. This has made it impossible to verify whether or not the Regulans have simply blockaded Gibson, or if they have something more aggressive in mind.

Ultimately, however, the blockade of Gibson demonstrates to the people of the Inner Sphere that the Word truly is defeated, and that we can once again breathe a sigh of relief.

## HORROR SHOW

(31 December 3078)

Gibson [SBC] – **[Reporter]:** "When it was first reported that a Regularan flotilla had entered the Gibson system, most observers assumed that it was the harbinger for a massive Regularan assault to cleanse the world of the Manei Domini. And they were right. But not in any way that they ever expected. We wish to advise that some viewers may find the following images disturbing."

*[Image slideshow starts, obviously an interval camera taking an image every few seconds. In the picture is the green and blue globe of a planet. In the foreground a fleet of DropShips can be seen firing their retrojets. Small explosions arc as aerospace fighters engage each other.]*

**[Reporter]:** "The vision of Gibson, leaked out through a mercenary officer who wishes to remain nameless, is horrific. We have seen footage throughout the Jihad of the extreme atrocities carried out by the Word, but even those cannot compare to the brutality demonstrated by the Regulans. We can see as the Regularan fleet enters the upper atmosphere the defenders of Gibson engaging the cloud of aerospace fighters accompanying them."



LATE 3078: DESTINATION TERRA 

*[Massive detonations dot the atmosphere.]*

**[Reporter]:** "Here we can see the Regular fleet taking out the defenders' DropShips with nuclear warheads. This is a typical Regular tactic, and is not surprising given the animosity exhibited. Watch as the aerospace fighters enter the atmosphere."

*[The cloud of fighters descends into the atmosphere from multiple angles.]*

**[Reporter]:** "It is assumed that the Regulars released their ordinance at this point. Watch what happens..."

*[As the images progress the world is covered with bright blossoms, visible as a glow through the clouds. As one blossom subsides, it is replaced by more. Soon the visible part of the world is wreathed in fire.]*

**[Reporter]:** "Those aerofighters did not return. They were suicide bombers. It is supposed they literally flew into the ground to hit the hardened Blakist structures. After the break we will look at more footage, but we leave you with this, a message from the grave."

*[A gravelly voice starts talking over the images, malevolence filling each word.]*

**[Apollyon]:** "You think you have defeated us? You think you have defeated the Master's Chosen? Your efforts are for naught, Prince! We are Domini! I am Domini! We are ethereal! We are eternal! *Blake eleison!* We will you fight you until the heavens burn, and the skies fall..."

**ALERT: ALSHAIN**

**[Foster Williams]:** "If you're just joining us, there has been an explosion in downtown Silverdale tonight. Centered on the Omni-Paradise Hotel, where a gala New Year's Eve celebration was underway, the blast has apparently taken out much of the

hotel's structure. We go now to Denneth Lanzer, live on the scene. Denneth?"

*[Camera shows a reporter standing at a distance from a chaotic scene of rescue vehicles, firefighters, police helicopters and more.]*

**[Denneth Lanzer]:** "Thank you, Foster. Behind me is what's left of the Omni-Paradise Hotel. Shortly after eleven p.m. this evening, a massive explosion ripped through the building. As you can see, the entire northeast façade of the hotel is simply...gone."

*[Camera pans wide to show the devastation. One side of the building is missing, with a massive crater in its place. The remaining structure seems to slump in on itself.]*

**[Lanzer]:** "The Omni-Paradise was host tonight to a New Year's celebration that boasted the attendance of the entire Unity Council, as well as luminaries from every sector of Rasalhagian society and Ghost Bear caste. No word yet on any casualties, though the death toll is expected to be high."

*[Camera goes split-screen, with Williams on left and Lanzer on right.]*

**[Williams]:** "Denneth, do authorities have any idea who might be responsible for this atrocity?"

**[Lanzer]:** "If they do, Foster, they aren't releasing that information yet. Of course, the thought on everyone's mind is Word of Blake. Given their actions on Radstadt and Thule just a few years ago and with the recent liberation of Terra, it would not be a stretch to think they triggered this explosion, but it is too early to say for sure."

**[Williams]:** "Let's hope we find out soon. Thank you, Denneth."

*[Camera returns to studio view.]*

**[Williams]:** "While we wait for more news on the blast, let's take a look at some footage from earlier in the evening."

—ISNS breaking news, Alshain, 31 December 3078



## CHAOS ETERNAL: JOYRIDE

**JOYRIDE**

**[Sentry Four]:** "Titan Control, I'm picking up some incoming bogeys on my screen. You getting it too?"

**[Titan Control]:** "Confirmed, Sentry Four. Looking like a group of small craft."

**[Sentry Four]:** "Copy that. Should we move to intercept?"

**[Titan Control]:** "Hold; I'm requesting a declaration of intent."

[Pause]

**[Titan Control]:** "That's a negative on the intercept. Just another Belter convoy looking to trade."

**[Sentry Four]:** "That's the fourth time this week, just what do they have that's so valuable to trade, anyway?"

**[Titan Control]:** "Exactly. That's why the CO wants you to do a fly-by. Something's not tracking and he wants to know why."

**[Sentry Four]:** "Roger that. Squad, full burn to investigate."

**SITUATION**

Titan Shipyards, Terra  
Word of Blake Protectorate  
20 July 3078

With Stone putting the final touches on the strategy of taking Terra from the Word, nagging doubts and empty pockets of intelligence still loomed about Terra's system defenses. The Titan Yards were the subject of rumors of a huge defense fleet, but no exact location as to where they were stationed. Stone had to know before risking the lives of hundreds of thousands of soldiers.

Thankfully some of the Belters along the Kuiper Belt were sympathetic to the Coalition. Tired of Blakist interference, they wanted the Word gone just as much as the rest of civilization. So when your team finally hooked up with them, they organized some flybys of the Yards to see just how much information they could gather.

All you had to do was keep them safe should the bottom fall out.

## CHAOS ETERNAL: JOYRIDE

**GAME SETUP**

This is an orbital support operation. Place at least four space mapsheets. The Defender places two large habitats, two small factories, and three large pressurized yards per mapsheet.

**Attacker**

The Attacker consists of a covert team using the player's Aerospace assets, not to exceed 25 percent of their total available force. In addition, the Attacker receives six small craft piloted by Terran Belters. The Belters have Regular skill levels. The Attackers may enter from any one-half of a map edge.

See Special Rules below for instructions on using aerospace craft other than small craft.

**Defender**

The Defender consists of Titan Yard security forces, totaling up to 300 percent of the Attacker's total deployed force, and have Veteran skill level. Defenders place their forces evenly within the hex of each facility.

**WARCHEST**

**Track Cost:** 800 WP

**Optional Bonuses:**

**+200 Leftover Space Junk:** Use the Orbital Obstacle rules (see p.44, SO)

**+300 Something Fishy:** Add a -2 modifier to the Defender's detection roll target number.

**OBJECTIVES**

**1. Scan the yards.** Successfully scan at least six different space facilities. **(Reward: 500)**

**2. Get the Hell out of here!** At least two-thirds of the small craft must exit from their starting map edge. The first objective must be completed first. **(Reward: 500)**

**SPECIAL RULES**

The following rules are in effect for this track:

**Scan the Stations**

At the start of the fire declaration phase, each of the Belters' small craft may declare intent to scan one station. Using their Gunnery skill as a base, add a +1 modifier for each hex between the craft and the target station. Apply a -2 bonus if the Belter small craft is of military (as opposed to civilian) construction and another -2 if the small craft is equipped with an Active Probe. A station can only be successfully scanned once by the Attacker.

**CHAOS ETERNAL: JOYRIDE****Station Security**

The Defending forces will not move from their positions or declare fire until one of the Belters' small craft is detected, they are fired upon first, or if one of the player's aerospace craft spends more than its Thrust rating. Whenever a Belter scans a station, the station scans them back using a Gunnery skill of 5. Using the same modifiers as "Scan the Stations," above, if the roll is equal or better than the Belter's target number, the Defenders are alerted to that craft and will move and declare fire against that craft at the start of the next turn.

The Defender may fire only on Attacker units that have been detected.

**Running Silent**

All Attacker units that are not small craft must enter the board with a starting Velocity of 4 or less and are considered "running silent." These craft may use up to half of its Thrust rating for maneuvering; if the unit uses more than half of its Thrust, its Maximum Thrust rating, accelerates or decelerates, the unit is

no longer considered silent and is immediately detected by the Defender's units and may be targeted and fired on as normal.

**AFTERMATH**

Those crazy Belter pilots got carried away with the "secret operation" and nearly blew it as they continually got too close to the stations. Fortunately, none of the security forces moved from their position as you made your way back out of the fringes of the orbital complex.

You returned as quickly as possible, eager to share data and get the show on the road.

**ADDITIONAL HOOKS**

Those Belters noticed something odd in another section of the shipyards. It may be prudent to check it out before returning to Stone, but is it worth the risk?

**NEXT TRACK**

*Ancient Meanings*

**CHAOS ETERNAL: ROADBLOCK****ROADBLOCK**

*We just sat here for weeks, watching reports as the Coalition forces jumped from system to system, closing in on Terra. Listened how they thwarted every attempt to be stopped before finally flooding Terra's orbit with hundreds of DropShips, stretching planetside. And we saw them arrive. We were outnumbered, outgunned, and knew the scraping pit of fear in our stomachs as their DropShips, fighters, and falling 'Mechs fell from the sky like candy from a huge piñata.*

—Journal entry, J78-215

**SITUATION**

*Outskirts of Rio de Janeiro, Terra*

*Word of Blake Protectorate*

*19 August 3078*

The fight on the ground for Terra had finally begun.

From the Titan Yards to close Terran orbit, Stone's Coalition had already been in constant fighting before they could even make out the continents of the cradle of mankind with their own eyes.

Now they were hovering over it.

With combat drops all over the planet, one cluster of DropShips apparently had Rio as a target. They were going to land right on your doorstep, right into your waiting arms.



## CHAOS ETERNAL: ROADBLOCK



### GAME SETUP

Set up a mix of Wooded, Flatlands, and Hills Terrain mapsheets (see p. 263, *TW*). Aerospace units may only do Air-to-Ground Attacks (see p. 242, *TW*) unless the Proper Air Cover option is used.

### Attacker

The Attacker consists of the Fifth Crucis Lancers and is equal to 125 percent of the Defender's total deployed force. Designate one unit as a Command Unit. At least 10 percent of this force must consist of aerospace units.

The Attacker's ground forces enter the battlefield on a Combat Drop (see p. 22, *SO*), and may not target any hex less than 8 hexes away from a map edge.

### Defender

The Defender consists of up to 100 percent of the player's deployed force. The Defender may enter any map edges of their choice during the Movement phase of turns 1 and 2.

Secretly designate one Heavy or Assault unit as a Commander of Elite skill level. This unit must be a vehicle or BattleMech unit.

### WARCHEST

**Track Cost:** 1,200 WP

#### Optional Bonuses:

**+800 Proper Air Cover:** Aerospace units may move and fire as normal, using Aerospace Units on Ground Mapsheets rules (see p. 91, *TW*) and other advanced Aerospace rules as desired.

**+800 Bringing in the Big Guns:** On turn 11, the Attackers also land an upgraded *Excalibur*-class DropShip of Veteran Quality on an appropriate portion of the mapsheets closest to the center. If the Attacker wishes, or contains units unable to perform combat drops, the DropShip may deploy the remainder of their forces here.

**+300 Jungle:** Treat all light woods hexes as Heavy Jungle, and heavy woods hexes as Ultra-Heavy Jungle. (see p. 31, *TO*)

### OBJECTIVES

**1. Contain Them.** Destroy / Cripple more than two-thirds of the Attacker's ground forces. **(Reward: +1,000 WP)**

**2. Is that Jon Davion?** Destroy / Cripple the Attacker's Command Unit. **(Reward: +400 WP)**

### SPECIAL RULES

The following rules are in effect for this track:

#### Forced Withdrawal

Both sides are operating under Forced Withdrawal rules (see p. 258, *TW*).

#### Salvage

There is no opportunity for salvage in this track.

### AFTERMATH

You thought you had your sector contained, but when those DropShips roared over and dismounted all those troops, you were simply overwhelmed by numbers. The Coalition swiftly established beachheads and captured a nearby TerraSec supply depot and repair facilities. This group was here to stay and for the moment, there was nothing you could do or say otherwise.

### ADDITIONAL HOOKS

Feeling confident, Marshal Jon Davion's task force will most likely push forward towards the SDS Command fortress in order to make it easier for Coalition ships to provide orbital support. The only thing between them and the facility is your unit.

### NEXT TRACK

*Suffrage of Saints*



## CHAOS ETERNAL: ANCIENT MEANINGS

## ANCIENT MEANINGS

*When I heard what their situation was, I really felt bad for them. They really were on their own for years. Being hunted down like wild animals, an unsympathetic minority—how isolated they must have felt! They were literally living off the land through what small animals they could catch just to keep from starving. And yet as I watched the explosions like raindrops in a puddle, I could only think to myself ‘Geez, I’d rather be down there with them than up here right this moment’...*

—Journal entry J78-531

## SITUATION

*Outskirts of Athens, Terra  
Word of Blake Protectorate  
19 August 3078*

You’ve not even made landfall and yet you and your unit have witnessed more combat than you could have ever imagined. And believe it or not, others have seen worse.

There were reports of Com Guard troops who survived Case White hiding out and scattered across Terra, literally living in fear and off the land. Stone wanted connections made with them for several reasons, and while the sky rained fire and troops, you and your men were to find and link up with the “resistance” before the Blakists purged them forever.

## CHAOS ETERNAL: ANCIENT MEANINGS

## GAME SETUP

This is a ground combat only track. All Aerospace assets are tied up in orbital sorties.

Set up a mix of Hills and Mountain Terrain (see p. 263, *TW*). The Attacker places an additional 1D6 wooded hexes (up to half may be heavy woods) and 1D6 rubble hexes per mapsheet. There should be a minimum of three mapsheets.

## Attacker

The Attacker consists of up to 25 percent of the player’s total available force.

The Attacker enters from any one edge of the battlefield. Secretly place an additional six units as per Hidden Units rules (see p. 259, *TW*) on one-half of the battlefield. These are Com Guard resistance units and are of Regular skill level. Assign 2D6 damage in 5-point groups to each unit, re-rolling any results that would cause the unit to become Destroyed or Crippled.

## Defender

The Defender consists of TerraSec forces, is 200 percent of the Attacker’s deployed force (without the resistance units) and are of Regular skill level.

The Defenders enter from the side opposite the Attacker at the start of Turn 2.

## WARCHEST

**Track Cost:** 1,200 WP

## Optional Bonuses:

**+400 Triangulation:** The Defenders may have any portion of

their forces enter from any edge of the maps, not just their home edge. Units enter between Turns 1 and 3.

**+400 Faulty Intel:** Add three more positions to the hidden resistance units. Upon revealing the position (by either the Attacker or Defender), roll 1D6. On a 4 or better, the position is empty. Continue this until all the resistance units are located or three empty positions are revealed.

## OBJECTIVES

- 1. Leave No Man Behind.** At least two-thirds or more of the Com Guard units make it off the board via the Attacker’s home edge. **(Reward: +700 WP)**
- 2. Even Shadows Can Be Dangerous.** Destroy / Cripple half or more of the Defending forces. **(Reward: +700 WP)**

## SPECIAL RULES

The following rules are in effect for this track:

## Forced Withdrawal

All units are operating under Forced Withdrawal rules (see p. 258, *TW*).

## Hidden Resistance Units

The Com Guard units will remain hidden until they are revealed by either the Attacker or Defender. While the Defender needs to detect them normally, the Attacker only needs to get within range and LOS to reveal the unit.

## CHAOS ETERNAL: ANCIENT MEANINGS

**Salvage**

There is no salvage possible in this track.

**AFTERMATH**

It almost wasn't worth the trip. There were only a handful of resistance units left, and the recovery teams took more casualties than troops they extracted.

But the symbolism of the operation meant the world to the Coalition. No one would be abandoned to the Word. One way or another, you were no longer alone in the wilderness.

**ADDITIONAL HOOKS**

There are rumors of more surviving resistance units out there waiting to be rescued. They're worth the effort, as these rebels have crucial intel on area Blakist positions and possible contingency plans.

**NEXT TRACK**

*Counterstrike*

## CHAOS ETERNAL: COUNTERSTRIKE

**COUNTERSTRIKE**

**[Badger Three]:** "Confirmed, Golf Two. They are pulling out and destroying anything of use."

**[Golf Two]:** "Copy that, Badger Three. Can you see whose sector they are heading towards?"

**[Badger Three]:** "Uh...Holy hell, they are heading straight for your position!"

**[Golf Two]:** "Got a count on how many?"

**[Badger Three]:** "It's all of them! They are all moving at once. Looks like in under an hour."

**[Golf Two]:** "Return to base for refueling and rearming for close air support."

**[Badger Three]:** "I'm hauling ass right now, you'll need all the help you can get."

**SITUATION**

*Geneva, Terra  
Word of Blake Protectorate  
17 September 3078*

The Blakists managed to pull one over on the Coalition yet again. Fooling General Redburn into thinking they'd won England, a sizable portion of the Fifty-first appeared in the rear of the Liberators, shattering the defenses and easily pushing through to the surrounded Fourth Division. Once they linked up, they moved on rather than stand and fight.

They were pulling out of Geneva in a forced march out of the city right through your sector. Redburn made it crystal clear: Hold. The. Line.

## CHAOS ETERNAL: COUNTERSTRIKE

**GAME SETUP**

Set up a mix of Flatlands and Light Urban Terrain mapsheets (see p. 263, *TW*). The Attacker chooses the home edge for both sides.

**Attacker**

The Attacker consists of an even mix of Word of Blake's Fourth Division and the Fifty-first Shadow Division, totaling 200 percent of the Attacker's deployed force, and have Elite skills.

The Attacker enters the battlefield from their home edge. Aerospace units may enter the battlefield between Turns 1 and 3 at a Velocity no higher than 5.

**Defender**

The Defender consists of up to 100 percent of the player's total available force. Aerospace units may enter the battlefield between Turns 2 and 5 at a Velocity no higher than 3.

**WARCHEST**

**Track Cost:** 1,500 WP

**Optional Bonuses:**

**+700 Rain of Fire:** The Attacker has a battery of 6 off-board Arrow IV launchers with 30 rounds of various Arrow IV munitions (Attacker's choice). The launchers are considered 3 mapsheets away for flight time and approach from the Attacker's home edge. The launcher crews are of Veteran skill level.

CHAOS ETERNAL: COUNTERSTRIKE 

**+400 Non-stop combat:** Each Defending unit begins the track with only half of their normal ammunition load (round down).

**+500 Elite Soldiery:** Use the Special Unit rules for the Fourth Division and Fifty-first Shadow Division in *Jihad Secrets: The Blake Documents*.

**OBJECTIVES**

**1. Hold the line.** Destroy as many Attackers as possible. (Reward: +200 WP for every enemy unit destroyed before the end of Turn 20.)

**2. You are ordered to Live!** Survive. (Reward: for each Defending unit on the battlefield at the end of Turn 20, +100 WP for Crippled units and +200 WP for Active units.)

**SPECIAL RULES**

The following rules are in effect for this track:

**Light Fog**

This track is affected by Light Fog (see p. 57, *TO*).

**AFTERMATH**

Holding back the Word was like trying to hold back a waterfall; nobody could do it. But you gave them one hell of a time as they pulled themselves out of that city and headed east into the heart of Europe, leaving a trail of bodies and destroyed machines across your sector. General Redburn wanted to give chase. You were more than happy to oblige to make up for your "failure."

**ADDITIONAL HOOKS**

This might be another trap, as more Blakists could be hunkered down in Geneva waiting for things to quiet down before striking the Coalition's rear area. May be time for some house-to-house searching...

**NEXT TRACK**

*End of Night*

CHAOS ETERNAL: SUFFRAGE OF SAINTS **SUFFRAGE OF SAINTS**

*Stone's casualties have forced him to give up on his ambitions to take Hilton Head in the opening stages of the ground campaign. Abandoning the Hilton Head beachhead, Stone pulled his forces to the Dallas-Fort Worth megaplex with all due haste. Though we lack enough forces in the area, a sizable group should be able to surround and eliminate the relatively disorganized task force, possibly even taking out Devlin Stone himself...*

—Excerpt from WOB ROM report on Stone's task force movement, 25 August 3078

**SITUATION**

*Outskirts of Little Rock, Terra  
Word of Blake Protectorate  
27 August 3078*

Pulled out of Rio as it fell in order to reinforce the forces arrayed against Stone himself, you were attached to the Twenty-first Division retreating from the Coalition landing zone near Dallas, heading for Little Rock.

Unfortunately, just as you could see the skyline of the city on the horizon, your pickets started to panic over spotting a group of hostiles implementing their own retreat right into your lines.

How close were they? Your pickets were looking at their *backsides*.



## CHAOS ETERNAL: SUFFRAGE OF SAINTS



### GAME SETUP

Set up a mix of Flatlands, Wooded, and Hills terrain (see p. 263, *TW*).

### Attacker

The Attacker consists of elements of the Twenty-fifth Arcturan Guard, Stone's Lament, and the Seventh Pesht Regulars totaling 200 percent of the Attacker's total deployed force. The units are of Regular, Veteran, and Veteran skill levels, respectively. Designate a command unit for each force; these units possess Elite skills.

The Attacker sets up in the middle of the battlefield. All units must face the Defender's home edge.

### Defender

The Defender consists of up to 100 percent of the player's total available force, augmented by the Word of Blake's Twenty-first Division (which have Veteran skills) and cannot exceed 50 percent of the player's deployed force. The Defender selects their entry edge first. The opposite edge is considered their home edge.

### WARCHEST

**Track Cost:** 1,700 WP

#### Optional Bonuses:

**+800 Broken Morale:** The Twenty-first Division is operating under Forced Withdrawal (see p. 258, *TW*) attempting to exit the opposing map edge before the End phase of turn 10.

**+500 Unprepared:** Each Defending unit begins the track with only a quarter of their normal ammunition load (rounding up), with a minimum of 1 round.

### OBJECTIVES

**1. Kill the Leaders.** Destroy all three of the Attacker's Command units (**Reward: +500 WP**)

**2. Fight On.** More than half the Defenders must survive. Units exiting the home edge count towards this objective.. (**Reward: +1,000 WP**)

### SPECIAL RULES

The following rules are in effect for this track:

#### Salvage

There are no salvage opportunities in this track.

### AFTERMATH

They caught you by complete surprise, flanking your position. You fought well, but the Twenty-first broke early, pulling out of the fight to retreat north and forcing you to follow along or be completely surrounded. Your retreat left Little Rock and its extensive maintenance facilities and foundries to Stone's forces.

While the Twenty-first joined with St Jamais to head to Devils Tower, you got sent to reinforce the Eastern Hemisphere Operations, back towards the teeth of the Coalition's war machine.

### ADDITIONAL HOOKS

Word comes through that pockets of allied troops are wandering around out there, ripe pickings for the enemy. Since salvage has become hard to come by, maybe some rescued troopers will show their appreciation by filling in some of the gaping holes on your roster.

### NEXT TRACK

*End of Day*





## CHAOS ETERNAL: END OF DAY

**END OF DAY**

*I can't friggin believe our orders this time. Assault a Castle Brian?! Do people realize how intimidating those things are to a freelance unit like us? And with no orbital support no less!*

*If we get out of this one alive, I'm not sure if I'm ever going to accept Blakist money again.*

*That is, if we get out of this one alive and can find someone else to hire us. Its not like we can brag about our contracts the last two years or so.*

—Journal entry, J78-615

**SITUATION**

Singapore, Terra

Word of Blake Protectorate

17 October 3078

Terra bathed in flames.

You had seen a lot over the past decade, but nothing prepared you for this sort of no-holds-barred fighting over a single planet. Every square kilometer had seemingly been scarred, littered with destroyed bodies, and wrecked machines.

And it wasn't. Not by a long shot.

## CHAOS ETERNAL: END OF DAY

**GAME SETUP**

Set up a mix of Hills, Flatlands, Coastal, and Light Urban Terrain mapsheets (see p. 263, *TW*).

One map should be from the Light Urban Terrain table and constructed along the lines of a Castle Brian (see p. 141, *TO*).

**Attacker**

The Attacker consists of 100 percent of the Players available force. The Players force is also augmented by a mix of Word of Blake's TerraSec (Regular) forces and the Word of Blake Nineteenth division, of Veteran skill level, and are 100 percent of the Attacker's deployed force.

The Attacker enters from the edge farthest from the Castle Brian.

**Defender**

The Defender consists of up to 75 percent of the Attacker's deployed force, consisting of a mix of the Com Guard First Army and the Fifth FWL Guards, both of Regular skill level. Each unit begins with 3D6 damage, applied in 5-point groups, rerolling any damage that will cripple or destroy the unit.

Openly select three building hexes within the Castle Brian as the Command and Control center which are then upgraded to Hardened buildings of 150 CF.

The Defender sets up anywhere within the Castle Brian.

**WARCHEST**

**Track Cost:** 2,000 WP

**Optional Bonuses:**

**+800 Larger Than Life:** Construct the Castle Brian over two

mapsheets and double its allowed gun emplacements. This bonus can only be taken if there is a minimum of four mapsheets being used.

**+800 It's Quiet. Too Quiet:** Deploy up to two-thirds of the Defender's force as Hidden Units (see p. 259, *TW*) anywhere on the battlefield.

**OBJECTIVES**

**1. Seize the Castle.** Capture all three Command Building hexes by occupying them at the end of the track. **(Reward: 1000)**

**2. Push them out.** Destroy / Cripple at least 75 percent of the Defender. **(Reward: 1000)**

**SPECIAL RULES**

The following rules are in effect for this track:

**Castle Brian**

Use the *Castles Brian Complexes* rules (see p. 141, *TO*) when constructing the Castle Brian. It may contain structures up to 4 levels above or below the map surface, and no more than 12 fixed weapon emplacements (unless the *Larger Than Life* option is used). At least 3 turrets must be dedicated AA platforms.

Because the Singapore complex only recently fell to the coalition before it was counterattacked, all gun crews have a skill of 5 and all gates (if any) are considered locked open.

**AFTERMATH**

You hit the Coalition so hard that even all those gun emplacements could not stop the onslaught. As they withdrew to their DropShips, the few Blakist allies with you activated the

**CHAOS ETERNAL: END OF DAY**

fortress' self-destruct program. As you withdrew as far away as possible you had a grand view of the massive mushroom clouds rising over the landscape.

The outlook of things was still bleak. Even though you won that battle, your unit took horrific casualties. It was so bad, in fact, that Precentor Martial St. Jamais personally offered you the option to stand down and evacuate with the rest of the withdrawing Blakist personnel, as it was becoming apparent that it was just a matter of time before Terra would fall to Stone and his damnable Coalition.

**ADDITIONAL HOOKS**

Even if the Castle Brian was captured in the counterassault, the Coalition won't let such a fortress stand for long in their rear

area, reversing the recent combat. The fortress' self-destruct will cause horrific damage to the surrounding city and countryside, so it's possible any non-combatant friends may need to be evacuated before disaster strikes.

Conversely, fighting to one of the two withdrawal points—Devils Tower and Greenland—may well be an adventure in and of itself, all while evading Coalition attempts to capture or possibly kill you dead.

**NEXT TRACKS**

Time to lay low and lick your wounds while awaiting the next campaign.

**CHAOS ETERNAL: END OF NIGHT****END OF NIGHT**

*Commander,*

*We've been tracking movements of those units that broke out of Geneva and Bratislava and finally figured out where they went through the Urals. Here is where they will be in the next few days...*

—Excerpt from a private communiqué from General Andrew Redburn, 17 October 3078

**SITUATION**

*Ural Mountains, Terra  
Word of Blake Protectorate  
20 October 3078*

You hate to admit it to anyone, but you and your people are tired. On the move since the Word's breakout from Geneva, your unit was constantly playing catch-up but the casualties taken when those Divisions slammed into you made General Redburn doubtful of your operational usefulness.

One of the resistance cells you saved pinned down where a Blakist bolthole might be and passed it along to you personally. With a chance to redeem yourself, you made it clear to Redburn that this operation was yours and yours alone. He seemed to agree—which may be a good or bad thing.

Time would tell.



## CHAOS ETERNAL: END OF NIGHT

### GAME SETUP

Set up a mix of Mountain Terrain mapsheets (see p. 263, *TW*). Set up the maps in a chase format using a minimum of three maps. The Defender chooses their home edge.

### Attacker

The Attacker consists of up to 100 percent of the player's available force.

The Attacker enters from the same edge as the Defender at the beginning of turn 3. Aerospace units may enter from any map edge at the beginning of turn 1, with a maximum velocity of 4.

### Defender

The Defender consists of elements of the Fourth, Sixteenth, and Twenty-first Divisions, the Fifty-first Shadow Division, and general TerraSec forces, totaling 100 percent of the Defender's force. The average skill level of these units is Veteran.

The Defender enters from the edge opposite of their home edge at the start of turn 1.

### WARCHEST

**Track Cost:** 2,000 WP

#### Optional Bonuses:

**+800 Last Minute Hero:** An *Interdictor*-class DropShip with a Veteran crew lands on the map containing the Defender's home edge at the start of turn 6.

**+800 Held Up:** The Attacker's ground forces are delayed and does not enter until the start of turn 4.

### OBJECTIVES

**1. Run them down.** Destroy as many Defenders as possible. (Reward: +200 WP for every Defending unit destroyed, +300 WP for every Defending unit crippled, -200 WP for every Defending unit that exits the Defender's home edge.)

### SPECIAL RULES

The following rules are in effect for this track:

### Non-Stop Combat

Each unit (Attacker and Defender) begins the track with only a third of their normal ammunition load (round up) and 3D6 damage applied in 5 pt clusters, rerolling any damage rolls that cripple or destroy the unit.

### AFTERMATH

Your forces caught the Word at nearly point-blank range deep in the Urals, throwing their already frantic forces into complete disarray. Even with all that, they gave just as good as they got, pounding your men until both sides literally fell apart at the seams. You thought you had them surrounded and done for when a one of those horrific *Interdictors* streaked in from out of nowhere, vaporizing men and machines left and right. It turned from being a fight for reputation to a fight for mere survival.

At the end of it all, none of the Blakist troops survived; combat exhaustion and rage got even the best of your men and they pounded until nothing remained. You received grudging congratulations from General Redburn, who was already packing for the next phase of the campaign.

The war for Terra was far from over, but for you and your men it had taken its toll and you gratefully accepted the offered downtime.

### ADDITIONAL HOOKS

The fighting on Terra still has a way to go before the planet is truly secure. Trigger-happy soldiers can easily sate their thirst with small unit combat, hunting down those who have gone to ground. Or it's possible one of the other theaters is in need of help—and it'll be time to once again mount up and bring war to the masses.

### NEXT TRACKS

Time to lay low and lick your wounds and wait for the next campaign.



connection/JIHAD HOT SPOTS:TERRA/section07: AFTERMATH

AFTERMATH





## AFTERMATH

## AFTERMATH

The war for Terra officially ended with the formal surrender by Precentor TerraSec David Alsace on 26 December 3078. However, pockets of fighting would continue for over a week. With the fall of Towra Point on the fifth of January, all organized resistance to the allied Coalition finally ended. After a years-long struggle, the collected might of the Inner Sphere has finally prevailed.

But while the fighting for humanity's home may be over, the war continues. Having dealt with a central state for so long, it is easy to forget that the Word of Blake began as a far more dispersed organization, much like ComStar itself. Although their hard-fought campaign created a Protectorate dozens of light-years across, this was—to the Blakist leadership—little more than a buffer zone against the rest of the Inner Sphere. Was it also an attempt to recreate the long-lost Terran Hegemony in the image of a Blakist theocracy? That will be a matter for the historians to debate.

But it was not the whole of the Word of Blake that we defeated in 3078. Not by a long shot.

Still unaccounted for, for instance, is the enigmatic "Master". Believed to be the real Thomas Marik (as opposed to the ComStar-concocted double placed on the Free Worlds' throne), this individual is known to be the mastermind behind the Word's massive military build-up, the creator of the Manei Domini, and perhaps the engineer of countless Word of Blake super-weapons deployed throughout the war.

Roughly half of the infamous Shadow Divisions also remain at large, along with several more conventional Militia forces that scattered with the destruction of the Protectorate. These military assets could constitute an army as large as half the Word's peak strength (though a quarter is more likely). That is still more than enough muscle to pose a threat to a major realm.

The Word of Blake also has several known power bases throughout the crumbling Free Worlds League and the local Periphery where they have not been fully ejected. As of this writing, there are hundreds of worlds without active hyperpulse generators to communicate with. Any of these worlds could become secret hiding places for the Blakist remnants, requiring allied forces to scour them, one at a time, to be sure. Rumors of hidden worlds also persist, providing unknown and unseen rallying points.

As long as these threats remain, the war against the Word of Blake cannot be truly said to be over.

But perhaps the hardest fighting is behind us. The ultimate prize—Terra—is now in the hands of an alliance of Inner Sphere and Clan powers. Humanity's homeworld and the Word of Blake's greatest hope for legitimacy and military dominance is now free. As Devlin Stone and his Coalition look toward rebuilding, there is time enough to pause and reflect on what this war has been

## UNSTOPPABLE?

(7 September 3078)

Dieron [DRAKE] — It would not be inconceivable to suspect that once Terra is secured and the last remnants of the Word of Blake is destroyed, that Devlin Stone could move to declare himself the First Lord of a third Star League. With the goodwill of billions of saved civilians and now legions of seemingly loyal battle-hardened troops from the already weakened Houses and assisting Clans, he has a power base that crosses every border, political and cultural. It is no longer a question of capability, but one of motivation.

But what if he did? Would the Coordinator and DCMS be willing to stand to an apparent reincarnation of Ian Cameron? Could the DCMS muster the forces to protect our already-shattered realm from opportunistic outsiders and the other Houses, while experiencing possible new uprisings from treacherous Black Dragon cells and separatist Azami groups? Stone is already using our best forces in the grueling fight for Terra, and what intelligence we've been able to receive is that all of the Dragon's forces have taken heavy casualties. And those were some of the least damaged of what we had left at the start of the Protectorate campaign. After the remnants of the Word of Blake are destroyed, how much of a military force will *anyone* other than Stone be able to claim to have?

One more thing to consider before we answer these challenges as our forefathers have: Many in the Inner Sphere beyond our borders blame the Draconis Combine for the start of the First Succession War. Do we really want that distinction again by opposing what seems to be the reincarnation of a Terran Hegemony, while everyone except the Capellans seem willing to cede authority to him?

about, an epic struggle for hope against the chaos of madness. For the last decade, our generation has been exposed to horrors we've only read about in history texts. The Word of Blake's legacy may well go down in history alongside Stefan Amaris, Claudius Steiner, or Adolf Hitler.

One can only hope that this time we have learned from this legacy that, yes, true evil can exist when allowed to grow, unchecked.

For now, an uncertain future lies before us, as well as the continued hunt to bring the last of the Word to justice before they can rally and rebuild. While there is little doubt that we have cleared the greatest milestone of this war, the struggle for freedom and peace continues...

### WHERE ARE THE SHADOWS?

(12 September 3078)

Mira [FSNS] — Ever since the dawn of the Jihad, the most terrible fighting force the Word of Blake has had at its disposal has been its Manei Domini. Thirteen "Shadow Divisions" of elite cyborgs, piloting the very cutting edge of Inner Sphere

## AFTERMATH

technology. Designed to rip apart the Clans, they have more than shown their mettle against the Great Houses.

But as Devlin Stone's Coalition has fought its way through the Blake Protectorate—and even now hold Terra in their hands—we must ask ourselves; where are the rest of the Shadow Divisions? During the last few years, these forces have shown themselves to be brutal adversaries, capable of the foulest deeds, leaving entire planets dead. But in the defense of the Protectorate, only a handful of these forces appeared, including the Fifty-first on Terra. Sources tell us that the Forty-second, Forty-third, Forty-fifth, Forty-seventh and Fifty-first have been destroyed, and intel reports place the Forty-first and Fifty-second on Gibson.

But that's only seven divisions. Where are the others? People are patting themselves on the back about a job well done, when half a dozen of the nastiest commands the Inner Sphere has seen since the days of Amaris are still out there, waiting. There are claims that they have gone to terrorize the Clan Homeworlds. Some claim that the Com Guards hunted them down, explaining away the brief period where the Second and Third Armies went missing along with Stone, and why only small Shadow elements have been spotted since. But if that were true, you would think they would advertise it loudly. If true in the slightest, did the Com Guards fail?

Meanwhile, all the rest of us can do is sleep with one eye open, and keep a vigilant watch and prepare for the day when the monsters in the Shadows appear again.

**MARS: APPROACH**

*[James Bryson stands with a trio of young soldiers, all smiling and mugging for the camera]*

**[Bryson]:** "With much of Terra secured, the forces of Devlin Stone's allied Coalition move now to seize the final major objectives of the invasion, including Mars. With me now are Captain Nicholas Fairbanks, Sergeant Howard Crawford, and Corporal Jaramir Langer. Gentlemen, thank you for your time and how does it feel to be headed for Mars?"

*[The three exchange glances and Fairbanks moves to speak]*

**[Nicholas Fairbanks]:** "I just wanna say a quick 'hi' to Emma and my parents. Um, it feels...strange? There's a lot of relief that we did the job we came to do on Terra, but nothing's finished yet, you know?"

**[Howard Crawford]:** "Yeah if we stop thinking about what we need to do, that's when it can all go to sh...haywire."

**[Bryson]:** "Would you call it 'guarded optimism' perhaps?"

**[Fairbanks]:** "I don't know if optimism is the right word. We're focused still. I wouldn't mind a few more ships in the task force obviously."

**[Jaramir Langer]:** "Yeah if form holds they've given us just enough stuff to stir up some trouble but not enough to bury the Wobblies for good."

*[All three laugh at the comment]*

**[Fairbanks]:** "Ain't that the sad truth."

**[Crawford]:** "I guess it feels like talkin' about anything is premature, sir. History, the future, all of that stuff—other people can talk about that if they want to, but we're still on the clock. Fact is, the Wobblies still have Mars and until we dig them out of there there's no since in worrying about the rest."

**[Langer]:** "And we *will* dig them out of there, bet on that!"

**[Fairbanks]:** "Kicking and screaming, if we're lucky."

*[The trio grin at that comment as well]*

**[Bryson]:** "Thank you for your time, gentlemen. We wish you nothing but success."

—INN Broadcast Interview, Terra, 14 November 3078

**MARS: ASSAULT**

*[Video opens on a DropShip's briefing room, stuffed with officers from various commands. Standing at the head of the table is a tired and worn-looking older man with a general's pips. Behind him is a large geological map with the label "Koryo, Mars; 4 Jan 3056" in the top right corner. Redburn is looking down at the table, rifling through several flimsies.]*

**[Voice ID: James Bryson, INN]:** "You're currently looking at the camera feed from the Admiral's Briefing Room here on the Dulles Van Buren, enroute to Mars. General Redburn, whom you see at the head of the table, has allowed us to record the start of his preliminary briefing on the upcoming assault on Mars. And it looks as if he's ready to begin, so we'll join the conference now..."

**[Redburn]:** "...is a preliminary briefing to give a quick overview of the assault. We'll break down the operational steps in a moment; please note that this portion of the briefing is being recorded as per Devlin Stone's general order 212. Are there any questions at this time?" *[Redburn glances around the room, then nods.]* "Very well then. Lights."

*[The lights dim, the wall map brightens as Redburn steps to the left and begins gesturing with a laser pointer at various areas while he talks.]*

**[Redburn]:** "This is Koryo, our primary objective. As you can see, this map is over twenty years out of date. And that may be a huge problem."

"Our operational plan isn't complicated, people. We're going in fast, hot, and hard; the Blakists know we're coming and will be expecting us to land, establish a forward base, and conduct a slow assault."

"We're *not* doing that. We'll be dropping right on top of the Chryse Planitia, near three of Koryo's six entry locks. The Wolves-in-Exile and the Nova Cats, the Seventh Donegal and the Horses, and the Liberators will all hit separate locks and push into the dome as fast as possible. Because this is ROM headquarters, be prepared for anything, including false surrenders and sensor jamming."

"The biggest crack in our plan is the fact that our air support will be minimal. This is why quick penetration of the dome is critical. DropShips will not be able to ground near the dome"



## AFTERMATH

due to the limited space on the plateau, as you can see. We'll be providing as much overflight as possible, but fuel reserves will be low and not sustainable.

"Bottom line is, expect everything and assume nothing. Stone wants Mars quick and fast, so if we need to fight dirty to win... well, do it. I know that offends some of our Clanners' sensibilities, but all I can say is, 'get over it.'

"Okay. At this time, we'll cease recording and dive into the operational details." *[Redburn nods towards the camera. Static.]*

—INN Archival Vid, taken from on board the DropShip *Dulles Van Buren*, 17 November 3078

## MARS: VICTORY

(17 December 3078)

Mars [INN] — Organized resistance on Mars ended early morning 13 December, with the shattering of the Pullo aerodrome. The tragic loss of civilians at Pullo is one in a long list of atrocities

## COME HOME

The Master has fallen! St. Jamais has betrayed our trust! The promises of enlightenment that were made to us were no more than empty words to entice us to leave our homes and fight for their cause.

But I believe those words; I believe them now, as I believed them then. Our leaders may have failed us, but their ideals have not. The people of the Inner Sphere are happy to squat in the materialism, in their disdain for the greater good. They see the Word as nothing more than an adversary to be defeated. They do not realize that the Word is Faith, in acceptance.

We, the Faithful know this. We have experienced the light of Blake lifting us from our lives of poverty and inconsequence. We have seen the changes that his Grace has wrought upon our brethren. And it is good.

So I, Precentor Sariana Pryor of the Twenty-fifth Division, put out this call to all Faithful:

Come home.

The Inner Sphere has abandoned us. They neither want nor deserve our assistance in changing their lives. Even our leaders succumbed to the temptations of the Sphere, and it tore their dreams apart.

Come home!

You know who I am, where I have come from—and what I have done. You know the strength of my Faith. If you share my dream of an enlightened future, of a society built upon the precepts of Faith and advancement of all, where materialism is unknown, and where only the truly Righteous will lead, then come home.

We will be waiting for you.

—Intercepted Transmission broadcast to every command in the Blake Protectorate, origin unverified, 21 December 3078

## CASE OF THE CLANS

(29 December 3078)

*[Orson Tanaka walks across a military base, a thin blond soldier in non-descript fatigues walking with him. Turning to the camera Tanaka addresses the audience]*

**[Tanaka]:** "I'm here in the city of Geneva on Terra. With me is Marshal Conner Sortek of the AFFS. Though, as I understand it, Marshal, you have just resigned your commission to help Stone with restoring order to Terra, so should I call you General?"

**[Sortek]:** "Why don't we just settle for Conner?"

**[Tanaka]:** "Thank you, Conner. Something that has us all scratching our heads, with all that the Word still had on Terra, why were no Clans present?"

**[Sortek]:** *[Sortek chuckles lightly]* "Well Orson, I'd say that's pretty simple. You see we just finished fighting a bloody no-holds barred war for Terra. I don't think the Firs—ah, Precentor Martial really wanted to see us repeat it all over again."

**[Tanaka]:** "So the rumors are true, it was Victor Steiner-Davion who was responsible for depriving the Coalition of the Clans forces. Why is that?"

**[Sortek]:** "It wasn't 'depriving' us; it was preventing us from being in a whole new all-out war right after the victory here. Terra is to the Clans what Vatican City is to Catholics. Even we New Avalon Catholics would do anything to visit. But with the Clans, their idea of a 'visit' is a throw down to see who can be 'King of the Hill'. Their Crusade may be technically over, but Terra remains their ultimate prize and the Clan who wins it gets to become the 'ilClan' as they reckon it."

**[Tanaka]:** "So, you're saying Davion did it to keep the Clans from fighting over Terra? Wasn't that a bit risky?"

**[Sortek]:** *[Sortek shrugs]* "Hell, assaulting Terra's only been done once before and they had hundreds of WarShips. I'd say pretty much end-to-end what we just *did* was risky. Devlin Stone and the Precentor Martial made a tough call, but we're here and the Word isn't, so I'd say it wasn't half bad."

**[Tanaka]:** "I see. Well then, why Precentor Martial Davion? Wasn't it Stone who brought the Clans into the Coalition in the first place?"

**[Sortek]:** "Well I wouldn't call it 'brought', more like he got them pointed in the same direction as the rest of us. Hell, the Bears never really did operate *with* us, and they damn near ruined a couple critical ops along the way. But you asked 'why Victor'? Stone may have beat the Bears on Tukayyid for use of the HPG, and the Nova Cats may have had a vision, but the Falcons and Wolves were just in a race to see who'd land on Terra first. In the end, Stone was still just directing all of that fury, but when it comes to asking? The Precentor Martial is one of only two men who has ever fought the entire Clan juggernaut to a standstill. Who else would *you* have thought they'd respect?"

## AFTERMATH



inflicted upon mankind in this war, and it is disturbing that the nearly 12,000 lost are no doubt too few in numbers to warrant much attention from a war-weary Inner Sphere.

Then yesterday, the highest-ranking Blakist officer, one Demi-Precentor Lawrence Stevenson, formally surrendered to General Redburn at Koryo.

The campaign for Mars has been notable for its lethality. Largely executed by the forces of three Clans, as well as Stone's Liberators and the Seventh Donegal Guards, statistics may show that Mars yielded the lowest number of Blakist prisoners. The fighting in numerous habitats was literally room-to-room, with Clan Elemental, Gnome and Golem battle armor assaulting Blakist strong points with abandon.

By all accounts, the fight for Mars could have been concluded much sooner; Coalition forces massively outnumbered the Blakists in almost every instance where fighting took place. But the serious lack of aerospace superiority has hindered their ability to deploy. This stalled General Redburn numerous times, despite the best efforts of Clan fighters involved.

While the Word of Blake may no longer control Mars, it is clear that peace may yet be far in the future for its populace. It appears many Martians actually preferred the Word's regime here and see the allied Coalition as an invasion force. Just this morning, I saw a man paint "Free Mars!" on a building opposite a Nova Cat barracks.

### CORPORATE CHAOS

(2 January 3079)

Donegal [DBC] – Welcome to our special "Terran" edition of our year's end fiscal review. So soon, you say? The early bird catches the worm! Too little, too late, you say? Well, there still is the current matter of a blackout and ongoing fighting that require the early bird to have steel feathers and an iron stomach...

For the last twenty years, Terra's weapons industry was controlled exclusively by the Word of Blake. For the couple of centuries before that, it was ComStar's plaything. But now it's finally all on the open market: A huge treasure chest, showing off its jewels for all to see. Apart from the obvious high technology and the amazing output, who knows what these gems can yield for the savvy investor? The sky could well be the limit.

Of course, offsetting this is the fact that the treasure chest is broken: Practically all of the major manufacturing lines have been destroyed, sabotaged, or otherwise crippled. Consider the partial butcher's bill here:

Skobel – Ruins.

Krupps – Leveled.

Martinson – Burned.

Mitchell – Gassed.

The O'Neil yards – Yeah, let's not talk about that...

To sum it up: Terra is a gamble, no matter how you slice it. The

opportunities are *huge*, but so are the chances to fail. In every case, you'll need lots of money—assuming the Coalition and ComStar don't press a claim first.

Now, there are already rumors about several Terran boards of directors suing the Coalition for reparation damages. But while the Gibson Federated case stands a good chance of being laughed at, other lawsuits may not be so easily discarded. Stone's war band wore the mantle of justice too long to switch back to petty plundering. They have a responsibility now, to treat everyone fair.

Now, the bottom line here is simple: Whatever you plan to do, do it fast, or this large, juicy worm will be gone. Don't say we warned you.

### SEVERE DATA LOSS POSSIBLY WIDESPREAD

(2 January 3079)

Terra [ISNS] – It's been a long time since Adept Phillip MacKezy has been this stumped by a computer. "To be honest, I'm not even sure one of ComStar's old mantras could even bring this thing back to life," said MacKezy, standing by one of the large data storage towers deep within the Amazonian Castle Brian complex. The fortress was the key component in the Word's SDS network and was captured by Coalition forces led by FedSuns Marshal Jon Davion. "Right now, what you're looking at is a quarter-ton paperweight, rather than a sophisticated data network and relay processor."

The problem is that, according to MacKezy, the technologically advanced DNRP "just quit working" in early December. MacKezy was one of two on the Precentor Martial's staff assigned to catalogue and disseminate the information held within the DNRP's hundred-yottabyte (YB) storage centers. "The amount of material in this thing is amazing," he said. "Stuff that could advance the Inner Sphere into a new golden renaissance of information."

Now? "It's just a nifty piece of scrap metal."

MacKezy's situation is not unique. Reports trickling in from across the Terran system indicate that several other data storage centers like the one in Rio have gone completely offline; most have had their data irrevocably lost or deleted—and not by the actions of Coalition forces.

"I can't confirm that," replied the Precentor Martial when he was asked recently during a tour of the damaged Krupps Armaments facility outside Budapest. "It's going to take years before all the data we've collected from the Word's archives are properly sorted and distributed, so it's pretty premature to suggest the Word went into some sort of data suicide mode."

Yet it's not just the Terran network that seems compromised. Independent reports and rumors from several other former Protectorate worlds indicate that vital system networks, HPG relays, and other important technological data have been corrupted or otherwise lost. In at least four cases, the data loss



AFTERMATH 

was so severe that some infrastructure had to be shut down or curtailed due to malfunction errors and other system failures. Reports continue to trickle in and seem to indicate a much larger problem exists than what Stone's council is willing to admit.

"Combat causes collateral damage, unfortunately," said Adept MacKezy. "It's quite possible, with all of the hard fighting over the last several years, that we're seeing the end results just catch up to us."

WHAT'S REALLY HAPPENED ON HILTON HEAD? 

*[Vid-screen begins promo with music]*

**[Announcer]:** "And now, *Inner Sphere Conspiracies: Truth or Myth*, with your host, Viktor Chandler."

*[Applause; video reveals a middle-aged, balding and overweight man dressed in a fine-cut, stylish suit and sporting an oiled Vandyke beard cut to a point. He sits at the head of a semi-circle table with two women and a man.]*

**[Victor Chandler]:** "Welcome back to another edition of *Inner Sphere Conspiracies: Truth or Myth*. Today is January 12, and I'm Viktor Chandler. Tonight, we welcome back our special panel to discuss the recent fighting for Terra. In a battle so rife with oddities, perhaps none are stranger than the collapse of Hilton Head island, the long-time bastion of ComStar and its Word of Blake successors.

"Tracy Melbourne, welcome back. What do you know about the events at Hilton Head?"

**[Melbourne]:** "Well, Viktor, I have it on good authority that one of the Coalition

WarShips kamikazed into the complex. Though it sounds extreme, desperate, and pretty much insane, this action was likely necessary to destroy the complex before it launched an estimated one-thousand ICBMs against the Coalition and its attendant space forces."

**[Chandler]:** "Remarkable!" *[Turning to another panel member—a fair-skinned man with jet-black hair, wearing gothic make-up and a red jumpsuit.]* "Antoine Schlessinger, thank you for joining us again. What do your sources tell you?"

**[Schlessinger]:** "Thanks, Viktor. My sources apparently contradict Tracy's information." *[Melbourne arches an eyebrow, but otherwise seems unfazed. Schlessinger ignores this.]* "My informant claims that he overheard two officers describing that a massive laser weapon found on the Lunar surface was fired by Coalition forces to destroy the Hilton Head facilities."

**[Chandler]:** "Now that seems quite a bit far-fetched, don't you think?" *[He turns to the sharp-dressed final panel member,*

*even as Schlessinger seems ready to protest.]* "And, Jessica Cynella, thank you for coming. Do you have a theory here?"

**[Cynella]:** "I do indeed, Viktor. I have confirmed information of which the veracity is unimpeachable."

**[Melbourne]:** *[Scoffs]* "As always..."

**[Viktor]:** *[Waves down Melbourne and Schlessinger]* "Well, then?"

**[Cynella]:** "My sources tell me that Precentor Lucifer, the rogue Manei Domini who sided with Cameron St. Jamais, actually detonated Hilton Head's subterranean nuclear weapons stockpile in an desperate bid to prevent another Manei Domini—Precentor Azrael—from enacting a devastating scorched earth plan across Terra itself."

**[Melbourne]:** "Are you freaking serious? You're telling me the capital of the Word of Blake went nuclear over a cyborg catfight?"

*[Before Cynella can answer, Melbourne and Chandler jump in, and the panel devolves into arguments as the network cuts to a commercial.]*



TOURING TERRA





## TOURING TERRA

*Homo sapiens sapiens* left its homeworld for the first time on 12 April 1961, when “cosmonaut” Yuri Gagarin launched from the Baykonur spaceport in Vostok 1. Not quite 150 years later, *TAS Pathfinder* made the first hyperspace interstellar transit to Tau Ceti on 5 December 2108. Engineer Michelle Land of the Terran Alliance member-state “Canada” became the first human to set foot on a world outside the Terran system on 15 December 2108, when she stepped out of one of *Pathfinder’s* excursion vehicles onto the world that would soon be officially named “New Earth.”

In the subsequent 970 years, the literary cliché would be, “and mankind never looked back.” Essentially every human who has ever lived has been born since *Pathfinder* made its historic jump, and virtually all of them were not born on humanity’s homeworld, Terra. Amongst the teeming trillions that fill the Inner Sphere and spill into the unmapped, endless reaches of the Periphery, the population of Terra—now and all that lived in the past—is so trivial that it is lost in the statistical noise of census errors. After the collapse of the first Star League until perhaps the beginning of this blighted Jihad, the average human would think of Terra as being no more than a sacred homeworld, a living museum of

past cultures—if they thought of Terra at all. This is a shame, because very little of what we do today is free from the touch of Terra.

Most obviously, humanity was born and evolved on Terra. Two hundred and fifty thousand years ago (give or take some tens of millennia), modern humanity differentiated itself from its parent species. (Readers will have to forgive me if I do not recognize James’ McKenna’s “*homo stellaris*” as different from *homo sapiens sapiens*. JumpShips, a few genetic vaccines, and a pretty speech do not a new species make.) You are reading this document now because of that event, and all the events that shaped Terra before then.

There are more immediate signs of Terra in your life than Terran-born ancestors, who may be up to 962 years in your past (as marked by the founding of the New Earth colony in 2116). Virtually all of the technology around you was originally developed on Terra: fire, stoneshaping, wheels, gunpowder, steam and combustion engines, flight, nuclear power and nuclear weapons, electronics and computers, spaceflight, lasers, hyperspace travel, BattleMechs, WarShips, and more. Certainly many technologies have been refined by other planets, and some later technologies like BattleMechs

were supported by major research centers on a dozen worlds, but it would be hard to find a technology that was not first brought to fruition (and often to a high level of perfection) on Terra.

Terra might have seemingly slipped into obscurity three centuries ago when the first Star League fell, but this is not entirely the case. As a seat of empires, Terra has set in motion events occurring even today. The Succession Wars were, by the definition of historians, wars fought over the succession to the throne of the Star League, a Terran-based empire. This “Jihad” of the Word of Blake was likewise motivated by a vision of a humanity reunited under a Star League. Clans, Houses, realms in the Periphery—all are touched daily by events started on Terra or revolving around Terra.

For all of its influence then and now, modern Terra has remained largely hidden behind ComStar’s cloak of mystery. ComStar did take steps to open Terra to the Inner Sphere in the 3050s, but the information made available in wide distribution publications like ComStar’s autobiographical *ComStar Sourcebook* was condensed and abbreviated. Here, I hope to provide considerably more insight to mankind’s homeworld for the allied forces who will soon be liberating it.

—Bertram Habeas, 6 January 3078

## TERRAN HISTORY

Depending on how far one regresses, significant moments in Terran history could be traced back to the DeBurke Instability that led to the “Big Bang” and thus the creation of this universe. (Tracing further back than the Big Bang gets a bit pointless for anyone but physicists, who have the necessary specialized terminology to describe what to anyone else, including this historian, was basically “without form, and void.”) There are endless other significant moments in history where a historian could say, “Without this event, modern civilization would be completely different than we know it.” However, Terran history begins becoming truly relevant to the Inner Sphere is at the end of the Second Millennium, the twentieth century.

[Readers are recommended to acquire a map of Terra for the following discussion, as it will refer to Terran geography more than you ever wanted to hear after leaving secondary schooling.]

## THE TWENTIETH CENTURY

At the dawn of the twentieth century, human civilization was reaching a point not too different from our own. Admittedly, the majority of the human population were subsistence-level farmers who had never seen a steam engine or heard of electricity, but the advanced nations of Europe and the Americas had trains, powered ships, ground cars, lighter- and heavier-than-air flying vehicles, telecommunications that instantly spanned continents by cable and radio, and medical knowledge that was finally more likely to save you than kill you. In the early 1900s, these technologies would all have seemed incredibly crude to modern readers, but they were present. By the end of the century, mankind would have added electronic computers, spaceflight, and nuclear power to its toolbox (and armories).

The twentieth century is also notable for its political events. The century had barely begun before humanity turned its newly

## TOURING TERRA



developed industrial muscles into the first large industrialized war, retroactively dubbed, "World War One." (This name is misleading because global-scale conflicts had been waged previously in the Second Millennium, during the Age of Sail, but World War One was the first global war to be clearly defined as such.) The conflict featured, in crude forms, many of the military technologies we would be familiar with today, and introduced the tank and chemical warfare. It also featured unimaginable fatalities as armies trained to a prior century's tactics crashed into the weapons of a new era. The Battle of the Somme, from 1 July to 18 November 1916, exemplifies this: the battle claimed approximately 1.1 million casualties, 800 aircraft, and 100 tanks (which debuted in this battle) to allow the armies of France and Britain to penetrate only eleven kilometers into German lines. (The three-kilometer advance of the British was noted as costing two lives per centimeter.) Adept students of history should note this single battle generated a number of casualties equal to a fair percentage of the military casualties of the Fourth Succession War.

World War One continues to be studied in military academies around the Inner Sphere, often for its many examples of how *not* to fight a war against modern weapons. More importantly, though, World War One set up a chain of events that would lead to the Terran Alliance. It started the collapse of European powers and would lead to two unique military-technological races known as the Cold Wars that would, among other things, lead to space travel and fusion power plants.

Before those latter events could take place, though, the victorious nations imposed a crushing peace treaty on their defeated foes, heaping all blame for the war on Germany and its allies. Germany understandably had a different perspective on a war that it did not exactly start. After difficult reparations and a global economic depression, Germany was ripe for a demagogue, and got one, Adolph Hitler (a name that remains almost as recognizable today as "Genghis Khan," "Stefan Amaris" and "Jinjiro Kurita.") The war that Germany and its allies launched was eventually named "World War Two," and it ended the old world order. The scale of World War Two was even larger than World War One and, for modern readers under any misapprehensions about how savagely their ancestors on a single little planet could wage war, it was not until the Reunification War six centuries later that mankind would kill so many people in one war.

*[For those interested in the period, I would recommend Wars of One World, the 3002 multi-media work on Terra's World Wars, their genesis and their aftermath, edited by Thelos Auburn. These are the first wars for which mankind retain significant photographic and video data, which has been skillfully compiled in this encyclopedic review of the history, politics, and weapons of the World Wars.]*

The great European empires emerged from World War Two impoverished and bombed. Their *de jure* empires would collapse over the next two decades as subject states rebelled and voted their way to freedom while Germany was divided into two puppet

states by the victors, a situation that would not be repaired until 2014. The new order that emerged was dominated by the United States of America (USA) and Union of the Soviet Socialist Republics (USSR). The USSR had sustained over twenty million fatalities halting the German onslaught and then battering the invaders back to their capital, Berlin. The USSR also fought throughout Eastern Europe (containing Germany's wartime puppet-allies) and even invaded Germany's major ally, Japan, at the end of the war, establishing it as a military powerhouse. The USA simultaneously warred against Japan and Germany in two different hemispheres of Terra while its industry armed its allies (including the USSR) and its resources fed the allies' war machines. (Indeed, it was the US Navy that drove a Kuritan ancestor, Takeo Kurita, into a humiliating retreat before an inferior force.) The USA's scientists consumed enough resources in their successful effort to develop the first nuclear bomb to effectively constitute a third front in the war, and used the weapons twice to smash a defiant Japan into surrender. After the war, the USA and USSR were in positions to dictate the course of humanity's future, but they did not share goals.

The USSR's communist ideology had been at odds with the capitalist ideology of the USA before World War Two, but a common enemy had briefly united them. After the War, though, they had no checks and balances on their behavior as the European powers were waning. And certainly no one had anything like the USA's nuclear weapons (until USSR spies and scientists corrected that imbalance in merely four years.) For the next thirty years, these two nations manufactured tens of thousands of nuclear weapons and threatened to use them on each other in an apocalyptic World War Three should their sovereignty be significantly threatened by the other. In the Early Modern English of the era, the acronym "MAD" was coined for this standoff. MAD survives well into Star League Standard English today, meaning "Mutually Assured Destruction." The USA and USSR engaged in a dance of proxy conflicts, established *de facto* empires of allies and puppets, subverted efforts of governments that seemed likely to swing to one side or the other, and directly fought brushfire wars from the late 1940s until the middle 1980s. The period between World War Two (or, sometimes, the detonation of the USSR's first nuclear bomb) and the first collapse of the USSR is known as the "First Cold War."

Under competitive pressure and concerns about the other side gaining a foothold on "the high ground," both the USA and USSR leapt into space. (A due footnote: much of their early work was inspired by the German researchers and ballistic missiles used in late World War Two, and the USA's and USSR's first manned launchers were based on weapons designed to launch nuclear weapons between continents.) The USSR put the first human in orbit, Yuri Gagarin, while the USA put the first man on the Terra's moon Luna, Neil Armstrong. As the USSR's nuclear arsenal became large and accurate enough to threaten the USA, the USA began crash programs to develop anti-missile



## TOURING TERRA

weapons, like the Excalibur anti-missile laser satellites of 1985 and the supporting *Liberty*-class spaceplanes of 1988. Carrying the First Cold War into space while simultaneously building ever-more-advanced war machines on every continent of Terra was incredibly expensive. The American empire could draw upon the vast reserves (and loans) possible under capitalism to sustain this economic “stare down,” but the inanities of the Soviet empire’s communist economy led to the latter’s collapse in 1988. A non-Communist reformist government led by Mikhail Gorbachev came to power in Russia on 11 January 1988.

The informal American empire was not foolish. These nations recognized their one-time foe hosting relatively free elections and opening itself to much-needed trade in the late 1980s, so the USA and its North Atlantic Treaty Organization (NATO) allies promptly began culling their militaries, cutting taxes, and encouraging trade (which was needed, because the sudden drop in military spending triggered a global recession). The last of the great First Cold War space programs became Crippen Station, a plan to industrialize space and somehow justify the enormous sums spent on space development in civilian terms. (Other plans, like a plan to industrialize Luna, would have to wait until 2016 and the Western Alliance’s blessing.) The USSR, or briefly reduced from the union to just the Russian Federation, began withdrawing from its East European empire (the “Warsaw Pact”) and trying to build a capitalist economy. Its feeble efforts to maintain a semblance of foreign “power projection” only produced a steady flow of military casualties from such areas as the subjugated Afghan SSR.

The Russian reformists, however, were stymied by the global economic depression and the much more acute domestic depression. While the centrally planned communist economic system of the USSR had been inept, it had been organized and somewhat functional. The reformists had poorly implemented the best capitalist theories of self-organizing markets by eradicating the central planning agencies and allowing factories and markets to find their own suppliers and customers, a task at which they had no experience, resulting in a catastrophic economic collapse in Russia-nee-USSR. The collapse was so acute that the average lifespan of Russian males fell by thirty years in just five years, representing living conditions even worse than those of modern Clan civilians. In 1997, the reformists were overthrown by Communist hardliners (in their third coup attempt) who established the “Republic of Russia,” and re-asserted many of the economic and political controls of the old USSR. The Republic also sent its troops into the previously-abandoned Warsaw Pact countries, reforming the USSR. War with weakened NATO was only averted because Russia and its gun-point allies were still impoverished. Both sides settled instead for the Second Cold War.

Like Hitler’s Germany, Russia’s new government was driven to recover national pride with saber rattling. It rapidly rearmed (as best as it could afford) and made overtures to the Communist parties in Western Europe (who had gained footholds during the

economic depression of the 1990s), overtures which alarmed those nations. NATO increased its military spending in turn. Russia abandoned the “Republic of Russia” moniker for the old “USSR.” By 2004, World War Three looked very possible, and the militaries of both sides were modernized and enlarged from the 1990s nadir.

The situation was defused in 2004 by the ascension of Premier Oleg Tikonov. The “liberal” Tikonov has been lauded in centuries since—and even had an interstellar proto-state named after him—for his skill in defusing the international tensions, tempering the surging (and economy-breaking) Russian military, and opening relations with the West. While certainly a remarkable man who deserves a great deal of credit, Tikonov did not operate alone, nor did he become premier through personal empire building. After seven years of renewed Cold War tensions, most of the USSR’s leadership had come to realize the truth that reformists had figured out in the 1980s: the USSR was broke, its economy was in shambles, and but for its nuclear weapons its military was a paper tiger. Tikonov was tolerable enough to most of the Russian powerbrokers to be selected as premier.

Tikonov oversaw the steady reduction of tensions and repair of the USSR’s economy, culminating in the Tikonov Accords in January 2011. These Accords opened the USSR to financial assistance from the USA. Four hours later, Oleg Tikonov and his family were killed in his limousine by a bomb—not from Communist hardliners enraged at the much-needed Accords, but by a Muslim extremist named Mustafa Khemer Rhasori. While Tikonov was not killed by his own people, some were certainly willing to exploit the opportunity and a power struggle began immediately. Member-states of the USSR revolted, starting with the Ukraine. Sergei Tarantoff, head of the USSR’s security-spy agency, imposed martial law to prevent the USSR’s disintegration but his brutal tactics only served to ignite the Second Soviet Civil War.

The USSR’s massive military began warring with itself (split into liberal and conservative factions) and against the secessionist territories. After three years of watching the war escalate and threaten to spill into Europe and Asia, NATO intervened by liberating Poland and Czechoslovakia. NATO then sought to end the conflict by backing the Russian liberals with an invasion through the port-city of Riga in January of 2014. Conservative Soviet commanders panicked and launched a limited, pre-emptive nuclear strike on NATO bases (many close to European cities), but this was thwarted by the Western Orbital Defense Network (WODeN) controlled from Crippen Station. WODeN successfully shot down every missile launched, an action that proved critical for the survival of humanity by eliminating the need for a kneejerk nuclear-counterstrike that could have escalated into the long-anticipated nuclear World War Three. The NATO landings prompted the last large wet navy engagement in human history as the Soviet fleet attempted to block the amphibious landings in the Baltic Sea and Kola Peninsula. Over-zealous Soviet fleet

## TOURING TERRA



commanders destroyed the city of Riga with chemical weapons, an atrocity that destroyed the conservatives' support at home and abroad. The war was over in March of 2014, and more than 15 million Russian civilians were dead.

### WESTERN ALLIANCE

In the aftermath of the Second Soviet Civil War, the notoriously humorless Prime Minister of Britain Boris Johnson issued an uncharacteristically impassioned speech that called for, "a new alliance of Western nations." The concept would unite the European Common Market, the Free Trade Zone of the Americas (FTZA), and NATO in the hopes of avoiding economic and political turmoil of the sort that had crippled the world for the past three decades. These current organizations and others (like the "International Monetary Fund" and the powerless global mediator, the "United Nations") had failed in general, but had the local successes that suggested a more encompassing organization might avoid another "wasted generation." The solution, proposed by the best political and economic minds in the USA and Europe, was the Western Alliance.

The Western Alliance was (originally) an economic organization with policy set by a parliament, the parliament in turn granting fair and balanced franchise to each member-state according to a formula based on a nation's resources, industrial output, and potential for development. Most potential members viewed it as a fair way to combine developed and undeveloped nations into one economic organization without the latter becoming the puppets of the former. Poor nations were especially supportive of the plan. It would be headquartered in the city of Geneva, in the neutral nation Switzerland. The Western Alliance would also have a small "reaction force," the Western Alliance Armed Forces. Unlike international armed forces in the past (NATO, in particular), the WAAF would have a single command structure, a truly unified set of equipment, and would answer only to the Western Alliance Parliament (which, in turn, answered to the various member-states.)

Leaders of the various interested nations met in the newly reunited German city of Berlin in 2014 to hammer out the details. The ailing European Common Market and now-rudderless NATO (which no longer had its Soviet foil) were dissolved and incorporated into the Alliance. The seven independent Russian states that came out of the Second Soviet Civil War joined with probationary status, with full status available within a decade.

While it's brightest minds and leaders were responsible for designing and encouraging the formation of the Western Alliance, the USA as a whole evinced wariness. The USA's business community—note the USA represented fully a third of Terra's gross economic product at the time, and its economy was twice as large as the next largest economy, China—was generally approving of the Alliance, as it had been of FTZA. However, the USA's population was staunchly nationalistic, independent-minded, and isolationist

(to the extent the USA was the last major nation to enter both World Wars), and its conservatives thought ill (to put it mildly) of the idea of joining the Western Alliance despite the power America would wield in the Alliance.

At some point, Europe and pro-Alliance Americans hit upon the argument that failing to join the Western Alliance would mean the USA would suffer trade restrictions, loss of jobs, etc. (an argument always contrasted with the economic benefits of joining the Alliance). True, FTZA would be ended by the formation of the Alliance and the Alliance states might restore some level of tariffs on American goods, but ComStar's oft-repeated claim that the Western Alliance threatened a total embargo on American goods seems at best taken out of context (the claim primarily existed in anti-Alliance *American* propaganda, and secondarily in carefully couched responses to American politicians who threatened to completely embargo the new Alliance) and at worst a fabrication (as it was obvious at the time that such a total embargo to coerce American into the Alliance would produce exactly the opposite response. Even casual students of economics will also note the folly of embargoing a single economy as large as the rest of the original Western Alliance combined.)

The USA did join the Western Alliance in 2015, and after the Alliance worked through some hiccups and economic adjustments to newly-free trade, it worked well (even if, contrary to its more ardent supporters, mana did not rain from the heavens and streets were not immediately paved with gold.)

### The Alliance's Test of Fire

The WAAF (aided by sizable "loaner units" from member-state militaries) soon proved itself in 2023 by staring down China when that fledgling superpower attempted to force Japan (Terra's third largest economy) into joining the "Asian Co-Prosperity Sphere (ACPS)." (Readers should note the historical irony of China's effort, given Japan's brutal attempt to force China into the "Greater East Asian Co-Prosperity Sphere" eighty years previously.)

The Asian Co-Prosperity Sphere had been formed in 2022 by China, the Hong Kong Collective (soon to be "Hong Kong Free State"), and the recently reunited Korean states (which had been shattered in by USA-USSR maneuvering at the dawn of the First Cold War) as an effort to balance the growing clout of the Alliance. The instigations that led to the ACPS's creation were, basically, encirclement of China by the Alliance economically and geographically. In 2014, China's entire northern border consisted of Alliance probationary states, the various fragments of the USSR, and those held many of China's mineral suppliers. In 2019, the giant Republic of India (population 1.3 billion) to China's southwest joined the Alliance, and India was one of China's major trade partners. Securing Japan's economic muscle for the ACPS seemed critical.

China handled the matter poorly, though, turning a virtual propaganda bonanza over to the Alliance. The more radical



## TOURING TERRA

elements of China's leadership pushed for a dramatic blockade of Japan (an island nation poor in resources and agricultural land) in January of 2023 rather than diplomacy. And diplomacy might have worked—Japan's population was divided over joining the Alliance or ACPS. History would have been very different if a handful of China's leaders had been less brash; the Alliance might've faltered and withered away in the following decades without this proof of its ability. The radical Chinese leadership claimed the blockade would allow the ACPS to "better present its case to the Japanese people, free from the influence of Western venom-spreaders."

(How the ACPS would achieve this with a physical blockade when most Terran nations were linked together in an international computer network that compares well with post-Succession Wars planetary nets is not clear, but this quandary does illustrate that humanity then, as now, could use some of the most asinine excuses to justify conflicts.)

The WAAF started its standoff by delivering troops to Japan through China's blockade in a novel manner: the pen. With the USA's leave, American troops stationed in Japan (in bases the USA had established after subjugating Japan in World War Two) were "deputized" as WAAF units. This did not impress China, as it already factored in American saber rattling, so the Alliance turned to airlifts in April 2023 to relieve Japan's supply shortages. Unfortunately, the 125 million Japanese simply needed too many supplies for WAAF and chartered civilian aircraft to deliver, causing the pro-Alliance government of Japan to collapse and the Japanese Emperor to temporarily take control and impose rationing.

In May, the Western Alliance sent the first of several naval relief convoys to Japan. The ACPS refused to pass the civilian convoy, leading to a short conflict. The Chinese cruiser *Iron Flower* ran over the surfaced USS *Bremerton*, a *Sea Wolf*-class fission-powered submarine. Two Japanese Defense Force (JDF) destroyers, the *Akagi* and *Kongo*, invoked their neutrality during an attempt to rescue the *Bremerton*, but were instead engaged by the *Iron Flower*. The *Iron Flower* was eventually sunk, but not before it dispatched the foundering *Bremerton* (lost with all hands) and crippled the *Akagi* such that it later had to be scuttled. The *Iron Flower*'s aggression toward Japanese ships on a rescue mission (a point the *Akagi* and *Kongo* had broadcast loudly before moving toward the *Bremerton*) firmly swung Japanese opinion against the ACPS. The Emperor rescinded the JDF's strict rules of engagement so quickly that JDF essentially achieved complete tactical surprise against blockading ACPS ships, which suffered heavy losses. The relief convoy reached Tokyo Harbor, and WAAF forces in the Free Russian States and India went to alert in anticipation of Chinese attacks—conventional or nuclear.

Instead of nuclear Armageddon, Japanese diplomacy carried the day, and with far greater results than could be imagined a few months earlier. In 2024, the Osaka Agreement allowed Japan, Korea, and China to join the Western Alliance. Key elements of the Osaka Agreement included some guaranteed autonomy to

sort out regional international disputes without Alliance input (a change previously sought by many Alliance members), and a modification to voting rights in the Western Alliance Parliament that granted more weight to a nation's population (a change that secured China's agreement, but was also heavily favored by the next two most populous Terran nations of the era, India and America). Of the ACPS states, only the Hong Kong Collective remained aloof from the Alliance. The reason for the change had to do with internal purges in China. The large number of moderates in China was outraged at the loss of face that China had suffered at the hands of few foolish radicals. These radicals served as handy scapegoats for domestic purposes, but left China politically wide open to the generous admission deals offered by the Alliance. China could have all the economic benefits it sought in the ACPS, and with considerable power over the Alliance. It accepted.

**Science!**

As a government (or international alliance), the Western Alliance (and its Terran Alliance successor) focused on scientific development in a way probably never seen before or since. During the Cold Wars, the USA and USSR had the pragmatic goals of (respectively) "defeating the Godless Commie hordes" and "defeating the Imperialist Capitalist swine," but the Western Alliance invested heavily in pure research and practical development without any such national defense motivations.

The Alliance operated under the firm theory that such research would bring huge returns on investment and based their arguments on twentieth century history, when pure research had delivered all manner of practical technologies, either directly or by accident. (Fusion research, for example, would accidentally deliver data that led to Thomas Kearny's and Takayoshi Fuchida's insights of hyperspace.) This thinking may seem like a leap of faith, but many of the Alliance's leaders had seen the Cold Wars deliver astounding technologies. Their faith was well-rewarded.

Starting from Second Cold War crash-programs of Western nations to gain energy independence (Europe and the Americas often depended on imported petrochemicals), the Western Alliance continued to fund several competing lines of fusion research. A team consisting of researchers from Harvard University and Massachusetts Institute of Technology, aided by the General Motors (likely the same GM that puts BattleMechs in your House's army and cars in garages on a thousand worlds, if you believe GM of Kathil's legal claims), had a breakthrough in 2020 when they demonstrated the first full-scale fusion reactor with sustained net electrical production. The prototype's design was so successful that a commercial version was patented by GM in the next year. After the 2023 ACPS blockade, Japan would be an enthusiastic adopter of the reactors for electrical generation, while the Alliance Space Command (founded in 2016) would quickly turn the reactors into propulsion systems by demonstrating the first working fusion rocket in April 2026. The first manned fusion spacecraft,

## TOURING TERRA



the *AS Columbia*, made its maiden flight to Mars on 12 October 2027, and it was shortly followed by the unmanned *Magellan* slower-than-light interstellar probes in 2029. Fusion power would be critical to reducing Terra's problems with pollution and resource consumption, greatly easing mankind's impact on Terra's environment by the dawn of the twenty-second century. Under Western Alliance incentives, fusion power quickly replaced coal-fired power plants, Terra's primary power source at the time. New applications for inexpensive fusion heat and electricity, like desalination, hydrogen production (mated to breakthroughs in simple hydrogen storage), steelmaking, cement kiln heating, and recycling, also replaced more wasteful technologies. The technologies resource-starved Terra developed in the twenty-first century are still used on resource-poor worlds throughout the Inner Sphere.

In the late 2070s, steady refinements on fusion technology resulted in several breakthroughs in reaction catalysis that made net power production from fusing normal hydrogen, the protium isotope, possible. The reactors were more complicated than the conventional reactors of the era, which typically used various fuel combinations based on deuterium, tritium, and helium-3, but the savings on fuel made the new reactors more cost-effective in the long run. All modern reactors are descended from this breakthrough.

Medical knowledge leapt forward, building on the twentieth century's firm foundation. Several dread diseases that had, well, plagued humanity for millennia fell before the onslaught of Western Alliance medicine, like "malaria"—a disease the reader should consider referencing to see how its presence and absence shaped the industrialization and growth of nations in the late Second Millennium. The more recent scourge of "AIDS," an immune system-attacking virus that proliferated in the late twentieth century and stumped a global medical establishment used to rapid vaccine development, finally fell to Western Alliance researchers in 2026. The genetic vaccine against AIDS was a key instrument in luring African nations (which had catastrophic levels of infection) into the Western Alliance. With genetic vaccines steadily erasing inherited troubles and granting everyone healthy hearts and strong immune systems, average life spans in the Alliance began climbing from where they had leveled off in the twentieth century (in the mid-70s). In 2098, the Terran Alliance could honestly claim that the average lifespan of its citizens was over 100 years.

The Alliance also intensively developed space travel, though a return on investment was a long time in coming—and started the have/have-not grumbling amongst member-states that would plague the Alliance until its demise. One of the first great space projects of the Alliance was to settle and industrialize the moon. In the same year of its formation, the Alliance Space Command (ASC) was tasked to permanently settle Luna and did so. By the end of 2016, the ASC had put 112 scientists, engineers and technicians

on Luna as permanent residents. Luna seemed rich in helium-3, a potential fuel for primitive fusion reactors (though soon produced in larger quantities by tritium breeding); it had important defense possibilities against the Alliance's Asian rivals; it was relatively rich in metals and raw materials for spacecraft and space station construction; and its low gravity made it easier to access than Terra with the primitive chemical rockets of the day. Luna would support early exploration of the Terran system with its revolutionary, if small, aerospace industrial facilities, but Luna did not prosper as hoped. It was starved of light elements, especially hydrogen, and its low gravity was even less healthy than that of Mars, and fusion rockets would render its low gravity advantage moot by 2030. It was a critical, if expensive, part of the infrastructure that supported early manned exploration and settlement of the Terran system, supplying many of the structural components of large (for the time) spacecraft like the *Altair*-class transports and the *Magellan* interstellar probes.

The *AS Altair* and its sister-ship, the *AS Procyon*, began the first manned exploration of Mars, Terra IV, a planet mankind had—until the middle of the twentieth century—imagined might be habitable and, perhaps, inhabited. These chemically-powered vessels launched to Mars in July (*Altair*) and August (*Procyon*) of 2017, consuming thousands of tons of lunar oxygen and Terran hydrogen to lumber across a mere 0.5AU in six months.

Fusion revolutionized interplanetary travel. The fourth *Altair*-class transport, the *AS Columbia*, was refitted with a fusion engine. On 12 October 2027, the *Columbia* left Crippen station for its maiden voyage to Mars. It arrived on 26 October 2027, making the journey in just 1/12th the time of its previous, chemically-fueled voyages. The *AS Columbia* had hardly finished its voyage when it was being used to trumpet the potential of fusion-powered spaceflight. While ambitious Alliance member-states planned to mine the asteroid belt, scientists convinced the Western Alliance Parliament to fund the *Magellan* program. Authorized in 2028, the first of the giant, unmanned *Magellan* probes was launched in 2029. Over 300 meters long and consuming more than 30,000 tons of liquid hydrogen accelerating to and braking from 68 percent of light speed, eight of these giants would explore seven nearby systems. (*Magellan Six* failed to decelerate and was long considered lost.) They were targeted at star systems that giant, space-based telescopes had suggested had worlds in habitable zones, resulting in the high success rate of the *Magellan* probes: Tau Ceti (known today as New Earth), Epsilon Indi, and Epsilon Eridani.

(Interestingly, new evidence has come to light that *Magellan Six* and *Nine* were manned with American super-nationalists seeking to escape "Alliance tyranny," and *Magellan Six* survived to reach an uninhabitable star system near Terra in 2119—years after the Alliance beat them to the stars with the Kearny-Fuchida hyperdrive. Unfortunately, contact with the rumored "*Columbia*" system is only maintained by the insular and uncommunicative





## TOURING TERRA

Terran Belters, who might simply be having fun at historians' expenses with the Columbia story.)

Terran hunger for mineral resources drove a group of North American and European investors to push for the exploration and settlement of Terra's asteroid belt (between Mars and Jupiter, Terra V). The first colony was established (by the USA) on the large "Main Belt" asteroid Metis, a 200-kilometer diameter lump of nickel-iron that seemed to be the core of a large, primordial asteroid that had lost its crust and mantle to a titanic collision. The amount of accessible metal in such an asteroid is hard to conceive, especially if you are on a world with waning mineral reserves. Metis alone could have fed all of the modern Inner Sphere's industrial needs for tens of millennia. In the twenty-first century, mankind was willing to pay for the expense of milli-G, vacuum mining and interplanetary shipping to replace Terra's depleted reserves. Metis and other asteroid colonies boomed for a century and more. These boundless, if somewhat expensive, resources fed Terran industries. The zero-G environment led to industrial breakthroughs, like construction of much smaller fusion reactors and (in the twenty-second century) huge cost reductions in casting Kearny-Fuchida drive cores.

Seemingly stranded within the Terran system and riding on a wave of scientific successes, the Western Alliance (soon to be Terran Alliance) spent much of the end of the twenty-first century studying Terra's neighboring planets, Venus and Mars, for their terraforming potential (ignoring the "Belters" who said mankind should give up deep gravity wells and limited real estate for the boundless resources of the asteroids). The Terran Alliance would carry this to fruition with Project Aphrodite (terraforming Venus) and Project Lowell (terraforming Mars). While both were triumphs in planetary engineering that would give mankind the ability to moderate the many semi-habitable worlds found in the Inner Sphere, the two projects involved engineering on a scale never seen before or since. Venus had far too much atmosphere, an atmospheric mass most easily described with double-digit exponents, which needed to be sequestered by calcium injections from Mercury and hydrocarbons from Titan; Venus also needed its spin increased dramatically to have a sensible day length; Mars needed huge amounts of oxygen and nitrogen; and both worlds needed water in huge quantities. Very few later terraforming projects ever came close to matching the efforts wrought in the Terran system, and by the time Venus and Mars were habitable (by the early 2200s), they were "obsolete." Over one hundred habitable worlds had been found outside the Terran system and settled by 2172.

And those worlds were settled thanks to the Kearny-Fuchida hyperdrive. Though Kearny and Fuchida had died scorned and discredited, the Universities of Auckland and Ottawa independently rediscovered and proved Kearny and Fuchida's "Pan-Dimensional Gravitational Mathematics," announcing their confirmations within twenty-four hours of each other on 25 May

2102. (Interestingly, a Marik ancestor, Marshik Marik, missed a chance for fame here. His high energy physics team at the Czech Technical University published validation of the Kearny-Fuchida equations fourth, releasing their papers twenty-six minutes after their Cambridge rivals.) After fourteen months of debate, the Terran Alliance Parliament agreed to fund the "Deimos Project," a crash-program that strained Alliance unity with its enormous cost. The unity was also strained by the repeal of tax breaks on the poorer, less developed nations of Terra to fund the Deimos Project. While their contribution covered only a fraction of the Deimos Project's overall cost, it was a disproportionate burden compared to their gross domestic products and seemed entirely like bullying by the rich nations. The unrest settled when the Deimos project produced success after success (first unmanned jump: 0000 hours GMT, 3 September 2107; first manned jump: February 2108 by Raymond Bache; first interstellar manned jump: 5 December 2108 by the *TAS Pathfinder*) and revealed the quintessential garden colony: Tau Ceti IV, soon to be renamed New Earth. The domestic quiet, though, did not last long.

### THE TERRAN ALLIANCE: A TROUBLED GOLDEN AGE

In 2086, the Western Alliance took stock of itself and noted that over 120 of Terra's nations and 80 percent of the planet's 9 billion people were under its banner. In recognition of this, the Western Alliance renamed itself the Terran Alliance.

The Alliance had fair reasons to be proud of itself in 2086. Since the Osaka Agreement, there had been no significant wars (defined as disrupting the global economy; three genocidal civil wars in Africa and Indonesia killing a total of eleven million people had occurred between 2034 and 2077). Thanks to fusion power and attendant technologies, crippling smog and pollution had disappeared. Polluted land and water were being steadily purified and restored. The global economy had been growing for thirty-seven unbroken years (four recessions in that period had brought growth to almost zero, but not quite—enough for politicians to pat themselves and bankers on their backs). Resources imported from the remainder of the Terran system had first ended shortages in rare minerals (like iridium and rhenium) and, by 2086, were supplying more common materials like lead and titanium. Medical breakthroughs were eradicating diseases, extending lives, and improving quality of life—the saying of the time was, "Sixty is the new forty" (which goes to show how short lives were in the twentieth century and preceding eras.)

Yes, the newly dubbed Terran Alliance had *reasons* to be proud, but it wasn't proud.

The easiest way to describe the problem is to say that the Western/Terran Alliance was just that: an alliance, not a nation. While it would later act much like a nation, in 2086 it was simply a powerful economic and diplomatic organization whose member-nations were firmly, sometimes rabidly, insistent of their sovereignty. The handful of wealthy, populous nations that

## TOURING TERRA



dominated the Alliance only did so out of strong self-interest—improved trade, national security, and improved ability to manipulate other member-nations. They and their citizens had no loyalty to the Alliance.

And if one asked a person on the street their citizenship, they were far more likely to name their member-nation than the Alliance. The huge spending going into science and research seemed to produce little immediate benefits. Standards of living only crept upward while the supposedly-minimal Alliance taxation rose much faster. Inhabitants of rich nations decried their money going to support “listless welfare leeches” in poor nations, particularly when such welfare spending was not part of the Alliance’s trade-and-international-arbitration mandate. Inhabitants of poor nations decried the selfishness of rich nations, who were so reluctant to share the pinnacles that could greatly improve lives in the poor nations with clinics, schools, and business investment. Dominated by rich nations, the Alliance issued rarely more than wrist-slaps for the “illegal” agricultural and industrial subsidies that protected the farms and factories of rich nations from competition by poorer member-nations.

The Osaka Agreement’s fundamental change from a relatively balanced membership to one favoring, basically, national wealth also put many smaller nations at a disadvantage. In response to complaints, formulas for representation in the Alliance Parliament continued to evolve and change until they were incredibly convoluted—but the end result was the same. Big population and high per capita wealth equaled clout. Member-states who did not like this arrangement could leave, but by the 2080s the Terran Alliance was arrogant enough to immediately impose trade barriers on recently seceded nations. It also often pressured non-members into joining through trade barriers and a constant stream of propaganda.

All these factors, of course, engendered unrest. In hindsight, it seems amazing that people who generally had such good lives (and ones that were improving steadily) could find reason to grumble; there are literally trillions of people in the Inner Sphere whose lives would be bettered if they could be dropped into the twenty-first or twenty-second century Terran Alliance. But they grumbled, and they fought, and they turned to terrorism. A 150-year stretch of peace and prosperity starting in 2025 was perceived by most who lived in the period as one of unease and fear, Alliance oppression in the name of halting terrorism and war, and economic dislocation as the Alliance favored rich nations over the poor. About the only subperiod that seemed relatively calm and cemented the Alliance was between 2025 and 2098. But after 2098, insurrections and terrorism seemed to be daily problems (even if, objectively, they were not).

The first clear indication of trouble came in July 2098, when Brazilian electronics factory workers revolted against their “conditions of slavery.” (The Brazilians “slaved” through a 35-hour work week in an era when most Alliance member-states had 30-

hour work weeks.) The problem escalated beyond the ability of Brazil to handle the matter. Or, rather, beyond the willingness of Brazilian leaders to handle the problem—those workers were their voters and taxpayers. The Terran Alliance reluctantly dispatched two TAAF divisions under the command of Major General Leonard McKenna to end the rioting.

The problems worsened five years later when the Terran Alliance approved the Deimos Project (by three votes) at ruinous expense. Taxes were raised sharply on a flat per capita basis—meaning poor nations with populations shouldered a disproportionately large share of the cost, while the club of wealthy nations that ran the Alliance barely felt the expense. Eighteen member-nations withdrew from the Alliance during the Deimos Project to avoid the tax burden, while others—like the moderately rich and quite populous Brazil - threatened to withhold monies for non-domestic spending.

The success of the Deimos Project quieted some of the unrest, but internal troubles were not the only ones that plagued the Terran Alliance. A planet’s worth of people, about two billion, lived beyond the borders of the Alliance. Living almost entirely in undeveloped nations (with a few exceptions like the wealthy Hong Kong Free State), most of them would have benefitted from joining the Alliance, but the unrest in Terran Alliance’s poor states made them wary of the “servitude” they might face if they joined. The Alliance squandered goodwill by imposing trade barriers and tolerating industrial and agricultural subsidies in its richer states, which left the non-Alliance states (soon dubbed “Separatists”) even less able to economically compete. Diplomatic friction became terrorism, brush wars, and embargos in the early twenty-second century. A constant threat was the widespread availability of nuclear weapons. Spreading education and technology meant that it was increasingly easy to build nuclear weapons, to the point nuclear grenades were a favorite of terrorists like Elias Liao in the 2180s, and the ever-present fear of nuclear weapons being smuggled into a major city led to the Alliance applying stricter security measures and garnering more authority over member-nations. It also led to wars against the Separatists. The Alliance wanted non-Alliance nations to remain free of nuclear arms, and it would conquer them to ensure this stayed true. The resulting wars were minor compared to the Second Soviet Civil War or the great World Wars of the twentieth century, but tens of thousands were killed and millions displaced by the encroaching Alliance forces.

Another motivator for the Alliance to secure all the separatists was the Kearny-Fuchida hyperdrive. Colonization through most of the twenty-second century had been slow, limited by the small shuttles, crude JumpShips, and few habitable planets known in the era. But the prices of JumpShips were plummeting thanks to the industrial developments in the Terran Asteroid Belt, habitable worlds were being found in increasing numbers, and the Ryan Cartel Iceships were opening previously-overlooked worlds to settlement. It was not out of the question, the Alliance realized



## TOURING TERRA

in the 2170s, that Separatists might flee to the stars and form interstellar nations that could rival the Alliance. That risk had to be ended, and was—brutally. By the twenty-third century, all of Terra was under the Alliance yoke.

With such a dismal perspective on the world around them, it was no wonder that billions fled Terra for the unknown amongst the stars.

### THE TERRAN ALLIANCE: PERVERSION AND DOWNFALL

There was no single event or individual that began eroding the Terran Alliance. And, ironically, the seeds of its downfall were often mistaken (at the time) for strengthening of the Alliance. For example, the twenty-second century troubles with terrorists and Separatists were answered by granting additional law enforcement and judicial powers to the Terran Alliance, eventually largely overriding member-state courts and civil rights. This caused unrest, though, since the Alliance's constitution only spelled out its role as a trade and diplomatic body and lacked any sort of civil rights protection typical of national constitutions. Such matters were originally left to the member-state governments, but those governments could now be overridden.

With growing authority, the Terran Alliance's parliament and civil service were no longer viewed as "second fiddle" to member-state governments. While there had been some notional Alliance Parliamentary political parties, they had little clout typically associated with political parties because the Alliance Parliament had been staffed with parliamentarians selected at the whims of member-state governments (rarely with direct input by member-state electorates). The Alliance was, to the perspective of member-states, simply an international organization to be staffed by junior diplomats (who, in turn, often vainly hoped time in the Alliance Parliament would lead to a better posting, perhaps as the head of an *important* embassy, or least an embassy in a nation with tropical beaches.) The Expansionists, which had seemingly dominated the Terran Alliance Parliament since the invention of the Kearny-Fuchida hyperdrive, were merely the mouthpieces for a group of like-minded member-states interested in settling the stars. It was not until the 2170s that the Alliance had accrued enough authority to begin dictating back to even major member-states.

And these Parliamentarians rarely answered directly to their electorates. In the self-avowedly democratic United States of America, for example, the Alliance Parliamentarians were directly appointed by the elected "President," the head of state and government, as he was the top diplomat of the nation. His appointments were approved by America's legislative body, its "Congress." The President and the "Senators" in Congress were elected officials representing millions of voters with diverse interests, so Alliance Parliamentarian appointments were some steps removed from the common American voter. And once appointed, the Alliance Parliamentarians were paid

and supported out of Alliance funds, which were dispersed by the Alliance Parliament, not the American public. Until 2207, those funds were "voluntary" taxes on Alliance member-states (who either paid up or lost Parliament seats), but—to continue the example of the USA—the taxes were only approved by the votes of the two-chamber Congress, which was open to extensive lobbying by the wealthy, political activist groups, and corporations. Thus, Alliance Parliamentarians were quite insulated from the interests of the public.

With new powers "to address the ongoing unrest and Separatists," the Terran Alliance saw a reversal of roles between the Alliance and member-state governments over the course of about a generation. By 2200, even wealthy member-states became somewhat junior partners to the Alliance, and local arms of Alliance political parties began supplanting member-state parties. These local branches gave some illusion of democracy in the Alliance, as they were usually directly elected to office and, in turn, selected the representatives that would go to the Alliance Parliament whenever the Alliance Parliament called for an "election." Some historians even argue that it is not clear that the Alliance Parliamentarians had the upper hand, since they were so dependent on appointment by local politicians, and could be recalled at any time. Instead, it's sometimes argued, the Alliance Parliament developed a more symbiotic relationship with member-state governments as they "scratched each other's backs." But one thing is certain: this new arrangement was even more divorced from the common man than before as Parliamentarians could manipulate local tax and voting laws to protect and aid their sponsoring member-state politicians.

Settlers on the interstellar colonies could have explained this matter to Terrans decades earlier. Since the Colonization Procedure Referendum of 2128, every colonial fleet had to be accompanied by a ship of the Terran Space Navy. And every colony was to be run by an Alliance-appointed governor. Many independent colonies and those of poorer Alliance member-states were completely subject to the whims of Geneva and the empire-building civil servants who oversaw the Alliance's interstellar colonies. (And these civil servants were appointed and hired by the Alliance Parliament, isolated from even member-state input.)

Those colonists voiced their displeasure with Terra's tyranny in the 2236 Outreaches Rebellion, which started with Denebola's declaration of independence. The Alliance Global Militia (AGM), however, was little more than a heavily armed police force (at this point, the member-states still held the bulk of Terra's military forces, and even those had withered away in a century of relative peace). The Alliance Marines were the only part of the AGM suited for an interstellar conflict, and they returned to Terra with their tails between their legs eighteen months after being deployed against the Secessionists.

Following the Outreaches Rebellion, the Alliance truly came to dominate life on Terra in a thoroughly unpleasant manner.

## TOURING TERRA



Emergency measures gave the Alliance power to regulate many aspects of life on Terra, while the insulated leadership exercised those powers without remove. As one contemporary political analyst noted, "The Terran Alliance has lost control of the stars, but its leaders are not about to lose control of Terra." When Expansionists dominated Parliament, they passed laws restricting creativity. Strict limitations were placed on artists (which was quickly expanded to include news reporters, eventually to many professionals like physicians and lawyers, and not a few classes of laborers). Restrictions included the number of hours an "artist" could work, rates for their works, and work quality. These restrictions were enforced by three separate Alliance agencies and the dread "artistic administrators," police with a black uniform not unlike those of Hitler's Germany. Liberals had their laws, too, many focused on controlling money through sharp devaluations (some applied to individual bank accounts of the wealthy who spoke against the Liberals) and restrictions on speech—for a while in the 2230s and 2240s, it was criminal to even mention offworld colonies. One of the Liberals' most infamous acts was to grant freedom to most colonies (whether they were ready for it or not), such that the Alliance was only 30 light-years across in 2242.

Criticism (and political assassination) eventually made it clear to the Alliance Parliament that change was needed, so the Alliance decided to make Terra a political paradise. Dissenters were given the freedom to leave Terra, and did so. In 2252, Liberals improved upon this Expansionist policy by actively assisting in the departure of dissidents whether the dissidents wanted to leave or not. By the 2300s, re-education camps and executions for political crimes were the norm; tens of thousands of Terrans were executed in the three years before McKenna's coup.

These policies, incidentally, robbed Terra of technological advances and its best and brightest minds. Research budgets were eliminated to fund mass production of colonial transports while vicious politics drove away scientists, doctors, artists, corporate managers, and even skilled administrators. While plenty of criticism can be leveled against the Terran Alliance administrators of the late twenty-second and early twenty-third centuries, they were well-intentioned and skilled. Their successors that followed the Outreaches Rebellion successors were corrupt, less intelligent, and less able, and resorted to oppression and violence to maintain their rule. Terra's brightest fled their madhouse home for the stars.

And while James McKenna is often credited for destroying the last vestiges of the pre-Alliance nation-states, he only made public what had been the de facto truth for three quarters of a century. The Terran Alliance never engendered patriotism, but the once-rabid devotion of Terrans to their member-states had waned as they failed to protect their citizens from the Alliance monster. Indeed, they became highly complicit with the Alliance's abuses. The giants like the United States of America and People's Republic of China individually held enough Parliamentary seats to block the downward spiral of the Alliance, but—for reasons I

enumerated above—their politicians worked hand-in-hand with their Parliamentary appointees to aggrandize themselves and exploit the vast power of the Terran Alliance. Three generations of that abuse destroyed any widespread vestige of member-state patriotism, so that McKenna's apparent erasure of member-states (turning them into provinces of a central planetary government) was met with little resistance and much acclaim. Visitors can still tour the one-time capital of America, Washington, and see White House Memorial, which praises the public lynching of the last American President and several Senators as a "liberation."

**TERRAN CIVIL WAR**

In all the corruption and political bloodshed of the Terran Alliance's last century, there was one pocket of stability: the Alliance Global Militia (AGM). The AGM sought to avoid the political turmoil of civilian life and gradually improve itself after the failures in the Outreaches Rebellion. Rather than risk a military coup (for the post-Outreach Rebellion Alliance government was too unsophisticated to imagine means of keeping the AGM loyal to civilian leadership other than bribery, and thus feared a coup), both Liberals and Expansionists funded the AGM as it requested. The AGM recovered its pride and fighting ability in the decades after Denebola. The AGM's neutrality and safety were recognized by the public to the point AGM recruiters turned away a majority of applicants, allowing the AGM to staff itself with superior personnel.

One such person was James McKenna, a Canadian from the still-wild Yukon Territories. McKenna was home schooled until age twelve, and when he entered formal schooling he showed immediate aptitudes for science and history. It was only when his test scores caught the eyes of the AGM that he considered military service (though his family had long produced soldiers for the Western and Terran Alliance). An AGM scholarship to the Annapolis Naval Academy in America and the fine education he could obtain from it finally convinced McKenna. At Annapolis (on the fringes of the Washington), McKenna balanced academic honors with threats of expulsion for his "exploration" of the debauched nightlife of the corrupt American capital. (The old joke about McKenna, the Senator, and the donkey is often excluded from McKenna's official biographies for two reasons: first, it's not a joke. Second, few historians—for some reason—want to discuss that McKenna used blackmail to stay in the Academy, even though they have no trouble talking about his military coup.)

Following graduation with honors, McKenna alternated exceptional performance in the line of duty with reductions in rank for bad conduct (five times in a decade). He settled down after this and rose to the rank of Fleet Admiral and took command of the Alliance navy in 2295. Admiral McKenna set about turning the Navy into a true fighting force rather than just troop transports for the Alliance Army by building the first proper jump-capable WarShips. The actions were questioned since, even at the dawn



## TOURING TERRA

of the twenty-fourth century and decades past the formation of the Free Worlds League, few Terrans could imagine more than one interstellar power. Essentially without oversight (and with plenty of support from Terran arms makers), McKenna pushed the project onward. *TAS Dreadnought* emerged from its slip for shakedown trials in 2300, followed by six sister ships and twenty escorts over the next fourteen years.

McKenna's ultimate plans were far from complete in 2314. Records made available from ComStar's archives during the 3052-3058 détente seem to suggest he was focused outward on "reclaiming Terra's errant flock" and anticipated another decade, at least, to be ready. Instead, though, politics on Terra went from crazy to raving insanity. The trigger point was the assassination of a minor politician, Grant Zoli, on 5 September 2314. Zoli's "People's Independence Party" was another flash-in-the-pan third party that garnered unusual support in its local branches from an apathetic populous, and was courted by both Liberals and Expansionists to form a ruling coalition in the pending Alliance Parliamentary election. Zoli toyed with offers from both parties until just before the election, and then committed to both (first Expansionists, then he withdrew his offer and sided with the Liberals a month later), and finally turned up dead under suspicious circumstances. This drove political tensions to a fever pitch; martial law was declared; the AGM had to be called in to put down rioting in Zoli's native New Zealand; and Liberals and Expansionists started fighting in the streets with private armies of thugs ("party security personnel.") Thousands of civilians were caught in the crossfire as the violence went on for months.

McKenna acted on 2 June 2315. He recalled all Alliance

WarShips and marines to the Terran system. He then demonstrated the firepower of his new fleet by vaporizing Strand Rock near Europe and another small island near Australia, and issued an ultimatum. For the Alliance politicians and their pet AGM units who refused to surrender, the guns of the Navy obliterated them or, if they hid amongst civilians, they were rooted out by Colonial Marines.

McKenna also called upon the AGM ground forces to quench the escalating violence, and the AGM agreed. The Battles of Zurich and Bangkok were the shining moments of the AGM ground forces in this civil war.

From aboard the *TAS Dreadnought*, Admiral McKenna issued the Hegemony Charter, which he claimed was a "fair but responsive government free of all the vices and faults of the previous administration."

Notably, ultimate authority law in a "single head of state chosen, but not ruled, by the people," the Director General. Like many dictators benevolent and otherwise, McKenna then came to power in a popular election. He was elected

the Hegemony's first Director General and Lord Protector in February 2316, and all evidence suggests the ballot was fair—even though it also informed voters that the man they were electing would remain in office "until his death or voluntary retirement." Which, I suppose, says how happy Terrans were to see the insanity of the Alliance end in such a quick and decisive manner.

**TERRAN HEGEMONY**

After such a dramatic erasure of the old order, McKenna's voters were less enthused about the resulting new government—because it quite resembled the old, at least on paper. McKenna

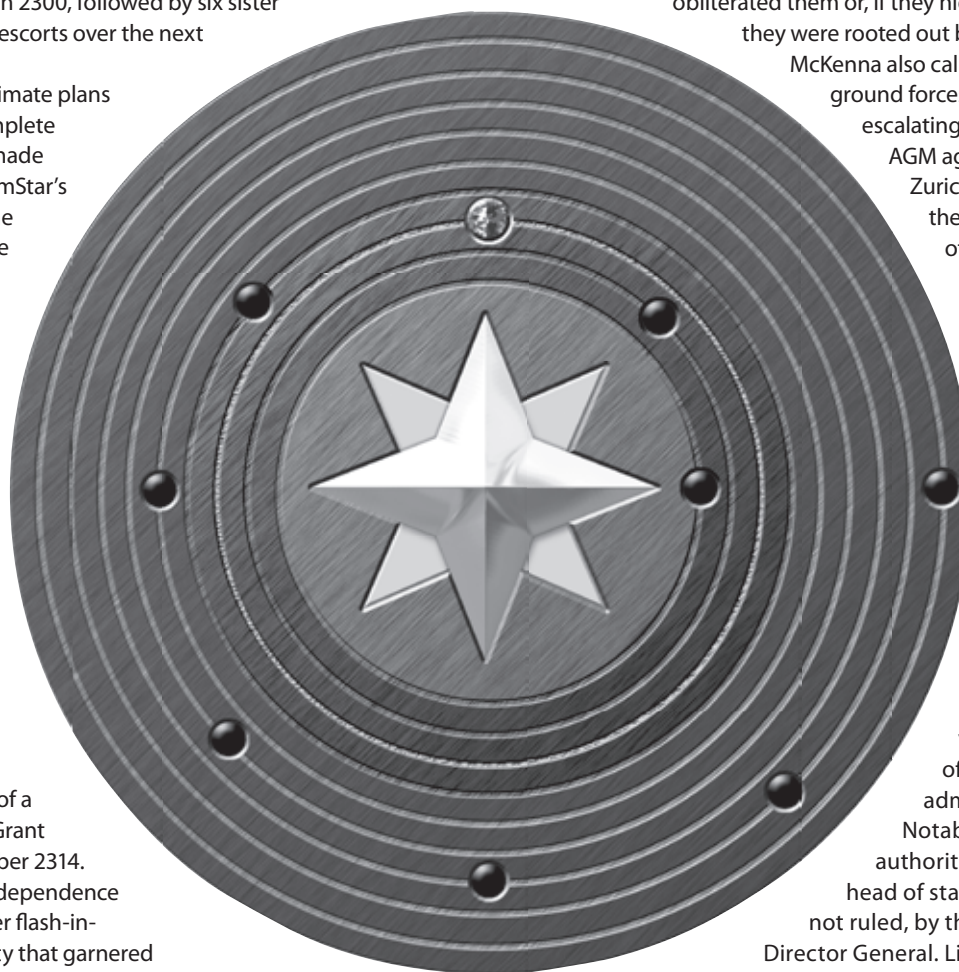

## TOURING TERRA



had studied history sufficiently to understand that completely eliminating an old government produced nothing but anarchy and collapse. (This is a point that Aleksandr Kerensky and the Hegemony should have minded in the 2780s.) He certainly executed many an Alliance Parliamentarian, but left the basic bureaucracy in place (it was pruned considerably in following years, but only once Terra was stable.) As before, national and continental leaders continued to rule as they wished (though there were a multitude of new regional governments on Terra after 2315 as irate citizens emulated McKenna's "house cleaning" locally.) Each planet in the Hegemony then received a Planetary Congress, which worlds could alter as they saw fit. Superficially, this quite resembled the old Alliance.

The difference, though, was a new executive branch that was a virtual nobility. Instead of being part of a Planetary Congress (as under the Alliance's Parliamentary system), this executive branch of the Hegemony stood apart rather like the defunct American system of government. Planetary Governors were elected to eighteen-year terms of office, while the Director-General was a lifetime risk (barring removal for high crimes). Planetary Congressmen started with a two-year probationary period, followed by eight-year full terms. These lengthy terms were based on McKenna's belief that the instability of the late Terran Alliance had resulted from politicians' constant fear for their political careers.

At the uppermost level, the Hegemony was run by the Director-General, who was advised by the High Council. The High Council was staffed by the nine "most qualified" Planetary Governors, and served effectively as the heads of bureaucratic departments. ("Most qualified" was not defined in the Charter. What was defined, though, is that a High Councilor served at the discretion of the Director-General, which meant the Director-General could select any Planetary Governor that suited him.) Below the High Councilors was the President of the Terran Congress, who also served as Director-General Pro Tem when the Director General was away from Terra. The Terran Congress served as the peak of the new nation's legislative branch, with other Planetary Congresses serving as a lower tier of government.

McKenna worked hand-in-hand with the first President of the Terran Congress, Sonya DuKirl, to eradicate the rampant corruption and cronyism in the Terran government. While slow, this would come to pay dividends of public goodwill to McKenna in his later years as Director-General. Cutting taxes and repealing onerous regulations (such as completely eradicating the "artistic administrators" and artist licensing) produced more immediate results.

By 2316, McKenna felt ready to act on his other plans for Terra and humanity. He made no effort to hide his goals for reuniting all of humanity. Most of the Terran Alliance's planets joined eagerly and sent representatives of the Hegemony Congress. A dozen more had to be politically pressured, and Altair and Caph required

military intervention. After securing the Hegemony's borders, he then turned to foreign planets and started using trade and diplomacy to entice them into the Hegemony. This worked for a few worlds, but most cared little for distant Terra. This resulted in two "campaigns of persuasion," which netted the Hegemony over forty worlds by the 2320s.

McKenna changed his tone in the 2320s as, after the two military campaigns against independent worlds, the Hegemony faced the fledgling interstellar nations that surrounded the Hegemony. The military campaigns had revealed numerous shortcomings in Terra's vaunted military technology, leaving McKenna uncertain of victory against even one of the larger proto-states. (The Hegemony had the lion's share of humanity's industrial and military might, but that meant little when forced through the bottleneck of interstellar transport.) He accordingly changed tactics to diplomacy, toned down his rhetoric (Terra would now be the repository of all of mankind's knowledge and compassion instead of the realm that united humanity), and established full diplomatic missions with many interstellar nations. And he began overhauling the Hegemony Armed Forces.

In 2335, McKenna returned to military force to seize enticing unaffiliated worlds. This third "campaign of persuasion" started well, with the improved HAF seizing a half-dozen worlds (including notorious Denebola). Public and military morale was high, and the 300 WarShips commanded by McKenna's son Konrad seemed like an unstoppable juggernaut. (As an aside, I'd emphasize that number of WarShips again and suggest readers compare it to the fleet James commanded in 2314. It says something about the damage wrought by the Succession Wars that in a similar twenty-year period starting in 3050 the entire Inner Sphere only produced a fraction as many WarShips as the Terran Hegemony.) Konrad, though, snatched defeat from the jaws of victory with increasingly risky tactics. The 2338 Syrma Ambush destroyed 67 ships, 33 troop transports and 34 WarShips, and led to James McKenna stripping his son of all rank and honors before himself retiring to avoid having to put his son on trial. James McKenna died ten days after retiring at the age of 64, falling prey to a malignant cancer.

James McKenna left a Terra with a new spring in its step, a thriving economy, and a powerful military. His successor would have a high standard to live up to, but did so. After a confirmation vote by the Terran Hegemony public, Michael Cameron would build on James McKenna's foundations to turn the Hegemony into one of the most successful empires in history and establish his dynasty as its leader.

**TERRA IN THE HEGEMONY**

The Hegemony was a nation of over one hundred star systems that, in the middle twenty-fourth century, represented about three quarters of the human population and a larger percentage of its economic might. It had the longest-settled worlds and, by virtue of their proximity to Terra, those worlds had received the most



## TOURING TERRA

colonists. James McKenna and Michael Cameron worked tirelessly to integrate them into an interstellar superpower, and succeeded.

However, James McKenna had taken a lesson from the Terran Alliance's history, and Michael also heeded it: just as there had to be an undeniable head of state for the Hegemony to succeed, there had to be an undeniable capital planet. A world that could back constitutions and treaties with sufficient force (economic, military, or otherwise) to ensure the laws on paper remained laws in fact. And so the Hegemony was the *Terran Hegemony*, with all Hegemony member-planets sending representatives to the *Terran Congress*. This wisdom was born out in McKenna's "campaigns of persuasion," when Terran arms and soldiers carried the day in battle after battle while units raised from other Hegemony worlds quailed or broke. At the dawn of the Hegemony, Terrans did not shy from "getting their hands dirty" in the process of empire building.

Within a mere half century, Terra turned from a world crippled by its own insane government to the beating economic, political, and military heart of the Hegemony. Stripping the crushing taxes and a labyrinth bureaucracy from Terra were perhaps the most effective measures, but the Directors-General of the Hegemony and High Council would never shy from directing government contracts to Terran companies even when other Hegemony worlds offered lower bids. This was particularly obvious with Terra's glut of arms manufacturers.

Terra was not entirely coddled, though. Michael Cameron continued McKenna's policy of weakening Terran nationalism, or at least redirecting it as patriotism to the Hegemony. He

had a huge head start thanks to the Terran Alliance's abuses, which—as I noted above—were often endorsed or conducted at the behest of national governments, leaving many Terrans feeling less than supportive of their homelands. Other regions,

like America and China, remained firmly attached to their old cultures (and even rationalized the 2315 insurrections against their governments as patriotic endeavors). These areas

were not actively anti-Hegemony, but some districts felt that the Hegemony was too obviously trying to eliminate their legal and cultural identities.

This was true, but not something a Director-General could admit in public. Instead, Directors-General often used subtle reductions in legal power accompanied by, basically, bribes. For example, when the Hegemony started finding itself hemmed in by other interstellar

nations in the 2340s, it turned to terraforming the marginal worlds within its borders and encouraged settlement by cultural groups. The recently rediscovered world of New Dallas is one such example. Choice contracts often went to companies based in those Terran regions, too, and their militias were equipped with some of the finest equipment. On the other hand, many of the terraformed worlds required extensive technological support to maintain their new environments, which made them dependent on the Hegemony government.

Overall, these efforts worked. To jump ahead in my narrative, following the Liberation and the collapse of the Terran Hegemony central government, worlds like New Dallas remained rabidly

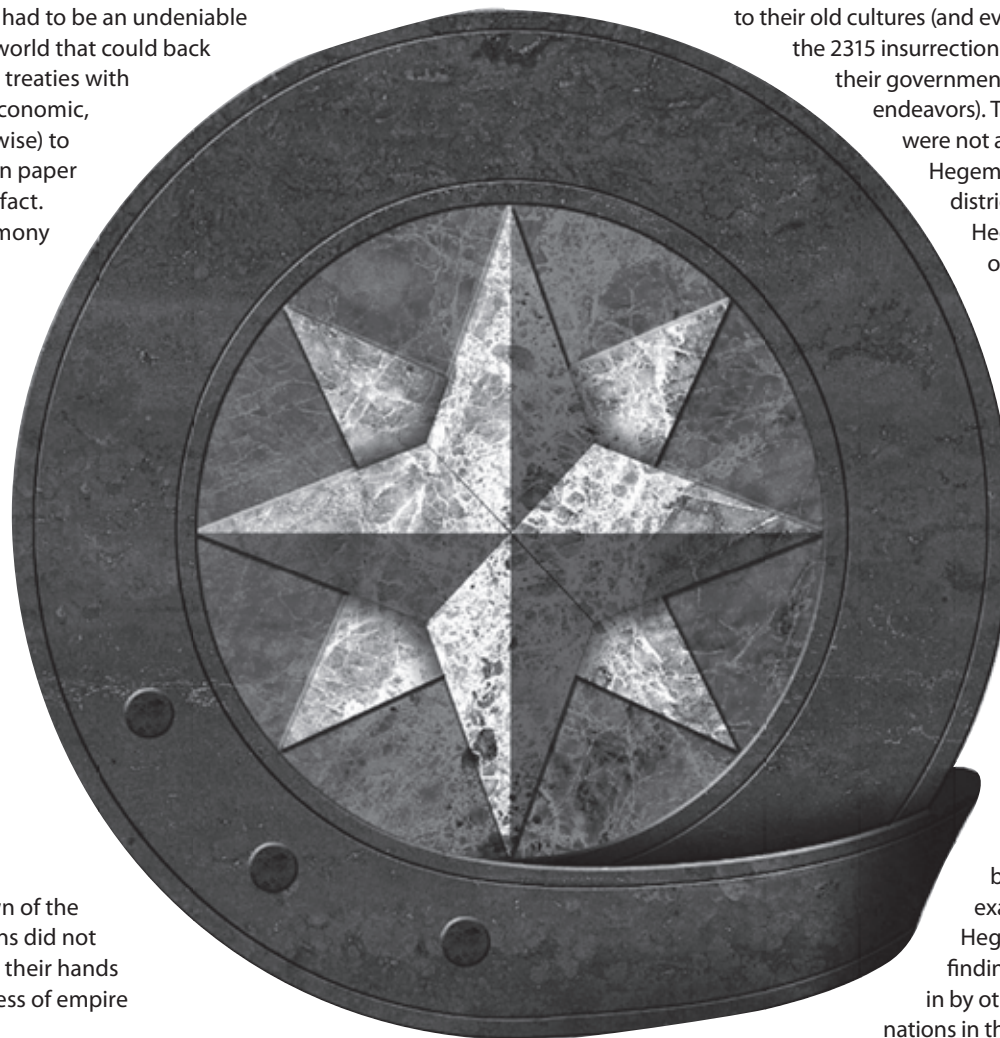

## TERRAN HISTORY



loyal to the ideal of the Hegemony and sought to cobble together a united defense against the encroaching Houses. They lured many of the remaining SLDF units (especially Royal units) to their banners and dealt such stinging setbacks to the Houses in the First Succession War that they drew some of the heaviest nuclear attacks seen outside the Bolan Thumb. And it is for this reason that Alliance- and Hegemony-dominating cultures like America, India, and Brazil are so poorly represented in the modern Inner Sphere. They got the best worlds close to Terra, or *made* the best worlds close to Terra, and were lost with them in the First Succession War.

Though the Hegemony was being hemmed in and its neighbors were matching its military might, it did not cease growing after the "Campaigns of Persuasion." Its growth transformed into the areas of technology and business. The early Hegemony held individuals who were, proportionally, the wealthiest to ever live. The few dozen or so owners of early interstellar conglomerates and private colonies held a noticeable percentage of humanity's net worth. In later eras, there would be wealthier individuals on an absolute scale, but they lived in an era when the population was significantly larger and richer, too. The wealth was not restricted to these individuals; most of the Hegemony's worlds saw climbing income as the Hegemony's stimulus efforts triggered local growth and their employers reached out to foreign markets. Terra, of course, was the hub of all this and with its natural advantages (e.g., the oldest, largest financial institutions in human space), it grew the most.

By the middle of the twenty-fourth century, the Terran system was transforming thanks to this growth. Gone was the grim paranoia of the late Terran Alliance. In its place were exuberant displays of wealth. Venus's incredibly rich deposits of fertilizer, byproducts of sequestering the excess nitrogen in its atmosphere, made it extremely easy to transform the world into lush garden

adored by tourists, wealthy Terrans desiring vacation homes, and farmers. (The excessively large, tropical seas that made it possible for Venus to be so lush would be the planet's downfall after the Amaris Coup.) Mars remained dry and dusty in most areas and thus drew few colonists, but Mars did lure the wealthiest individuals in the Hegemony in a land rush to the Grand Canal. This 1800-kilometer excavation effort between the Hellas Basin Sea and Isidis Planitia Sea required carving a canyon kilometers deep, moving bedrock on a scale never again duplicated. The Grand Canal was not simply gouged out of Martian bedrock; it was sculpted. Private fjords, garden terraces measured in square kilometers, and statues and bas reliefs kilometers tall were carved on its flanks. Terra itself was beautified. The ecological reconstruction efforts of the Terran Alliance to repair centuries of primitive industrialization damage to Terra were completed, including contentious (for their despised genetic engineering) resurrections of many extinct species. The Hegemony could even afford (over a period of decades) to steadily buy up exurban and suburban land from its billions of owners and convert it back to natural land, leaving Terra a world of densely inhabited cities and scattered small towns. In those cities, the displays of wealth continued. Skyscrapers of incredible height and exotic designs were built (some of the more aesthetically successful ones remain; the more garish ones were generally demolished in less ostentatious eras). Terra's elite built rural homes of incredible opulence, though their excesses on Mars and private continents on other planets surpassed their homebuilding on Terra. Monuments and urban beautification also turned Terra into a jewel amongst mankind's worlds.

In order to maintain its edge, the Hegemony focused heavily on education and research. Michael Cameron founded the Hegemony Research Alliance Department (HRAD) to undo the damage the late Alliance had wrought on its research





## TOURING TERRA

establishment. HRAD delivered quick results like a briefcase-sized fusion generator, cures for many alien diseases, and much more powerful myomers, along with notable failures like paper prophylactics. The Hegemony's educational system, including the ancient universities of Terra, was a beacon of knowledge for the rest of human space.

Under Michael Cameron, the Hegemony's government began to transform. A scholarly and intellectual man, Michael sought the same qualities in the civil service. The latest theories of management were trialed and then implemented in law, and merit-based testing was used for advancement ensured most Hegemony officials were intelligent and capable. (Generous salaries also helped lure them out of the private sector.) By the end of the twenty-fourth century, the Hegemony's government was—as far as governments go—a model of efficiency and capability.

Society was changing, too. Where James McKenna had created a virtual nobility of elected officials with long terms, Michael Cameron introduced real nobility. Although Michael intended his titles of nobility to be non-inheritable awards for exceptional performance and to encourage better performance, the ban on inheritability did not last long. Indeed, shortly after issuing the first patents of nobility, he issued Cameron's Edict of 2351. This enabled his daughters to retain their names through marriage, and virtually guaranteed that one of his offspring would be his successor. The Succession Bill of 2392, introduced by Director-General Brian Cameron, made it almost impossible for a non-Cameron to be Director-General (though public confirmation votes were still required). In 2432, Richard Cameron revised the Nomination Laws to allow a Director-General to essentially select his successor without anyone's input.

The Age of War barely reached the Terran Hegemony, let alone Terra—except to enrich Terra's arms manufacturers. The Capellan Confederation, Draconis Combine, and Free Worlds League frequently raided the fringes of the Hegemony to little effect until the 2409 Capellan invasion of Terra Firma, which was still handily defeated. Even after the signing of the Ares Conventions, which introduced a nearly-bloodless form of warfare at which the HAF excelled, the Hegemony largely remained quiescent but for minor border skirmishes—and continuous improvement of its military, resulting in the introduction of the BattleMech and subsequent innovation in its design.

Instead of intensive warfare, the Hegemony took up a role of mediator. Director-General Deborah Cameron made this into a formal policy, which she called her "Strategy of Aggressive Peacemaking," where the Hegemony actively sought to end conflicts between other nations before the Hegemony became embroiled. By 2540, Lady Deborah rightfully considered her policy to have succeeded. In addition to the high-minded benefits of ending wars, each diplomatic success that quieted wars between Terra's neighbors likewise

reduced the chances of the Hegemony being drawn into those conflicts. Such negotiating also gave Terra noticeable influence over the other Houses.

Thanks to Deborah Cameron and her successors, Joseph and Ian Cameron, this trend in peacemaking and mediation reached its ultimate extent with the formation of the Star League on 9 July 2571, when the leaders of the six Inner Sphere Houses signed the 2,000-page Star League Accords. Among many other points, the Accords recognized that only Cameron heirs would be the legitimate First Lord of the Star League, which also vaulted Terra to the center of a new empire.

To accommodate this role, Terra received the Court of the Star League, unofficially known as Unity City, in the North American region of Puget Sound. Though since marred by eruptions from local volcanoes and, of course, Stefan Amaris, Unity City was and is an architectural marvel. It was constructed from the most beautiful materials around the Inner Sphere, and also was held to a consistent, clean vision by chief architect Hannah Crawford that spared it from become a gaudy and overwrought extravagance. A visiting architect noted Unity City was "a fairy-tale place, where parking garages are as beautiful as the Taj Mahal."

The selection of Unity City's site was the basis of one of the Star League's first corruption scandals, too, as the Count of Seattle and CEO of Boeing Interstellar Charles Chaffins unashamedly lobbied for the anticipated Court of the Star League to be placed in his domain. With extremely deep pockets (rivaling that of many twenty-sixth century Inner Sphere planetary economies), Count Chaffins mounted a successful campaign of legal lobbying, advertising, and smearing of rival locations along with less legal bribery, blackmail, vote buying, and intimidation that reached up to the Hegemony's High Council. Claims of violence and assassination were probably exaggerated, though a number of advocates of other sites did disappear. He had the whole-hearted support of the North American district government, which offered numerous tax breaks and financial aid to the project. Hosting Unity City would be a cap in the feather of the continent that had produced James McKenna and some of the most influential Hegemony nobles. Director-General Ian Cameron seems to have supported the site selection based on his favoritism of the American football team, the "Seattle Seahawks," which, incidentally, outlived the Terran Alliance, USA, Terran Hegemony, and Star League to play the sport to this day.

(While serving 3 months of house arrest for misdemeanor violations of election laws, the only charges substantiated against him, Count Chaffins penned, *"On Politics,"* a short and eloquent treatise on management, leadership, and execution of power that is as cold blooded and cutthroat as the ancient work *"The Prince,"* by Machiavelli, and is filled with examples and suggestions that remain applicable to today's corporate and political leaders. It remains a popular work for modern political science students and is required reading for many Kuritan nobles.)

## TOURING TERRA

**TERRA IN THE AMARIS COUP**

In two additional centuries reprising its Hegemony-era role as the heart and homeworld of mankind for the Star League, Terra only grew richer and more populous as people flocked to it rather than emigrated. Technology was refined to yet greater heights. The average lifespan in the Inner Sphere, from golden Terra to plague-blighted, backward Annapolis was 120 years—on the most advanced worlds such as Terra, it was not unknown for women to start their family near the beginning of their second century, when they still several decades of health and vigor left to them. Art was extravagantly supported, producing some of the greatest works in all fields of artistic endeavor in all of history (and, of course, plenty of gaudy horrors.) There were economic troubles to be sure, and the Houses were squabbling a bit, but every civilization had its rough spots.

Then Terra fell afoul of Stefan Amaris. Most school children are aware of Amaris's character. He tricked poor little Richard Cameron into friendship, used nuclear weapons on mankind's homeworld, brought down the Star League, ordered the executions of many people (personally killing Richard), and probably even talked in theaters during holoivid showings. More nuanced versions of history will grant he was also quite intelligent and an able schemer who could probably add a few chapters to Chaffins' *"On Politics,"* while Periphery nations note that he was not simply out to destroy the Star League (as the shorter summaries suggest) but to rule it.

In all the retellings of the horrible things Amaris did to Terra and the Hegemony during the Star League Civil War, though, two issues are rarely addressed. First, Amaris did not start out as a brutal dictator of the Hegemony. Though Amaris or his toadies committed crimes against humanity throughout his reign, the worst atrocities committed in Amaris's name happened in the last few years of the Star League Civil War. Second, in all the rushing to denounce Amaris, few ever answer the question: what did Terrans and the Hegemony think of Amaris?

Before you answer that using words like "hated," "feared," "despised," and so on, think a moment: Stefan Amaris declared himself First Lord (well, Emperor) of the Star League and Director-General of the Hegemony in January of 2767. He accomplished this by personally executing Richard Cameron and "sneaking" the Rim Worlds Republic military into the Terran Hegemony. But by 2769, the Republic had become the *SLDF's* staging base. Republican taxes and factories supported Kerensky's crusade against Amaris. This left Amaris without support from his home base for ten years, including almost seven years of total war (2772-2779) against the largest military in human space. Even with all the Hegemony's fortifications and SDS network, simply relying on his original Rim Worlds troops and mercenaries to fight the giant *SLDF* was not feasible, not over seven years of warfare that would eventually kill 100 million Hegemony citizens and render homeless ten times that number. And many of Amaris's most loyal units had family and land in the *SLDF*-subjugated

Republic—they were not going to stand and defend a foreign land for most of a decade against a foe that had a gun to the heads of their families. So, again the question: what did Terrans and the Terran Hegemony think of Amaris?

Well, a great many of the highest Hegemony nobles and civil servants were rather in favor of him; quite a few eagerly supported him. About a third of the population liked him; another third tolerated him. The remainder voted against him in the Director-General confirmation vote, but few were so opposed to Amaris that they raised arms against him.

Why? How is it possible that Amaris the Cameron toady, Amaris the Periphery liberator, Amaris the Periphery betrayer, Amaris the Usurper, Amaris the sycophant, Amaris the drunken fop, Amaris the butcher, could be voted into power in the Hegemony and earn the Hegemony's collaboration for twelve years, including seven years of dogged civil war against the *SLDF*?

Stefan Amaris presented different, carefully crafted appearances to different people, as noted in a multitude of prior works. They were generally self-deprecatory appearances that led to him being underestimated, and he generally only revealed otherwise to a select few—the leaders of the Periphery, for example, when he began providing them BattleMechs. He presented another one to the leaders of the Terran Hegemony: a mediator between the Hegemony's leaders and a distant, incompetent Richard Cameron. To them, Amaris was intelligent and sensible, a man who pretended to be a fool to befriend the real fool—Richard Cameron, who was endangering the Star League and the Hegemony's public by enraging the Houses (such as with Executive Order 156, disarming the Houses) and inciting the Periphery (via the Taxation Edict and the kind). Likewise, the Hegemony public had a favorable impression of Amaris for many reasons. The Rim Worlds Republic had been the friend of the Hegemony for two centuries. During the Star League, huge numbers of Hegemony citizens—inhabiting a realm hemmed in on all sides by other nations—terraformed and settled new worlds notionally administered by the Rim Worlds, feeding that realm's enormous expansion between 2571 and 2750. They were comfortable with the Republic because, it seemed, those worlds were nothing but an extension of the Hegemony, whatever the flag that flew over the planetary capital. Amaris himself held a dual citizenship between the Republic and Hegemony. And they largely accepted Amaris's praise and claims of friendship between the realms. (One might note that Adolph Hitler was not German, but from neighboring Austria.) On the other hand, the people of the Hegemony were—like their leaders—quickly becoming disillusioned with the incompetency of Richard Cameron.

The initial violence of Amaris's coup was largely viewed in the Hegemony as an unfortunate necessity to eliminate the forces that would defend Richard Cameron. The Hegemony public received the change in government relatively passively, thanks to the collaborating nobles and Planetary Congresses. The Rim Worlds



## TOURING TERRA

troops handled the worst armed resistance, which did sometimes reach the level of entire planetary militias. Amaris had to claim his ridiculous title of “Emperor” because, due to the Star League Accords, only a Cameron could be First Lord but this too was tolerated by the Hegemony public. (Not that Amaris expressed too much reluctance at being deemed Emperor of the Star League. The man had an ego bigger than a battleship.)

And the Hegemony more than tolerated Amaris, it supported his war effort. Vigorously. Initially, many in the Hegemony were appalled that Kerensky would oppose the change in government, especially after Amaris’s public and relatively fair confirmation vote. Their national hero, James McKenna, had stepped in through just such a change in power when the old government proved incompetent. It wasn’t until the last years of the Liberation that the Pretender’s brutality cost him the earnest support of the population and leadership; thereafter, his support was from collaborators terrified of what would happen to them for backing Amaris. And so much of the fight against Kerensky was waged by the Hegemony’s people and its giant armaments industry—the Star League Civil War was very much a Civil War.

Today, many people boggle that the House Lords of the late Star League did not immediately side with Kerensky against the Usurper. In fact, some people at the time—the ones who are most often quoted in history books—also boggled about the lack of aid to Kerensky. However, the matter was much more complicated in the twenty-eighth century, when the House Lords had to accept that Amaris had been confirmed as Director-General (well, Emperor) of the Hegemony by a relatively fair vote. He had widespread backing by Hegemony nobles (who were intermarried with the noble families of the Houses) and entreated them

frequently accept Amaris as First Lord, or at least as “Emperor.” Quite often, clandestine aid to Kerensky that was portrayed in a righteous light by ComStar’s historical publications was nothing of the sort—it was House Lords playing Kerensky against Amaris and biding their time until better options were available.

At the end of the Star League Civil War, Amaris was ruling by force. He was resorting to brutal mercenaries—and the personal guards of Hegemony nobles—to hold onto his crumbling empire. He did order atrocities—not all can be blamed on overzealous underlings. He did fight scorched earth battles that crippled the wealthy worlds of the Hegemony. His actions did precipitate the collapse of the Star League and the incredible violence of the early Succession Wars. He earned the hatred heaped on him. Amaris was so reviled that anyone associated with him sought to minimize that connection or the idea they had helped him.

Terrans are a case in point. After liberation, they promptly installed an anti-Amaris government and loudly denounced everything done under Amaris’s rule. This reached the point that any civil servant who had been employed by the Hegemony during Amaris’s rule was barred from office, with disastrous consequences to the Hegemony’s reconstruction and recovery. (As I said earlier, the Hegemony should have heeded the lessons of James McKenna in retaining the existing governmental structure following a coup.) About the only thing the Hegemony government could accomplish coherently was to hunt down collaborators and put them on trial, though they had to compete for collaborators with vigilantes and Hegemony planetary governments. This was an oft-overlooked part of the reasoning behind Kerensky’s departure: despite at least five years since Liberation (up to twelve years for some Hegemony worlds), the

## TERRAN HISTORY



## TERRAN HISTORY

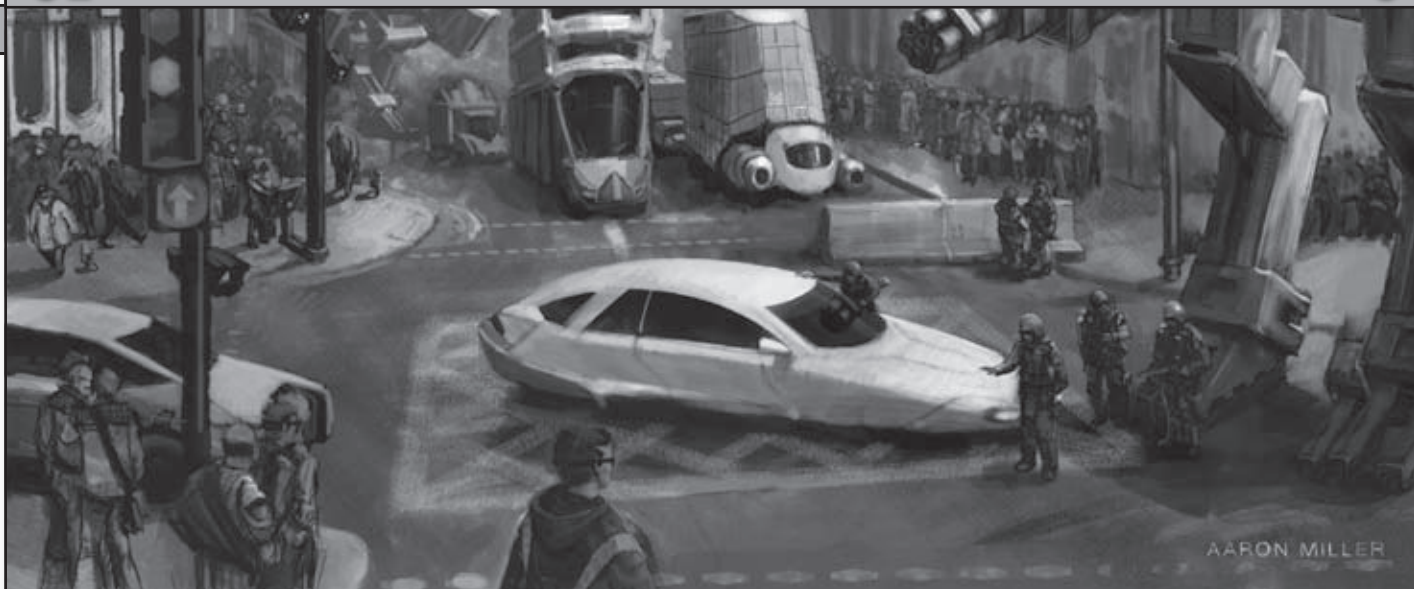

Hegemony was a “basket case.” Some individual worlds were doing quite well, but the Hegemony as a whole was not fit to rule be the *metropole* of the Star League and, without it, the SLDF was not in a position to prevent war from breaking out between the Houses. Indeed, the Terran Hegemony probably was not in any shape to support the SLDF in another major war, but the very attempt to have the SLDF intervene between the Houses would worsen the war.

Many people in the Inner Sphere respected Kerensky's decision to take the SLDF from the Inner Sphere. This was not so in the worlds of the Hegemony, where the people rabidly despised Aleksandr for abandoning them to the Houses and the worst war mankind has ever seen, the First Succession War.

### TERRA UNDER COMSTAR

ComStar's Operation Silver Shield had the avowed goal of protecting the homeworld of humanity from becoming a prize trinket for the approaching House Lords. In reality, the planet proved extremely useful in ComStar's early years when it supplied the funding, HPGs, and personnel to rebuild the HPG network. (It would not be until 2802 that ComStar would turn a true profit without injections of Terran taxes.)

Terrans were willing to support ComStar because of its aid in their time of need. Terrans had not seen the worst of the Star League Civil War, but Terra had seen its share of battles and North America, an industrial and political heart of the Hegemony, had suffered the most. Millions had been killed and the metropolitan area of the Pacific Northwest was smashed during efforts to secure Unity City. The world was virtually ignored by the House Lords after liberation, while the Hegemony government was paralyzed by inept, novice bureaucrats and politicians. In an infamous example, the metropolis of Chicago suffered famine in 2781 despite being literally surrounded by farmlands and serving as a

hub of transport for grain, beef, and dairy products because Hegemony Department of Reconstruction personnel in Geneva were redirecting all that food to the world of Keid based on the reports that Keid was starving. They were unaware of the suffering they were causing in Chicago or that Keid was a food-rich agricultural world due to ignorance and broken lines of communication within the government. The rebuilding Hegemony, in turn, lacked a sufficiently experienced internal affairs department to realize that a Keid noble was forging reports of famine to get “free” food from Terra to undersell business competitors on Keid so he could quickly rebuild his Civil War-damaged grocery chain. Among all these failures, it was only Jerome Blake's Star League Department of Communications that truly helped feed and house Terrans. By 2784, Blake had ended five years of refugee camps, famine, and homelessness amongst Terrans.

This was an auspicious start that ComStar nearly threw away within a century. Perhaps missing the lessons of Machiavelli and Chaffins, ComStar allowed Terra almost free reign and free thought under the Branch of Terran Affairs. Terra had essentially repaired all Civil War physical damage by the dawn of the twenty-ninth century, but was suffering catastrophic economic damage from a multitude of causes: the Terran Hegemony interstellar economy, of which Terra was its hub, was gone; half of Terra's twelve billion inhabitants had fled the planet by 2800 (“out of the frying pan and into the fire,” as it were), leaving the local economy unhinged; and the Inner Sphere was rapidly destroying any scrap of interstellar commerce in unrestricted warfare. This produced huge numbers of unemployed, disaffected people who easily forgot ComStar's past kindness and obsessed on Terra's lost glories. Fed, ironically, by ComStar's endless march of propaganda about how Terra was preserved from the First Succession War, Terrans became convinced that it would soon be time for them to reclaim their empire from the idiot House Lords. The problem, though, was that



## TOURING TERRA

they were not united by the Hegemony, but rather by a politically neutral and meek successor to the Star League Department of Communications. Political parties and radical groups arose in the mid-2800s that proposed to reverse this relationship (turning ComStar into a mere tool of a new Terran empire). ComStar reacted poorly, using ROM to round up troublemakers and send them to re-education camps.

This prompted a violent reaction from Terran radicals, who began bombing the re-education camps and other manifestations of ComStar. Under the new leadership of Primus Marteen, ComStar attempted to placate Terrans with a "Terra First" policy with construction of massive arcologies on Terra (as huge housing and employment opportunities), reconstruction of the Venusian sunshade to preserve that world's terraforming (abandoned after some engineering studies), and new industrial developments on Mars. The Terran response to this was lukewarm and it appears that Marteen was extremely worried about losing Terra based on multitudes of public opinion polls, which indicated many Terrans thought she was merely mouthing platitudes. The situation was swiftly ended, though, in 2877 when one group of radicals (Black December) bombed the Euro-English Channel Tunnel and killed over 1,000 civilians in an attempt to kill Precentor New Earth, then publicly claimed responsibility. Terrans were appropriately outraged at all bomb-tossing radicals, ROM saved the day by eliminating Black December, and ComStar reaped a bountiful harvest of gratitude from Terrans.

Human space would be a very different place today if Terrans had discovered then that Marteen was behind the bombing, instead of waiting for Focht's revelations in 3055.

After this brush with independence, Terrans settled into the protected nook behind ComStar's robes for the following 175 years. They turned inward to celebrate their regional cultures and languages, inspired by dozens of inspirational leaders (who were largely ComStar agents aimed at keeping the sleeping beast of Terra from awakening again.)

### THE WORD'S TERRA

Anastasius Focht, who is likely Frederick Steiner, introduced sweeping changes to ComStar in 3052 that included unlocking the Hall of History. This rocked the Inner Sphere, but the counter-arguments of the new Word of Blake (Summary: "Lies! All lies!") defused some of the impact. Terrans, on the other hand, were in possession of vast sums of data in their millennia-old computer network that could corroborate Focht's claims that ComStar had been interfering with Terran lives for centuries. As a sophisticated,

computer-literate people, Terrans were in turn discouraged from massive rebellion against ComStar because, basically, they were ready to question any such knowledge that suddenly turned up on computer networks as a forgery. The damage, though, was done. Had ComStar continued in its original incarnation, it seems likely that Terra would have cast off ComStar.

But before that could happen, the Word of Blake—old ComStar's spiritual inheritor—reclaimed the Terran system. Two decades ago, it was hoped that Terrans would unseat their new masters and embrace freedom. Unfortunately, the Word of Blake offered Terrans something better than freedom: an empire. The old Hegemony reborn.

While the Word of Blake did impose some limitations on the Inner Sphere's access to Terra (and vice versa), it seems now that Blakists unleashed the beast that Primus Marteen sought to muzzle. The Word of Blake Protectorate has the official stamp of Blakism, but many of its early members were attracted by trade and diplomatic envoys from Terra espousing a new Terran Hegemony. Readers might wonder at the attraction of Terra for worlds long since "liberated" from Terra's yoke, but do remember how the Houses treated the worlds of the Terran Hegemony: they were prizes to be seized quickly and any disputes by other claimants were settled with vicious use of weapons of mass destruction. Many of the worlds depopulated in the First and Second Succession Wars were Hegemony worlds. After their conquest by a House, they were then favored targets for raids in the Second and Third Succession Wars as their mighty Star League-era industries were targeted for conquest or destruction. In the Hegemony, on the other hand, they helped dominate the Inner Sphere and Periphery. No one should be surprised that Terran envoys were and are able to keep the Protectorate together despite exaggerated reports of the Protectorate's instability. The Protectorate gave them jobs and revived their military might.

What gives me hope for the coming conflicts against the Protectorate is that it seems the Word of Blake has only built an alliance of convenience. Many captured Terrans in Blakist Militia ranks have not spoken warmly of the Word; they sought to build something out of the abandoned worlds of the Chaos March and perhaps rebuild the Star League, not spread Blake's word. Worlds of the Chaos March are somewhat more worrisome, as their militia has spoken of centuries of accumulated anger toward the Houses that conquered, raided, and bombed them. One hopes that Devlin Stone can find a way to separate the loyalties of the Protectorate from the Word.

—Bertram Habeas, 12 December 3077



## TOURING TERRA

**TERRA: A PEOPLE**

—Excerpted from Pierre Kagame's *The People of Terra*, Stellar Geographic Publications, 3077

Like many worlds of the Inner Sphere and major Periphery states, Terra is populous, advanced, industrialized, and wealthy. However, it stands out in many ways—the unparalleled diversity of its people; the depth of its history; its level of wealth and technology; and much more.

**A WORLD OF DIVERSITY**

The individual worlds of the Inner Sphere have a common feature: homogeneity. Most planets were only settled by a handful of groups of colonists, and drew from their ethnic homelands on Terra to expand. The “ethnic” stamps of the Great Houses are often misleading in this regard, being the home culture of the House Lords’ families pressed on many different peoples. The Combine world of Annapolis, for example, is one of the most authentically “Kuritan” worlds of the Combine, exhibiting many attributes of an idealized Edo period of Terra’s Japan, despite being settled primarily by North Americans (themselves primarily descendants of many European nationalities). Many worlds have since developed some regional cultures, often dating from early colonial periods when primitive settlements were isolated from each other. The huge cultural difference between Solaris VII’s rural and urban areas is a prime example. Still, anthropologists and ethnographers usually have little trouble tracing a planetary culture’s roots back to Terra. So, just how complicated was Terra’s society to produce so many different cultures?

At the dawn of the Terran Alliance in 2015, depending on one’s definition of languages versus dialects, there were approximately 7,000 living languages in use. (Though then, as now, English was a *lingua franca*, and only about 100 languages accounted for about 99 percent of daily conversations.) The number of cultures or ethnicities is harder to pin down, but to pick some regional examples, the People’s Republic of China recognized 56 different ethnic groups within its borders in 2015, and its southern neighbor India recognized 645 distinct tribes (and had 29 languages spoken by more than a million people, with 1,652 languages recognized overall.) These select examples only accounted for a third of Terra’s population; Africa and Europe were also finely divided into many different ethnic groups. The North and South American continents and the island continent of Australia were once equally complicated mixes of cultures as the other Terran lands, but European settlement in the latter half of the Second Millennium exterminated the native cultures almost as thoroughly as the natives themselves. The settlers who replaced them did come from many lands and formed new ethnic groups of their own.

The number of living languages and cultures on Terra dwindled and blended together in the Third Millennium

under the relentless pressure of modern telecommunications and dominance by a handful of cultures (the defunct USA, for example, managed to force the early Terran Alliance to accept English as the official language of the Alliance.) Throughout the Terran Hegemony and Star League, protection of Terran cultures and languages was modest at best, a result of the recognition of Terra as the cradle of humanity and thus all its facets were worth preserving (if only in museums).

This trend was finally arrested in the twenty-ninth century when ComStar found itself ruling a planet that had been shattered by the Star League Civil War, the loss of its empire, and was awakening to the recognition that it was actually better off than the Inner Sphere around it. Terrans had spent several decades of maudlin introspection until this point; ComStar latched onto that as a way to keep Terrans from breaking free of its control. ComStar adroitly encouraged Terrans to continue this peaceful contemplation of their history and cultures (after framing the Terran independence movement for bloody massacres, which cost the independence groups their popular support.) Terrans took to this promotion of homeworld culture as a means of lifting themselves from their destitute state, rather than a recidivist reconstruction of the Terran Hegemony. (The Word of Blake, it should be noted, appears willing to play with that particular fire.) Culturally, the impact has been enormous: today, over a hundred languages are in everyday use on Terra, more than all the languages of the Inner Sphere (discounting dialects).

Visitors will find the various districts of Terra exhibiting radically different cultures united only by Star League Standard English, which is often a second language to Terrans. Historians and anthropologists might objectively note these cultures show distinct differences from the historical cultures they supposedly replicate; the ebullient and hardworking Americans of modern Terra, for example, show markedly less jingoism and social conservatism than the twentieth and twenty-second century Americans they idolize. (One Terran ethnographer recently noted, “Americans have turned into Canadians,” which probably means more to Terrans than the rest of the Inner Sphere.) Racism, sexism, and other regrettable culture aspects of ancient Terran nations are markedly absent even in cultures that were once defined by them, like the severely segregationist South Africa of the twentieth century.

Those cultures and districts fall roughly along the lines of the Terran Hegemony’s districts, in turn based mostly along the lines of Terran Alliance member-states. The names of the districts are often familiar to students of history (France, Germany, Spain, Argentina, South Africa, Australia, etc.), though some former Terran Alliance member-states are now divided around prior internal borders (e.g., the United Kingdom is no longer united or a kingdom, but the region now consists of the provinces of Ireland, Scotland, Wales, and England), and some districts are simply new (the vast lands of China, Russia and North America



## THE WORLDS OF MARS

## TERRA

**TERRAN SYSTEM GENERAL FEATURES****Star Type (Recharge Time):** G2V (183 hours)**Number of Planets:** 9**Recharging Station:** Both**HPG Class:** A (Multiple)

The Terran star system consists of nine planets, hundreds of moons, and several asteroid belts and clusters. The planet closest to the primary, Sol, is the small rocky world Mercury. Next out is Venus, another rocky world undergoing the last death throes of a failed terraformed environment. Terra is the third world, followed by terraformed Mars. In between Mars and the gas giant Jupiter is a typical asteroid belt. The remaining planets are mostly gas giants. In order, they are Saturn (host of the moon Titan), Uranus, and Neptune; Uranus and Neptune might be more properly called ice giants than gas giants. Beyond and about Neptune is another asteroid belt of icy wordlets, the Kuiper Belt, of which the ninth planet Pluto is a member, and far beyond the Kuiper Belt is the prototypical Oort Cloud.

This system probably has most space traffic of any in human space. Millions of Terrans make the short flight to Luna annually for the resorts there. Mercury and Mars ship relatively huge quantities of raw materials to Terra to replace Terra's small recycling losses. Countless small craft and DropShip flit amongst the habitats of the Belt. A steady stream of craft arc outward to Saturn and the Kuiper Belt, while a JumpShip service visits the habitats in the Oort Cloud. Virtually every Terran city with a population of greater than a million has a modern, efficient spaceport (Terrans see no reason to bottleneck space transport through a few key ports and then distribute goods and passengers by conventional ground, air, and sea transport for possibly thousands of kilometers, instead landing vessels much closer to their customers or passengers.)

**TERRA****Noble Ruler:** President of the Terran Congress Chris Windsor-Cameron**Position in System:** 3**Time to Jump Point:** 9.12 days**Number of Satellites:** 1 (Luna)**Surface Gravity:** 1.0**Atm. Pressure:** Standard (Breathable)**Equatorial Temperature:** 22°C (Arid)**Surface Water:** 71 Percent**Highest Native Life:** Mammal**Population:** 6,350,000,000**Socio-Industrial Levels:** A (Advanced)-A-A-A-A**Affiliation:** Word of Blake

Despite a long administration by the ComStar of old and its ideological successor, the Word of Blake, Terra is not a grim world of robed Blake-worshipping minions and continents

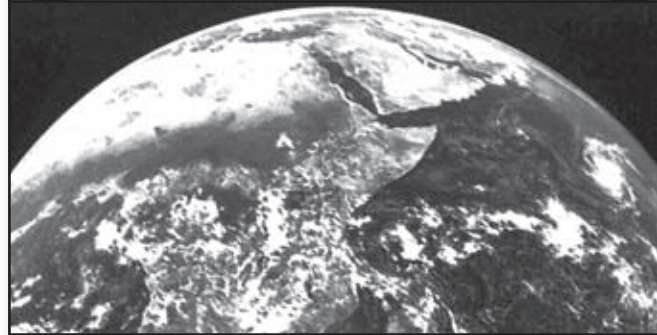

covered in military factories. ComStar and the Word of Blake used the intermediary of the secular "Branch of Terran Affairs" to govern Terra. BoTA is a professional civil service, a descendent of the Hegemony government, which runs Terra with a relatively light hand, though it was not a democracy. Under BoTA's administration, Terra rebuilt itself from the damage of the Star League Civil War and eventually thrived in isolation from the Succession Wars.

The long efforts of the Terran Alliance, Hegemony, Star League, and BoTA have undone centuries of aggressive industrialization and growth that occurred near the beginning of the Third Millennium. Pollution clean-up, ecosystem repair, and reduction of urban sprawl have reduced mankind's impact on the homeworld until more of it is in a pristine state than at any time in the past 1,500 years. The populous metropoli of Terra are compact and built up, surrounded by restored fields and forests. Factories are usually unobtrusive, underground facilities.

Those unobtrusive factories are enormously productive, though, giving Terrans the highest standard of living in the human space. Typical of most modern Inner Sphere planets, they range from small, flexible job shops to giant, specialized assembly lines churning out some common good, and are scattered widely across the planet. The military factories are generally located far from population centers, though component suppliers may be embedded in the center of metropoli. The factories and cities are webbed together by transportation networks of trains, ships, trucks, aircraft, and DropShips that would make any House capital proud. Despite a famously large amount of interplanetary travel, Terra is typical in that far more goods are shipped by conventional on-planet transport than spacecraft. And both due to necessity (as Terra is quite mined out) and respect for its environment, Terra uses its advanced technology to recycle virtually everything in great fusion-powered plasma elemental separators, requiring only modest amounts of ore from Mars to make up shortfalls.

While Terra is the standard by which all human-settled planets are measured, and it is far more lush and habitable than most human-settled planets, Terra is not a pole-to-pole garden.

## THE WORLDS OF MANKIND'S HOME

Much of its land area is naturally arid and even forbidding to humans. Visitors rarely see that aspect, as most cities are, understandably, in the more pleasant regions.

The planet has seven continents: Africa (almost certainly the home of the human species); North America, South America in the western hemisphere; frozen Antarctica at the South Pole; island Australia straddling the Pacific and Indian Oceans, and then the long northern hemisphere stretch of Europe and Asia. Other than Antarctica, all the continents are well-populated.

They are not as well populated as in 2750, though. Immediately following Liberation from Amaris, half of Terra's twelve billion people fled to the rest of the Hegemony and beyond. In the following three hundred years, Terra has maintained a relatively stable population that has only started climbing slightly in this century.

Once the center of empires, empires with enemies, Terra was and is one of the most heavily defended planets in human space. ComStar has stated that before the Schism it had actively staffed over 200 of Terra's 500 SLDF bases, and the Com Guards were built out of SLDF stockpiles. Today, Terra's once-vast military factories have been resurrected and are feeding the Word's war effort. The losses of the mighty Wolf's Dragoons and Com Guards at Mars and Terra, respectively, suggest the defenses there are very potent.

## LUNA

**Noble Ruler:** President of the Terran Congress Chris Windsor-Cameron

**Position in System:** 3 (Moon of Terra)

**Time to Jump Point:** 9.12 days

**Surface Gravity:** 0.166

**Atm. Pressure:** Vacuum

**Equatorial Temperature:** -173°C (night), 117°C (day)

**Surface Water:** 0 Percent

**Highest Native Life:** None

**Population:** 3,200,000

**Socio-Industrial Levels:** A (Advanced)-B-C-C-B

**Affiliation:** Word of Blake

Humans first set foot on Terra's only moon Luna on 20 July 1969, barely eight years after they first entered space. It would be another fifty years, though, before humanity settled on Luna to stay. The newly formed (Western) Alliance Space Command had just settled into its orbital headquarters of Crippen Station before it was tasked to permanently settle Luna in 2016. This was accomplished before the year was out. The highly expensive crash program to settle the moon was driven by the Alliance's high hopes for Luna's industrialization and militarization. Little of this manifested as changing technology, particularly the development of high thrust fusion rockets, rendered its advantages moot without fixing its disadvantages of low gravity and hydrogen shortage.

After development sputtered fitfully for decades, Luna became most popular for its role as a resort. Terrans often enjoyed a low gravity vacation while gazing back at their beautiful across Luna's silvery plains. In the 2300s, the nascent Terran Hegemony relocated the headquarters of its bureaucracy ("Office of Administration") to Luna in hopes of isolating its bureaucrats from undue political influence. To keep the civil servants healthy, Luna's older rotating habitats were scaled up to gravdecks as much as five kilometers in diameter. These largest of habitats were mostly abandoned in the twenty-sixth century as generations of exiled bureaucrats managed to transfer themselves back to Terra. Today, the abandoned OoA Warrens are popular destinations for historians and tourists.

Tourism remains the primary industry of Luna. Some three million inhabitants are mostly employed in resort cities like Armstrong City and the capital, Luna City. Depending on the jurisdiction, entertainments at lunar resort cities range from child-friendly theme parks to vibrant, shameless adult resorts, all eager to empty the bank accounts of millions of visiting tourists. A small minority of the population work in the aerospace business, mostly interplanetary shipping, and staff Luna's military facilities, which help guard near-Terran space with their fighters and SDS missile launchers.

Today, Luna is administrated as a district of Terra, the mines

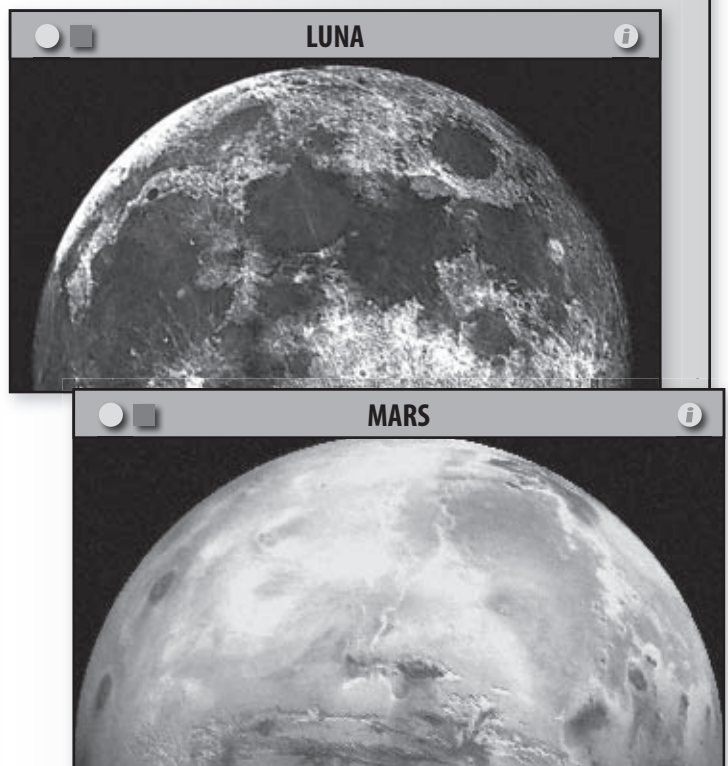





## THE WORLDS OF MANKIND'S HOME

are few (being overshadowed by Mercury and the Asteroid Belt), the industry limited to specialty aerospace components, and the only excitement seems to be at the several Nearside resort cities. If war comes to Terra, though, the military spaceports and SDS capital missile launchers of Luna will likely play a key role in defending near-Terran space.

**MARS**

**Noble Ruler:** Precentor Martial Cameron St. Jamais

**Position in System:** 4

**Time to Jump Point:** 9.15 days

**Number of Satellites:** 2 (Phobos, Deimos)

**Surface Gravity:** 0.38

**Atm. Pressure:** Thin (Breathable)

**Equatorial Temperature:** 12°C (Arid)

**Surface Water:** 39 Percent

**Highest Native Life:** None

**Population:** 4,250,000

**Socio-Industrial Levels:** A (Advanced)-B-A-C-B

**Affiliation:** Word of Blake

By the middle of the 21st century, dreams of making Mars habitable seemed more like viable engineering projects than dreams. The necessary studies of Mars and Venus began in the late 21st century, and in 2110 (with Project Lowell, on Mars) the Terran Alliance began unleashing engineered microbes, mosses, fungi, and hard technology to begin taming Terra's sisters. In a mere century, it was possible for humans to breathe unaided and unsheltered on the surface of Mars. No other terraforming project conducted since then was as extensive as those of Mars and Venus because other projects tamed marginally habitable planets. And while many worlds, including Venus, would depend on continuous technological support like atmosphere processors or weather control satellites, Mars' new environment would survive untended for millions of years.

To the frustration of the visionaries who pushed for Mars' terraforming, few settled the world. The low gravity—the lowest of any habitable world in human space—was unhealthy. The terraformed ecology was still developing and centuries away from the foretold picturesque garden. (As a whole, Mars never became that garden, though the Grand Canal and coastal areas are quite lush.) As a result, Mars came to be inhabited primarily by two groups: miners, who could work easily in the habitable environment and found so many ore deposits untouched by the weathering of a Terran-like oxygen-rich atmosphere; and the ultra-wealthy, who sought the exotic, low-gravity vistas of Mars. At the peak of the Star League, merely 70 million people inhabited a world next door to Terra, then crowded with 12 billion.

Because many of the Terran Hegemony's rich and powerful sided with Stephen Amaris against the incompetence of Richard Cameron, Mars was sharply depopulated within a few years

of being "freed." The miners continued their work, feeding ComStar's Terra with the ores the system needed to survive. It is noted that the recent *Notable Players* publication placed the modern Martian population at one million, which is only correct if one counts the permanent residents. However, the population is over four million when one counts the transient miner and ComStar/Word of Blake administrator population.

Mars has received the first significant terraforming "touch-ups" performed in centuries. The dry crust of Mars had been steadily draining the Hellas Sea and Northern Ocean since they were first filled, and the southern icecap had been growing significantly. These changes were burdening mining operations with higher operating costs (even forcing the use of domed cities), so the Word of Blake performed a number of low-cost terraforming programs. The Phobos Skyhook, a key element of Hegemony ecosystem "fine tuning," was revived to deliver countless gigatons of cometary water onto Mars without shattering impacts, while vast beds of terraforming microbes and plants were sown again. Slight increases in atmospheric density (to 720 millibars) with Titanian nitrogen and cometary moisture have warmed Mars by a few degrees, arresting the growth and albedo-based cooling effect of the southern icecap. These low-cost terraforming projects secured the loyalty of the miners and other inhabitants, who were thrilled to see an end to ComStar's neglect.

Mars supports the Word of Blake war effort in other ways. In recent years, it seems apparent that Mars is some sort of regional administrative center for WoB and large numbers of bureaucrats have been brought in to run the Word's Protectorate. Also, the Star League-era War Academy of Mars (WAM) was revived and is now thought to be turning out classes of loyal Blakist soldiers.

**VENUS**

**Noble Ruler:** N/A

**Position in System:** 2

**Time to Jump Point:** 9.11 days

**Number of Satellites:** 0

**Surface Gravity:** 0.904G

**Atm. Pressure:** Very High (Toxic)

**Equatorial Temperature:** 250°C

**Surface Water:** 30 Percent

**Highest Native Life:** None

**Population:** 0

**Socio-Industrial Levels:** N/A

**Affiliation:** Word of Blake

Like Mars, mankind had imagined Venus to be a twin of Terra. As late second millennium astronomers obtained more detailed information on the world, the dreams were only heightened. Constant cloud cover on pre-terraforming Venus inspired visions of oceans, sweltering heat, and a jungle- or swamp-like environment. Early space exploration, though, dashed these

## THE WORLDS OF MANKIND'S HOME

dreams. Venus was not merely sweltering, it was a furnace with a 460°C surface temperature that was wrapped in a 90-bar blanket of carbon dioxide, nitrogen, and sulfuric acid. Even its rotation was miserable, its day longer than its year.

With much of the same propaganda that terraformed Mars, the Terran Alliance lay siege to Venus's seemingly insurmountable problems with Project Aphrodite. Beginning in the late 2100s, Venus was assaulted by airborne algae that began taming the thick atmosphere. Hydrogen was added first by re-directed comets, and then in more controlled shipments from Titan. The innermost planet of the Terran system, Mercury, became the scene of truly massive mining operations that supplied calcium, which was fed to terraforming algae, which sequestered Venus's carbon dioxide atmosphere as limestone. Excess atmosphere also supplied the reaction mass to accelerate Venus's spin to a forty-eight-hour day. In less than a century, Venus was habitable to humans. No engineering project before or since then has been as grand as the efforts that tamed Venus.

Unlike dry and frigid Mars, Venus proved to be a popular destination for colonists. In 2245, colonist Timothy Gothic had noted the nitrogen-rich chemicals covering Venus's land (rained out during efforts to sequester Venus's excess nitrogen) made excellent fertilizer. When a way to manufacture artificial soil was invented (allowing an end to the import of Terran soil), Venus became an agricultural cornerstone of the Terran Alliance. It fed the Terran system and several nearby colonies. Like Mars, it came to host a military academy, the Academy of Aphros.

But the Terran Alliance and Hegemony took shortcuts in making Venus habitable. The planet ended up with too much surface water, making the terraformed world darker and prone to retaining too much solar warmth, and its upper crust retained far too much heat from its pre-terraforming days. Aggressive and continuous atmospheric reprocessing was used to keep the planet habitable, as were periodic deployments of a planetary-scale sunshade near the Sol-Venus L1 Lagrange point. The sunshade was destroyed in one of Amaris's loonier schemes (he had hoped to incinerate entire fleets with focused

sunlight, but the sunshade collapsed in the ill-conceived attempt to reconfigure it). ComStar used poorly supported economic arguments to scuttle any attempts to rebuild the sunshade or provide proper maintenance for the atmospheric processors; the ultimate reasoning behind this preventable tragedy is not known.

What is known is the outcome of ComStar's neglect. Pre-terraforming Venus enlightened humanity to the "greenhouse effect." In the 30th and 31st centuries, Terrans had a front row seat to watch a truly runaway planetary greenhouse effect. As the decay became inevitable, Venus's population was slowly evacuated to Terra through the 2900s until only a few thousand remained in 3000. The sudden failure of the last atmospheric processors led to increased water evaporation and, water being a powerful greenhouse gas, this warmed the planet at an exponential rate. Contrary to some recent reports, Venus actually retains freestanding oceans (which are rapidly acidifying as they dissolve the vast carbonate beds), but only because the 45-bar atmosphere (mostly of steam) is able to suppress evaporation at the average temperature of over two hundred Celsius. The evaporation process is likely to continue into the next century, when Venus's atmospheric pressure will greatly exceed that of its pre-terraforming state. What happens as nitrogen and carbon dioxide are freed from their sequestration is a matter of ghoulish speculation by planetologists.

## TITAN

**Noble Ruler:** Precentor Gregory Zwick

**Position in System:** 6 (moon of Saturn)

**Time to Jump Point:** 10.66 days

**Surface Gravity:** 0.14G

**Atm. Pressure:** High (Toxic)

**Equatorial Temperature:** -180°C

**Surface Water:** 0 Percent

**Highest Native Life:** None

**Population:** 300

**Socio-Industrial Levels:** A (Advanced)-B-D-C-B

**Affiliation:** Word of Blake

Titan is the largest moon of Saturn, Terra-VI, and was noted in the mid-20th century as having a substantial atmosphere and being exceptionally large. This made it unusual amongst the moons of Terra's siblings, though Titan is now eponymous for the "Titanian-class" of worlds recognized by modern planetologists. Titan did not quite capture the imagination of mankind as Mars and Venus and was not known in antiquity because it was not visible to the naked eye from Terra, but it did fascinate astronomers. The 10AU separation between Terra and Titan prevented manned exploration until the development of fusion rockets in the late 2020s, when the Alliance Space Command launched the "Great Journeys" missions throughout the Terran system. Titan received a

## VENUS

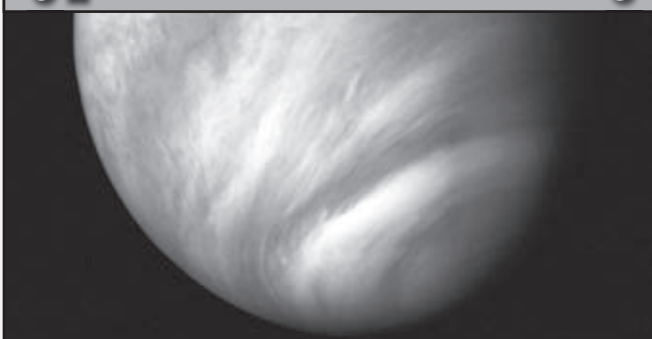



## THE WORLDS OF MANKIND'S HOME

## TITAN

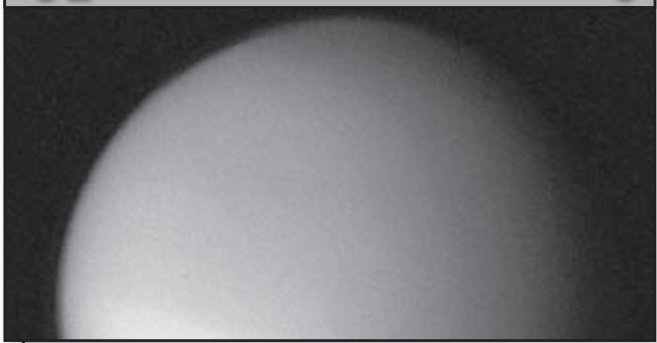

permanent manned base on 29 January 2042 that would host up to 100 visiting scientists at a time that explored its then-exotic hydrocarbon sludge-lakes (which cover about 15 percent of the moon's surface), dense nitrogen-methane atmosphere, and search for "extremophile life."

Titan was destined to be little more than an object of scientific study until Projects Lowell and Aphrodite demanded huge amounts of water, hydrogen, and carbon to build viable biospheres. Both twenty-second century terraforming projects initially utilized comets, but comets were found to be unreliable sources of volatile compounds, often rich in unwanted substances like carbon monoxide. Titan, though, had all the necessary substances in abundance, and in a more predictable, reliable position than random comets. Vast amounts of Titanian nitrogen, water, and hydrocarbons were delivered to Mars, and water and hydrocarbons were sent to Venus.

After three generations of supporting the giant terraforming projects, Titan had developed a sizable population and huge space-based industrial base that faced economic ruin in the early 2200s because, simply, their job was done. While that day was well-anticipated, Titanian operations had been such a "cash cow" that the Titanian corporations (and their pet Alliance parliamentarians) were not going to let those assets be liquidated and well-paid voters go unemployed. Instead, Titan found a new calling: building JumpShips.

While the Saturnian moon system was not particularly rich in resources necessary for ship construction, it was close to Sol's proximity limit. On the other hand, Titan was deep in Saturn's gravity well, which protected the shipyards from accidental jumps, and few of the Saturnian moons generated permanent Lagrange L1 jump points other than Titan (making defense simple and raiding hard). Titan's conversion of its mammoth space-based factories to shipyard production came at a critical time as mankind's desire to colonize the stars, now backed by a century of pioneering efforts, was increasing exponentially. The prolific and efficient Titan Shipyards drove down ship prices and provided a glut of affordable JumpShips in the early 2200s (coincidentally about the time the Alliance was eager to export dissidents).

These shipyards survived the Liberation of Terra in relatively good shape (thanks to turncoats in the Amaris management who sided with Kerensky) and aided the great post-Liberation evacuation of Terra. ComStar, however, largely shutdown the Shipyards in the late 2790s to avoid attracting House raiders. For reasons only known to the First Circuit, the Titanian Shipyards were never allowed to produce more than a trickle of JumpShips (and a handful of WarShips), not even when ComStar's reputation and inviolability reached a peak in the JumpShip-starved Third Succession War. It was not until the Schism that ComStar attempted to revive the nearly mothballed yards, a process that only came to fruition under the Word of Blake. If they can be captured intact, the Titan Shipyards have an unparalleled shipbuilding capacity that could quickly restore the Jihad-ravaged merchant fleets of the Inner Sphere.

Today, only a few hundred people live permanently on Titan, and most are recent immigrants who assisted in the Mars terraforming "repairs." Another 30,000 personnel live and work in the string of factories and giant shipyards that orbit low over Titan's equator.

## TERRAN ASTEROID AND KUIPER BELTS

**Ruler:** Metis Commission

**Position in System:** See text

**Highest Native Life:** None

**Population:** 1,500,000,000

**Socio-Industrial Levels:** A (Advanced)-A-A-A-A

**Affiliation:** Word of Blake (notional)

Terra's asteroid belt, located between Mars (Terra-IV) and Jupiter (Terra-V), is perhaps the most insular and isolated region of the Terran system. Its isolationism began long before ComStar attempted to shield Terra from the Inner Sphere, arguably about in 2200 when mining on interstellar colony planets became more economical than mining in the vacuum, radiation, and micro-gravity of asteroids. This was a hard change from the 21st century, when resource-starved Terra turned to the Belt to answer its mineral starvation and the Belt was the foundation of the Terran economy.

## ASTEROID AND KUIPER BELTS



## THE WORLDS OF MANKIND'S HOME



While Belters did “come out of their shells” during the late Age of War and Star League era to supply exceptional crewman and spacecraft to the Hegemony, the Amaris Coup treated them poorly. The Belters living in the Sol-Jupiter “Trojan” asteroid clusters, which hosted large shipyards, were often beset by Caspar raids, and the least bit of resistance to an Amaris-appointed overseer would get an entire colony destroyed. Between Liberation and ComStar’s seizure of Terra, the Belters had resumed their isolationism and established a formidable aerospace defense force that discouraged ComStar from trying to stringently assert BoTA’s authority over the Belt. Other than to maintain the system’s isolation, ComStar asked little of the Belt.

In the early 3060s, it was hoped that Belters might help throw the Word out of the Terran system, but the Word has respected the Belter’s autonomy (and elite fighter units) and is even a good trade partner particularly since the Titan Shipyards were resurrected, so the Belters do not seem to particularly care about the Word’s actions abroad. Oddly, some Belters have reported that the Word’s relaxation of Inner Sphere media import restrictions for the Belt won over many Belter hearts.

The Belt is not actually limited to Terra’s asteroid belt. By the

Star League, there was extensive development of the Jovian Spartan and Trojan asteroid clusters (which now host several hundred million Belters). Amaris’s excesses drove the settlement the distant Kuiper Belt beyond Neptune (where perhaps a hundred million reside on the icy planetoids) and the Terran Oort Cloud on the fringes of the system (where about thirty million Belters have settled.)

Belters live in some of the largest artificial structures ever built. Except for the “homesteaders” carving out tunnel warrens in newly claimed asteroids, most Belters live in giant, rotating habitats excavated into huge chambers within an asteroid or free-flying stations near an asteroid being stripped for raw materials. (They do not inhabit domes or other surface structures, instead seeking the radiation and micro-meteorite protection of heaped soil.) These habitats are typically giant cylinders or toruses (some, as on Metis, over ten kilometers in diameter), with much of the interior open space serving as manicured parkland and estates of the wealthy. Much of the Belt’s industry is given to expansion of living space as the population is growing at a slow but steady rate, but there are so much excess industry and mineral resources that the Belters live very comfortable lives within these habitats.

are now broken into districts that are clumps of pre-Hegemony internal divisions, like North America’s “New England” district, which consists of eight of the old USA’s “states.”)

Religion is similarly diverse—Terra is far from uniformly Blakist. Indeed, less than ten percent of Terrans (as of a 3058 poll) claimed Blakism as their only religion. Another fifteen percent claim to follow the precepts of Blake’s Word as a supplement to more traditional religions. (Blakism, after all, is more of a philosophy espousing sensible use of technology to better mankind than a religion. It does not address the afterlife, God, and other matters usually reserved for religions.) The remaining third of Terrans who claim to pray or attend church regularly are divided amongst the major religions that can be found in the Inner Sphere: Christianity, Islam, Judaism, Buddhism, etc. However, with the exception of Blakism, off-world religions (e.g., the One Star Faith or New Avalon Catholic Church) have found very few adherents on Terra. Terra is particularly notable as the homeworld of these major religions and has a number of sites of great religious importance to humans throughout the Inner Sphere, like Jerusalem, Vatican City, Mecca, and more. The Word of Blake earned the enmity of many of the Inner Sphere’s Muslims for closing Mecca to pilgrims after ComStar had granted access for six years in the 3050s (not that other than a few wealthy Muslims could visit Mecca during the “Focht Thaw” for lack of JumpShip transport).

**GOVERNMENT: THE BRANCH OF TERRAN AFFAIRS**

Among the worlds of human space, Terra has a relatively unique government that is hard to describe in conventional terms like “republic,” or “aristocracy,” or “dictatorship.” It is not, despite some propaganda claims, a theocracy or Primus-ruled dictatorship. The term that fits best is probably “bureaucracy.” The “Branch of Terran Affairs” (BoTA) is a part of the Word of Blake (formerly ComStar) that might be most easily imagined as all the bureaucracies a typical government of the Inner Sphere possesses, minus distinctive executive and legislative branches. A small “Cabinet” of the heads of BoTA departments makes policy decisions to address problems (recessions, natural disasters, etc.) and to implement broad directives from ComStar (or the Word of Blake).

BoTA is a modern, professional civil service based on the finest lessons of Terran Hegemony managerial theory. It has sufficient checks and balances to avoid becoming a dictatorship or oligarchy; the powers of department heads are carefully delineated to avoid abuse, and a competent internal affairs department (actually separate from ROM) prevented significant corruption. Advancement is generally meritocratic, as in the early Hegemony. BoTA’s departments are typical of a modern government: Education, Health, Housing, Treasury, Agriculture and Environment, Transportation, etc. It is seated in the ancient Terran capital of Geneva.



## TOURING TERRA TERRAN PEOPLE



Cabinet policy decisions were then implemented at the district level. District governments serve to coordinate policing, taxation, and provide social and municipal services. Unlike the federal Terran Alliance and Hegemony, BoTA is a “unitary” government with no separation of powers between districts and the “central” government in Geneva—the districts are simply convenient administrative zones to manage the billions of Terrans. District governments have some flexibility to implement the policies owing to differing local conditions, but ultimately answered to Geneva.

Democratic input from Terra’s population is largely restricted to the level of cities and towns, where some officials can be elected—ComStar and the Word of Blake were both uninterested in letting Terrans dictate planetary- or district-level policies. Each BoTA department also has “ombudsman” mechanisms for accepting input from the population, like suggestions for improvement and complaints of abuse. These ombudsman offices were most responsive to individuals and organizations with significant economic clout—i.e., corporations and the wealthy. One of BoTA’s permanent directives was to keep Terrans prosperous, happy, and docile, and it did this by trying to avoid economic hardships. Therefore, when a corporation worried that a BoTA policy was hurting business, BoTA listened. It might not agree, but it took input seriously.

In the ComStar Reformation, Primus Mori created the “Terran Assembly,” an unicameral advisory body to the Cabinet that was staffed with representatives directly elected by the population at the district level, with the number of representatives based on district populations. The Assembly’s guidance to the Cabinet was much in the same vein as that of directives from the First Circuit: policy directives that the Cabinet implemented as it saw fit. Unlike the First Circuit’s input, though, the Cabinet was free to ignore the input of the Assembly. The Word of Blake suspended the Assembly in 3058 and appointed Precentor Martial Trent Arian as temporary military governor of Terra. To outsiders’ surprise, the Word of Blake reinstated the Assembly as the Terran

Congress in 3064. This appears to have been in response to steady input from Terran leaders and corporations, who offered the Word of Blake new means of implementing Blake’s vision. The Terran Congress has actual legislative abilities, to which the Cabinet is obligated to implement directly. Like the Terran Hegemony, representatives of the Congress serve two-year probationary terms before beginning eight-year regular terms. The Congress elects a “President” from its members to be a head of government. (Head of state duties remain the province of the Cabinet and whatever alliance of chief Precentors the Word of Blake can patch together, or perhaps the mysterious “Master.”) The first and current President of the Terran Congress is from the district of England, Duke Christopher Windsor-Cameron.

It might seem odd that the Word of Blake would grant such power to Terrans, just as it might seem odd that pre-Reformation ComStar did not rule Terra with a theocratic iron fist, but there are a number of practical reasons for this “leniency.” The first is practicality. ComStar had issues similar to a monarchy: its Primuses would rule for years, perhaps decades, and the ruled population had no official recourse to deal with abuse. A Primus that frequently intervened in government was likely to quickly anger the population with poor (or at least irritating) decisions but was not going to retire after a predictable term, unlike an elected official with more moderate terms in office. This could quickly drive a situation toward insurrection as happened in the late twenty-ninth century. Therefore, the Primus handed direct authority, responsibility, and blame for governance to a proxy, the Branch of Terran Affairs. A similar situation can be seen in the Combine, where the Coordinator rarely exercises direct power over the population, instead allowing nobles to implement the Coordinator’s “suggestions.” The Coordinator, then, is blameless if something goes wrong—the noble clearly misunderstood what the Coordinator had implied.

The other practical aspect is that ComStar had spent 250 years rebuilding Terra. Its people were wealthy, very well educated, and sat on a mountain of industry. It was an oasis of

## TERRAN PEOPLE

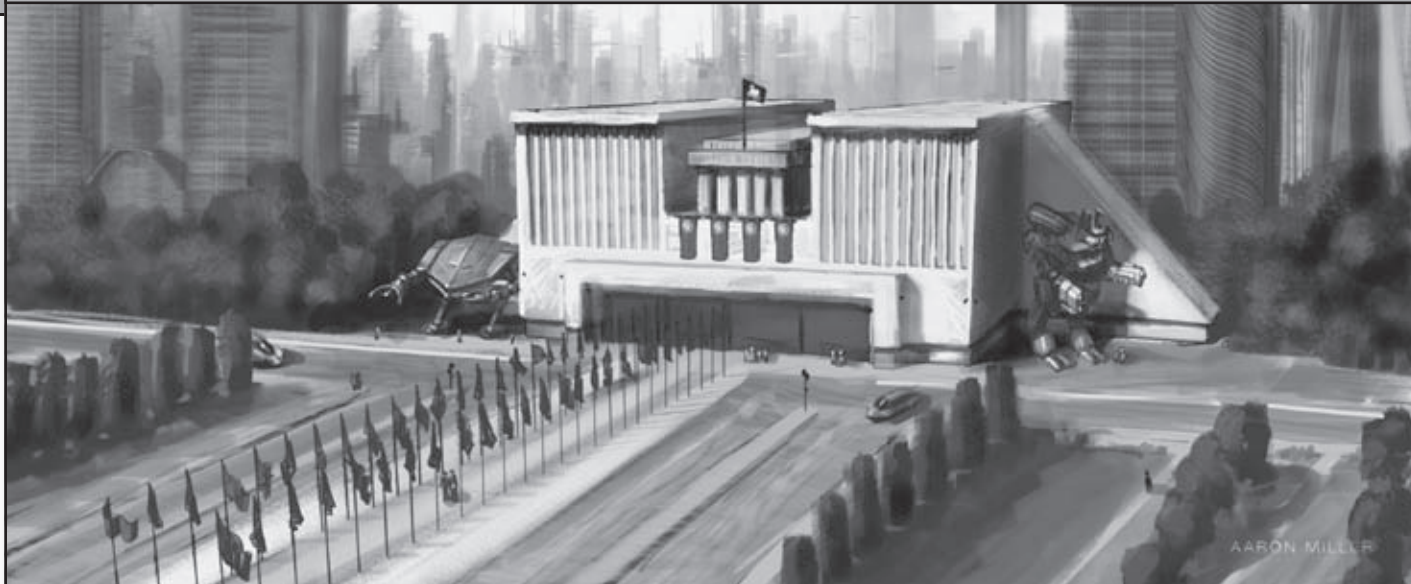

“lostech” during the Succession Wars and, if its military products were not quite as advanced as those of the Clans, it had a depth and breadth to its scientific knowledge that has not been seen since the fall of the First Star League. And for all of ComStar’s wealth (it should not be forgotten that ComStar was more than “the HPG mystic-guys,” but also ran many planetary postal services, telecommunication networks, computer networks, and media companies, and was a massive financial institution), Terra’s economy still represented a near-equal even though it was posed as a mere “branch” of ComStar’s operations. In short, Terrans formed a slumbering beast that would have been very difficult for ComStar to control once awakened. Were ComStar to regularly irritate Terrans by directly governing them, it likely would have found itself reprising the role of the Terran Alliance government in 2315.

Since the Word of Blake has enlisted Terrans in its Jihad, it has had to accommodate their wishes to some extent. Hence, the Terran Congress is not entirely a puppet of the Word, nor is Duke Windsor-Cameron entirely a Blakist toady. He does walk a fine line between bettering Terra, aiding the Word, and avoiding a shallow, unmarked grave courtesy of ROM.

The topic of Duke Windsor-Cameron brings up another issue: Terran nobility. The nobility of the Star League era is almost entirely absent from Terra owing to post-Liberation purges and has no official authority *per se*. Some districts (specifically Japan, Thailand, Monaco, England, and Sweden) retain noble leaders who are treated as district governors who inherit their position rather than being appointed by the Cabinet, though they remain subject to normal BoTA regulations of any district governor. Other nobles may have land and wealth on Terra, but the only legal difference (as far as BoTA is concerned) between them and common wealthy landowners is a paper title that is inherited with their other possessions. For example, being Duke of England did

not earn Windsor-Cameron his position as President of the Terran Congress; he was elected by the Congress (primarily because he was willing to accept a role that would put him in closer contact with the Word’s leadership than other representatives wanted). Being a Windsor did make him Duke of England, but his Cameron heritage is moot - he and his ancestors form a cadet branch of the Camerons who had no claim on the Star League throne.

Another means of avoiding a general Terran insurrection was ROM. For most of Terra’s post-Star League history, ROM provided common law enforcement as well as hunting down subversives, Terran nationalists, and insurrectionists. ROM did a good very good job at this, but it was well-supported by ComStar propaganda (the Succession Wars provided endless examples of how lucky Terrans were to have ComStar, and ComStar made sure they believed it) and honest economic prosperity. After the ComStar Reformation, policing was turned over to TerraSec. The Word of Blake brought its ROM back, but it has not taken general law enforcement duties away from TerraSec.

Interestingly, TerraSec seems to have evolved in the past ten years. Finding a lack of cooperation (or at least information sharing) from ROM when it came to interstellar intelligence gathering, BoTA has apparently tasked TerraSec with spy operations in the Protectorate and beyond. As an organization, it is a novice, but TerraSec has been able to hire many retired ROM agents and draw on the intelligence personnel of Protectorate planetary governments to form a functional, if not exceptional, spy agency.

### ECONOMY

The common portrayal of Terra during the Succession Wars was that of a world shrouded in mystery and isolated from the Inner Sphere. While visits to the worlds of the Terran system were restricted, Terra was not entirely isolated—far from it. Terra’s



## TOURING TERRA

central location and proximity to the most industrialized worlds of the Inner Sphere made it a natural trade hub. As a result, its zenith and nadir jump points host huge entrepôt space stations where merchants from all nations (until recently) traded and held negotiations often mediated by ComStar. Under the Word of Blake, visiting JumpShips are required to first dock with the nadir (Brandenburg) or zenith (Versailles) recharge stations for inspection before conducting commerce.

Terra is also a very industrialized world. The dearth of JumpShips in the modern era restricted Terra's interstellar trade activities as it did everywhere else, but Terra manufactured all manner of goods for export. Notably, the Federated Suns was long a major buyer of military goods from the Aldis Corporation, the inheritor of the few Terran arms factories ComStar left open during the Succession Wars. Terran goods were not particularly more advanced or higher in quality than those available from advanced Inner Sphere worlds like Tharkad or New Avalon, but the cachet of "Made on Terra" allowed Terran goods to sell at a premium.

Before the ComStar Reformation, many wondered at the dichotomy of reports of lostech in use on Terra as opposed to the high (but not unusual) technology of Terran export goods, but the matter seems clearer now: old ComStar eagerly looked forward to the collapse of the Inner Sphere civilization, whereupon it could step in to save humanity. ComStar was not going to export fusion engines by the shipload or, for that matter, unleash its shipyards to replace the JumpShips lost to the Succession Wars. Even innocuous devices like noteputers were subject to rigorous restrictions on the technology they could contain.

Despite such a thriving manufacturing sector (now no doubt enlarged by the needs of the Jihad), few Terrans work with factories; far more are engineers or managers, and even they are not too numerous. Terra's thundering factories are typical of those of advanced worlds around the Inner Sphere: mostly automated, isolated away from housing districts, clean, and often underground. Few Terrans are needed to staff manufacturing companies. Agriculture is likewise heavily automated except for hobbyist operations. Most Terrans are thus involved in service industry jobs, where they labor for twenty to thirty hours a week before spending their earnings on Terra's wide range of leisure activities.

The Terran System is unusual for its high level of space development, easily greater than any other system settled by mankind despite the loss of an entire planet, Venus, to the failure of a terraformed environment. Terra-I, Mercury, currently conducts mining operations at its north pole (which also host some Mercury's rare water deposits), which feed some heavy metals to the system's economy. Mercury competes with Martian miners, trading a harsher environment for less expensive energy—focused sunlight supplies industrial heating with less complicated equipment than conventional fusion power plants, or so the backers of the Hermes Industrial

Complex claim. HIC is a pale shadow of Mercury's 23rd century glory, when it sent countless gigatons of calcium to Venus to sequester that world's original carbon dioxide atmosphere as limestone. Terra-II, Venus, used to be an agricultural world that fed a dozen nearby star systems, but Amaris's foolish destruction of its sunshade and ComStar's inexplicable refusal to reconstruct the sunshade left Venus to broil while the House Lords steadily destroyed the JumpShips that would have carried its food abroad. By 3000, most of Venus's agriculture production for the Terran system had shifted to Terra's green fields. Terra-III-a, Terra's moon Luna, is a primary recreation destination for many Terrans on long weekend vacations. It hosts several major gambling and adult entertainment cities that empty tens of millions of Terran bank accounts annually. Terra-IV, Mars, has been a mining center since it was opened to settlement in 2200 and remains such, competing against Mercury for Terran markets. Due to the terraformed environment, Martian mining operations are less costly than those of Mercury, but Mercury has diversified into more sophisticated industrial operations than just mining. Mars also seems to be a major Word administrative center; ROM is known to be based at Koryo. Titan, one of dozens of Terra-VI's (Saturn's) moons, hosts dozens of space stations orbiting in its equator. These form the Titan Shipyards, which have spent more than a decade coming to life to feed the Word of Blake Militia's largecraft needs. Titan itself only has a few hundred inhabitants left after a surge in activities in the 3060s, when Titanian nitrogen was shipped to Mars to thicken that world's atmosphere as parts of the Word's efforts to shore up Mars' ailing terraforming. Beyond these primary developments, there are a dozen more research facilities, private vacation homes, and exploratory industrial operations throughout the Terran system...and the Asteroid Belt.

Located between Mars and Jupiter (Terra-V) is the "Main Belt," a modest asteroid belt that was heavily settled in the twenty-first through twenty-third centuries, and all but abandoned by the end of the twenty-third century in favor of cheaper interstellar mining operations. Much of the colonists remained, though, and gradually rebuilt their shattered economy through internal growth. The Belters (a term that also includes the asteroid clusters of Jupiter's solar L4 and L5 points and the Terran Kuiper Belt and Oort Cloud) are exceedingly isolationist from the rest of the Terran system (and human space). Until the Titan Shipyards were revived, their primary exports to Terra were a trickle of rare metals (like the platinum group metals) and exceptionally well made spacecraft ranging from smallcraft to JumpShips, while importing entertainment and luxury goods. Most Belter economic activity is internal, and they seem quite self sufficient. Most Belter industrial surplus is spent on expanding their population and settling more asteroids, Kuiper worldlets, and Oort comets, where they build the largest known space-based habitats in human space.

## TOURING TERRA

Excepting the odd Belters, who are virtually a world apart from the rest of Terran system, Terra remains the hub of the system's economic activity. Terra has, literally, 99.9 percent of the system's population beyond the Belt (and Mars' 4 million inhabitants account for 90 percent of the remainder). Interplanetary space travel is prolific, but the commerce conducted by those ships is a shadow of the vast wealth that shuttles about on Terra's railways and oceans.

### LIFE ON TERRA

Interviews with captured Terran-born Word of Blake Militia personnel indicate that Terra has gained some sense of paranoia and a siege mentality as the Houses encroach on the Word's main stronghold. There is also anger at the Word of Blake. Despite years of tight information control, Terrans have built a fairly clear picture of the conflict in which they participate. Notably, it seems commonly accepted on Terra that the Word of Blake struck first in the Jihad and, even if the cause of preserving the Star League was righteous, the early strategy of "punishing the infidels until they obey 'the Master'" is regarded as moronic. But with no military force other than the carefully controlled Word of Blake Militia, Terrans can do little.

Otherwise, life continues on Terra much as it always has since the fall of the first Star League. As in most modern conflicts, only a small part of the population is involved, so most people go about their day to day lives as farmers, doctors, artists, technicians, and other trades. Working from home is common thanks to the advanced telecommunications and short work weeks. Terrans live in a world pervasively filled with computers

and robotic assistants, a situation not seen elsewhere since the fall of the first Star League.

Their lives are conducted on a magnificent world rich in heritage and, well, actual wealth. The shining metropoli of Terra are almost uniformly older than any other settled planet, thick with art, monuments, and ancient buildings. Major Terran corporations roost in skyscrapers like the Chrysler Building and Empire State Building that were ancient when the Inner Sphere's major business centers, like Tharkad and Atreus, were the rawest hovels, and these ancient buildings sit shoulder-to-shoulder with the products of the Star League, new towers funded by the mid-thirty-first century economic boom of the Inner Sphere, and some structures even dating to the First Millennium or earlier. Around the Mediterranean Basin, millions of Terrans see structures three and five thousand years old on a daily basis.

And they usually see those sights for many days. Terrans are beneficiaries of the most advanced medical knowledge in human space except for perhaps the Clans' trauma medicine. While Terran medical knowledge has not advanced much beyond that of the Star League, it is still sufficient to keep the average Terran alive for 150 years. Middle age among Terrans is usually considered to reach until the 110s or so; many adults start their families in their 70s and 80s, when they've completed a couple of careers, mastered life lessons through a few marriages, and built up a substantial financial portfolio to provide for their families.

With intelligent software to handle efficient paperwork, and with extensive automation to handle grunt labor, Terrans are both highly productive (based on the amount of work accomplished per worker) and tend toward short work weeks. Much of their

## TERRAN PEOPLE







## TOURING TERRA

daily lives are filled with family and leisurely pursuits—Terrans are great sports players and hobbyists, and more than a few while their lives away in vast computer universes. Productivity is so high and necessities are so inexpensive that it is easy for BoTA to universally supply education through to university, basic health care, housing, unemployment, and other common social services without heavy taxation.

Indeed, a full twenty percent of the population is what employed Terrans sarcastically dub, “the leisurely employed”—employable adults who claim difficulty finding work because of the extensive automation and happily subsist on welfare stipends while pursuing affordable entertainment. The “leisurely employed” do have some solid evidence, though, behind their claims of “forced” unemployment: “full time” employment (20 or more hours a week) is in short supply on Terra, thanks to automation replacing many of the jobs handled by humans on other worlds. Often lumped into the “leisurely employed” are those who have retired young, often before 100 years of age, on a wisely accumulated investment portfolio, or their heirs who were born to that wealth.

### TRANSPORTATION

Some of Terra’s wealth can be understood in its transportation.

The world is covered in networks for high speed maglevs and local railways in the dense cities. Surface streets in Terran cities are mostly the province of pedestrians, bicyclists, and very patient car drivers, while light rail either races overhead or under the streets. Long distance maglev trains have all but eliminated short haul (under 1500km) large aircraft and are preferred over cars for intercity travel in South America, Australia, and Europe. These advanced trains often race between cities on raised rails at better than 500kph, and may sprint at barely subsonic speeds in open lands or the great undersea tunnels that web Europe to North America (via Iceland), North America to Asia (via Alaska), and Europe to Africa (via Gibraltar and Sicily/Tunisia).

Cities and rural towns are webbed together by all-weather paved roads. Many Terrans in North America, Asia, and Africa own cars, which are primarily fusion powered (a Terran is regarded as poor and desperate by his fellows if he resorts to a battery- or solar-powered car), and have advanced autopilots that can handle most road conditions. Only in the most rural areas are drivers forced to endure the tedium of manual control, while on the major expressways (which have no speed limits) manual control is fortunately forbidden. The autopilot system does coordinate locally with nearby cars and more distantly to central traffic control, producing very smooth flowing traffic at high volumes that would produce jams on most other worlds.

The wealthy (and there are many wealthy individuals on Terra) often own fusion-powered VTOLs or fixed wing aircraft, depending on advanced autopilots to effortlessly fly them

between cities, continents, or from rural manors to urban offices. Larger fixed wing aircraft are less common on Terra than some planets, relegated to intercontinental business travelers by the extensive high-speed maglev network, commonality of VTOLs, and large number of airships. Particularly fast “jet setters” use smallcraft and DropShips for truly rapid intercontinental flight. The more leisurely use airships, which have reached epic scales on post-Star League Terra. The ability to haul hundreds or thousands of tons of freight and hover motionless over a city without thundering fusion rockets makes them much preferred over DropShips for freight transport, while their grace and ability to hover over beauty spots makes them popular for aerial cruise lines.

## CHILDREN OF GAIA

### Lunarians

Despite a relatively small population, Lunarians are a diverse people with several regional cultures. Luna is an airless moon 3,500km in diameter, giving it a low gravity and harsh environment that makes it difficult to survive in small groups, so the over 99 percent of the population lives in major cities on Luna’s “Nearside” (Luna is tidally locked to face Terra, hence “Nearside” and “Farside” hemispheres.) Other significant population clusters are the Word of Blake military bases and the vast Tsiolkovskiy-Fermi Astronomy Facility (which hosts the largest optical telescope ever built by man) on the little-inhabited Farside. These latter facilities have little in the way of permanent population to develop any culture.

The cities of Luna are each quite unique. About their only architectural commonality are the large gravdeck habitats that circle each city core; these differ from spacecraft gravdecks by having a distinct outward curve to balance local gravity with spin-induced gravity.

Armstrong City hosts a large spaceport and modest industrial facilities in and around its track habitats, a sea of industrial-ugly vacuum facilities. It is a working town proud of its long (if modest) contributions to Terra’s aerospace industry and the work it does to “keep all the casino thieves and prostitutes alive,” by supporting the infrastructure of the resort cities.

The capital, Luna City, consists of several soaring towers (government offices and low-G hotels) based on fantastic pre-spaceflight science fiction artwork, and is surrounded by fifteen 2km ring habitats that once housed hundreds of thousands of Hegemony OoA bureaucrats. Only a couple of the habitats are active today, housing Luna City’s population of administrators, financiers, and trickle of tourists exploring the OoA “ruins.” Luna City is the white collar counterpart to Armstrong City, full of bankers and civil servants working 10- and 12-hour days.

## CHILDREN OF GAIA

Kepler and Imbrium are two resort cities that cater to families and romantics uninterested in the, well, raunchier delights of the other resort cities. Kepler plays on pre-spaceflight ideas of “moon men” aliens and underground lunar civilizations, building several large theme parks inside its ring-habitats (each park keyed to a different storyline and completely different architecture and “moon men”). Common areas outside the ring habitats and theme parks make great use of masonry in the underground tunnels. Imbrium is dedicated to the arts: it hosts the grandest dance shows of Luna, a couple of artist colonies, museums, and huge domed parks on the surface that exploit the low gravity (and centuries of sculpting) to be marvels of the Inner Sphere. (The domes also grow most of Luna’s staple foods, with Terra supplying luxuries.)

Tycho, Copernicus and New Vegas offer varying degrees adult entertainment. All three making gambling a key part of their economy, intermixed with the other usual casino resort diversions: theme parks, risqué dance shows, dining, etc. Tycho is deemed the “most uptight” as it bans prostitution and encourages families to visit, but the level of alcohol and recreational pharmaceutical use and amount of casinos (second only to New Vegas) set it apart from Kepler and Imbrium. New Vegas unashamedly caters to gambling and all manner of vices including prostitution, but the government is clean and crime is low. Copernicus has been called “New Vegas’s shadow,” and its businesses are usually staffed by down-on-their-luck Lunarians. Copernicus offers wilder gambling, stronger drugs, and more perverse erotica than New Vegas (going so far as to use very lifelike animated mannequins for activities that would be illegal elsewhere). Copernicus’s police are easily bought off and the government is hard to differentiate from a crime syndicate. Tourists are usually safe, but there is a higher level of mugging and assault than elsewhere on Luna.

### Martians

Mars was settled by three groups of people: miners, the ultra-wealthy, and the service industry that supported the ultra-wealthy. By 2750, some 70 million people permanently inhabited Mars, about 5 million of them miners and “Martians” who embraced the exotic, low gravity planet. After the purges in the last years of the Hegemony, Mars was abandoned by the wealthy and the tourist industry. The world became the primary source of minerals for ComStar’s Terra, even delivering inexpensive ores like iron and aluminum to make up for the losses in the efficient recycling programs of Terra and Venus. ComStar also based some administrative centers on Mars and operated the War Academy of Mars as a Com Guard training center. Under the Word of Blake, these uses have expanded - it is known that the domed city of Koryo houses the Word of Blake’s ROM.

The culture of Mars, then, is based on these groups. The temporarily-assigned Word of Blake administrators and spies

keep to themselves during their tours. The miners, who also generally only work on Mars for a couple of years before returning to a healthier gravity, form a typically rough-and-tumble mining town culture: they spend back-breaking days in climate-controlled command centers, remotely overseeing the giant robots that do most of the actual mining, and work up a powerful thirst that they quench in Mars’ plentiful bars and brothels. (The robot mechanics and on-site mining personnel, i.e., the miners who get their hands dirty, are higher up the pecking order in these dens than the “computer jockeys.”) Drawn from all across Terra, the miners have little in the way of common culture other than “Terran generic.”

The permanent population of Mars is much smaller than the transient. About 1 million people permanently call Mars their home today, including a quarter million being rural farmers and nomads. The urban Martians differ little from the Terran norm and are heavily influenced by the multitude of visiting miners, differing from the latter in that they tend to be far less rowdy. Urban Martians tend to work in managerial or infrastructure positions, rather than catering to all the whims of the miners - that is, they own or oversee the mines, bars, and brothels rather than work in them, or work in the Martian civil service, utilities, and the like. All Martians tend to be protective of their women around foreign males because of the heavy gender imbalance amongst the miners (generally about 4:1 for the past two centuries.)

The rural Martians tend to own the large, automated farms that feed the miners and keep Mars independent of imported food, though a minority embraces a nomadic lifestyle. The rural farms are often owned by a *de facto* nobility - the great Martian mine owners often own the farms to control the planet’s food supply, so visitors should be cautious about mistaking a Martian farmer for a “rural hick.” Quite likely the farmer is an inheritor of a centuries-old estate and mining corporation with a university education and a private security force to keep her mines in good order and provide lessons in good manners to visitors. The nomads, meanwhile, embrace Mars’ vistas and do not want to be trapped by the “rigid corporate lives” of the mining industry or towns. They are philosophers in the “Way of Mars,” which seems to be largely based on anti-terraforming propaganda from the late twenty-first century. Despite Bedouin-like mannerisms (in fact, the nomads deliberately mimic Terran nomad cultures), few nomadic Martians overtly adhere to any religion. Farmers and nomads alike are generally very modern sorts - nomad children are educated on noteputers tied into the planetary network, and portable fusion generators are common items (assuming the nomads do not own fusion-powered vehicles).

Martians have an unusual “native” language that seems to have evolved from the polyglot of languages used by early miners. This English-based creole was considered roughly standardized by 2600 (interestingly, it was a tourist agency that “standardized” Martian so it could easily teach its employees a



## CHILDREN OF GAIA

convincing “native dialect” to entertain tourists) and has since developed a modest body of literature. It is taught as a primary language in Martian schools, with Star League Standard English the usual secondary. The language is used to help Martians stay distinct from the flux of miners and protect their privacy.

It was noted that, historically, native Martians tended to be somewhat taller than normal, distinctly thin (in both bone and muscle), dependent on low gravity medical supplements, and often unable to stand long in normal gravity. They also rarely lived past a century despite medications. This has changed since the Amaris Coup. Martians now tend to exhibit normal bone strength, height, and health, and transition easily to 1G environments; they do tend to be weaker than most humans. This change seems to have manifested after a widespread “vaccination” campaign run by the Belters c2820, but Martian records on this medical campaign are suspiciously absent.

**Venusians**

Some millions of Venusians are still alive, but they are not on Venus. Instead, they are found on Terra where they evacuated during the thirtieth century. Venusians differed culturally little from Terrans because there was a great deal of travel between both worlds, and many “Venusians” were simply Terrans with summer homes on sunny, tropical Venus. Most Venusians simply disappeared back into the Terran population, though a few formed political and financial groups to attempt to rebuild the Venusian sunshade. These Venusians tend to obsess over ComStar’s decision to not rebuild the sunshade and propose all manner of grandiose conspiracy theories. The ComStar Reformation and opening of the Halls of History gave them endless amounts of material to feed their imaginations, but few firm answers.

**Titanians**

Through the late twenty-eighth century, Saturn’s large moon Titan held a substantial population in orbit. In the twenty-second century, the moon had developed beyond small scientific bases during Projects Lowell and Aphrodite when it began feeding nitrogen, hydrogen, carbon, and other materials to Mars and Venus, efforts requiring tens of thousands of workers laboring for decades. The habitat stations hosted the workers and their families, which were generally influenced by the trends of Terran culture with typical “spacer” influences (primarily a mindset of safety and emergency skills for the hazards of living in space). Few lived on Titan’s surface—except for maintenance work on the vast mining and launching facilities, all the work was in space. There, specialized shipyards and processing facilities would send packages of needed elements and compounds to Mars and Venus.

Titan was almost depopulated when Projects Lowell and Aphrodite were ended, but the corporate owners were able to secure Terran Alliance bridge loans to convert the huge shipyards

and trained workforce to JumpShip construction. While Titan was not ideal for the task (the Saturn moon system lacked most of the raw materials needed for JumpShip construction), it did begin producing JumpShips in prodigious quantities—a final nail in the coffin of Belter mining operations, as interstellar mines on habitable planets soon had enough transport to deliver refined metals back to Terra. The importance of the Titan Shipyards rose and fell over the next few centuries with the vagaries of competition and economies, but it was not until the twenty-ninth century that most activity at the Shipyards ended. The Shipyards had largely been spared damage in the Star League Civil War and had spent the 2780s producing JumpShips and DropShips at a ferocious rate to meet the Terran need to evacuate their despoiled home. The First Succession War, though, halted the flight of Terrans. Shortly thereafter, ComStar put severe restrictions on JumpShip production and only maintained a small skeleton staff at the Shipyards. The Titanians were dispersed by forced unemployment, mostly resettling in the Belt or on Luna.

The tens of thousands of workers currently orbiting Titan (and the few hundred remaining in the great surface mines) are recent immigrants hired by ComStar and now employed by the Word of Blake. They were tasked to take the Shipyards out of mothballs and begin production, something they have done well. A majority are Terrans with prior experience at the O’Neill Shipyards or the large DropShip fleets of Terran system, but some thousand are Belters drawn by the high pay.

**Belters**

The Terran Asteroid Belt was one of the first great extraterrestrial colonization efforts of mankind. Starting in 2031, mankind began settling the Belt not just with scientists and laborers, but entire families. Laden with patriotic idealism, the colonists began rapidly developing the Belt and soon prospered as they answered exhausted Terra’s resource shortages. In the following decades, the Belt developed huge freefall factories and enabled great technological advances in fusion power and shipbuilding, which filled the Belters with enormous pride. The Belt’s own developments, like inexpensive JumpShip construction, served to destroy the Belt’s economic competitiveness. By 2200, it was easier and cheaper to mine interstellar, habitable planets than the Belt. The Belt’s economy imploded and the universe seemed to turn its back on the Belters.

Terra’s increasingly autocratic behavior and cultural dilution in the twenty-third century encouraged further isolationism by the Belters who, having been raised on steady diet of national pride from the major Alliance member-states that developed the Belt (Brazil, France, USA, China), could not relate to their homeland. Refugees from McKenna’s coup brought new money and bodies to the Belt, allowing Belters to recover from the deep and lasting recession of the twenty-third century. Though nominally run by the Terran Hegemony after 2336, the Belt was

## CHILDREN OF GAIA

self-sufficient and able to largely ignore its Terran “masters” who, in turn, did not bother Belters so long as taxes were paid.

The Belters came out of their self-imposed isolationism during the Star League, providing many a spaceship crewman and operating many sizable shipyards. Their mineral resources might have been expensive to export, but they were masters of zero-G industry.

The Star League Civil War was a scarring experience for the Belters. Just as Simon Cameron seemed likely to endorse relatively affordable, automated asteroid mining, he was assassinated during a tour of a Rim Worlds’ asteroid mine. Within two decades, the Terran system was under Amaris’s boot, and Amaris did not like the autonomy of the Belters. When Belters expressed reservations about selling ships to the Amaris-run Hegemony, Amaris initiated “travel curfews” by CASPAR drones that mauled Belter shipping and destroyed habitats for the least bit of resistance. The Jovian Trojan and Spartan asteroid clusters (settled by the French and Chinese, respectively) were especially hard hit and, post-Liberation, provided most of the initial Belter emigration to Terra’s Kuiper Belt and Oort Cloud.

After Liberation, the Belters retreated into an armed isolationism, favoring internal growth by “homesteading” to exports. Major habitats were protected by heavy weaponry and fighter-based militia units were common. ComStar was only able to exert any control (via BoTA) on matters of foreign policy and exports, the only topics on which ComStar would risk conflict. Otherwise, ROM and BoTA governors found the proliferation of firearms and bladed weapons amongst the Belter citizenry (and a blasé attitude about using those weapons, giving the Belters’ extremely advanced medical knowledge) to be a deterrent to closer governance of the Belters.

Trying to deal with the Belters in an official capacity can be confusing, as underneath the weak central government of the Metis Commission (which in turn answers to the Branch of Terran Affairs) are four major governments derived from the colonial administrations of the Terran Alliance member-states that first settled the Belt. These “Big Four” actually handle most of the day-to-day administration and defense of the Belt, though the Metis Commission oversees the far flung independent “homesteads” of the Kuiper Belt and Oort Cloud. The Word of Blake, like ComStar, leaves the Belters alone so long as they follow BOTAs trade and diplomatic policies.

Today, Belters are noted for being a refined and sedate group of cultures modeled on the “High Terran Alliance” period of the mid-22nd century. The inhabitants of the Main Belt (primarily

American and Brazilian) are fairly democratic, ruled by elected officials who—taking a cue from James McKenna’s reforms—have long office terms and do not seem to have term limits. Incumbent politicians thus become fixtures in government with decades in office. The Chinese and French asteroid clusters are notionally democratic, but limit the franchise to habitat owners. Belter politics are sedate, polite, and conducted by officials who act as if they have all the time in world to settle policy questions (they act quickly in emergencies, but lawmaking is a relaxed affair amongst the Belters.) Visitors find the whole Belter government system charmingly quaint, like something from a Terran Alliance docu-drama.

While the government is quaint, the culture is not backward. Belters are well educated and live in a very technological environment—and the most sheltered Belter is probably as good a spacer as a veteran Inner Sphere spacecraft crewman. Except for raw homesteads that have not yet built gravdecks, most Belters live in spacious 1G habitats with huge parklands and private estates (real estate sales in new major habitats often pay for the entire construction cost). The particulars of daily life differ somewhat between the “Big Four,” but are generally similar to Terran urban life: most people work in service industries and a minority in the bountiful manufacturing, mining, and agricultural industries.

Despite a proliferation of firearms (Main Belt) and bladed weapons (most other Belter habitats), the dueling culture is primarily non-lethal and—currently—has encouraged a Belt-wide culture of politeness and genteel behavior. Most disputes are settled verbally or by receiving the input of a respected elder (or landowner, in the Trojan Clusters and many independent habitats.) Another common cross-cultural goal in the Belt is homesteading. Many Belters grow up dreaming of staking a claim to a new asteroid and developing a colony on it, with the eventual goal of ruling over an extended, thriving clan and industrial base by the time they retire.

Though the matter is poorly discussed by Terrans (probably because of its taboo nature), one of the Belters’ primary sources of friction with ComStar and the Word of Blake is not their isolationism but rather human genetic engineering, which would bring friction with any foreign government as well. Much-exaggerated reports of major genetic engineering for cosmetic purposes have never been confirmed despite a flurry of investigations, and the Belters simply appear to be healthy people born to an environment with medical knowledge equal to or superior to that of the Star League’s finest.



## TOURING TERRA

## THE FREE MARS MOVEMENT

The aftermath of the bloodiest war humanity ever witnessed forced many changes in every corner of the Inner Sphere, none more prominent than Sol's system. Once the bastion and home of Word of Blake, prior to them ComStar, the citizens of Terra and Mars suffered unimaginable horrors at the hands of Stone's coalition and the Blakist in a fight to the death.

Undoubtedly Terra suffered the most catastrophic damage ever witnessed, Mars suffered an equally amount of horror, though on a smaller scale. The history of Mars is filled with tragedy and suffering. The "*Red Planet's*" transformation from a lifeless world to an ecologically sound planetary body wasn't accomplished over night. That took centuries of hard labor and love by those who accepted the challenge to turn the planet into a living world.

The Martians are a hearty and robust people. They live in a hostile environment that could kill a person as a bullet can. During Star League, Mars earned many accolades and special projects boosting their economy rivaling any world in the Inner Sphere. However, during the Amaris years, Mars suffered immense damage nearly wrecking its ecosystem and economy. Yet, the Martian people did not give up. They began rebuilding and flourished under the guidance of ComStar.

Under the Blakist regime, many Martians reclaimed their glory days and their booming economy. When Stone's coalition invaded Mars, the people joined in the defense of their home. The battle to control the "*Red Planet*" proved costly for both side, more so for the Martians as many of their homes and cities suffered cataclysmic damage thanks to WMDs and the wanton destruction from the opposing forces. After the Blakist forces capitulated and peace finally descended, the Martians set about doing what they have done in the past after such disasters happened; began rebuilding.

However, there was a fundamental shift in the attitude of these tough folk. They did not like the changes Stone's new government brought to their world, chaffing under its rule. They believe under Blakist control, they had it far better. They are a proud people who governed themselves since their founding. Stone's demand to give up a measure of their personal freedom prompted calls for revolt and form their own government. Thus was born the Free Mars Movement. Though militant in nature, they've not overtly acted against the government. They do demonstrate almost every day with banners and calls for the repressive regime to dissolve. Only time will tell where this will go; however, it is rumored that a number of the movement's members are former Blakist veterans. Should that prove true, Mars' government may have some serious issues to deal with in the future.

As on many water-rich worlds, the bulk of Terra's freight is shipped by water. Giant robotic ships of Avalonmax and Malaccamax efficiently move freight between continents, while smaller units continue millennia-old shipments through major rivers and artificial seaways. Specialist submersible freighters compete with the open-ocean giant surface ships via the "Northwest Passage" (an intercontinental shortcut under the frozen ocean of Terra's north pole) and to service underwater resorts in tropical regions.

## TERRA: A FUTURE?

I have witnessed the conclusion of hostilities on Terra today, when the BoTA Cabinet signed a cooperation treaty in the district capital of New York City. Devlin Stone seems to be minding his history and is intent on working with the Terran government rather than purging it (or letting the Terrans lynch too much of it), though I assume changes will be afoot. Stone has indicated that he hopes to preserve Terra "for all mankind," and he's confided in me that he is confident the Terrans will not prove to be a hotbed of Blakism that will require a long-term occupation force.

## NO LOVE FOR BLAKE

I agree when on the matter of Blakism. I have had the misfortune to see the crimes the Word of Blake committed on Terra alone, never mind the rest of the Protectorate, and have no doubt that once Terrans see the Word's records and hear the upcoming testimony in the Geneva Trials that few, if any, Terrans will continue to support the old regime. As I noted in my pamphlet an eternity ago—was it just 3077?—most Terrans found the Word of Blake to be allies of convenience, and ones who stopped being useful allies when the Blakists brought a Jihad against the Inner Sphere. The Terrans wanted a revived Hegemony, not a genocidal war.

Right now, many common Terrans, perhaps a third if the opinion polls can be believed, still favor the Word, but that support is plummeting. Newly resigned President of the Terran Congress, Duke Christopher Windsor-Cameron, has spared no time sharing with the Terran public the Blakist horrors he was powerless to stop, and his stories have been confirmed by a few surviving Word of Blake Militia officers and Terran Congress representatives. His most damning revelation was that all nuclear weapons used on Terra, including the salted abominations, were used by the Word of Blake. And I do mean all of them, even those previously blamed on the Com Guards. The Duke is a smart man and clever politician, but I do not think he has realized his attempts at denouncing the Word of Blake and showing how he (and most of the Terran government) did not participate have only raised Terran ire. After all, the Duke has confirmed that the Terran Congress knew of Blakist crimes but did not lift a finger to stop them.

## TOURING TERRA

### THE GENEVA TRIALS

One of Devlin Stone's frequently debated decisions was the declaration that there would be "Trials, to be hosted at Geneva, for the purpose of achieving a measure of justice for all who suffered at the hands of the Word of Blake."

This declaration created numerous difficulties, many of which were operational in nature. While Terra was pacified, numerous worlds were still under control by Word of Blake forces. This meant that accused criminals and victims of many crimes were not available, and access to evidence from those worlds of any crimes was limited. Further, transporting the hundreds, sometimes thousands, of prisoners presented a significant logistic problem, with interstellar transport still heavily stressed, and adequate forces to safely and properly transport any prisoners were in very small supply.

The problems were also political in nature; several of the allies of the Coalition were extremely reluctant to hand over any Blakist prisoners as they would lose access to the knowledge the prisoners possessed. In some cases, there was reluctance to yield the application of justice for crimes inflicted on a nation's subjects to an outside authority, especially a fledgling one with debatable

moral high ground. Finally, numerous entities were concerned that cooperation with the Geneva Trials would expose them to subsequent attempts to try allied personnel for any crimes committed during the war against the Word of Blake. Attempts to try 'Coalition war criminals' could be used by both foreign and domestic enemies.

The legal problems were also not inconsequential. There was a lot of concern that the proposed trials were an attempt at 'victor's justice', as was frequently perpetrated across the Inner Sphere. Other concerns hinged on the Trials leading to ex post facto creation of laws, and of the relaxing of the requirements of burden of proof. Evidence of actual crimes was extremely fragmentary, as the Word of Blake had done an excellent job of destroying data on many worlds they abandoned, not the least of which being Terra. In many cases, any crimes could only be inferred through the responsibility of command, or through negligence to prevent crimes from being executed. Finally, the only basis of law under which the Trials could be executed were the laws and treaties accepted by the Second Star League, which ceased to exist as a legal entity just before the start of the jihad. Further,

the Second Star League had many strong tenets intended to prevent legal invasion of or conflict with member-state sovereignty. A basis for an trial on international law was almost non-existent without application of ex post facto law.

Finally, the Geneva Trials proved to be a subject of considerable friction within Stone's own ranks, with Belle Lee frequently and vocally opposing the "hypocrisy", while David Lear was a major proponent and champion of the process.

Of considerable interest and note should be that several Word of Blake prisoners were in favor of the Trials as a means of atonement and repentance. Most prominent among them was David Alsace, who publicly stated that "These Geneva Trials, while doubtlessly imperfect and inevitably controversial, are a necessary step. I do not doubt that they will lead to the end of my life as a human being. But as a human being, I see an urgent need for a healing of the wounds caused by this conflict. The Trials are and will be an indispensable tool towards that end, and the public must forgive it its many flaws in light of this purpose.

I yield to the Trials willingly."  
—From "Creating a Republic: War's Disruptive Effects" by Dr. Helga Jörgendottir

At least he mostly exonerated the Cabinet, so when the Terrans stop lynching collaborators there will be a functional planetary government.

Having been on Terra for several months now at the request of Stone, who wanted a professional historian's eye on these events, I am personally *almost* glad that there are still robe-wearing Blakists on Terra. They are lightning rods for Terran anger at the atrocities wrought in the last months of Liberation. (Or "The Invasion," as Terrans call it.) I intellectually understand that the hard line Blakist leadership truly thought in terms of "burning Terra to save it from defilement," but having seen the aftermath...I can't understand it. I cannot conceive of soldiers defending a world resorting to *salted* nuclear weapons on their own heavily populated areas in an effort to destroy the invaders. Modern nuclear weapons are free of fissionables, so when you airburst them over an enemy the lingering radioactivity is an inconvenience for a few days. But the

Word of Blake used cobalt-jacketed weapons to destroy a Coalition staging base in the Dallas-Ft. Worth region. With the five-year half-life of cobalt-60, it will be a half century before the region's farms and cities are inhabitable again. I have seen the blackened land of Texas. I know the scorching was only from wildfires after the nuclear explosions, but with a screaming dosimeter in my ear it was hard not to think that the entire land was scorched by nuclear fire. St. Jamais used weapons in his last stand that, I'm told, apparently had improvised zinc jackets, and that produced clouds of zinc-65 to drift on the winds to North America's extremely productive agricultural region, the "Midwest." The zinc salting produces even more intense radiation, though the lands should be safe again within ten to fifteen years.

As awful as those salted weapons were, the final "strategic" doomsday bombardment killed tens of millions outright as it hit the dense metropoli of North America's East Coast, Mexico,



## TOURING TERRA

and California. These weapons were mercifully not salted, but the explosions were ground bursts that kicked up plenty of fallout anyway. Many of the blast survivors suffered radiation poisoning as they drank contaminated water or breathed contaminated air. And the panicked mobs of refugees fled to neighboring, undamaged cities. Coalition troops did not intervene, thinking it unacceptable to hurt civilians, but that “humanitarian” gesture actually made matters worse. The refugees pillaged surviving farms and warehouses while collapsing transportation networks, creating yet more famine and death until local Terran police...stopped...the refugees. They mostly used small arms, but some surviving TerraSec units were able to field *Firestarters*. Relief efforts are now gaining ground, but it looks like the one-year death toll from the final bombardment will be about 100 million, and only half of that is from direct effects of the nuclear attacks. I’m writing this from New York because the Cabinet has made Manhattan (the urban core of ancient New York City, untouched by nuclear weapons) its base of operations for the North American relief effort and would not leave to sign in more symbolic areas like Geneva or Unity City.

The Liberation more than scarred Terra’s people and cities, it scarred the land. This is most clear on Hilton Head Island. It’s now just a ring of radioactive, muddy islets surrounding a deep crater in the Atlantic seabed. It appears that a subterranean blast estimated at fifty megatons destroyed the island. Weapons that size have not been used since the First Succession War. The bomb does not seem to have been salted, but the underground explosion heaved millions of tons of activated sand and bedrock into the air. Between that and

a dozen burning cities, the whole planet is suffering from a “nuclear autumn,” a mild nuclear winter. In the longer term, all the dust and aerosols in the upper atmosphere will be hard on Terra’s ozone layer.

## NO LOVE FOR THE COALITION

Now aware that these nuclear attacks came from their erstwhile allies and masters, the Terrans are definitely not going to support the Word of Blake in the future. The Inner Sphere need not worry about that. But the Inner Sphere troops on Terra have worries aplenty. Every House calls the Coalition troops liberators; the Terrans and people of the Protectorate call them invaders, barbarians, and worse. Devlin Stone seems to get resigned cooperation from the Terran government, but I think his hopes for a Terra open to all of mankind is overly optimistic. And I have trouble seeing how any House is going to get the worlds of the Protectorate to return to their fold short of violent invasion and long-term suppression of insurrection.

It is not universally true that the Protectorate worlds exhibit hate toward their liberators. Some, of course, were either brutally conquered by Word forces when they were happily members of a House, or were treated poorly by Blakists after they joined the Protectorate. (I mean, more poorly than other Protectorate members; toward the end, many worlds found politicians, community leaders, and dissidents disappearing.) But many of the Core Worlds are less than appreciative of their rescue—they did not want the Word, but they are not happy with their liberators.

Why? To a properly-raised citizen of the Inner Sphere (particularly in certain Houses that are heavier on ideological schooling than others), are not the Core Worlds some of the most

## TERRAN FUTURE?



## TOURIN

valued members of a House? They are, after all, the industrial core of the Inner Sphere, prized and protected for their wealth and populations. The Houses saved them from the defunct Hegemony; some Hegemony worlds actively sought House suzerainty in the First Succession Wars. Many House citizens have immigrated to those worlds to make better lives for themselves and form communities of loyalists. So why are there acts of violence and even small insurrections against liberating Coalition troops?

The perspective of the Core Worlds is rather different than those of their former Houses at large. To them, the Inner Sphere first killed the Star League with their refusal to select a new First Lord, drove away Kerensky (who also gets little love from the Core Worlds for running off into the Periphery), and then sundered their great union, the Hegemony. After that, the Inner Sphere then spent two hundred fifty years fighting to the death over the ex-Hegemony worlds. And most of those fights to the death were on the Core Worlds. Factories were plundered, cities bombed, and entire planetary populations killed by failing technology. Houses installed garrisons to keep the peace and, in some cases, unleashed secret police to keep the populations quiet. Just as the Inner Sphere seemed to settle down some in the early thirty-first century, the Federated Commonwealth Alliance thundered through the Core Worlds in one of the most violent conflicts in one hundred fifty years. Then the area was thrown into disarray as the planets were abandoned into what was known as the Chaos March. Terra and the Word of Blake came calling with the vision of a new union, something to help these worlds return to greatness. They were finally given a new option that did not involve subjugation to one House or another, but a chance to choose their own futures.

And then the Houses destroyed the Star League *again*, leading to yet more destruction on the Core Worlds and Terra.

As a historian, I would point out that the worlds of the Hegemony had a hand in collapsing the first Star League by aiding Amaris, or at least by not resisting him, and had a hand in the Hegemony's collapse by methodically destroying their own government while seeking revenge. A fair and balanced view, though, does not carry much weight in the former Protectorate right now.

If there is to be any hope of these worlds recovering soon, they might need something new, something other than returning to their Houses. Honestly, I am concerned for the House émigré communities on the Core Worlds—they may need to be relocated, as angry as the natives are. Attacks on Coalition troops are a daily occurrence, though mostly in the form of knifings or shootings, not organized resistance.

### TERRA: IN THE SHORT TERM

Terra has minded the history of the First Succession War and its many nuclear bombardments. The Branch of Terran Affairs—I wonder how long that name will last—has implemented the

## HOUSE STONE?

(27 January 3079)

Terra [INN] — The level of violence since Sekkaris and Cairo were secured earlier this month has remained low. There are reports of only sporadic violence and attacks by small guerilla-style cells, rather than full-scale military operations.

In this relative calm, some observers are trying to define the void left in war's wake. There are some who feel ComStar should inherit Terra. Others have remarked on the rumors emanating from the various Taskforces, which would have victorious generals return home to assume new roles of leadership. Such rumors also frequently bring up the possibility of a new First Lord, legitimized by conquest of Terra.

If there is any truth to such reasoning, and some say there is, then it is difficult to overlook Devlin Stone himself. Few can argue that he has been instrumental not just in brokering the coalition that put an end to the conflict, but also in leading the troops to victory personally. Truly, the accomplishments of the man are amazing given the few short years they have been achieved in. Certainly, part of the credit goes to the people he attracts to his side, but as has been said, judge a leader not by his deeds, but by his followers.

It comes as no surprise that the established nobility has wasted few opportunities casting doubts on the suitability of Stone in a role of permanent responsibility. It is not clear from whose House he originates, or whether he came from a House at all. But there can be no doubt that he has gathered an incredible amount of influence and political momentum that would make him a terrifying opponent of any House in almost any capacity. That his suitability to rule is questioned then becomes a matter of self-preservation. Or, perhaps, of maintaining the status quo.

After all, there are also many who note, correctly, that the real question isn't to whom Stone will yield his allegiance to after the jihad has ended. The question is, will he yield at all? Some say, he will not, and that creates an intriguing possibility. Could Stone intend to *start* a dynasty? Are we to witness the birth of House Stone?

Certainly, each of the Great Houses couldn't have hoped for more noble and impressive beginnings. Some would argue that Stone's accomplishments have far exceeded those of most founders of the Great Houses. The public support for such a dynasty would be high. Regardless of such a path, there is no denying that he is the most eligible bachelor of the Inner Sphere bar none.

Regardless of Stone's intentions, if House Stone is to govern Terra, he will certainly have his work cut out for him.

appropriate cold-blooded responses to the catastrophic damage. Instead of trying to succor every nuclear-bombed, BattleMech-ravaged city and accomplishing nothing, it is concentrating its resources where they can have some useful effect. This usually meant containing the tens of millions of Terrans in nuclear-



**THE BLAKIST UNDERGROUND**

(2 February 3079)

Terra [INN]: News tonight from newly-liberated Terra. While countless citizens of the Inner Sphere breathe a sigh of relief that the madness of the Word of Blake's campaign of terror has been ended, citizens of Terra itself are facing a very different and frightening future. Held under the thumb of the Word of Blake for over two decades, many native Terrans view Devlin Stone's allied forces as an armed occupation force. Far from liberators, they view the coalition as invaders and tyrants poised to destroy the lives they have known and cherished.

Security forces remain on high alert. In every corner of the Terran globe snipers, suicide bombers and armed insurgents make desperate attacks against coalition troops and civilian population centers. Other citizens, still shocked from the scope of violence caused by the invasion, refuse to aid security forces in their search for these self-styled "resistance cells". As these random attacks grow in scope and frequency Devlin Stone and his advisors will be forced to make critical decisions about the future of Terra's population.

Beyond the violence and chaos caused by these attacks a deeper question must be asked. What has the Word of Blake forced these people to endure that has inspired such fanatical loyalty? Is this some massed form of "Stockholm Syndrome" where those held hostage begin to feel a connection to their abductors? Or is it possibly something more insidious? Did the Word of Blake manage to subjugate the Terrans to their warped and violent view of the Inner Sphere? Can such damage ever truly be undone?

The military phase of Terra's liberation may now be complete. The war for hearts and minds however, has just begun.

damaged areas and leaving them to fend for themselves so they did not flood into neighboring areas and collapse those, too. The situation almost got out of hand in North America and caused a worse humanitarian catastrophe, but was halted. I can still see the scorched barricades around and inside New York City, where entire blocks were burned to the ground to control looting refugee mobs—the earlier damage from several BattleMech battles is arguably not as extensive. BoTA estimates that, globally, about five hundred million have died.

The draconian measures worked. The planetary transportation network is now moving freight again rather than being clogged by refugees, and patches around shattered nexi like Chicago and St. Louis are complete. The injured refugees are no longer a burden; they are simply dead, leaving that much more medicine, food, and shelter for the healthy. BoTA has implemented rationing and emergency expansions of farms to replace the fallout-poisoned agriculture of North America. If not for the nuclear autumn hindering farm productivity, Terra would no longer be drawing on its wartime food stockpiles (which seem to have been started after Case White).

**NG TERRA**

What's left of Terran civilian industry is in full swing and growing, producing terraforming robots to filter soil and the first giant air processors are under construction to eventually cleanse the atmosphere and restore the failing ozone layer. Factories of many types have been reconfigured to produce personal, home and vehicular air filters to protect the population from the haze of fallout from the salted bombs. Medicine to treat radiation poisoning is treated almost like a daily vitamin supplement in some parts of North America; many lines of consumer drugs have been suspended while vital medicines are produced. (I had the misfortune to see a fellow Lyran, a "social general," suggest there was a near-term export opportunity for those so-advanced, side effect-free Terran radiation medicines. It's amazing the sort of injuries that a Terran manufacturing executive can inflict with a ruler and a paperclip.) One of BoTA's contributions to organizing this industrial expansion is to distribute machinery and specifications for "garage" manufacturers. The "leisurely employed" have taken up this new "entertainment" in great numbers and are actually producing significant quantities of medicines, air filters, and other vital equipment from their benchtop fabricators. Housing, of course, is another major product of retooled Terran factories. There are tens, if not hundreds of millions of refugees to house. The speed of Terran construction robots assembling new apartment towers in shattered Los Angeles, Mexico City, Boston, and other nuclear-ravaged cities is astounding and something that should be exported throughout the Inner Sphere.

I haven't quite seen anything like the Terran space industry. A remarkable clean-up of near-Terran space has been underway for months, with mass-produced laser satellites burning down paint chips, bolts, shards, and other small debris while smallcraft and DropShips collect the millions of tons of wrecked shipping and satellites from the battles. You no longer need a military DropShip to safely visit or depart from Terra. The O'Neill and Titan Shipyards are wrecked, but the enigmatic Belters are rapidly expanding their shipyards now that ComStar and the Word are not suppressing Terran JumpShip production—the output they hope to achieve in a decade sounds like a fairy tale (or an annual report from an old Star League shipyard). Those JumpShips will be in high demand because the fleets and shipyards of the Inner Sphere are devastated at a time when JumpShips are needed in greater quantities than ever. Devlin Stone also speaks of plans to send incredible numbers of Terrans abroad to help rebuild former Protectorate worlds.

Terra is well on its way to repairing the damage of the Jihad, though the scars will linger for decades. Beyond that, though, I cannot predict what will become of the world. It is no longer muzzled by ComStar or the Word, but has been crippled. The new Star League is gone, but after the horrors of the Jihad, can mankind afford not to reform such a moderating body? For a while, at least, we have had unity of purpose again in the

## TERRAN FUTURE?



Coalition, and we now have a respected, central world that could once again host a reborn Star League. If not, the whole Core of the Inner Sphere may lapse back into chaos, as it was in the early 3060s. Devlin Stone is another issue. The man united us when we needed unity and guided us when we needed focus on a nearly insane foe, but he has seemingly taken root on Terra. He has

moved Coalition field quarters to permanent offices in Geneva and is in the process of organizing a war crimes trial in that city, whether the Terrans want to host it or not. I have to wonder what his plans for Terra are.

—Bertram Habeas, 11 February 3079





## RULES ANNEX

## RULES ANNEX

The following section provides additional rules for *BattleTech* covering new units and equipment pertinent to this phase of the Jihad.

**Terminology:** In these rules, the term “unit” is used as it is in *Total Warfare (TW)*, to refer to a single battlefield element, such as a DropShip, aerospace fighter, Mobile Structure, and so on.

## WORD OF BLAKE SDS NETWORK

The Terran Hegemony’s Reagan Space Defense System (SDS) Network was one of its most memorable technological achievements. Designed to allow the Hegemony to defend from all-out invasion, the SDS network enabled Stefan Amaris to hold Kerensky’s entire navy at bay for years. The mixture of robotic fighters and surveillance satellites, space and ground based capital-scale defense platforms, and the infamous M-5 *Caspar* drones devastated over eighty percent of the SLDF forces that sought to liberate Terra from the Usurper. Other nations developed similar SDS systems, but none could ever match the technological perfection of the Hegemony’s.

The Word of Blake came very close.

The Word’s efforts to replicate the SDS systems of Terra were first suspected in the aftermath of the Wolf’s Dragoons’ failed assault on Mars. Any skeptics of the Blakist advancements in this field were dispelled in June of 3076 at Rochelle. One of the earliest targets of the Coalition’s advance into Protectorate space, a successful reconnaissance mission uncovered the existence of an orbital tracking system tied to dozens of capital missile-equipped satellites (or what were thought to be satellites at the time) and shut it down before the main assault. Had the system been fully operational, Devlin Stone would likely have perished before his campaign of liberation ever truly began. Fate was not so kind to the Confederation’s *Franco Martell*. It is now known that the *Martell* ran afoul of a fully functioning *Caspar II* orbital defense grid at Halloran V.

At Terra the stakes rose even higher. Other Protectorate SDS systems were primarily monitor-class orbital defense systems supported by ground-based *Rattler* anti-aerospace mobile platforms and limited fixed capital weapon emplacements. Terra, however, combined a mobile *Caspar II* fleet, stationary *Caspar II* controlled monitor-class drones, and ground- and space-based naval weapons platforms. The discovery of the lightning-fast *Dragau Caspar II* interceptor finally explained the death of the Dragoons fleet over Mars, while the horror of the Megiddo SDS system was only balanced by its relative unreliability. The Megiddo Final Solution was a multi-part “scorched earth” system that was never fully realized. Only the “Dragon’s Breath” portion of the Megiddo, a multi-launch capital missile system, ever saw use and was later

considered a failed experiment by military theorists. But even in failure it was responsible for the destruction of a *Leviathan*-class WarShip. Something that took a small fleet of Word ships to achieve at Dieron, a single converted ore-processing station achieved over Titan.

Only perseverance, coordination and a refusal to retreat allowed the Coalition forces to press all the way to Terra. But the cost in WarShips, DropShips and people will be felt for decades or even longer.

## NEW UNITS

The following new units comprise part of the Word of Blake’s SDS system.

### NAGA CASPAR II CONTROL SHIP

The Word’s *Caspar II* system was originally thought to be an exact duplicate of the Star League-era *Caspar* system. Not until the final assault on Terra was it discovered that the *Caspar II*’s intelligence was human and not artificial, as originally believed. While capable of conducting fairly elaborate independent operations, the true strength of the *Caspar II* system was the ability for the drones to be directly controlled by a control ship. In the Terran system, a good portion of the *Caspar II* drones were controlled by three converted *Naga*-class WarShips, the *Divine Command*, *Celestial Threads* and *Enlightened Direction*. All three vessels had non-functional KF drives and were not deemed worth fully repairing. Instead, the ships were outfitted with the elaborate control systems required to be the first *Caspar II* control ships. The *Celestial Threads* was the first control ship brought online and controlled the *Dragau*-class *Caspar IIs* which defended Mars against the Dagoon assault. During Case WHITE, ComStar unknowingly dealt a near deadly blow to the Terran *Caspar II* network, putting both the *Threads* and the *Enlightened* out of action. However, by the time of the Coalition’s assault on Terra, the *Threads* had been repaired and additional smaller DropShips were converted to control smaller groups of *Caspar IIs*. These control ships and their drones accounted for a significant portion of the damage delivered to the Coalition forces during the final battles for Terra.

After the heavy damage received during Case WHITE, the two remaining *Naga* control ships were upgraded to improve their defenses. First, armor plates were layered on to protect key components of the ancient destroyers. Originally designed primarily for capital engagements, the *Naga* control ships lacked decent anti-fighter support. At the battle of Terra, they were equipped with matching batteries of VSP lasers and MML launchers in all arcs. Additional sub-capital weapons were added to improve anti-fighter and DropShip defense and an array of AMS and screen launchers was installed. These modifications were in addition to the existing *Caspar*



RULES ANNEX

II modifications. The fighter bays had been tripled in size and automated to carry *Hive*-class drone fighters. The Caspar II control system was able to operate thirty–six *Caspar II* drones at the same time. To support these drones, the *Nagas* had their cargo holds modified to include nine pressurized repair bays. This allowed them to carry and service six *Tiamat* and twelve *Dragau*-class *Caspar II* drones. Finally, crew space was significantly expanded to accommodate *Caspar II* operators and maintenance staff to maintain the drones.

Even after the *Divine Command*, the last operating control ship in Terran orbit, was destroyed, the *Caspar II* drones continued to haunt the invasion as their controlled drones shifted to their independent command trees and harried Coalition assets.

**Naga (Caspar II Control Ship)**

- Tech:** Inner Sphere
- Introduced:** 3065
- Mass:** 540,000 tons
- Length:** 540 meters
- Sail Diameter:** 1200 meters
- Fuel:** 2000 (5000)
- Tons/Burn Days:** 39.52
- Safe Thrust:** 2
- Maximum Thrust:** 3
- Sail Integrity:** 4
- KF Drive Integrity:** 0
- Heat Sinks:** 1300
- Structural Integrity:** 68
- Battle Value:** 35,397

**Armor**

- Nose:** 28
- Fore-Sides:** 32
- Aft-Sides:** 32
- Aft:** 28

**Cargo**

- Bay 1: 36 Fighter Cubicles (ARTS)      3 Doors
- Bay 2: 6 Small Craft Cubicles      1 Door
- Bay 3: 3 Standard Pressurized Repair Bays      3 Doors  
(75,000 ton capacity, each)
- Bay 4: 6 Standard Pressurized Repair Bays      6 Doors  
(7,500 ton capacity, each)
- Bay 5: Cargo (80,817 tons)      1 Door

- DropShip Capacity:** 0
- Grav Decks:** 1 (55m)
- Escape Pods:** 10
- Life Boats:** 22

**Crew:** 51 officers, 250 crew, 55 gunners, 114 bay personnel, 36 battle armor

**Ammunition:** 205 rounds of Capital AC ammunition (41 tons), 40 White Shark Missiles (1600 tons), 10 Barracuda Missiles (900 tons), 1664/1408 rounds of MML Missiles (128 tons), 40 Screen Canisters (400 tons), 264 rounds of Anti Missile System ammunition (22 tons)

**Notes:** Equipped with 355 tons of Standard Armor, Mobile HPG (50 tons), DTACS Control System (up to 36 *Caspar II* drones), and Naval Comm-Scanner Suite (Large)

**Weapons:**

Arc (Heat) Type	Capital Attack Values (Standard)				Class
	Short	Medium	Long	Extreme	
<b>Nose (242 Heat)</b>					
3 NAC/10 (45 rounds)	30	30	30	—	Capital AC
3 Sub-Capital Laser/1	3	3	3	—	Capital Laser
4 Large VSP Lasers	4 (40)	3 (28)	—	—	Pulse Laser
4 MML 9+Artemis (208/176 rounds)	6 (56)	3 (28)	3 (28)	—	MML
2 AMS (72 rounds)	1 (12)†	—	—	—	Point Defense
Screen Launcher (40 screens)	—	—	—	—	Screen
<b>FL/FR (219 Heat)</b>					
2 NAC/10 (40 rounds)	20	20	20	—	Capital AC
3 Sub-Capital Laser/2	6	6	6	—	Capital Laser



## RULES ANNEX

### Weapons:

#### Arc (Heat) Type

White Shark (20 missiles) 3 3 3 3 Capital Missile  
 4 Large VSP Lasers 4 (40) 3 (28) — — Pulse Laser

4 MML 9+Artemis (208/176 rounds) 6 (56) 3 (28) 3 (28) — MML

#### LBS/RBS (678 Heat)

2 NAC/10 (40 rounds) 20 20 20 — Capital AC

3 NL35 11 11 11 — Capital Laser

2 Light N-PPC 14 14 14 — Capital PPC

6 Sub-Capital Laser/3 18 18 18 — Capital Laser

4 Large VSP Lasers 4 (40) 3 (28) — — Pulse Laser

4 MML 9+Artemis (208/176 rounds) 6 (56) 3 (28) 3 (28) — MML

2 AMS (72 rounds) 1 (6)† — — Point Defense

Screen Launcher (10 Screens) — — — — Screen

#### AL/AR (510 Heat)

3 NL35 11 11 11 — Capital Laser

2 Light N-PPC 14 14 14 — Capital PPC

4 Large VSP Lasers 4 (40) 3 (28) — — Pulse Laser

4 MML 9+Artemis (208/176 rounds) 6 (56) 3 (28) 3 (28) — MML

2 Sub-Capital Laser/2 4 4 4 — Capital Laser

#### Aft (214 Heat)

1 Barracuda (10 Missiles) 2 2 2 2 Capital Missile

6 Sub-Capital Laser/1 6 6 6 — Capital Laser

4 Large VSP Lasers 4 (40) 3 (28) — — Pulse Laser

4 MML 9+Artemis (208/176 rounds) 6 (56) 3 (28) 3 (28) — MML

2 AMS (72 rounds) 1 (6)† — — Point Defense

Screen Launcher (20 Screens) — — — — Screen

significant threat to even the heaviest armored WarShip. During the final battle of Terra, a wounded *Dragau* was responsible for destroying the FSS *Excalibur*.

The *Dragau's* chief notoriety, however, is the destruction of the Wolf's Dragoon Mars task force. In their first live fire mission, the *Dragau* proved not only their effectiveness but that of the Caspar II system as a whole. Operators were able to safely control the attack craft from Mars' surface. Combined with the first generation *Hive*-class fighters, the destruction of the Dragoon fleet was accomplished with almost no Word of Blake pilots in active combat. Capable of destroying themselves to accomplish their mission, the *Dragau* was a repeated threat throughout Operation SCOUR.

**Type:** Military Aerodyne

**Use:** Interceptor

**Tech:** Inner Sphere

**Introduced:** 3065

**Mass:** 2500

**Battle Value:** 14,358

### Dimensions

**Length:** 90 meters

**Width:** 70 meters

**Height:** 20 meters

**Fuel:** 174 tons (6960 points)

**Tons/Burn-day:** 1.84

**Safe Thrust:** 9

**Maximum Thrust:** 14

**Heat Sinks:** 120 [240]

**Structural Integrity:** 15

### DRAGAU ASSAULT INTERCEPTOR CASPAR II DRONE

The *Dragau* was the test-bed platform for the Caspar II drone system. With no crew requirement to constrain their performance, it made sense to build *Caspar II* drones that took every advantage of this. Using a *Gazelle* hull for the prototype allowed the base craft to be quickly defined. More than half the hull is taken up by the massive engine system, which allows the *Dragau* to push an astonishing seven gravities of thrust. Combined with the fighter-like appearance and the additional ECM interference inherent in the Caspar II system, more than one ship commander mistook a *Dragau* for a heavy fighter.

The *Dragau's* massive engine severely limited the weapons it could carry, leaving it one of the few modern Word designs to not carry capital-grade weapons. While this greatly limited its firepower, its speed allowed the *Dragau* to make high-speed attack runs that allowed it to bring its still-impressive firepower to bear at close range. The six nose-mounted heavy PPCs and dual Heavy Gauss Rifles gave the *Dragau* the power to easily wound any DropShip in a single pass. Mounting the thickest armor feasible, these drone ships were able to conduct repeated attack runs without fear of critical damage. By operating in coordinated packs, the *Dragau* was a

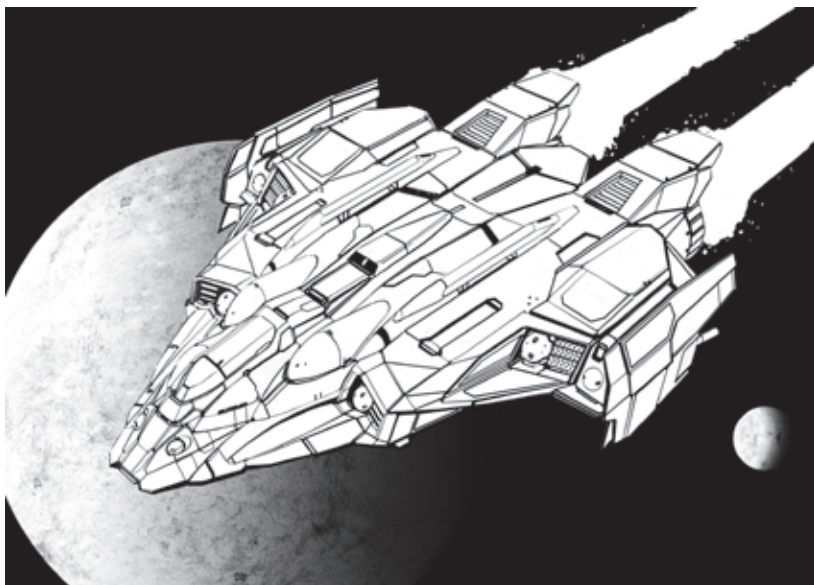

**RULES ANNEX**

**Armor**

**Nose:** 428  
**Sides:** 332  
**Aft:** 262

**Cargo**

None

**Life Boats:** 0

**Escape Pods:** 0  
**Crew:** None

**Ammunition:** 36 rounds Heavy Gauss ammunition (4 tons), 112 rounds of LRM-15 ammunition (14 tons), 144 rounds of Anti-Missile System ammunition (12 tons)

**Notes:** Equipped with 66 tons Heavy Ferro Aluminum armor, and a Caspar II Advanced Smart Robotic Control System (Gunnery 4, Piloting 5).

**Weapons:**

Arc (Heat) Type	Capital Attack Values (Standard)				Class
	Short	Medium	Long	Extreme	
<b>Nose (94 Heat)</b>					
2 Heavy Gauss Rifles (36 rounds)	5 (50)	4 (40)	4 (40)	—	Gauss
3 Heavy PPC	5 (45)	5 (45)	—	—	PPC
3 Heavy PPC	5 (45)	5 (45)	—	—	PPC
4 AMS (48 rounds)	1 (12)†	—	—	—	Point Defense
<b>LW/RW (60 Heat)</b>					
2 LRM 15+Artemis (56 rounds)	2 (24)	2 (24)	2 (24)	—	LRM
2 ERPPC	2 (20)	2 (20)	2 (20)	—	PPC
2 Large VSP Lasers	2 (20)	1 (14)	—	—	Pulse Laser
<b>LW/RW Aft (20 Heat)</b>					
2 Large VSP Lasers	2 (20)	1 (14)	—	—	Pulse Laser
<b>Aft (20 Heat)</b>					
2 Large VSP Lasers	2 (20)	1 (14)	—	—	Pulse Laser
3 AMS (72 rounds)	3 (9)†	—	—	—	Point Defense

**TIAMAT POCKET WARSHIP CASPAR II DRONE**

The *Tiamat* is a testament to how much power the Master granted Apollyon and the Manei Domini. Recognizing that even their extensive WarShip resources would be taxed by a war with the Clans, Apollyon ordered the creation of the *Tiamat* in 3066. It was to be the ultimate command and control vessel of the Manei Domini. Capable of destroying any three DropShips single handedly, its armor would allow it to go head-to-head with many of the smaller Star League-era WarShips in the Clan fleets. The dissolution of the Star League and complete shift in the Word's plans from destroying the Clans to punishing the Inner Sphere delayed development of the new vessel. The first crewed *Tiamat* would not see use until 3075. True to their design, they were provided only to the Shadow Divisions, serving as command vessels for the transport assets dedicated to each division.

Being produced in more numbers than the Shadow Divisions could crew, Cameron St. Jamais demanded they be provided to

his forces for use in defending the ever-increasingly imperiled Protectorate. Under pressure from the Master to acquiesce, but unwilling to let the *Tiamat* be sullied by mere "Frails," Apollyon proposed converting the new ships into *Caspar II* Drones. Eager to add the firepower to his forces by any means, St Jamais agreed and the *Tiamat* became the largest unmanned drone since the original Star League M-5 *Caspars*.

The largest assault DropShip ever produced, redesigning it as a *Caspar II* made the ship even deadlier. Increasing the base thrust by twenty-five percent, the ship only surrendered a minor amount of firepower. Six nose-mounted class 3 Sub-Capital Lasers and three heavy class sub-cap cannons form its primary armament. Six more fore-mounted sub-capital lasers allow it to bring significant firepower to any foe before it. Optimized for the slashing attacks *Caspar II* drones are best at, the rear armament is focused primarily on defending against aerospace fighter attacks. The six automated robotic transport bays typically house six *Aeshna* heavy drone fighters. With armor twice that of WarShips four times its size, the *Tiamat* represented a major threat throughout Operation SCOUR.

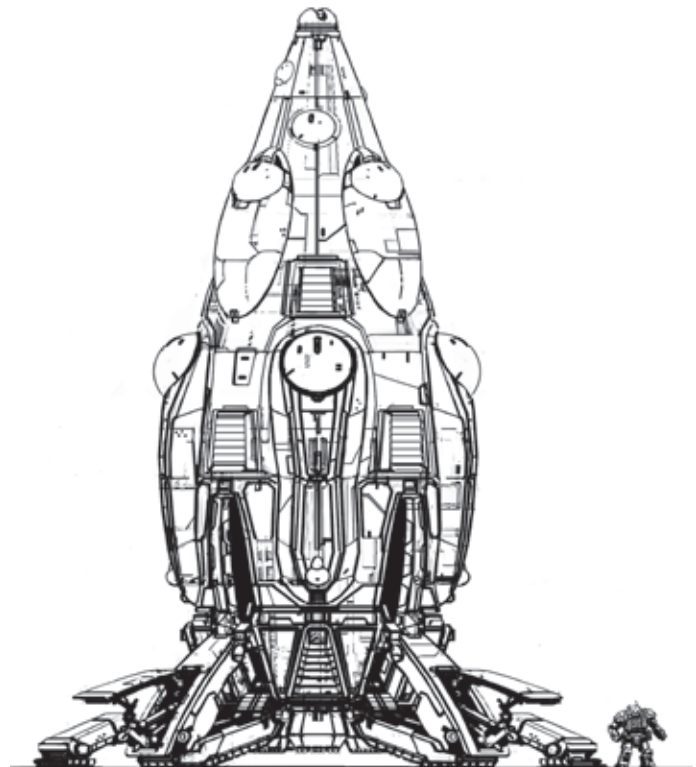

## RULES ANNEX

### Tiamat Class DropShip (drone)

**Type:** Military Spheroid

**Use:** Interceptor

**Tech:** Inner Sphere

**Introduced:** 3079

**Mass:** 36,000

**Battle Value:** 47,813

#### Dimensions

**Length:** 170 meters

**Width:** 90 meters

**Fuel:** 500 tons (10,000 points)

**Tons/Burn-day:** 1.84

**Safe Thrust:** 5

**Maximum Thrust:** 8

**Heat Sinks:** 415 [830]

**Structural Integrity:** 75

#### Armor

**Nose:** 810

**Sides:** 750

**Aft:** 705

#### Cargo

Bay 1: 6 Fighter Cubicles (ARTS)      6 Doors

Bay 2: Cargo (143 tons)      1 Doors

**Life Boats:** 0

**Escape Pods:** 0

**Crew:** None

**Ammunition:** 60 rounds Heavy Sub Capital Cannon ammunition (60 tons), 30 Piranha Missiles (300 tons), 80 Heavy Gauss ammunition.

**Notes:** Equipped with 219 tons Heavy Ferro Aluminum armor, and a Caspar II Advanced Smart Robotic Control System (Gunnery 4, Piloting 5)

#### Weapons:

**Arc (Heat) Type**

**Nose (446 Heat)**

6 Sub-Capital Laser/3      18      18      —      —      Capital Laser

3 Heavy Sub-Capital Cannon (60 rounds)      21      21      —      —      Capital AC

4 Heavy Gauss Rifle (80 rounds)      10 (100)      8 (80)      4 (40)      —      Gauss

4 ER PPC      4 (40)      4 (40)      4 (40)      —      PPC

4 Laser AMS      1 (12)†      —      —      —      Point Defense

**FL/FR (246 Heat)**

3 Sub-Capital Laser/3      9      9      —      —      Capital Laser

6 Heavy PPC      9 (90)      9 (90)      9 (90)      —      PPC

4 Laser AMS      1 (12)†      —      —      —      Point Defense

#### Capital Attack Values (Standard)

**Short    Medium    Long    Extreme    Class**

#### AL/AR (69 Heat)

1 Piranha Missile (15 Missiles)      3      3      3      —      Capital Missile

6 Large VSP Lasers      6 (60)      4 (42)      —      —      Pulse Laser

4 Laser AMS      1 (12)†      —      —      —      Point Defense

#### Aft (60 Heat)

6 Large VSP Lasers      6 (60)      4 (42)      —      —      Pulse Laser

4 Laser AMS      1 (12)†      —      —      —      Point Defense

Screen Launcher (20 Screens)      —      —      —      —      Screen

### DRAKE SDS CONTROL STATION

The *Drake* is a modified orbital monitoring and traffic control station similar to those seen above many industrialized worlds of the Inner Sphere. Built on the Terran Hegemony *Gatekeeper* traffic control stations, it is equipped with a Naval Comm-Scanner Suite that allows it to monitor, control, and direct communication over several AU of space. The *Gatekeeper* served as traffic control over all major Hegemony worlds and many can still be found in operation, permanent fixtures in their home systems and practically ignored.

When Precentor Martial St. Jamais began his Maginot Line project, he immediately identified the need to prevent hostile forces from ever landing on these worlds. Leveraging the proven Caspar II technologies, St. Jamais created an orbital defense grid that would require minimal manpower while offering the ability to stop hostile landings on the Maginot worlds. The *t* Monitor Platform was the final solution for this defense grid, but required the use of control ships. The Word reopened the Titan yard section that built *Gatekeepers* and modified them to manufacture the *Drake* SDS Station. Reinforced with stronger armor and upgraded defensive weapons, including a Stingray sub-capital missile system, the *Drake* was able to hold up to any casual attack directed at it while maneuvering its slaved *Cockatrice Caspar II* drones to attack any hostile threat. The extensive communications system also allowed the *Drake* to connect and even control—albeit limitedly—swarms of drone fighters.

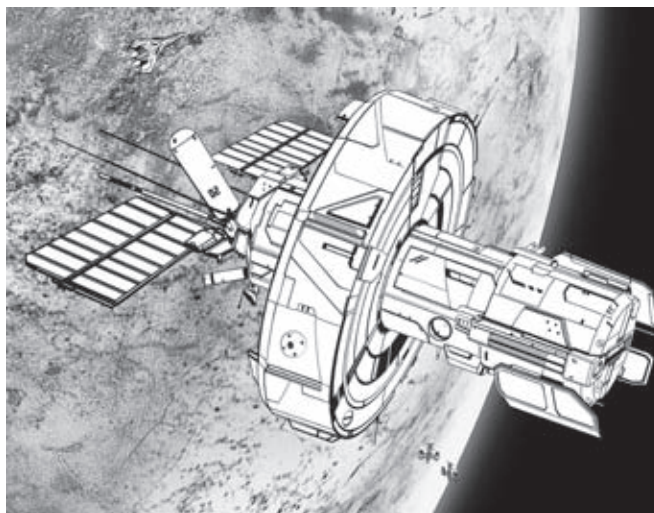





**RULES ANNEX**

The integral Direct Tactical Analysis Control System allows the *Drake* to control up to eighteen *Caspar II* drones. With an ability to call on fire from its *Caspar IIs*, drone fighters, and support from ground-based SDS platforms, the *Drake* was a formidable command and control system that became a high priority for elimination by Coalition forces.

**Drake SDS Control Station**

**Type:** Space Station  
**Tech:** Inner Sphere  
**Introduced:** 3071  
**Mass:** 12,000 tons

**Dimensions:**

**Length:** 250 meters  
**Width:** 80 meters

**Fuel:** 500 (5,000)  
**Tons/Burn Days:** 2.82  
**Heat Sinks:** 120 (240)  
**Structural Integrity:** 1  
**Battle Value:** 3,533

**Armor**

**Nose:** 18  
**Fore-Sides:** 18  
**Aft-Sides:** 18  
**Aft:** 18

**Cargo**

Bay 1: Unpressurized Repair Bay (5,000 ton capacity) 1 Door  
 Bay 2: 4 Small Craft Cubicle 2 Doors  
 Bay 3: Cargo (3,820.5 tons) 2 Doors

**DropShip Capacity:** 0  
**Grav Decks:** 1 (600m)  
**Escape Pods:** 0  
**Life Boats:** 15

**Crew:** 14 officers, 67 crew, 15 gunners, 22 bay personnel, 12 battle armor

**Ammunition:** 20 Swordfish Missiles (300 tons), 624/528 rounds of MML Missiles (48 tons), 40 Screen Canisters (400 tons), 96 rounds of Anti Missile System ammunition (8 tons)

**Notes:** Equipped with 34.5 tons of Lamellor Ferro-Carbide, DTACS (up to 18 *Caspar II* drones), and Naval Comm-Scanner Suite (Large)

**Weapons:**

**Arc (Heat) Type Nose (73 Heat)**

Swordfish (20 missiles) 4  
 2 ER Large Lasers 2 (16)  
 2 MML 9+Artemis (78/66 rounds) 3 (28)  
 6 Medium Pulse Lasers 4 (36)  
 2 AMS (48) 1 (6)†  
 Screen Launcher (20 Screens) —

**FL/FR (58 Heat)**

2 ER Large Lasers 2(18)  
 2 MML 9+Artemis (78/66 rounds) 3 (28)  
 6 Medium Pulse Lasers 4 (36)

**AL/AR (58 Heat)**

2 ER Large Lasers 2(18)  
 2 MML 9+Artemis (78/66 rounds) 3 (28)  
 6 Medium Pulse Lasers 4 (36)  
 Screen Launcher (10 Screens) —

**Aft (58 Heat)**

2 ER Large Lasers 2(18)  
 2 MML 9+Artemis (78/66 rounds) 3 (28)  
 6 Medium Pulse Lasers 4 (36)  
 2 AMS (48 rounds) 1 (6)†

**Capital Attack Values (Standard)**

	Short	Medium	Long	Extreme	Class
Swordfish (20 missiles)	4	—	—	—	Capital Missile
2 ER Large Lasers	2 (16)	2 (16)	2 (16)	—	Laser
2 MML 9+Artemis (78/66 rounds)	3 (28)	1 (14)	1 (14)	—	MML
6 Medium Pulse Lasers	4 (36)	—	—	—	Pulse Laser
2 AMS (48)	1 (6)†	—	—	—	Point Defense
Screen Launcher (20 Screens)	—	—	—	—	Screen
<b>FL/FR (58 Heat)</b>					
2 ER Large Lasers	2(18)	2(18)	2(18)	—	Laser
2 MML 9+Artemis (78/66 rounds)	3 (28)	1 (14)	1 (14)	—	MML
6 Medium Pulse Lasers	4 (36)	—	—	—	Pulse Laser
<b>AL/AR (58 Heat)</b>					
2 ER Large Lasers	2(18)	2(18)	2(18)	—	Laser
2 MML 9+Artemis (78/66 rounds)	3 (28)	1 (14)	1 (14)	—	MML
6 Medium Pulse Lasers	4 (36)	—	—	—	Pulse Laser
Screen Launcher (10 Screens)	—	—	—	—	Screen
<b>Aft (58 Heat)</b>					
2 ER Large Lasers	2(18)	2(18)	2(18)	—	Laser
2 MML 9+Artemis (78/66 rounds)	3 (28)	1 (14)	1 (14)	—	MML
6 Medium Pulse Lasers	4 (36)	—	—	—	Pulse Laser
2 AMS (48 rounds)	1 (6)†	—	—	—	Point Defense

**COCKATRICE MONITOR PLATFORM DRONE**

The Word's early experiments in SDS satellites revealed why the Star League rarely used such technology in their defense networks. Fragile, unable to maneuver on their own, and unable to mount any appreciable armaments, the Star League relegated satellites to primarily surveillance roles. Those few offensive

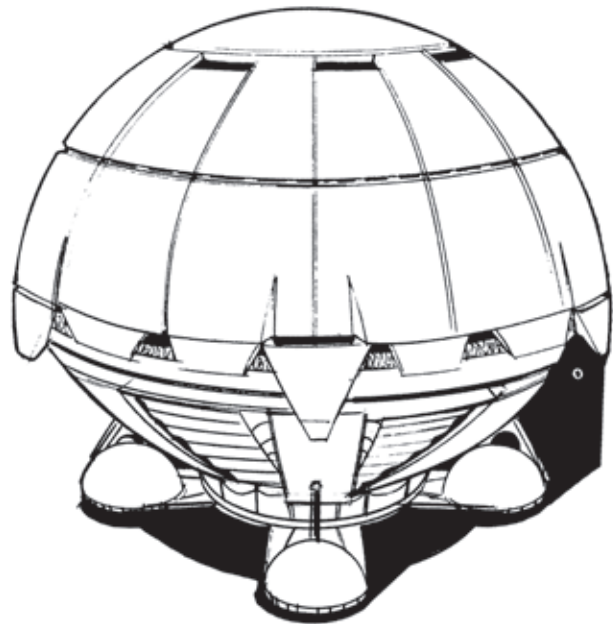

## RULES ANNEX



systems to see actual use were highly limited in capability. The single-use deployment vehicles, used for deploying the *BlackWasp* drone fighter and *Pulsar* anti-missile satellites, are some of the few satellite systems to ever see wide spread usage.

Despite these limitations, Cameron St. Jamais knew he needed an unmanned solution to deploy across his Maginot Line. A platform that could monitor, respond, and defeat a hostile attack force while still in orbit, the *Cockatrice* Monitor Platform best fit the requirements needed. Using the K-1 DropShuttle as its design base, Word engineers expanded the hull while leaving the original engine in place. At 800 tons, the new DropShip was barely capable of a single gravity of thrust. The first in what the Word envisioned as a line of *Monitor*-class defense stations, they were outfitted with Caspar II drone systems and linked into networks controlled by a *Drake* SDS Station. The *Cockatrice* is layered with nearly as much armor as the hull can tolerate, allowing it to shrug off attacks from fighters and most DropShips. The main offensive armament is a Piranha sub-capital missile launcher and is backed up by a large array of conventional weapons. Individually unimpressive, when linked into network of a dozen or more and utilizing a central command and control, the *Cockatrice* became a deadly threat.

The *Cockatrice*-class Monitor Platform, operating in the dozens and backed by their *Drake* control stations, were responsible for the destruction of the *Franco Martell* over Halloran V. When the massive WarShip dropped into low orbit in preparation for an orbital bombardment, the SDS system activated. Surrounded on all sides by the tiny craft, the *Martell* was able to destroy a large number of the Monitor ships, but the unending pin pricks of dozens of sub-capital missiles finally took a toll. By the time ground-based platforms added heavier fire, the *Martell* was already critically wounded and quickly broke apart.

**Cockatrice (Drone) Monitor Platform****Type:** Military Spheroid**Use:** Monitor**Tech:** Inner Sphere**Introduced:** 3062**Mass:** 800 tons**Battle Value:** 4,428**Dimensions****Length:** 35 meters**Width:** 35 meters**Fuel:** 10 tons (600 points)**Tons/Burn-day:** 1.84**Safe Thrust:** 1**Maximum Thrust:** 2**Heat Sinks:** 68 [136]**Structural Integrity:** 15**Armor****Nose:** 221**Sides:** 221**Aft:** 210**Cargo**

None

**Life Boats:** 0**Escape Pods:** 0**Crew:** None**Ammunition:** 15 Piranha Missiles (200 tons), 96 rounds Light Gauss ammunition (6 tons), 36 rounds LRM ammunition (6 tons)**Notes:** Equipped with 41 tons Heavy Ferro Aluminum armor, and an improved Caspar II Advanced Smart Robotic Control System (Gunnery 3, Piloting 4)

Weapons: Arc (Heat) Type Nose (42 Heat)	Capital Attack Values (Standard)				Class
	Short	Medium	Long	Extreme	
1 Piranha Missile (15 Missiles)	3	3	3	—	Capital Missile
2 Large Pulse Laser	2 (18)	2 (18)	—	—	Pulse Laser
2 LRM 20+Artemis (36 rounds)	3 (32)	3 (32)	3 (32)	—	LRM
1 Light Gauss Rifle Ammo (LGR) 32	1 (8)	1 (8)	1 (8)	1 (8)	Gauss
1 Laser AMS	0 (3)†	—	—	—	Point Defense
<b>FL/FR (21 Heat)</b>					
2 Large Pulse Laser	2 (18)	2 (18)	—	—	Pulse Laser
1 Light Gauss Rifle Ammo (LGR) 32	1 (8)	1 (8)	1 (8)	1 (8)	Gauss
1 Laser AMS	0 (3)†	—	—	—	Point Defense
<b>AL/AR (20 Heat)</b>					
2 Large Pulse Laser	2 (18)	2 (18)	—	—	Pulse Laser
1 Laser AMS	0 (3)†	—	—	—	Point Defense
<b>Aft (32 Heat)</b>					
2 Large Pulse Laser	2 (18)	2 (18)	—	—	Pulse Laser
1 ER Large Laser	1 (8)	1 (8)	1 (8)	—	Laser

**HIVE-CLASS DRONE FIGHTERS**

While much of the Star League's best technology was lost with Kerensky's Exodus and the subsequent Succession Wars, ComStar managed to retain many of the Terran Hegemony's best technological secrets. Smart Robotic Systems, like those used on the Star League-era *BlackWasp* and *VoidSeeker*, was a technology never lost to the secretive order. These secrets allowed the Word of Blake to begin design on the *Hive*-class fighters before they had retaken Terra. Once in control of Terra's manufacturing might, *Hive* fighters would move from design to reality.

Having experimented with ancient models of the *BlackWasps* and modern experimental *Tridents*, Blakist designers chose to create a new line of fighters optimized to be drone craft. A series

RULES ANNEX

of three drone fighters were built to work in self-supporting concert. Using a heavier improved Smart Robotic Control System, *Hive* fighters possessed superior combat abilities over earlier drone fighters.

The *Tabanid* is a fast interceptor designed for slashing attacks using its extended-range large laser. As it dives deep into enemy formations, its nose-mounted Beagle Active Probe pierces hostile ECM fields for its fellow drone fighters. Nine tons of ferro-fibrous armor provided the *Tabanid* with impressive protection.

The *Scarab* is the drone series' multi-role fighter-bomber. Able to carry seven standard or light air-to-air missiles, or two massive anti-ship-class missiles, the *Scarab* is a significant threat against space, air, and ground targets. Pulse lasers offset the limitations of the drone's battle computer, allowing it to engage effectively even with veteran pilots. The Guardian ECM system allows it to screen not only itself but provide cover for the slower *Aeshna* and retreating *Tabanids*.

The *Aeshna* heavy drone fighter carries armor on par with the heaviest armored fighters in production. The large VSP lasers give it accuracy in all engagements, while the ultra-class autocannons give a squadron of these fighters the ability to tear through a DropShip's armor in just a few salvos. The dual extended-range lasers in the nose seem almost an afterthought. With a heavy airframe, it could easily carry a heavy bomb load, but with an engine smaller than the *Scarab*, it typically only carries two anti-ship missiles.

First launched in 3058, the original incarnation of the three *Hive*-class fighters were designed along Star League-era lines. It was not until a refit program in the early 3070s that all three fighters were upgraded with heavy ferro-aluminum armor when

they took on their more *Spectral*-like appearance. This improved armor added even further durability to the already durable craft. During this refit, the *Scarab* and *Aeshna* also exchanged their lasers for advanced VSP lasers.

**Tabanid Light Drone Fighter**

**Type:** Tabanid  
**Technology Base:** Inner Sphere  
**Tonnage:** 35  
**Battle Value:** 956

Equipment		Mass
Engine:	280 XL	8
Safe Thrust:	10	
Maximum Thrust:	15	
Structural Integrity:	10	
Heat Sinks:	10 [20]	0
Fuel:	480	6
Cockpit:		3
Armor Factor (Heavy Ferro):	178	9
	<i>Armor Value</i>	
Nose	52	
Wings	42/42	
Aft	42	

Weapons and Ammo	Location	Tonnage	Heat	SRV	MRV	LRV	ERV
ER Large Laser	Nose	5	12	8	8	8	—
Beagle Active Probe	Nose	1.5	—	—	—	—	—
ASRCS (Improved)	—	2.5	—	—	—	—	—

**Note:** Aerospace Smart Robotic Control System (Improved) gives the *Tabanid* a Piloting Skill of 5 and a Gunnery Skill of 4

**Scarab Medium Drone Fighter**

**Type:** Scarab  
**Technology Base:** Inner Sphere  
**Tonnage:** 70  
**Battle Value:** 1,364

Equipment		Mass
Engine:	350 XL	15
Safe Thrust:	7	
Maximum Thrust:	11	
Structural Integrity:	7	
Heat Sinks:	17 [34]	7
Fuel:	480	6
Cockpit:		3
Armor Factor (Heavy Ferro):	208	10.5

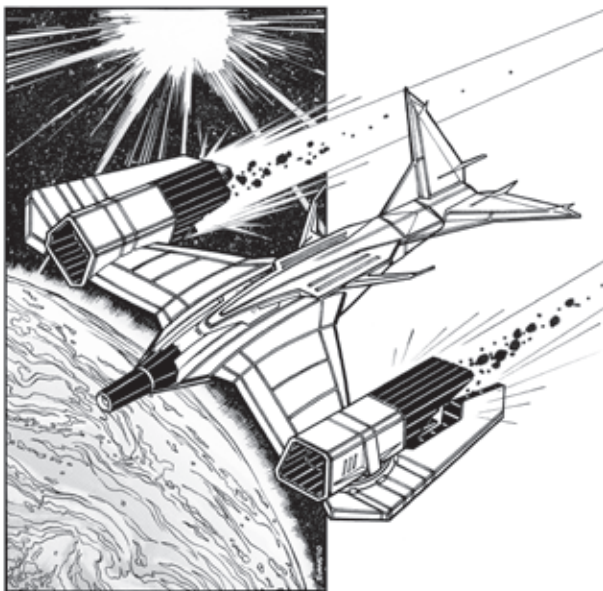

## RULES ANNEX

	<i>Armor Value</i>
Nose	62
Wings	52/52
Aft	42

Weapons and Ammo	Location	Tonnage	Heat	SRV	MRV	LRV	ERV
2 Medium VSP Lasers	Nose	8	14	7	—	—	—
Guardian ECM Suite	Nose	1.5	—	—	—	—	—
Large Pulse Laser	RW	7	10	9	9	—	—
Large Pulse Laser	LW	7	10	9	9	—	—
ASRCS (Improved)	—	5	—	—	—	—	—

**Note:** Aerospace Smart Robotic Control System (Improved) gives the *Scarab* a Piloting Skill of 5 and a Gunnery Skill of 4



Weapons and Ammo	Location	Tonnage	Heat	SRV	MRV	LRV	ERV
2 ER Medium Lasers	Nose	2	5	5	5	—	—
Ultra AC/10	RW	13	8	15	15	—	—
Ultra AC/10	LW	13	8	15	15	—	—
Ammo (Ultra 10)	—	4	—	—	—	—	—
Large VSP Laser	RW	9	10	10	7	—	—
Large VSP Laser	LW	9	10	10	7	—	—
ASRCS (Improved)	—	7	—	—	—	—	—

**Note:** Aerospace Smart Robotic Control System (Improved) gives the *Aeshna* a Piloting Skill of 5 and a Gunnery Skill of 4

### Aeshna Heavy Drone Fighter

**Type:** Aeshna

**Technology Base:** Inner Sphere

**Tonnage:** 100

**Battle Value:** 2,032

Equipment		Mass
Engine:	300 XL	9.5
Safe Thrust:	5	
Maximum Thrust:	8	
Structural Integrity:	10	
Heat Sinks:	21 (42)	11
Fuel:	480	6
Cockpit:		3
Armor Factor (Heavy Ferro):	267	13.5
	<i>Armor Value</i>	
Nose	85	
Wings	64/64	
Aft	54	

### DRAGON'S BREATH MULTIPLE CAPITAL LAUNCH SYSTEM

Officially the Megiddo System Space Platform (SSP), Word technicians servicing these stations coined the term "Dragon's Breath" in an obvious nod to the Caspar II draconian naming scheme and their devastating effect on a potential target. Like much of the Megiddo system, it was disguised within seemingly innocuous civilian structures. In the Breath's case, the system took the Word's Q-Ship concept to the next level by outfitting small civilian grade space stations with an experimental Multiple Capital Missile Launch System. The stations were then fitted with Aerospace Smart Robotic Control Systems and programmed for very specific targets or conditions.

Built as the ultimate "smart" space mine, the system's concept scales up a one-shot missile system to capital scale. It was capable of launching ten Killer Whales in a single salvo. Four of the missiles were outfitted with special ECM systems designed to fool a target's point defense system, resulting in a waste of the target's anti-missile fire on empty space.

**RULES ANNEX**

The remaining missiles launched in a ripple pattern of two, three, and one. The first two waves were designed to blast away the armor of the target, allowing the final missile to pass unimpeded into the heart of the vessel. In the case of the Ghost Bear's *Leviathan*-class *Great Bear*, this system worked flawlessly in the failed defense of the Titan Yards. Believing they were being attacked by over thirty Peacemakers, the *Bear's* point defenses were still firing at ghost targets when the final missile exploded deep within its superstructure.

Fortunately the system was far from perfect; of the other ten Dragon's Breath platforms in the Terran system, none managed to do any significant damage to Coalition forces.

An early prototype of the system was present in the Towne system. Equipped with non-nuclear warheads, it only activated when remote sensors detected the passage of the Federated Suns WarShip *Indefatigable*. Launched on a ballistic trajectory, the missiles went active only as they closed on the *Indefatigable's* flight path. Severely damaging the WarShip, the attack proved the concept for the final system activated at Terra. Fortunately for the Coalition, this early prototype was unusually successful and not an indication of the Megiddo's true capability.

**Ore Processing Facility: Dragon's Breath Multiple Capital Launch System**

**Type:** Space Station  
**Tech:** Inner Sphere  
**Introduced:** 2435  
**Mass:** 5000 tons

**Dimensions:**  
**Length:** 120 meters  
**Width:** 40 meters  
**Fuel:** 500 (5000)  
**Tons/Burn Days:** 2.82  
**Heat Sinks:** 20  
**Structural Integrity:** 1  
**Battle Value:** 250

**Armor**  
**Nose:** 2  
**Fore-Sides:** 2  
**Aft-Sides:** 2  
**Aft:** 2

**Cargo**

Bay 1: Unpressurized Repair Bay (10,000 ton capacity)	1 Door
Bay 2: 2 Small Craft Cubicle	1 Door
Bay 3: Ore Processing Facility	0 Doors
Bay 4: Cargo (1,350 tons)	2 Doors

**DropShip Capacity:** 0  
**Grav Decks:** 1 (100m)  
**Escape Pods:** 0  
**Life Boats:** 15

**Crew:** 6 officers, 40 crew, 2 gunners, 10 bay personnel, 100 ore processing staff (Dragon's Breath: None)

**Ammunition:** None

**Notes:** Equipped with 15 tons of Standard Armor. (Unpressurized bay is permanently fitted with a Dragon's Breath Multiple Capital Launch system mounted in the nose firing arc. Equipped with an Aerospace Smart Robotic Control System. Dragon's Breath system has no BV assigned to it. It should only be used in play with the agreement of all players.)

Weapons: Arc (Heat) Type	Capital Attack Values (Standard)				Class
	Short	Medium	Long	Extreme	
<b>Nose (6 Heat)</b> 2 Small Lasers	1 (6)	—	—	—	Laser
<b>FL/FR (6Heat)</b> 2 Small Lasers	1 (6)	—	—	—	Laser
<b>AL/AR (6Heat)</b> 2 Small Lasers	1 (6)	—	—	—	Laser
<b>Aft (6 Heat)</b> 2 Small Lasers	1 (6)	—	—	—	Laser

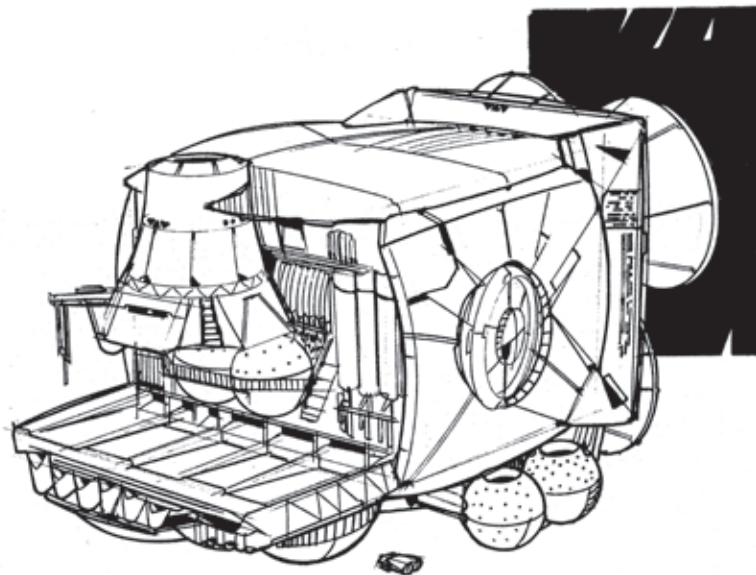

## RULES ANNEX

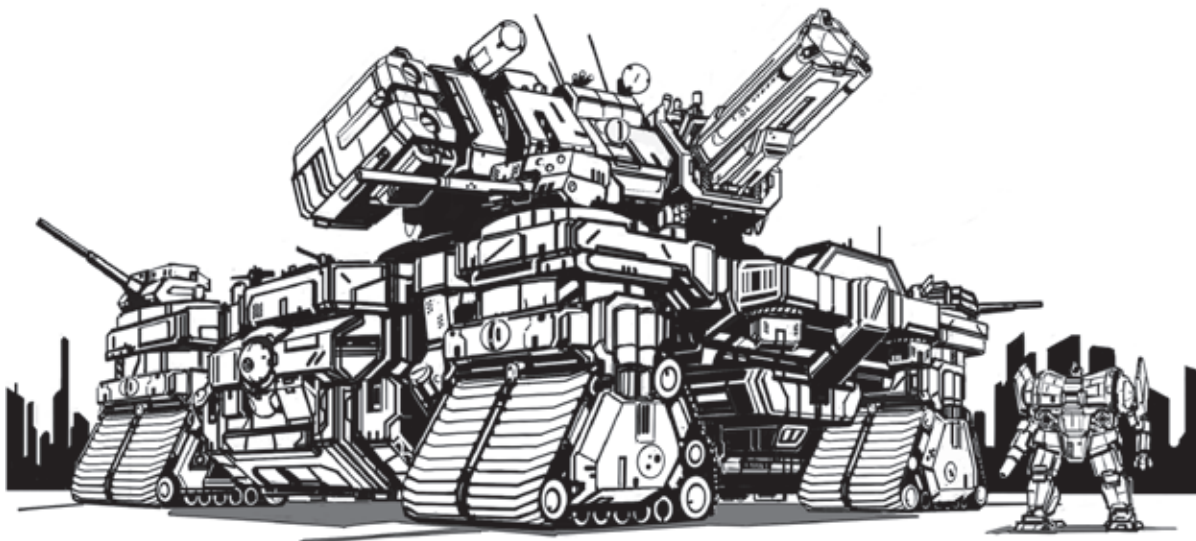

### RATTLER MK II ANTI-AEROSPACE MOBILE FORTRESS

The original Rattler Mobile Fortress was built at the same time as Jonathan Cameron's more famous Caspar SDS project. Where the M-5 drones would patrol space, the Rattler was designed to add flexibility to Castles Brian defenses. Less than a half-dozen Rattlers would survive the original liberation of Terra to be mothballed by the then-forming ComStar order. When the Word of Blake captured Terra in 3058, they quickly reactivated these platforms and began construction of additional platforms.

The Rattler stands over 40 meters tall, with motive treads that stand as high as an *Atlas*. The ninety meter radial platform is heavily armored and bristling with firepower. The original Star League Mk I models were equipped with five Barracuda launchers capable of targeting enemy vessels from orbit to low altitude. The Word's Mk II upgrades would remove three launchers and a significant volume of cargo space to mount the heaviest class of sub-capital lasers. Sacrificing range for firepower and a lack of ammo dependence meant the Mk II was less capable of striking orbital targets but made it deadly for any airborne object trying to close with it. Defensive turrets were equipped with Long Tom and Arrow IV artillery systems and short range defensive weapons. Hull-mounted weapons bristled from all sides, making a direct attack on the Rattler costly to any hostile force. On the Mk II, the Word replaced the heavy autocannons with heavy Gauss rifles, but otherwise left the conventional weapons unchanged. Two battalions of jump infantry and four attack VTOLs provide additional protection for the lumbering mobile structures. The Rattler's greatest strength is the storage modifications made to the Terran Castles Brian, allowing the gigantic structures to

shelter underground until needed. When the Word upgraded the Devils Tower facility to a full Brian structure, they included four Rattler Mk IIs and sally ports large enough for them to enter and exit the underground facility.

#### Rattler MK II Anti-Aerospace Mobile Fortress

**Type:** Rattler Mk II (Mobile Structure)

**Chassis Type:** Fortress

**Motive Type:** Ground

**Technology Base:** Inner Sphere

**Introduced:** 3072

**Mass:** 4,667.5 tons

**Structure:** Hardened

**Size:** 7 Hexes

**Battle Value:** 14,495

#### Dimensions

**Length:** 90 meters (3 Hexes)

**Width:** 90 meters (3 Hexes)

**Height:** 42 meters (5 Levels, plus 2 Levels Motive Systems)

**Power System:** Fusion

**Fuel:** N/A

**Maximum MP:** 2

**Heat Sinks:** 176 (32 Hex 1, 20 Hex 2, 32 Hex 3, 20 Hex 4, 2 Hex 5, 32 Hex 6, 20 Hex 7)

**Construction Factor:** 150

**Armor:** 150 (per hex)



**RULES ANNEX**

**Cargo:** 636 tons (25t Hex 1, 180t Hex 2, 89t Hex 3, 22t Hex 4, 22t Hex 5, 15t Hex 6, 283t Hex 7)

**Doors:** 1 Hex 1, 2 Hex 4, 2 Hex 5, 1 Hex 6

**Light Vehicle Bays:** 4 (2 Hex 2, 2 Hex 6)

**Jump Infantry Bays:** 6 (3 Hex 2, 3 Hex 7)

**Escape Pods:** 0

**Crew:** 43 officers, 42 crew, 105 gunners, 177 bay personnel

**Notes:** 24 crew quarters (6 Hex 2, 12 Hex 3, 6 Hex 7) used for double occupancy officers, 98 steerage quarters (12 Hex 1, 22 Hex 2, 25 Hex 3, 14 Hex 6, 25 Hex 7) used for triple occupancy crew, 1 MASH unit with 2 additional theatres (Hex 3), 10 tons communications equipment (Hex 3), 2 field kitchens (Hex 3), 4 lift hoists (2 Hex 2, 2 Hex 7), 4 arresting hooks (2 Hex 1, 2 Hex 6).

**Hexes 1, 6:**

**Weapons and Equipment**

**Hex/Location**

- 1 Sub-Capital Laser/3 Level 5
- 2 Light Machine Guns Level 2
- Ammo (Light MG) 400 Level 2
- 2 Streak SRM 6 Level 2
- Ammo (Streak) 45 Level 2
- 2 LRM 20+Artemis Level 2
- 1 Heavy Gauss Rifle Level 2
- Ammo (Heavy Gauss) 96 Level 2
- 2 Anti-Missile Systems Level 2
- Ammo (AMS) 48 Level 2

**Hexes 2, 7:**

**Weapons and Equipment**

**Hex/Location**

- 1 Long Tom Turret
- Ammo (Long Tom) 200 Level 2
- 1 Arrow IV Missile Turret
- Ammo (Arrow IV) 60 Level 2
- 2 Streak SRM 6 Turret
- Ammo (Streak) 45 Level 2
- 4 Machine Guns Level 2
- Ammo (Light MG) 400 Level 2
- 2 Large Pulse Lasers Level 2
- 2 Anti-Missile Systems Level 2
- Ammo (AMS) 48 Level 2

**Hex 3:**

**Weapons and Equipment**

**Hex/Location**

- 1 Sub-Capital Laser/3 Level 5

**Hexes 3, 4, 5:**

**Weapons and Equipment**

**Hex/Location**

- 1 Barracuda (15 Missiles) Level 5

- 2 Streak SRM 6 Level 2
- Ammo (Streak) 45 Level 2
- 4 Machine Guns Level 2
- Ammo (Light MG) 400 Level 2
- 2 Large Pulse Lasers Level 2
- 2 Anti-Missile Systems Level 2
- Ammo (AMS) 48 Level 2

**WYRM SDS SUBMERSIBLE FORTRESS**

The Wyrms Mobile Fortresses were the first in what the Word saw as a series of specialized SDS platforms. Well aware that ComStar knew all of Terra's ground-based SDS locations, the Word mounted several projects to strengthen their Star League-era defenses. Reactivating the mothballed Rattlers was one step, but a far more ambitious project was the Wyrms SDS project.

Begun just weeks after seizing control of Terra, the first Wyrms would not launch until 3072. One of the largest mobile structures ever constructed, the added complexity of making it fully submersible would make the vessels prohibitively expensive and immensely complicated to construct. As a result, and fortunately for the Coalition, only a dozen Wyrms were built before the invasion.

The firepower of just a single Wyrms was sufficient to vaporize an assault DropShip in a single salvo. Each vessel was equipped with four class 55 naval lasers, four Barracuda launchers, twin Killer Whale launchers and a single Tele-Operated Killer Whale launcher. As long as two football fields and nearly as wide, the pressurized hull was heavily armored and compartmentalized, allowing the vessel to sustain severe damage and continue to operate well after conventional submersibles would be destroyed. Four retractable turrets, each weighing over 100 tons, provided enough firepower to destroy aerospace fighters in a single salvo. The hulls bore numerous weapons blisters, equipped with energy weapons and both long and short range torpedo tubes, making a sub-surface attack highly risky. Two Moray heavy attack subs and two Manta fast-attack submersibles were carried onboard to add to its underwater defenses. On the rear of the Wyrms, behind the centrally-mounted conning tower, was a helipad which allowed it to receive supplies and reinforcements without ever entering port. Four on-board bays allowed for both support and combat VTOLs to be carried. Quarters for a Level II of battle armor provided intership defense and the onboard hospital, repair facilities, and extensive cargo spaces meant the Wyrms could remain at sea for months or even years at a time.

During the battle for Terra, five of the Wyrms were captured in fierce hand-to-hand boarding actions along the Asian continental coastline. Five more were destroyed by orbital counter-fire or targeted aerospace bombing runs. As of January, 3079, two of the vessels remain at large, keeping to the deepest parts of Terra's oceans except for brief surfacing to replenish their oxygen supplies or launch guerrilla attacks.

## RULES ANNEX

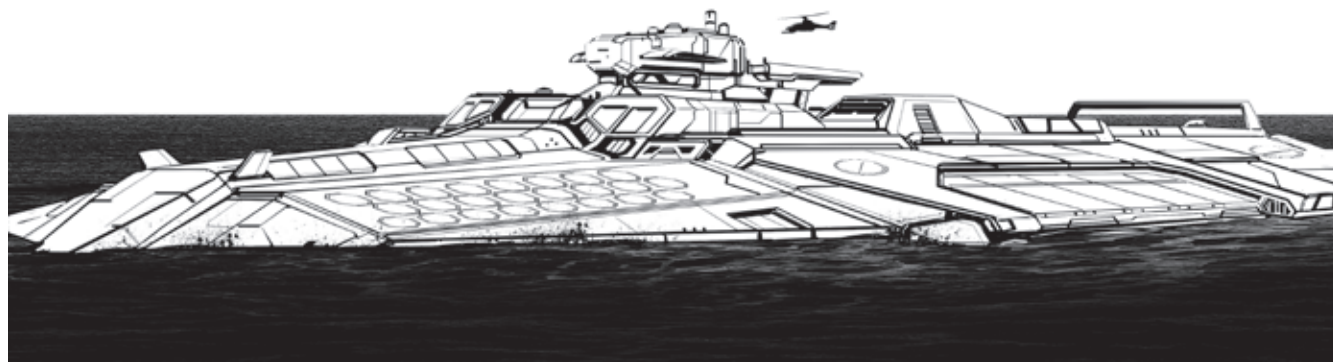

### Wyrms SDS Submersible Fortress

**Type:** Wyrms SDS Mobile Fortress (Mobile Structures)

**Chassis Type:** Fortress

**Motive Type:** Naval (Submersible)

**Technology Base:** Inner Sphere

**Introduced:** 3072

**Mass:** 22,726.5 tons

**Structure:** Hardened

**Size:** 20 Hexes

**Battle Value:** 47,107

#### Dimensions

**Length:** 180 meters (6 Hexes)

**Width:** 150 meters (5 Hexes)

**Height:** 60 meters (10 Levels)

**Power System:** Fusion

**Fuel:** N/A

**Maximum MP:** 4

**Heat Sinks:** 1,844 (100 Hex 1, 224 Hex 2, 85 Hex 3, 224 Hex 4, 85 Hex 6, 180 Hex 8, 180 Hex 12, 159 Hex 13, 159 Hex 15, 224 Hex 16, 224 Hex 18)

**Construction Factor:** 150

**Armor:** 150 (per hex)

**Cargo:** 4224.5 tons (231.5t Hex 1, 134.5t Hex 2, 72.5t Hex 3, 134.5t Hex 4, 269.5t Hex 5, 59t Hex 6, 269.5t Hex 7, 285.5t Hex 8, 2.5t Hex 9, 578.5t Hex 10, 2.5t Hex 11, 285.5t Hex 12, 32.5t Hex 13, 107.5t Hex 14, 32.5t Hex 15, 794.5t Hex 16, 137.5t Hex 17, 794.5t Hex 18)

**Doors:** 2 Hex 8, 1 Hex 9, 1 Hex 11, 2 Hex 12, 1 Hex 13, 1 Hex 14, 1 Hex 15, 1 Hex 16, 1 Hex 18

**Super-Heavy Vehicle Bays:** 4 (Bays (2 Hex 2, 2 Hex 4)

**Heavy Vehicle Bays:** 8 (4 Hex 2, 4 Hex 4)

**Light Vehicle Bays:** 4 Light Vehicle Bays (Hex 17)

**Escape Pods:** 40 (20 Hex 16, 20 Hex 18)

**Escape Pods (Maritime):** 30 (10 Hex 1, 10, Hex 8, 10 Hex 12)

**Crew:** 100 officers, 108 crew, 324 gunners, 243 bay personnel, 36 battle armor, 36 Marines

**Notes:** 36 steerage quarters (Hex 1), 356 crew quarters (80 Hex 1, 80 Hex 8, 80 Hex 10, 80 Hex 12, 36 Hex 17), 50 officer quarters (10 Hex 1, 10 Hex 8, 10 Hex 10, 20 Hex 12). All crew and officer quarters are double occupancy. 1 MASH unit with 10 additional theatres (Hex 6), 20 tons communications equipment (Hex 10), 3 field kitchens (Hex 10), 1 helipad (Hex 17), 2 mobile field bases (Hex 17), 4 lift hoists (Hex 17)

#### Hexes 1, 17:

##### Weapons and Equipment

4 LRT 20+Artemis  
 Ammo (LRT) 120  
 4 ER Large Lasers  
 4 SRT 6+Artemis  
 Ammo (SRT) 120  
 6 Medium Pulse Lasers  
 4 Laser Anti-Missile Systems

##### Hex/Location

Level 5  
 Level 5  
 Level 5  
 Level 5  
 Level 5  
 Level 5  
 Level 5





RULES ANNEX

**Hexes 2, 4, 16, 18:  
Weapons and Equipment**

	<b>Hex/Location</b>
2 Arrow IV Missile	Turret
Ammo (Arrow IV) 60	Level 5
2 Gauss Rifles	Turret
Ammo (Gauss) 80	Level 5
4 LB 2-X AC	Turret
Ammo (LB-X) 540	Level 5
4 LRM 20+Artemis	Turret
Ammo (LRM) 120	Level 5
2 SRT 6+Artemis	Level 5
Ammo (SRT) 120	Level 5
4 Medium Pulse Lasers	Level 5
2 Laser Anti-Missile Systems	Level 5

**Hexes 3, 6:  
Weapons and Equipment**

	<b>Hex/Location</b>
1 NL55	Level 10

**Hexes 5, 7:  
Weapons and Equipment**

	<b>Hex/Location</b>
2 Barracuda (30 Missiles)	Level 10

**Hexes 8, 12:  
Weapons and Equipment**

	<b>Hex/Location</b>
4 ER PPC	Turret
2 Large VSP Lasers	Turret
4 LRT 20+Artemis	Level 5
Ammo (LRT) 120	Level 5
4 ER Large Lasers	Level 5
4 SRT 6+Artemis	Level 5
Ammo (SRT) 120	Level 5
6 Medium Pulse Lasers	Level 5
4 Laser Anti-Missile Systems	Level 5

**Hexes 9, 11:  
Weapons and Equipment**

	<b>Hex/Location</b>
1 Killer Whale (24 Missiles)	Level 10

**Hexes 13, 15:  
Weapons and Equipment**

	<b>Hex/Location</b>
1 NL55	Level 10
2 ER PPC	Level 5
2 LRT 20+Artemis	Level 5
Ammo (LRT) 60	Level 5
2 SRT 6+Artemis	Level 5
Ammo (SRT) 120	Level 5
4 Medium Pulse Lasers	Level 5
4 Laser Anti-Missile Systems	Level 5

<b>Hex 14: Weapons and Equipment</b>	<b>Hex/Location</b>
1 Killer Whale-T (22 Missiles)	Level 10

**DRONE INDEPENDENT  
COMMAND RULES**

**Rules Level:** Experimental

**Available To:** Units mounting either Aerospace Smart Robotic Control System (ASRCS) or Caspar II Advanced Smart Robotic Control System (Caspar II) use these rules (see pp. 194 and 196, respectively). Such units are uniformly referred to as “drones.”

**Game Rules:** Drone units use the following rules when not under the control of another unit.

The Drone Independent Command Decision Tree (see pp. 192-193) consists of Events and Event Orders. During the End Phase of every turn that a drone is in independent operation (always for ASRCS drones, and when not under DTACS-control for *Caspar II* drones (see p. 197)), it will proceed through the Decision Tree in order from the beginning. If the Event’s Trigger is valid, then the drone will execute the order for that Event. If the Event’s Trigger is not valid, the drone proceeds to the next Event in the Decision Tree. An active drone restarts at the top of the Decision Tree once the end has been reached.

**Aggression Levels:** When an Event Trigger occurs, the drone will execute the default order for that Event based on the drone’s set Aggression Level. Aggression Levels are: Aggressive, Neutral, and Defensive. Each drone has a single Aggression Level assigned to it that applies to all Events. Aggression Levels are set at the start of game play for all drones that begin deployed on the playing area. Drones not deployed need not have their Aggression Level set until the turn they are deployed. The Aggression Level may be changed in the End Phase of any turn for drones under control of a Control Unit (see p. 195 and p. 196, respectively).

It is recommended a GM control drones under Independent Command to carry out orders described on the following pages.

**High-G Maneuvers:** Drones will use high-g maneuvers (see p. 78, *TW*) during combat, even if it means possible damage. How often they will use high-g maneuvers is based upon their Aggression Level (see above).

- **Aggressive:** Will always use high-g maneuvers.
- **Neutral:** Will only use high-g maneuvers when weapons are in range.
- **Defensive:** Will only use high-g maneuvers when weapons are in short range.

If a drone only has 1 SI remaining, regardless of Aggression Level, the drone will never use a high-g maneuver.

## DRONE INDEPENDENT COMMAND EVENT DECISION TREE



The following rules apply only to "drones," any unit mounting an ASRCS or a Caspar II system. If the rules refer to a specific system, those rules only apply to a drone mounting that system.

**Space Stations:** Drone Space Stations ignore all movement orders.

### OVERRIDING ORDERS

These orders will take effect whenever conditions are met, regardless of the Event Trigger activated.

**Target!:** If there is a hostile Large Craft in the drone's forward arc at short or medium range and the drone did not attack another target the previous turn, it will attack that Large Craft with all available weapons.

**Large Craft Priority Target:** *Caspar II* drones are programmed to target Large Craft as a priority. When selecting a valid target, drones will always choose the nearest hostile Large Craft in range unless overridden by another Event Order. When more than one Large Craft is equidistant from the *Caspar II* drone, use the Bearings Launch Capital Missile rules for target selection (see *Detection Phase, Standard Play*, p. 102, SO).

**No Large Craft Targets:** *Caspar II* drones are programmed to target Large Craft as a priority. If no valid hostile Large Craft is in range, it will fire on any valid hostile target. This is in addition to any action required by a triggered Event.

**Remaining Weapons:** If after firing all valid weapons at its primary target, a *Caspar II* drone has unfired weapons and sufficient heat sinks to fire them and the target is within range and appropriate fire arc, it will fire on the nearest hostile unit, regardless of size/class.

**Ramming:** ASRCS drones will not attempt a ramming attack. If a ramming attack is indicated, the drone will instead alpha strike with all weapons, even if this means it will overheat.

### 1. COLLISION

**Event Trigger:** Drone is in danger of colliding with another object. For *Caspar II* drones, if it meets conditions for Worst Case Event and the drone's Aggression Level is set to Aggressive, the *Caspar II* will execute the Omega Event Orders (at right). For ASRCS drones, treat the Aggression Level of "Aggressive" as "Neutral".

**Aggressive:** *Caspar II* only. If the possible collision is with any Small Craft or fighter or a non-friendly object that will do less than 20% total starting armor damage to the *Caspar II* drone, the drone will ignore the possible collision. Proceed to next Event in the Decision Tree.

**Neutral:** Unit will use all available thrust to avoid collision. Will continue to target hostile units and attempt to maneuver to remain in

combat with the nearest hostile unit (Large Craft for *Caspar II*)

**Defensive:** Unit will use all available thrust to avoid collision. It will forgo all other actions until it is no longer in danger of collision.

### 2. OMEGA

**Event Trigger:** Drone is crippled. An ASRCS drone is considered crippled under any of the following: it suffers a critical hit to its engine or fuel tank, all weapons are destroyed, it loses more than half its original Structural Integrity, or its pilot/crew suffers four or more hits. A *Caspar II* drone is considered crippled under any of the following: suffering three engine critical, all weapons are destroyed, loses more than half its original Structural Integrity, or receives enough critical hits that would kill the pilot/crew of a non-drone unit.

**Aggressive:** Unit will accelerate at maximum thrust toward the nearest hostile unit (Large Craft for *Caspar II*) in its forward arc. It will fire all weapons at the hostile target as it closes. Once in range, it will attempt to ram the hostile unit.

**Neutral:** Unit will attempt to keep all hostile Large Craft at long range, protecting its most damaged components. If unable to keep all hostile Large Craft at long range, it will attempt to stay at long range from the largest hostile Large Craft\*. Will attempt to attack the nearest hostile Large Craft\*. If the nearest hostile target (of any kind) is at short or medium range, it will conduct evasive maneuvers.

**Defensive:** Drone will conduct a Forced Withdrawal (see p. 258, TW) using evasive maneuvers when thrust permits. When it reaches the edge of the playing area, it will flee the battlefield, remaining out of play for the remainder of the game.

### 3. BOARDING

**Event Trigger:** If a Small Craft or ground unit operating in Zero-G (see p. 279, SO) enters the same or adjacent hex as the drone and has a relative velocity of 4 or less, the drone will react to the possible boarding attempt. Aerospace fighter drones ignore this Event Trigger.

**Aggressive:** Drone will not attempt to avoid the unit.

**Neutral:** Drone will spend the next Movement Phase expending up to Maximum Thrust to increase range with the unit or to increase relative velocity to 5 or greater.

**Defensive:** Drone will act as per Neutral orders and will also make the unit its primary target, firing all available weapons at the unit.

### 4. SWARM

**Event Trigger:** A hostile Large Craft or Small Craft (ASRCS only) is crippled and within

12 hexes (6 for ASRCS) of the drone. A drone considers a target crippled if the target has received two or more critical hits to its engine, if all weapons in three or more locations are destroyed, if it has lost more than half its original Structural Integrity, or if the crew has suffered four or more hits.

**Aggressive:** If the hostile Large Craft is a WarShip and the drone is a DropShip or Small Craft, it will immediately attempt to ram. Otherwise, the drone will close to short range and attempt to fire at the facing with the lowest current armor rating.

**Neutral:** Drone will shift fire from any active target and attack the crippled unit. It will attempt to fire at the facing with lowest current armor rating. It will close on the crippled unit using Safe Thrust.

**Defensive:** Drone will ignore the crippled unit and will move to the next Event.

### 5. SUPPORT

**Event Trigger:** Drone is not currently engaged with a hostile Large Craft and a friendly unit (drone or non-drone) is in active combat with a hostile target at short, medium, or long range from the drone.

**Aggressive:** Drone will engage friendly's hostile unit while attempting to close to short range.

**Neutral:** Drone will engage hostile unit while attempting to maintain current range band.

**Defensive:** Drone will engage hostile unit but will not change range bands. It will not pursue the target if it moves beyond the current range band.

### 6. TARGET: ENGAGE

**Event Trigger:** Drone is not engaged with a hostile Large Craft or Small Craft (ASRCS only) and there is a hostile Large Craft or Small Craft (ASRCS only) within range of any weapons mounted in its forward arc.

**Aggressive:** Drone will engage hostile unit while attempting to close to short range at any thrust.

**Neutral:** Drone will engage hostile unit while attempting to maintain current range band.

**Defensive:** Drone will engage hostile unit but will not change range bands. It will not pursue the target if it moves beyond the current range band.

### 7. TARGET: RANGE

**Event Trigger:** Drone is not currently engaged with a hostile Large Craft or Small Craft (ASRCS only) and there is a Large Craft or Small Craft (ASRCS only) within range of any weapons mounted in any arc.

**Aggressive:** Drone will move towards the nearest hostile unit\* at Maximum Thrust. It will



## DRONE INDEPENDENT COMMAND EVENT DECISION TREE

begin attacking as soon as its Modified To-Hit Target Number is 12 or less for any weapon. Once the Modified To-Hit Target Number is 11 or less, restart the Trigger Decision Tree.

**Neutral:** Drone will move towards the nearest hostile unit\* at Safe Thrust. It will begin attacking as soon as its Modified To-Hit Target Number is 12 or less for any weapon. Once Modified To-Hit Target Number is 10 or less, restart the Trigger Decision Tree.

**Defensive:** Drone will move towards the nearest hostile unit\* while evading. It will not exceed Safe Thrust. Once the Modified To-Hit Target Number is 9 or less, restart the Trigger Decision Tree.

**7A. TARGET: DETECTED**

**Event Trigger:** *ASRCS drones only.* Drone is not currently engaged with a hostile unit and there is a hostile unit within 50 hexes of the drone.

**Aggressive:** Drone will move towards the nearest hostile unit\* at Maximum Thrust. It will begin attacking as soon as its Modified To-Hit Target Number is 12 or less for any weapon. Once the Modified To-Hit Target Number is 11 or less, restart the Trigger Decision Tree.

**Neutral:** Drone will move towards the nearest hostile unit\* at Safe Thrust. It will begin attacking as soon as its Modified To-Hit Target Number is 12 or less for any weapon. Once Modified To-Hit the Target Number is 10 or less, restart the Trigger Decision Tree.

**Defensive:** Drone will move towards the nearest hostile unit\* while evading. It will not exceed Safe Thrust. Once the Modified To-Hit Target Number is 9 or less, restart the Trigger Decision Tree.

**8. TARGET: ACQUIRED**

**Event Trigger:** Drone is not currently engaged with a hostile unit (*Caspar II* only: Large Craft), and there are no hostile targets of any type within 100 hexes of the drone.

**Aggressive:** *Caspar II* drones will move towards the nearest hostile unit at Maximum Thrust. If the standard Maximum Thrust of the target (before any damage) is higher than the drone's current Maximum Thrust, it will choose the next closest target. If no target can be intercepted in this fashion, move to Event Trigger 10. *ASRCS* drones will maintain current heading and velocity, unless specifically commanded otherwise by a Control Unit (see p. 195). Restart the Trigger Decision Tree.

**Neutral:** *Caspar II* drones will move towards the nearest Large Craft\* at Safe Thrust. If the standard Maximum Thrust of the target (before any damage) is higher than the drone's current Safe Thrust, it will choose the next closest target. If no target can be intercepted

in this fashion, go to Event Trigger 10. *ASRCS* drones will expend Safe Thrust to lower its velocity to 0 (i.e. it will remain in its current position), unless specifically commanded otherwise by a Control Unit (see p. 195). Restart the Trigger Decision Tree.

**Defensive:** *Caspar II* drone will move towards the nearest Large Craft\* while evading. It will not exceed Safe Thrust. If the standard Maximum Thrust of the target (before any damage) is higher than the drone's current Safe Thrust, it will choose the next closest target. If no target can be intercepted, go to Event Trigger 10. *ASRCS* drones will expend Safe Thrust to lower its velocity to 0 (i.e. it will remain in its current position), unless specifically commanded otherwise by a Control Unit (see p. 195). Restart the Trigger Decision Tree.

**9. MINIMAL THREAT**

**Event Trigger:** No hostile target within 100 hexes of the drone (50 for Small Craft and aerospace drones) or any hostile Large Craft or Small Craft (*ASRCS* only) within 100 hexes (50 for Small Craft, and aerospace fighter drones) that have a Maximum Thrust less than the drone's current Maximum Thrust.

**Aggressive:** *Caspar II* drones will move at Maximum Thrust in the direction of the nearest hostile Large Craft. If thrust is insufficient to intercept (see *Target: Acquired, Aggressive*), it will expend Safe Thrust to lower its velocity to 0 (i.e. it will remain in its current position). *ASRCS* drones will expend Safe Thrust to lower its velocity to 0, unless specifically commanded otherwise by a Control Unit (see p. 195). Restart the Trigger Decision Tree.

**Neutral:** *Caspar II* drones will move at Safe Thrust in the direction of the nearest hostile Large Craft. If thrust is insufficient to intercept (see *Target: Acquired, Aggressive*), it will expend Safe Thrust to lower its velocity to 0 (i.e. it will remain in its current position). *ASRCS* drones will expend Safe Thrust to lower its velocity to 0, unless specifically commanded otherwise by a Control Unit (see p. 195). Restart the Trigger Decision Tree.

**Defensive:** Drone will expend Safe Thrust to lower its velocity to 0 (i.e. it will remain in its current position). *ASRCS drone only:* if within 250 hexes of a friendly fighter bay-equipped unit it will expend Safe Thrust to intercept allied unit and dock. Otherwise lower velocity to 0, unless specifically commanded otherwise by a Control Unit (see p. 195). Restart the Trigger Decision Tree.

**10. BINGO TARGETS**

**Event Trigger:** No hostile targets within battlefield radar detection range (555 hexes for

Large Craft, 55 hexes for Small Craft, Satellites, and aerospace).

**Aggressive:** Drone will make an active Detection Roll (see *Radar (Object)*, p.119, SO) every turn. *Caspar II only:* when a Large Craft is detected, start at the top of the Decision Tree. *ASRCS only:* when a target is detected within 50 hexes, go to Event Trigger 7A.

**Neutral:** *Caspar II* drones will expend Safe Thrust to lower its velocity to 0 (i.e. it will remain in its current position). It will conduct passive sensor sweeps for hostile targets; when a Large Craft is detected, start at the top of the Decision Tree. *ASRCS drone only:* if within 250 hexes of a friendly unit with a fighter bay, it will expend Safe Thrust to intercept allied unit and dock. Otherwise, lower its velocity to 0. Restart the Trigger Decision Tree.

**Defensive:** *Caspar II* drones will deactivate and can only be re-activated by a DTACS-equipped unit. *ASRCS drone only:* if within 250 hexes of an allied unit with an equipped fighter bay, it will expend Safe Thrust to intercept allied unit and dock. If there is no unit within range, drones will deactivate. Drone will not reactivate until it receives an activation command from a designated controller unit. Any drone in a deactivated state will cease to process command triggers until reactivated.

**11. HIBERNATION**

**Event Trigger:** *Caspar II* drones only. No hostile targets within radar detection range (5,555 hexes for Large Craft and 555 hexes for Small Craft).

**Aggressive:** *Caspar II* drone will conduct a patrol of the area, moving 1,000 hexes in a random direction and accelerating the first 500 hexes, then decelerating until it reaches 0 velocity. If no hostile Large Craft are detected, the unit will return to its original position and repeat the above process in a new direction. At anytime a hostile Large Craft is detected, start at the top of the Decision Tree.

**Neutral:** *Caspar II* drone will expend Safe Thrust to lower its velocity to 0 (i.e. it will remain in its current position). At anytime a hostile Large Craft is detected, start at the top of the Decision Tree.

**Defensive:** *Caspar II* drone will deactivate. It will not reactivate until it receives an activation command from a DTACS-equipped Control Unit. Any *Caspar II* drone deactivated will cease to process command triggers until reactivated (see *Deactivated*, p. 197).

\*When more than one Large Craft is equidistant from the *Caspar II* drone, use the Bearings Launch Capital Missile rules for target selection (see *Detection Phase, Standard Play*, p. 102, SO).

## RULES ANNEX

## NEW EQUIPMENT

The following new equipment allows for the use of the drones that comprise part of the Word of Blake's SDS system.

## AEROSPACE SMART ROBOTIC CONTROL SYSTEM (ASRCS)

**Introduced:** 2600

**Extinct:** 2780 (Inner Sphere), circa 2850 (Clans)

**Recovered:** 3069 (Word of Blake)

Using sophisticated "smart" programming to simulate artificial intelligence but designed for simple tasks, robotic control systems (RCS) completely lack a human component and rely entirely on their own on-board sensors for input. While this makes these drones superior to those mounting remote drone systems—a drone carrier controller is not needed—they are still susceptible to ECM while their rigid programming often leaves them unable to adapt to changing environments.

## AEROSPACE SMART ROBOTIC CONTROL SYSTEM (ASRCS)

**Rules Level:** Advanced

**Available To:** AF, SC, SA, and SS

**Tech Base (Ratings):** Inner Sphere (D-X-F), Clan (X-E-E)

**Game Rules:** Except where specifically noted otherwise below, units mounting the Aerospace Smart Robotic Control System operate per the standard rules for a given unit type.

Units using an ASRCS are automatically considered to have a Crew of 0 for game play purposes, regardless of the construction rules for said unit, and may not use crew-served equipment beyond weapons, communications, and sensors. A drone's Piloting or Gunnery Skill is determined by its type as well as how much mass is devoted to the control system (see the ASRCS Equipment Table, p. 196).

**Initiative:** In game play, drones mounting an ASRCS operate with their own Initiative roll, which receives a -4 modifier. Even if friendly non-drone or *Caspar II* drones are present, the ASRCS drones operate on their own initiative and are not counted as part of their player's force.

**Other Actions & Equipment:**

Drones mounting an ASRCS move in accordance with the standard rules for their unit type (though drones also cannot perform ramming attacks), and may make sensor sweeps and use unmanned

communications systems (see *Advanced Sensors*, p. 117, SO). They may also operate any and all mounted weapons per normal rules for the drone unit's type regardless of crew needs but cannot make secondary attacks. For targeting purposes, drone units ignore modifiers for operating with insufficient crew. Drone units can mount any other equipment that requires crew to operate (such as MASH units, field kitchens, etc.), but may not use these items or conduct field repairs without human crew.

**Heat:** Drones mounting an ASRCS operate within certain predefined limits intended to maximize their survivability. Drones that track heat will not deliberately exceed their heat management systems, and will not use any equipment that generates heat in excess of their heat sinks. Heat from external sources (such as fire, flammers, and plasma weapons) may force a drone into higher heat levels. A drone that exceeds 14 points of Heat can perform no other action beyond basic movement at a Safe Thrust rate.

**Critical Hits:** Critical hits against drones mounting an ASRCS that would normally stun or wound the pilot/crew do not have a permanent affect on drones. However, critical hits to a drone's pilot/crew are still tracked. In the turn following any critical hits that would stun or wound a pilot/crew, treat the drone as having a Piloting/Gunnery Skill one higher than

normal. If no critical hits that would wound/stun a pilot/crew occur during that turn, the Piloting/Gunnery Skill returns to its standard ratings at the start of the following turn. Once a drone receives a critical hit that would kill the pilot/crew, that critical hit destroys the drone's ASRCS, rendering the drone deactivated and immobile for the remainder of the game.

Additionally, drones suffer no pilot damage effects for high-G maneuvers (see pp. 78, *TW*, and 36, *SO*), nor will they suffer pilot damage effects from overheating or hazardous environments.

**Independent Command Rules:**

Drones mounting ASRCS follow the Drone Independent Command Rules (see p. 191) to determine their actions in combat. ASRCS drones must note their Aggression Level at the start of game play and may not change them unless they receive an order from a Control Unit (see below). If an ASRCS drone is controlled by a Control Unit, the controlling player may change the Aggression Level during the End Phase of any turn. However, it does not take effect until the Initiative Phase two turns after the change was issued.

**Electronic Warfare:** ASRCS drones are unaffected by ECM mounted on ground units. If using the Electronic Warfare rules (see p. 110, *SO*), at the end of any Movement Phase where an ASRCS drone is within a hostile ECM field from a

## RULES ANNEX

## AEROSPACE SMART ROBOTIC CONTROL SYSTEM (ASRCS)

non-ground unit (including being struck by an AESW missile (see p. 358, *TO*)), then the drone's systems will be overwhelmed and the controlling player should roll 1D6:

- On a result of 4 or less, the drone will suffer a +1 modifier to all Piloting and Gunnery Skill Rolls when within a hostile aerospace fighter, Small Craft, or Large Craft (except WarShips) ECM field, and a +2 modifier in a hostile WarShip ECM field. This is cumulative with any critical hit effects. It will also be unable to receive any commands from a controller unit, but will otherwise operate as normal.
- On a result of 5, the drone will drift in the direction it was headed at the time but takes no other actions for 1 turn. (If any other unit lies in its path, the controlling player should treat the effect as a ramming attack with a +4 to-hit modifier). In addition, no commands may be issued by a controller unit during this time.
- On a result of 6, the drone goes berserk and attacks the nearest active unit of any type, regardless of friendly or hostile, with any on-board weapons in range for as long as it remains within the area of a hostile ECM bubble.

**Boarding Rules:** When conducting boarding operations (see *Infantry vs. Infantry Action*, p. 199, *TO* and p. 36, *SO*), the Marine Point score of Small Craft or Satellite equipped with an ASRCS is 1.

**Fighter Squadrons:** ASRCS drones follow all the standard rules for fighter squadrons (see p. 27, *SO*), with the following exceptions:

- ASRCS drones and human-piloted fighters may not be part of the same squadron.
- Only drones of the same skill level may be in a squadron.
- Drone squadrons can only be formed prior to the beginning of game play and will not split into individual fighters under any circumstances.

**Control Units:** Friendly non-drone units may be designated as a Control Unit for friendly ASRCS drones prior to the start

of a scenario using the following rules:

- A Control Unit can never issue more than one command to an ASRCS drone per turn. All commands must be announced at the start of a turn with the command taking affect at the end of the turn.
- Only four commands can be issued to an ASRCS drone by a Control Unit: Activate, Deactivate, Change Aggression Level, and Designate Priority Target:
  - o **Activate:** Activates a deactivated drone.
  - o **Deactivate:** Deactivates (shuts down) an active drone (see *Deactivated*, below).
  - o **Change Aggression Level:** Changes the Aggression Level of a drone (see *Aggression Level*, p. 191). When issuing the command, the controlling player simply announces the new Aggression Level for that drone.
  - o **Designate Priority Target:** Designating a priority target has the effect of overriding the automatic target selection process used in the Drone Independent Command Rules (see p. 191). Instead, the player designates the target to attack; however, all other rules from the Drone Independent Command Rules still apply.
- Drones in a fighter squadron (see p. 27, *SO*) are treated as a single unit for the purposes of issuing commands.
- Aerospace fighters and Small Craft may only issue one command to a single friendly drone per turn and do so in place of their normal Weapon Attack Phase (i.e. the Control Unit cannot make any attacks in the turn they issue a command).
- Large Craft may issue multiple commands to multiple friendly drones per turn. Each command beyond the first reduces the number of arcs it can fire from in that turn, with the player choosing which arcs cannot fire that turn. For example, if a controlling

player of a Large Craft issues three commands to three different drones; the player would then need to designate two firing arcs that are unavailable during the Weapon Attack Phase of that turn.

- To issue any command, a friendly drone must be within the Control Unit's line of sight. Note that in atmosphere, line of sight is 80 kilometers (about 160 *BattleTech* mapsheets) before ground clutter and background interference renders the command incoherent. Outside of an atmosphere, line of sight is 3 million kilometers, after which communications lag makes any drones far less responsive to control.
- If a unit mounts a Naval Comm-Scanner Suite (see *NCSS*, p. 332, *TO*), the rules above are modified as follows:
  - o A unit that mounts a Small NCSS may send two commands per firing arc; a Small Craft may send two commands total.
  - o A unit that mounts a Large NCSS may send three commands per firing arc. In addition, LOS range is doubled.

**Deactivated:** A drone that is deactivated becomes immobile. Airborne drones in the space/atmosphere interface, atmospheric row, or ground row of hexes on the High-Altitude Map fall 1 hex per turn of inactivation, beginning during the Movement Phase (Aerospace) of the turn following. If there are two equal hexes to fall into, randomly determine which hex the unit enters. If players are using Low-Altitude Movement, the airborne drone falls three altitudes each turn. If it enters a Ground Hex (on the High-Altitude Map) or Altitude 0 (if using Low-Altitude Movement), the airborne drone crashes. Drones operating in space under these conditions continue along their last heading and speed, expend no thrust, and take no actions. If the drone is reactivated at some point and the drone is not destroyed, the drone resumes normal operation.

## RULES ANNEX

### ASRCS

#### CONSTRUCTION RULES

**Construction Rules:** Consult the Aerospace Smart Robotic Control System (ASRCS) Equipment Table (see below) for the weight of the equipment to be installed. For units weighing less than 10 tons in total mass, the robotic control system adds no weight beyond that of the unit's existing control systems. For units 10 tons and over, the ASRCS adds extra weight as a percentage of the unit's total weight to the tonnage of any basic cockpit or control systems already employed by the unit. In all other respects, the unit follows its standard construction rules. Note: If the unit requires weight to be spent on life-support systems, the drone unit is *not* exempt from this requirement.

### ASRCS EQUIPMENT TABLE

Unit Type	Gunnery	Piloting/ Driving	Mass
Conventional Fighter	5	6	5%
Aerospace Fighter	5*	6*	5%
Small Craft	5*	6*	5%
Satellite	5	6	5%
Space Station	5*	6*	7%

\* An additional 2% mass will lower skills to 4/5. This may only be done once (the modification is referred to as "improved").

### CASPAR II ADVANCED SMART ROBOTIC CONTROL SYSTEM (CASPAR II)

**Introduced:** 3064 (Word of Blake)

**Extinct:** N/A

**Recovered:** N/A

While unable to replicate the ability of the true autonomous artificial intelligence systems that made the original *Caspar* system so deadly, the Word of Blake made substantial improvements in the ability of Star League era Smart Robotic Systems (SRS).

The original SRS grew out of industrial applications and was heavily based on "laws" that limited the system's ability to operate outside of their specific program guidelines. Seeking a more aggressive combat platform in line with the original *Caspar*, Word scientists developed algorithms that gave these systems significantly greater autonomy. The *Caspar II* system would still lack true autonomy but was now able to adapt to situational events and better execute actions from a series of pre-determined generic mission instructions. Additionally, the removal of some of the foundational "laws," which called for the preservation of life and self, improved the *Caspar II*'s combat ability and their ability to operate in a hostile ECM environment.

### CASPAR II ASRCS (CASPAR II)

**Rules Level:** Experimental

**Available To:** SC, DS, WS, and SS

**Tech Base (Ratings):** Inner Sphere (E-X-F)

**Game Rules:** Units mounting the *Caspar II* Advanced Smart Robotic Control System (*Caspar II*) are an amalgamation of direct Tele-Operated control and independent SRS operations. When operating under direct control, an operator sitting in a Direct Tactical Analysis Computer (DTACS)-equipped control ship (see p. 198) provides basic instruction to the drone, such as "Attack this target, focus on the rear," or "Harass this formation of ships from long range." The drone then carries out the specifics of the commands using its onboard computer systems. When operating under independent control, their behavior is dictated by a list of pre-determined events and reactionary orders (see *Drone Independent Command Rules*, p. 191).

*Caspar II* drones are automatically considered to have a Crew of 0 for game play purposes, regardless of the construction rules for said unit, and may not use crew-served equipment beyond weapons, communications, and sensors. A *Caspar II* drone's Piloting and Gunnery Skill is determined by its type and how much mass is devoted to the control system (see the *Caspar II* ASRCS Equipment Table, p. 198).

**Basic features:** *Caspar II* drones move in accordance with the standard rules for their unit type. Aside from the below exceptions, drone units function per the rules for their applicable unit type, including other critical hit effects and all effects due to heat.

**Attacks & Commands:** As long as the *Caspar II* drone is in communication contact with its Control Unit (see *Direct Tactical Analysis Computer (DTACS)*, p. 198), it operates like any other manned player-controlled unit. They may also operate any and all mounted weapons per normal rules for the unit's type, regardless of crew needs. For targeting purposes, *Caspar II* drone units ignore modifiers for operating with insufficient crew. *Caspar II* drones may target multiple targets in a turn. The first two targets in a turn receive no to-hit modifier, with the third and subsequent targets receive a +1 to-hit modifier.

Additionally *Caspar II* drones can be instructed to conduct ramming attacks (see p. 241, *TW*), by their Control Unit, on any



## RULES ANNEX

### CASPAR II ASRCS (CASPAR II)

Control Roll of 7 or higher or as a result of Overriding Orders (see p. 192).

**Initiative:** In game play, all *Caspar II* drones operate on a separate team Initiative roll and receives a -2 modifier. Even if friendly non-drone units or other non-*Caspar II* drones (see *Aerospace Smart Robotic Control System (ASRCS)*, p. 194, and *Drone (Remote) Systems*, p. 305, *TO*) are present, the *Caspar II* drones operate on their own Initiative and are not counted as part of their player's force for initiative purposes.

**Heat:** *Caspar II* drones operating independently will not deliberately exceed their heat management systems and will not use any equipment that generates heat in excess of their heat sinks. Heat from external sources (such as fire, flamers, and plasma weapons) may force a drone into higher heat levels. A *Caspar II* drone that passes a heat level of 14 points will move at maximum thrust away from combat (player's discretion) while evading, until their heat has returned to zero. *Caspar II* units under DTACS control (see p. 198), are treated as regular units and follow all applicable heat rules for the given unit type and rules in play.

**Critical Hits:** Critical hits against *Caspar II* drones that would normally stun or wound the pilot/crew do not have a permanent affect on drones. Critical hits to a drone's pilot/crew are still tracked. Once a drone receives a critical hit that would kill the pilot/crew, that critical hit destroys the drone's ability to send/receive communications from its Control Unit. *Caspar II* drones in this situation will Trigger the current orders for the "Omega" Trigger at the start of the Phase following the Phase in which the final critical damage occurred (see *Overriding Orders*, p. 192). The distributed nature of their drone systems results in no additional negative effects to a *Caspar II* and the drone will continue to operate until destroyed or deactivated.

Additionally, drones suffer no pilot damage effects for high-G maneuvers (see pp. 78, *TW*, and 36, *SO*), nor will they suffer pilot damage effects from overheating or hazardous environments.

**Other Actions & Equipment:** *Caspar*

*II* drones may make sensor sweeps and use unmanned communications systems (see *Advanced Sensors*, p. 117, *SO*). Drones units can carry any other equipment that requires crew to operate (such as MASH units, field kitchens, etc.) but may not use these items or conduct field repairs without human crewmen. An exception is the Advanced Robotic Transport Bay Systems (see p. 199).

**Electronic Warfare:** If using the Electronic Warfare rules (see p. 110, *SO*), *Caspar II* systems operating independently follow the standard ECM/ECCM rules and do not suffer interference like drones mounting ASRCS. Additionally, as a byproduct of their drone communication systems, increase a *Caspar II* drone's ECM zone of effect by one hex for the class of unit: WarShips would have a 3 hex ECM field, DropShips 2, and Small Craft 1 hex.

**Anti-Ship Electronic Warfare Missiles:** If an AESW missile (see p. 358, *TO*) successfully strikes a *Caspar II* drone, the drone will lose contact with its Control Unit for 1D6/2 turns. Roll 1D6: On a 1 the *Caspar II* drone will take no actions; if it exits the map during this time it may not return to the battle. On a 2-6 it will enter Independent Control (see *Overriding Orders*, p. 192). After 1D6/2 turns, the interference ceases and the *Caspar II* drone may restore normal communication with its Control Unit. Additional hits in the same turn have no additional affect, but ASEW hits in subsequent turns will extend the interference by 1D6/2.

Additionally, a *Caspar II* that is struck by an AESW missile will automatically deactivate on a roll of 3 or higher on 1D6; the roll is made during the End Phase of any turn following the phase in which the drone was struck by an AESW missile.

**Boarding Rules:** When conducting boarding operations (see *Infantry vs. Infantry Action*, p. 199, *TO* and p. 36, *SO*), the Marine Point score of a *Caspar II* drone is as follows:

For every 7 tons devoted to general crew, the *Caspar II* drone receives 3 Marine Points. For every 7 tons devoted to Gunners, the *Caspar II* drone receives

1 Marine Point. These Marine Points represent the narrow access ways, sealed compartment structure and internal automated anti-personnel weapon systems.

**Deactivated:** A drone that is deactivated becomes immobile. Airborne drones in the space/atmosphere interface, atmospheric row, or ground row of hexes on the High-Altitude Map fall 1 hex per turn of inactivation, beginning during the Movement Phase (Aerospace) of the turn following. If there are two equal hexes to fall into, randomly determine which hex the unit enters. If players are using Low-Altitude Movement, the airborne drone falls three altitudes each turn. If it enters a Ground Hex (on the High-Altitude Map) or Altitude 0 (if using Low-Altitude Movement), the airborne drone crashes. Drones operating in space under these conditions continue along their last heading and speed, expend no thrust, and take no actions. If the drone is reactivated at some point and the drone is not destroyed, the drone resumes normal operation.

**Drone Independent Command:** Optimized to operate under the control of a DTACS-equipped Control Unit, the *Caspar II* system is also capable of extensive independent operations. Improved filtering limits the direct impact of electronic warfare and an enhanced logic system allows the *Caspar II* system to execute or fall back on an independent command decision tree. When operating independently, the *Caspar II* system will use the Drone Independent Command Event Decision Tree (see pp. 192-193) to determine how it will react to battlefield events.

A *Caspar II* drone can be set to Independent Command (IC) at the start of any turn. In addition any *Caspar II* drone that loses contact with its Control Unit will automatically revert to IC. The controlling player can announce at the start of any turn that any DTACS-equipped unit is taking direct control of an IC *Caspar II* drone (provided it is not exceeding the number of drones it can control). On the following turn that *Caspar II* drone will be under control of the DTACS-equipped unit.

## RULES ANNEX

### CASPAR II ASRCS (CASPAR II)

CONSTRUCTION  
RULES

**Construction Rules:** Consult the Caspar II ASRCS Equipment Table below for the weight of the equipment to be installed. Caspar II controls add extra weight as a percentage of the unit's total weight. *Caspar II* drones must still devote tonnage to quarters for all required minimum crew (officers, gunners, crew, bay personnel, etc.), representing various automation and internal maintenance units and access ways (see *Add Control/Crew Systems*, pp. 188, *TM*, and 149, *SO*). Calculate base crew as normal for the drone unit's type and dividing the result by half, rounding up to the nearest whole number. Gunner crew tonnage is added per normal construction rules for the drone class. This tonnage represents additional fire control and automatic maintenance systems. In all other respects, the drone follows its unit's standard construction rules.

### CASPAR II ASRCS EQUIPMENT TABLE

Unit Type	Gunnery	Piloting/ Driving	Mass
Small Craft	5*	6*	6%
DropShip	4**	5**	8%
Space Station	4**	5**	10%
WarShip	4**	5**	12%

\* Additional 2% tonnage will increase skills to 4/5

\*\* Additional 4% tonnage will increase skills to 3/4

### DIRECT TACTICAL ANALYSIS CONTROL SYSTEM (DTACS)

**Introduced:** 3072 (Word of Blake)

**Extinct:** N/A

**Recovered:** N/A

The Direct Tactical Analysis Control System (DTACS) is a Word of Blake attempt to manually copy the more advanced Autonomous Tactical Analysis Control System (ATACS) of the Star League. Essentially a supersized Tele-Operated control system, the DTACS combines the Draconis Combine's Naval C<sup>3</sup> technology with Tele-Operated control systems. Human operators control each of the *Caspar II* drones from the DTACS-equipped ship. The operators are less direct controllers for *Caspar IIs* and more guides to the on-board semi-autonomous systems. The DTACS also allows for sensor and tactical data to be shared between the *Caspar II* drones linked to the same DTACS. Squadrons of up to six drones can also be linked together to share targeting data.

### DIRECT TACTICAL ANALYSIS CONTROL SYSTEM

**Rules Level:** Experimental

**Available To:** WS, SS, and MS

**Tech Base (Ratings):** Inner Sphere (F-X-X-F-F),

**Game Rules:** While more than one unit per force can be equipped with a DTACS, only one can be connected to a given *Caspar II* drone at any given time. In addition, the total tonnage of the force that can be controlled is limited by the mass of the active DTACS.

When multiple DTACSs are present the controlling player must secretly note which one is designated as the active controller for a given *Caspar II* drone. This information must be revealed to their opponents when any unit equipped with an active probe moves within 6 hexes of the active DTACS Control Unit. Note that the active controller can be situated off-board. Should a player wish to switch control from one DTACS to another, or to have a new DTACS take over when another is destroyed, the player must announce this during the End Phase; all *Caspar II* drones being controlled by the replaced DTACS will operate in Independent Command mode (see p. 197) for the following two full game turns.

Units operating as part of a DTACS-controlled formation receive modifiers to their group Initiative rolls and Piloting and Gunnery Skills. This reflects the command and control nature of the Naval C<sup>3</sup> network, which allows the units to share combat data. These bonuses degrade with the distance they are from the DTACS-equipped unit that is directing them (see DTACS Modifier Table, next page).

**Naval C<sup>3</sup>:** The DTACS provides the same ability as a Naval C<sup>3</sup> to its *Caspar II* drones (see p. 332, *TO*). While controlled by their designated DTACS, up to six drones can be linked together to share targeting data. These can either be six drone units or up to five drones and the DTACS controller unit. Any drone actively in a hostile Large Craft ECM field is unable to share or benefit from shared targeting data. Only a unit under active DTACS control can share or benefit from shared targeting data.





**DIRECT TACTICAL ANALYSIS CONTROL SYSTEM**

**DTACS MODIFIER TABLE**

Range	Piloting/Gunnery	Initiative*
0-50	-1	+4
51-100	-1	+2
101- to Off-board	-0	+0

\*Caspar II drones have a base Initiative of -2

**Electronic Warfare:** If using the Electronic Warfare rules (see p. 110, SO) the ECM effects can interfere with a Caspar II drone's ability to communicate with its Control Unit.

In the End Phase of each turn, the Caspar II drone checks its line of sight to its DTACS-equipped Control Unit. If there is a hostile ECM field between the Caspar II drone and the Control Unit, make an immediate ECCM roll by the Control Unit and apply any ECCM modifiers to hostile ECM as if it were targeting the Caspar II drone. If the Control Unit counteracts the hostile ECM, the Caspar II drone operates normally.

If ECM interference is equivalent to a +1 to-hit modifier, on the subsequent turn the Caspar II drone has an Initiative equal to two less than that rolled by the controlling player for all their Caspar IIs. It also applies an additional +1 to-hit modifier at Long and Extreme range. For example, if the player rolled an Initiative of 6 for his Caspar II drones, then the Caspar II affected by ECM would have an initiative of 4.

If ECM interference is equivalent to a +2 to-hit modifier, the Caspar II drone receives an additional -2 Initiative modifier and applies a +1 to-hit modifier at all ranges.

If ECM interference is equivalent to a +3 or +4 to-hit modifier, then the Caspar II drone is out of communication with its Control Unit and reverts to Independent Command and loses all Piloting/Gunnery Skill bonuses conveyed by the DTACS (see *Drone Independent Command Rules*, p. 197).

At any time, while still in communication, the DTACS can order the Caspar II drone to switch to Independent Command (see p. 197), avoiding these negative modifiers (but will also lose any bonus modifiers to initiative or piloting/gunnery). Such an order takes effect at the start of the turn following the turn in which the order was issued.

During the Weapon Attack Phase, after rolling ECCM again, follow the same process as above, to determine any to-hit modifier effects.

**S ANNEX**

**ADVANCED ROBOTIC TRANSPORT SYSTEM (ARTS)**

**Introduced:** 2709

**Extinct:** 2804 (IS)

**Recovered:** 3068 (Word of Blake)

The ability for Star League-era Caspar drone systems to launch and recover themselves and even perform basic maintenance such as ammo loading and refueling was built upon earlier advances in robotic warehouse technologies. The Terran Hegemony's SDS took this to the point that entire starports supported their Caspar drone WarShips. The robotic transport bay took the terrestrial bound technology and applied it to space going vessels. While greatly streamlining shipping and reducing crew sizes, in most applications it never replaced crews completely. The Advanced Robotic Transport System (ARTS) removed the final human components and was developed as part of the Terran Hegemony's SDS systems.

**ADVANCED ROBOTIC TRANSPORT SYSTEM**

**Rules Level:** Advanced

**Available To:** SA, DS, SS, and WS

**Tech Base (Ratings):** Inner Sphere (D-X-F), Clan (X-E-E)

**Game Rules:** A unit equipped with this system requires no Bay Personnel to perform launch/recovery, ammunition loading/unloading or small craft/fighter refueling. Drone units equipped with an ASRCS may launch and recover small craft and fighter (drone or human controlled) as if they were a normally crewed unit.

**ADVANCED ROBOTIC TRANSPORT SYSTEM**

CONSTRUCTION RULES

**Construction Rules:** ARTS may be installed individually and may be installed in the same unit as a standard Transport Bay. If both types of Transport Bays are present in a single unit, indicate the ARTS bays by placing (ARTS) in parentheses after the name of the bay. ARTS bays weigh an additional 25% over the standard bay tonnage (i.e. a fighter ARTS bay weighs 187.5 tons instead of 150).

**DIRECT TACTICAL ANALYSIS CONTROL SYSTEM**

CONSTRUCTION RULES

**Construction Rules:** The DTACS has a base weight of 3% of the Control Unit's weight plus 150 tons per Caspar II drone it is intended to control. Additional crew space must be allocated, equal to one crew per drone controlled. There is no limit to the number of drones a Control Ship can control.



## RULES ANNEX

## "DRAGON'S BREATH" MULTIPLE CAPITAL MISSILE LAUNCH SYSTEM

**Introduced:** 3077

**Extinct:** 3078

**Recovered:** N/A

Part of the Megiddo system, the "Dragon's Breath" was an attempt to marry the SRMs multiple missile launch ability, along with the capability to air-launch the massive peacemaker nuclear warhead with phantom target-generating ECM and precision launch timing. The "Dragon's Breath" proved to be a relative one-hit wonder, as only a handful of systems ever built operated as designed. The remaining units either failed to launch, generated phantom targets to chase, or simply exploded upon launch.

### "DRAGON'S BREATH" MCMLS

**Rules Level:** Experimental

**Available To:** SS

**Tech Base (Ratings):** Inner Sphere (X-X-F)

**Game Rules:** The "Dragon's Breath" will only attack Large Craft over a given weight. This weight must be set prior to the start of the game. If a hostile unit of that weight or higher enters medium range from the launcher, roll 2D6. On a result of 8+ the system will launch, targeting the nearest unit that meets or exceeds its weight rating. When more than one target is equidistant from the Dragon's Breath, use the Bearings Launch Capital Missile rules for target selection (see *Detection Phase, Standard Play* p. 102, SO).

If any valid target enters the launcher's short range band, it will automatically fire. Any allied unit equipped with a Naval Comm-Scanner Suite and within communications range may also order a "Dragon's Breath" to fire. In this case, a successful launch will use the Bearings Launch rules (see p. 100, SO) until the missiles are in range of a valid target.

When successfully fired, the Dragon's Breath fires ten Killer Whale missiles. Four missiles are ECM tipped and the remaining six are tipped with either standard or Peacemaker warheads (see p. 294, *Blake Ascending*), determined before the start of the game.

**Weapons Fire Phase:** The "Dragon's Breath" weapon attack occurs in a series of steps, as shown below.

- **Step 1: Firing Weapon:** To fire the system, roll 2D6:
  - On a result of 2, the system self-destructs; immediately apply damage from all six warhead missiles directly to a random location on the unit mounting the Dragon's Breath.
  - On a result of 3-7, the system fails to fire; all circuits burn out and the system is considered destroyed for the duration of the game.
  - On a result of 8 or more, the system will successfully launch at its designated target.
- **Step 2: If Weapon Fires:** If the controlling player rolled an 8 or higher on previous roll, roll 2D6 once more:

### "DRAGON'S BREATH" MCMLS

- On a result of 8 or less indicates the missiles collide with one another, detonating prematurely (no additional effects from the attack are applied).
  - On a result of 9 or more, the attack continues.
  - **Step 3: Generating Phantom Targets:** If the controlling player rolled a 9 or higher on the "If Weapon Fires" roll, roll 2D6 once more (the ECM missiles are attempting to generate phantom targets; see below):
    - On a result of 2-3, the ECM missiles burn out the guidance systems of the warhead-equipped missiles, rendering them ineffective (no additional effects from the attack are applied).
    - On a result of 4-7, no phantom targets are generated.
    - On a roll of 8-10, each ECM missile generates two phantom targets.
    - On a roll of 11 or 12 each missile generates five targets each.
  - **Step 4: To Hit Rolls:** If the controlling player rolled a 4 or higher on the "Generating Phantom Targets" roll, use the following rules: To-hit rolls are made according to standard rules for capital missile fire. Roll to hit for each missile. For any missiles that hit, resolve damage in three phases:
    - Apply the damage and any criticals for the first two missiles.
    - All damage and critical hits take effect immediately.
    - Apply the damage and any criticals for the the next three missiles.
    - All damage and critical hits take effect immediately.
    - Apply damage for the remaining missile.
- Point Defense:** Point Defense against a Dragon's Breath attack will always strike a random target. Determine how many active missiles there are (including phantom targets) and randomly determine which missile is targeted by the Point Defense weapon.
- Anti-Missile Systems:** AMS systems may also be fooled by phantom targets. Each time an AMS fires at a Dragon's Breath attack in a turn, roll 2D6. On a result of 7 or less, the AMS fire fails to hit the incoming warhead-equipped missile.
- Damage To Attacker:** Due to the nature of the launch systems, a successful Dragon's Breath launch will do 10 points of capital scale damage to the armor of the unit that mounts it (randomly determine the location).

### "DRAGON'S BREATH" MCMLS

**Construction Rules:** The Dragon's Breath system may only be mounted in an unpressurized repair bay with a capacity of five thousand tons or more; the player determines which single firing arc the weapon is mounted in.



## CASTLES BRIAN

—An Excerpt from *Castle Building: An Empire Imperative*, by Augustine Molaro, Donegal Press, 3079

The technological supremacy of the Terran Hegemony is something that has never been repeated. The Clans, direct descendents of the Royal Army, sacrificed much to master the biological and military sciences they have perfected, leaving them either unable (or unwilling due to cultural traditions) to try and fully implement the Castle Brian concept. ComStar, self-described guardians of mankind's "light" was unable to maintain all that they had inherited. Despite holding the cradle of mankind and all the resources of the Hegemony's capital world, they lost much of the understanding for all the knowledge they possessed. Dozens of diseases, all but eradicated during the Star League, have returned as planet-threatening horrors. Stasis chambers, true headhunter missiles, and weather control satellites are just a few technologies that have been lost since the last Cameron sat in Unity City. None of these lost technologies stands out more prominently than the Castle Brian.

Where a secret Star League base is a lifetime dream of a Lostech prospector, a Castle Brian is the Holy Grail. These massive complexes were feats of engineering beyond what many of us can even imagine today. Diverting an entire sea to build a Brian on the seabed and then flooding it once more, or DropShip-sized doors that disappear into the mountainside even under the most determined sensors, are but a few examples of the lengths Hegemony engineers went in the construction of these fabled fortresses. Inheritors of Terra's fortresses, ComStar—and the Word of Blake after them—made extensive use of the remaining Brians, but the technology to build a complete complex was something even they could not replicate.

Originally built as a pre-Star League buffer with the bellicose Draconis Combine, Castles Brian would eventually be built along all the Hegemony's borders and eventually on many vital internal worlds. Thirty years after the first Brian was built on Telos IV, there were already more than one hundred of the massive complexes. Unlike many weapons of war, the Castles Brian were never designed to win a battle. Instead they were the ultimate in resistance warfare. A properly prepared Castles Brian

could hold out for months or even years of hostile occupation. Able to withstand direct orbital and even nuclear attacks, the largest of the underground complexes could hold more than two brigades. While an enemy force could take a world defended by one or more Brian, the fortresses would represent an unavoidable threat and require the hostile force to maintain sufficient garrisons to deal with it. They became something akin to the twentieth century's nuclear deterrent, their very presence keeping attackers from attempting an attack.

The total number of these fortresses has never been fully determined. Over twenty existed on Terra alone and the highly skilled Hegemony engineers often managed to construct them right under the noses of their neighbors and allies; witness the famous Castle Brian that the Helm Memory Core was found in. While even the Star League's own academy training describes a typical Castles Brian (20 heavy weapon turrets, five vehicle entrances, anti-personnel turrets and so on), the reality was that no two Brians were alike, with even several classifications of the structures and other levels of fortified SLDF bases.

### CASTLES

Precursors to the heavily fortified Brian, conventional castles were built on worlds that were either extremely important or that had rebellious populations. Often built into the sides of mountains or underground beneath meters of concrete, castles were stockpiled with weapons and honeycombed with tunnels for soldiers to reach ambush points.

### CASTLES BRIAN

The most famous (or infamous depending upon your point of view) and the most awesome type of castle was the Castle Brian. The first Castles Brian were built on Hegemony border worlds to deter neighboring realms. Each could hold up to two brigades in their endless series of tunnels and BattleMech caverns. A full-size Brian could extend for hundreds of kilometers underground, forming a virtual city of its own. The Sydney complex on Terra is an extreme example of this size, literally a city under a city.

### OUTPOST CASTLES

The Star League built Outpost Castles after the Reunification War to suppress

further rebellions. The Outpost Castles were very much like Castles Brian but on a slightly smaller scale, a fact that led to the deaths of many SLDF troopers during the Amaris Coup because these gave Republic forces a thorough understanding of their larger cousins and how to defeat them.

### PORT CASTLES

Port Castles were complex creations carved out of stone. Each had a small spaceport built into a highly protected position so that the regiments within could be relieved during a fight. Few Port Castles were built because the spaceports, no matter how well defended, were vulnerable to attacks from the ground and the air. The facilities on the outskirts of the Odessa system were most likely a functioning Port Castle.

### MINI-CASTLES

Smaller version of Castles, Mini-Castles held only one regiment and had fewer exits and entrances. Mini-Castles were sometimes built around a Castle Brian to serve as its first line of defense.

### AN EXAMPLE IN MINIATURE: THE DEVILS TOWER CASTLE BRIAN

The Devils Tower complex is an excellent example of the various components of a Castle Brian, writ in compact scale. Thanks to its remote location and specific purpose, it does not sprawl like the typical fortress. By technical SLDF classification, Devils Tower would probably be rated a Mini-Castle, but it was no less difficult for the Coalition to bring the heel.

The Devils Tower facility was first constructed in the late 20th Century. Built as a secret backup site to the more famous Cheyenne Mountain Complex (a very primitive precursor to the Castle Brian), the Tower facility served as a backup site for the North American Air Defense command and emergency bunker for its governmental leadership, a part of the United States of America before it merged with the Western Alliance and its Western Alliance Armed Forces. It remained secret for well over a century, in no small part due to the well-fueled misinformation that said base was actually located inside the Mount Rushmore Monument in the nearby Black Hills. During the Terran Hegemony, the facility was reactivated and reinforced to be a major HAF and then SLDF

### CASTLES BRIAN

command operations post. (By this time, Cheyenne Mountain had been converted into a museum, replaced by the Gunnison, Colorado Castle Brian.) In the 3030's, the newly emerged Com Guards again reactivated it as a training facility, but it was not until after the Word captured Terra in 3058 that it was formally upgraded with heavy external fortifications—all carefully camouflaged to blend into the local terrain—and served as one of the Word's primary combat operation centers.

The Word's expansions to Devils Tower remained unknown to Coalition forces and it was missed in the initial efforts to isolate the planet's Castle Brian fortifications. Coalition forces pushing in from several directions allowed the Word's Precentor Martial St. Jamais to retreat towards the facility and the deadly protection its fixed emplacements and supporting Rattler-class anti-aerospace mobile fortresses provided. With the siege of the complex, St. Jamais' defeat, and the Word's eventual scuttling of the facility, organized resistance in North America ceased and Stone was able to soon declare victory over the majority of Terra. *[NOTE: As of this writing, the Word still holds portions of the Sydney and Cairo Castles*

*Brian and continues to wage a guerrilla effort against the Coalition. Several small forces, including two Wyrms SDS submersibles, also remain at large.]*

The Tower facility is over a dozen kilometers from any civilian population, with the nearby town of Devils Tower converted to an above-ground fortified base. The original 20th century complex leveraged large, excavated underground caverns beneath the towering monument. During the Terran Hegemony these were reinforced and expanded. To the two original entrances—one hidden in a barn in the nearby town and the other in a valley a kilometer to the north—was added a 12 km tunnel opening near the community of Hulett to the northeast. Three sally ports, two in the shadow of the monument and the third several kilometers to the east, were also added. The Word converted the town of Devils Tower into a fortified base, with several hardened hangars able to house a wing of aerospace fighters and supporting aerodyne DropShips. The road ringing the Tower's perimeter was studded with heavy weapon gun emplacements, anti-personnel turrets, and command-detonated minefields. The road

was reinforced and extended around the northern portion of the Tower, allowing the Rattler mobile fortresses to easily exit via the two sally ports and withdraw into the safety of the facility when counterattacked by artillery or capital weapons fire. Closer to the plateau, eight Castle Brian-grade structures supported heavy weapon and artillery turrets. These structures were capable of withstanding direct strikes by WarShip-grade weapons and all but blocked a direct approach on the main complex underneath Devils Tower. A fortified command and observation post was built atop the Tower's plateau, giving the Word defenders an unobstructed view in all directions. Heavy anti-aircraft batteries were installed around the post, preventing even the most determined aerial attack from getting close.

Had St. Jamais not foolishly chosen to face Stone on the open plains east of Devils Tower, it is likely the Coalition's eventual victory over Terra would have dragged into months and possibly years. Victory over Terra was as much the result of the failings and egos of the Word commanders as it was the combined forces of the Coalition and Devlin Stone's tenacious leadership.

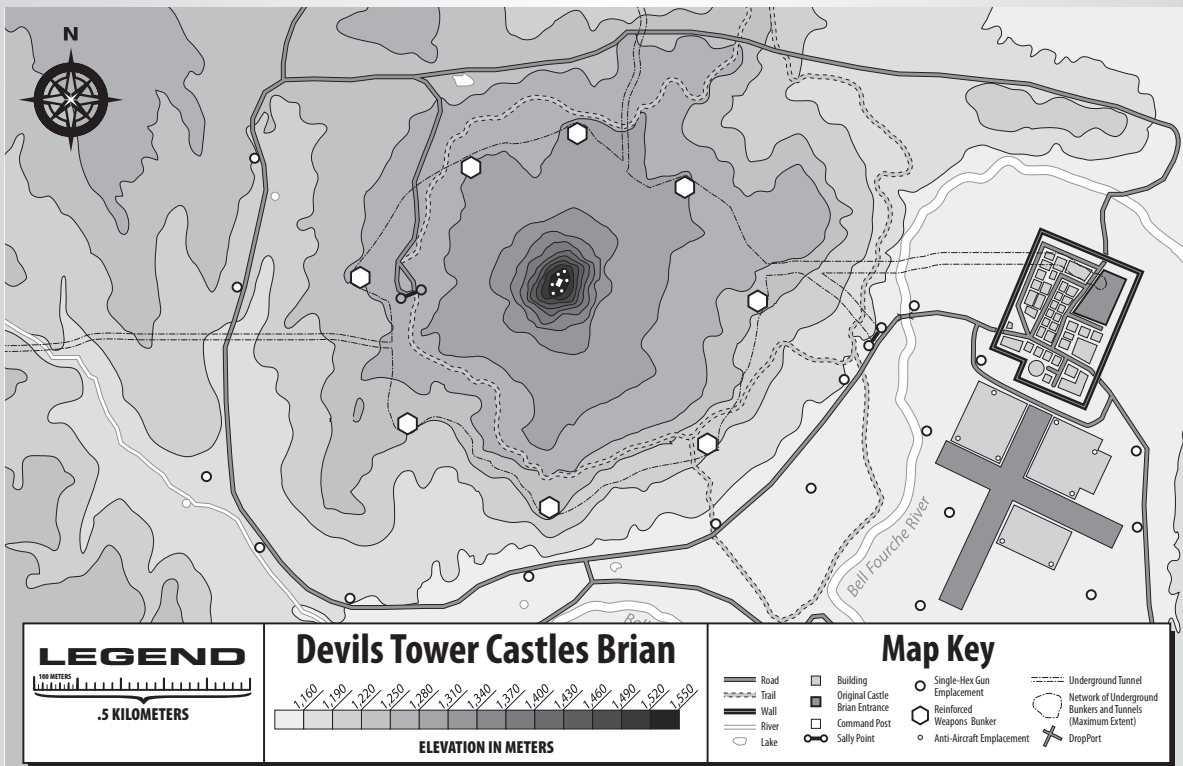



RULES ANNEX

**CASTLE BRIAN GAME RULES**

**Rules Level:** Advanced

**Note:** The following rules build on the Castle Brian Complexes rules found in *Tactical Operations* (see pp. 141-143, *TO*). They can be used in place of those rules, or can build upon those rules, based upon each playing group's desire.

As with all rules found in *Tactical Operations*, while Castles Brian add a fantastic degree of "epic scope" when dealing with truly massive invasions of a planet, that very level of detail makes their usage complex. While these rules are as comprehensive as possible, players should be aware before starting a game that they may need to make their own rulings as they interact with a Castle Brian during game play.

**UNDERGROUND COMPLEXES**

Subterranean Brian structures are typically large and intricate constructions that leverage natural rock formations and advanced engineering. The following are simple rules for representing these underground complexes without the need for specifically mapping them out (as done with the *Castle Brian Complexes* rules from *Tactical Operations*).

For game play, lay out any of the urban mapsheets or build your own urban map with counters. Streets and open areas represent the open underground areas of the Castles Brian complex. The various buildings represent the structural walls, equipment and facilities within the complex (see Castle Brian Building Type Conversion Table, at right). All 'natural' terrain (woods, rough, water) are treated as Clear terrain. All hills of any level are treated as impassable rock walls.

After laying out the maps that will be used, the players must agree on the height of the complex. Each map is determined separately. Normal heights are 1 and 2 levels, but can be as high as 6 levels with agreement from all players. Any building with a height of more than a map's designated height is treated as if it were as tall as the map (i.e. a Level 6 heavy building on a Level 1 map would be treated as a Level 1 building).

The interior height of the complex will dictate actions that can be conducted by combat units. Except where specifically noted, all standard movement and combat rules (or Advanced Rules from *Tactical Operations*, if in use) still apply:

- **1 Level:** No units may use their jump jets to move. All non-infantry movement is reduced by 1. No Large Vehicles and Quad BattleMechs may enter a hex. No VTOLs or WiGEs may be airborne in a hex. 'Mechs must use the crawling rules (see p. 20, *TO*). 'Mechs may only use arm-mounted weapons and firing while prone rules (see p. 113, *TW*). Any missile weapon with a maximum range of 13 or more hexes may not fire at any target beyond a 2-hex range and must apply a +3 to-hit modifier, in addition to any other applicable modifiers.

- **2 Levels:** No VTOLs or WiGEs may be airborne in a hex. Non-infantry units may not use their jump jets to move. Assault 'Mechs have a -1 movement modifier as a result of the low ceiling (subtract from their Walking MP; refigure Running MP as normal). Any missile weapon with a maximum range of 12 or more hexes suffers a +3 to-hit modifier at all ranges.
- **3 Levels:** VTOLs and WiGEs that move faster than their cruise speed must make a piloting roll at +3. Failure will result in an immediate crash. 'Mechs may not use their jump jets to move. Any missile weapon with a maximum range of 12 or more hexes suffers a +1 to-hit modifier at all ranges.
- **4 Levels:** VTOLs and WiGEs that move faster than their cruise speed must make a piloting roll at +1. Medium class and heavier 'Mechs may not use their jump jets to move. Light 'Mechs apply a +1 modifier to all Piloting Skill Rolls and a +1 to-hit modifier to all attacks in any turn they use jumping MPs.
- **5 Levels:** Heavy class and heavier 'Mechs may not use their jump jets to move. Medium 'Mechs apply a +1 modifier to all Piloting Skill Rolls and +1 to-hit modifier to all attacks in any turn they use jumping MPs.
- **6 Levels:** Heavy and Assault 'Mechs apply a +1 modifier to all Piloting Skill Rolls and +1 to-hit modifier in any turn they use jump MPs.
- **All Levels:** No aerospace units (including conventional fighters and Fixed-Wing Support Vehicles) may launch or land in any hex.

**CASTLES BRIAN**

**CASTLE BRIAN BUILDING TYPE CONVERSION TABLE**

<b>Tent</b>	Light equipment and storage crates
<b>Hanger (All)</b>	Treat as interior walls
<b>Standard</b>	
Light	Light equipment and storage crates
Medium	Treat as interior walls
Heavy	Internal Structures, treat as building the height of the map
<b>Fence</b>	Ignored
<b>Wall (All)</b>	Interior Wall
<b>Bridge (All)</b>	Bridge
<b>Gun Emplacement (All)</b>	Interior Defense Placement, energy weapons only
<b>Fortress (All)</b>	Internal Structure height equals map height

## RULES ANNEX

**Tunnels**

Tunnels are used to connect various underground complexes or lead to surface exits. Unless otherwise noted, tunnels are 15 meters (1/2 hex) wide and 1 Level high. A maximum of one friendly unit (two if both units are infantry units) may be in any hex at a time. Tunnels can be larger in size, most commonly 15 meters wide and 2 Levels tall, to allow for the passage of 'Mechs, but larger tunnels are relatively rare and typically for a specific purpose, such as the movement of Mobile Structures or other large units.

Any tunnel that is one hex or less in width has an effect on combat. All attacks on a unit in a narrow tunnel apply a -1 to-hit modifier due to the unit's limited mobility.

Prior to game play, all tunnels should be notated with their width and height to prevent confusion.

## USING CASTLE BRIAN STRUCTURES

The following structures represent some of the more common structure types used by Castles Brian across the Terran Hegemony and Star League bases. Players can use them to build specific scenarios, placing one or more of the structures on the playing area (see the three pages of Castles Brian Templates at the end of the book). When placing structures, any structure of three or more hexes must be connected by a tunnel to at least one other structure.

### REINFORCED WEAPONS BUNKER (RWB)

The largest regularly constructed weapons emplacement, RWBs were commonly used to protect direct approaches to the main portions of a Castle Brian or critical transit points such as passes, bridges, and bays. Sacrificing some durability for easier construction, the RWB was still a Castle Brian-classification structure and contained enough firepower to hold an entire regiment at bay under the right conditions. Designed to face a primary direction, the forward turrets were generally equipped with heavy batteries of direct fire, long range weapons such as PPCs and LRM launchers.

The interior of the building is then used to house indirect fire or capital scale defense systems. Massive batteries of Long Toms, anti-aircraft-tasked Thumpers and Arrow IV launchers are the most common conventional weapons found. The Word of Blake retrofitted many of its RWBs with large cruise missile batteries, allowing for highly accurate long range ground-to-ground fire that capital-class missile systems generally lacked. Two smaller turrets in the center of the building were dedicated to anti-aerospace defense with cluster autocannons and LRM batteries.

The exterior of an RWB was pockmarked with small weapon blisters specifically designed to protect the structure itself from assault. Ranging from Gatling gun anti-personnel weapons up to 'Mech-killer autocannons, these defense blisters made a direct assault on a RWB an undesirable prospect. Targeting lasers allowed

## DEVILS TOWER CASTLE BRIAN

Players wishing to recreate the final battle at Devils Tower can use the following guidelines for creating a scenario.

**Reinforced Weapons Bunkers:** Eight RWBs are placed roughly a kilometer out from the Devils Tower obelisk. Four are placed at the twelve, three, six and nine o'clock positions, with the remaining four spaced evenly between these.

**Command and Control Bunker:** A CNC bunker is placed on the top, center of the Devils Tower Obelisk. The top of the Obelisk measures 200 meters long by 180 meters wide at its widest.

**Anti-Aerospace Bunkers:** One AAA Bunker is placed on the top of the Devils Tower Obelisk, to the right of the CNC Bunker. Two AAA Bunkers are located to the north and south of the aerospace field, east of the town of Devils Tower.

**Gun Emplacements:** Four Gun Emplacements are placed within 250 meters of each RWB and Aerospace Hangar, placed as directly off the corners of the RWB as possible with the map being used. On the road surrounding the Tower's hill, Gun Emplacements are placed every 250 meters, alternating sides of the road. Two Gun Emplacements are placed 250 meters from front of Mobile Structure Portals. Two Gun Emplacements are located at the ends of each runway, at the aerospace field.

**Anti-Personnel Turrets:** Four AP turrets are placed within 90 meters of each Gun Emplacement. For every 150 meters of Fortified Wall, place one AP turret 60 meters from each side of the wall.

**Aerospace Hangar:** Two Aerodyne (7 Levels tall) and two aerospace (3 Levels tall) Hangars are located outside the east wall of the town of Devils Tower. A north south runway capable of supporting aerodynes and a NW/SE runway capable of supporting aerospace and small craft are located next to the hangars.

**Mobile Structure Portal:** One Portal is located at the former visitor center, just to the west of the Obelisk, facing north. One Portal is located to the east of the Tower, right where the road from the town turns to the south. A three level high Portal (otherwise identical in stats to the standard portal) is located north of the tower, just off the north edge of the map. A full size portal is located five kilometers to the west, in a nearby valley.

**Fortified Walls:** The town of Devils Tower is surrounded completely by a fortified wall structure. The North, West and East entrances use three level tall Mobile Portals as gate structures.

**Tunnels:** Tunnels connecting the RWB, CNC, AAA Bunker and Gun Emplacements to the underground Brian complex are standard tunnels (15 meters wide, 1 Level high). Tunnels connecting the Aerospace Hangar are 1 hex wide and 2 Levels high. Tunnels connecting the Mobile Structure Portals to the Brian Complex are 3 hexes wide and 7 Levels high. Portal tunnels connect to a underground Brian structure 9 hexes on a side and 10 Levels high.



**RULES ANNEX**

nearby RWBs to provide supportive fire, raining down Arrow IV homing missiles in huge volleys. These defenses, combined with a total lack of above ground entrances, meant most RWBs destroyed in combat were done with orbital or nuclear strikes.

The structures themselves were fully self-contained. Occupancy was cramped with most officers doubling up, but there was adequate food, medical, and service facilities to allow RWB crews to withstand long sieges, even if the rest of the Castles Brian had been breached or destroyed.

**Variants:** Capital-class RWBs were found defending several Terran and Terran Hegemony Brians. These replaced one or more of the artillery turrets with a Naval Laser 55 or a paired Killer Whale and Barracuda Launcher.

Some remote or isolated RWBs were more easily serviced from above ground. These would replace one of their anti-aircraft turrets (Hex 3 or 6) with a Helipad and two interior hangars, sacrificing storage and crew quarters to make space for them.

**Type:** Castle Brian Reinforced Weapons Bunker

**Technology Base:** Inner Sphere

**Building Classification:** Castle Brian

**Building Type:** Hardened

**Construction Factor (Per hex):** 100 (Capital)

**Armor (Per hex):** 150 (Capital)

**Dimensions:**

**Length:** 120 meters (4 Hexes)

**Width:** 90 meters (3 Hexes)

**Height:** 30 meters (5 Levels)

**Base Crew:** 105 Officers, 181 Crew, 350 Gunners, 112 Infantry

**Notes:** 65 Officers Quarters (10 Hex 1, 10 Hex 2, 10 Hex 4, 5 Hex 5, 10, Hex 6, 10 Hex 8, 10 Hex 10), 360 Crew Quarters (30 Hex 1, 30 Hex 2, 40 Hex 3, 60 Hex 4, 40 Hex 5, 60 Hex 6, 30 Hex 8, 40 Hex 9, 30 Hex 10). All quarters double occupancy. 40 Tons of Communication Equipment (20 Hex 4, 20 hex 6), 5 Field Kitchens (Hex 1, 2, 5, 8 and 10), 4 Infantry Compartments (2 Hex 4, 2 Hex 6), 2 M.A.S.H/10 Operating Theatres each (Hex 4 and 6), 2 Mobile Field Bases (Hex 4 and 6). 1 60 ton capacity – 2 level Industrial Elevator (Hex 7, Level 1), 2 10-ton capacity Level 2 Industrial Elevators (Hex 3, 6 Level 1).

**Hexes 1, 2, 5, 8, 9:**

**Weapons and Equipment**

- 3 ER PPC
- 3 LB 10-X AC  
Ammo (LB-X) 300
- 3 LRM 15+Artemis  
Ammo (LRM) 720
- 1 Autocannon/20

**Hex/Location**

- Turret
- Turret
- Level 5
- Turret
- Level 5
- Level 2

- Ammo (AC) 100 Level 2
- 3 SRM 6+Artemis Level 2
- Ammo (SRM) 450 Level 2
- 1 TAG Level 2
- 4 Machine Guns Level 1
- Ammo (MG) 600 Level 1
- 4 Medium Pulse Lasers Level 2
- 1 Flamer Level 1
- 4 Anti-Missile Systems Level 3
- Ammo (AMS) 120 Level 3

*Weapons Facings:* Hex 1: Facing 1; Hex 2: Facing 6; Hex 5: Facing 6; Hex 8: Facing 5; Hex 9: Facing 3

**Hexes 3, 6:**

**Weapons and Equipment**

- 3 LB 2-X AC
- Ammo (LB-X) 675
- 3 LRM 15+Artemis
- Ammo (LRM) 120

**Hex/Location**

- Turret
- Turret

**Hex 7:**

**Weapons and Equipment**

- 2 Cruise Missile/120  
Ammo (Cruise) 60
- 2 ER Large Lasers
- 4 Medium Pulse Lasers
- 3 SRM 6+Artemis  
Ammo (SRM) 450
- 4 Heavy Machine Guns  
Ammo (MG) 600
- 1 Flamer
- 4 Anti-Missile Systems  
Ammo (AMS) 120

**Hex/Location**

- Turret
- Level 5
- Level 2
- Level 2
- Level 2
- Level 2
- Level 2
- Level 3
- Level 3

*Weapons Facings:* Facing 2

**Hexes 4, 10:**

**Weapons and Equipment**

- 3 Long Toms  
Ammo (Long Tom) 300
- 3 Thumpers  
Ammo (Thumper) 300
- 3 Arrow IV Missiles  
Ammo (Arrow IV) 90
- 3 LRM 15+Artemis  
Ammo (LRM) 480
- 2 ER Large Lasers
- 4 Medium Pulse Lasers
- 3 SRM 6+Artemis  
Ammo (SRM) 450

**Hex/Location**

- Turret
- Level 5
- Turret
- Level 5
- Turret
- Level 2
- Level 2
- Level 2
- Level 2
- Level 2
- Level 2

## RULES ANNEX

4 Heavy Machine Guns	Level 1
Ammo (MG) 600	Level 1
1 Flamer	Level 1
4 Anti-Missile Systems	Level 3
Ammo (AMS) 120	Level 3

*Weapon Facing:* Hex 4: Facing 2; Hex 10: Facing 3

**Game Notes:** The RWB sits on top of a Level 2 Castles Brian of the exact same dimensions, representing the subterranean portion of the Bunker. The underground Brian structure is devoted to storage and tunnel/elevator access to other parts of the complex.

### COMMAND AND CONTROL BUNKER

While designed to allow complete operation from their sealed depths, any battlefield commander will admit there is a great difference between seeing icons on a screen to getting a first-hand look at the battlefield. Command and Control Bunkers allowed key areas to be under direct observation. Festooned with sensors, cameras, observation posts, and communications equipment to direct a system-wide offensive, these fortifications were key targets in any assault on a Castle Brian. However, the destruction of a CNC Bunker would only deprive the Brian fortress of some of its direct eyes; it would not decapitate the base.

**Type:** Castle Brian Command and Control Bunker

**Technology Base:** Inner Sphere

**Building Classification:** Castle Brian

**Building Type:** Hardened

**Construction Factor (Per hex):** 150 (Capital)

**Armor (Per hex):** 150 (Capital)

#### Dimensions:

**Length:** 90 meters (3 Hexes)

**Width:** 60 meters (2 Hexes)

**Height:** 18 meters (3 Levels)

**Base Crew:** 45 Officers, 132 Crew, 120 Gunners, 112 Infantry.

**Notes:** 45 Officers Quarters (15 Hex 1, 15 Hex 2, 15 Hex 4), 135 Crew Quarters (45 Hex 1, 45 Hex 2, 45 Hex 4). All crew quarters double occupancy. 30 Tons of Communication Equipment (Hex 3), 2 Field Kitchens (Hex 1, 4), 4 Infantry Compartments (Hex 2), 1 M.A.S.H/5 Operating Theatres (Hex 3), 1 Helipad with two VTOL cubicles (Hex 3), 1 Guardian ECM (Hex 2), 1 Beagle Active Probe (Hex 3), 1 Ground-Mobile HPG (Hex 3). 1 20-ton capacity – 2 level Industrial Elevator (Hex 3, Level 1),

#### Hexes 1, 2, 4:

##### Weapons and Equipment

3 ER PPCs

##### Hex/Location

Turret

3 LB 10-X AC	Turret
Ammo (LB-X) 300	Level 3
3 LRM 15+Artemis	Turret
Ammo (LRM) 720	Level 3
2 Arrow IV Missiles	Turret
Ammo (Arrow IV) 60	Level 3
4 SRM 6+Artemis	Level 2
Ammo (SRM) 450	Level 2
4 Machine Guns	Level 1
Ammo (MG) 600	Level 1
4 Medium Pulse Lasers	Level 2
2 Flamers	Level 1
4 Anti-Missile Systems	Level 3
Ammo (AMS) 120	Level 3
2 TAG	Level 2

*Weapons Facings:* Hex 1: Evenly between Facing 5 & 6; Hex 2: Facing 4; Hex 4: Evenly between Facing 2 and 3

#### Hex 3:

##### Weapons and Equipment

	Hex/Location
2 Large Pulse Lasers	Level 2
2 Medium Pulse Lasers	Level 2
2 SRM 6+Artemis	Level 2
Ammo (SRM) 225	Level 2
1 TAG	Level 2
4 Machine Guns	Level 2
Ammo (MG) 600	Level 2
2 Flamers	Level 2
4 Anti-Missile Systems	Level 3
Ammo (AMS) 120	Level 3

*Weapons Facings:* Hex 2: Facing 1

**Game Notes:** The CNC sits on top of a Level 2 Castles Brian of the exact same dimensions, representing the subterranean portion of the Bunker. The underground Brian structure is devoted to storage and tunnel/elevator access to other parts of the complex.

### ANTI-AEROSPACE BUNKER

Anti-Aerospace Bunkers were typically placed near other aboveground Brian facilities. These small structures were some of the most heavily constructed Brian fortifications, able to withstand sustained bombardments even while returning fire. Three turrets carry dedicated anti-air weaponry capable of downing any aerospace craft that comes in range.

Posting in an Anti-Aerospace Bunker was considered some of the least desirable duty in a Castle Brian. Despite being equipped with facilities for the entire crew, the compact structure made for extremely cramped working conditions.





**RULES ANNEX**

**Type:** Castle Brian Anti-Aerospace Bunker  
**Technology Base:** Inner Sphere  
**Building Classification:** Castle Brian  
**Building Type:** Hardened  
**Construction Factor (Per hex):** 100 (Capital)  
**Armor (Per hex):** 100 (Capital)

**Dimensions:**

**Length:** 60 meters (2 Hexes)  
**Width:** 60 meters (2 Hexes)  
**Height:** 12 meters (2 Levels)

**Base Crew:** 45 Officers, 50 Crew, 175 Gunners.

**Notes:** 45 Officers Quarters (15 Hex 1, 15 Hex 2, 15 Hex 3), 120 Crew Quarters (40 Hex 1, 40 Hex 2, 40 Hex 3). All crew quarters double occupancy. 3 Tons Communication Equipment (Hex 1), 2 Field Kitchens (Hex 1, 2), 3 Paramedic Equipment (1 per hex), 1 Guardian ECM (Hex 2), 1 20-ton capacity – 2 level Industrial Elevator (Hex 1, Level 1),

**Hexes 1, 2, 3:**

Weapons and Equipment	Hex/Location
4 Large Pulse Lasers	Turret
6 LB 10-X AC	Turret
Ammo (LB-X) 1000	Level 2
3 LRM 20+Artemis	Turret
Ammo (LRM) 360	Level 2
2 Thumpers	Turret
Ammo (Thumper) 600	Level 2
6 SRM 6+Artemis	Level 2
Ammo (SRM) 900	Level 2
1 TAG	Level 2
6 Machine Guns	Level 1
Ammo (MG) 1200	Level 1
6 Medium Pulse Lasers	Level 1
3 Flamers	Level 1
6 Anti-Missile Systems	Level 2
Ammo (AMS) 720	Level 2

*Weapons Facings:* All weapons are evenly placed on all three outward facings.

**Note:** Move all Level 1 weapons to Level 2 in Hex 1; otherwise it's identical to Hexes 2 and 3.

**Game Notes:** The AAA Bunker sits on top of a Level 2 Castles Brian of the exact same dimensions, representing the subterranean portion of the Bunker. The underground Brian structure is devoted to storage and tunnel/elevator access to other parts of the complex.

**FORTIFIED BRIAN WALL**

While Castles Brian were famous for their use of natural terrain as part of their fortifications, Mother Nature was not always cooperative. In these instances, fortified walls were needed to protect a vital open space, critical pass, or other important objective. Castle Brian fortified walls were self-contained structures, with individual sections sealed off from adjoining sections to allow the defensive bunkers within them to continue to operate.

Basic anti-personnel weapons studded the fortified walls with a central turret providing heavier defensive firepower. In comparison to fortified bunkers, wall structures were not heavily armed. Focused on area denial or impeding hostile forces, wall weapons were limited in class and use.

**Type:** Castle Brian Fortified Wall  
**Technology Base:** Inner Sphere  
**Building Classification:** Castle Brian  
**Building Type:** Hardened  
**Construction Factor (Per hex):** 150 (Capital)  
**Armor (Per hex):** 150 (Capital)

**Dimensions:**

**Length:** 150 meters (6 Hexes)  
**Width:** 30 meters (1 Hex)  
**Height:** 18 meters (3 Levels)

**Base Crew:** 10 Officers, 20 Crew, 30 Gunners.

**Notes:** 10 Officers Quarters (Hex 3), 25 Crew Quarters (Hex 3). All crew quarters double occupancy. 3 Tons Communication Equipment (Hex 3), 1 Field Kitchens (Hex 3), 1 Paramedic Equipment (Hex 3), 1 Guardian ECM (Hex 3), 1 10-ton capacity – 2 level Industrial Elevator (Hex 2, Level 1).

**Hexes 1, 2, 4, 5:**

Weapons and Equipment	Hex/Location
4 Machine Guns	Level 1
Ammo (MG) 1200	Level 1
4 Anti-Missile Systems	Level 3
Ammo (AMS) 720	Level 3

*Weapons Facings:* All weapons are evenly placed on the two outward facings.

**Game Notes:** The Wall sits on top of a Level 1 Castles Brian of the exact same dimensions, representing the subterranean portion of the Bunker. The underground Brian structure is devoted to storage and tunnel/elevator access to other parts of the Castles Brian.

## RULES ANNEX

### CASTLE BRIAN AEROSPACE HANGAR

Port Castles were the first to use the fortified Brian-class hangars. These heavily armored hangars ranged from low slung hangars, exclusively used for aerospace and small craft, to 100-meter-tall fortifications for spheroid DropShips. The most common style was a mid-size hanger capable of supporting small craft and aerodyne DropShips.

As with most Brian structures, the hanger was a self-contained environment, equipped with quarters to house support staff and defensive gunners as well as all the equipment needed to support them and perform all but the most complex repairs on the craft they sheltered.

**Variant:** Hangars supporting only aerospace fighters are 3 levels high and hangars supporting spheroid DropShips are 15 levels high but otherwise identical in construction.

**Type:** Castle Brian Aerospace Hangar

**Technology Base:** Inner Sphere

**Building Classification:** Castle Brian

**Building Type:** Heavy

**Construction Factor (Per hex):** 75 (Capital)

**Armor (Per hex):** 75 (Capital)

#### Dimensions:

**Length:** 180 meters (6 Hexes)

**Width:** 90 meters (3 Hexes)

**Height:** 42 meters (7 Levels)

**Base Crew:** 24 Officers, 160 Crew, 40 Gunners,

**Notes:** 24 Officers Quarters (6 Hex 3, 6 Hex 10, 6 Hex 14, 6 Hex 22), 100 Crew Quarters (25 Hex 3, 25 Hex 10, 25 Hex 14, 25 Hex 22). All crew quarters double occupancy. 4 Mobile Field Bases (Hex 2, 4, 21, 23), 2 Field Kitchens (Hex 3, 22), 2 M.A.S.H/2 Operating Theatres (Hex 3), 3 Paramedic Equipment (Hex 10, 14, 22), 2 200-ton capacity – 2 level Industrial Elevator (Hex 6 & 11, Level 1). 1 Large Door, 3 Hex wide, 6 Levels tall (Hex 9, 14, and 19 both outside facings).

#### Hexes 1, 4, 20, 23:

Weapons and Equipment	Hex/Location
4 Large Pulse Lasers	Level 1
4 Medium Pulse Lasers	Level 1
4 SRM 6+Artemis	Level 1
Ammo (SRM) 450	Level 1
4 Machine Guns	Level 1
Ammo (MG) 800	Level 1

**Game Notes:** The Hanger is built using Open Space Construction rules (see p. 138, *TO*). Hexes 6, 7, 8, 11, 12, 13, 16, 17, and 18 are open from Level 1 to Level 6.

The Hanger sits on top of a Level 2 Castles Brian of the exact

same dimensions, representing the subterranean portion of the Bunker. The underground Brian structure is devoted to storage and tunnel/elevator access to other parts of the complex.

### LARGE PORTAL (MOBILE STRUCTURE)

Castles Brian that were assigned Rattler-class anti-aerospace mobile fortresses required massive entrance portals to allow them to move in and out of the facility. Significantly larger than most Brian entrances, the Mobile Structure portals used a modification of the proven Castle Brian aerospace hangar to support the multi-story reinforced doors required. This allowed a Rattler to move unimpeded in and out of the Brian fortress from their secure underground bunkers.

The large doors, even with the most advanced technology, still required significant time to open and close and created a definite weakness to the complex. As a result, heavy weapons were placed in the structure to hold off any attempts to storm an open portal. Typically, gun emplacements were stationed within 250 meters of the entrance to provide additional support.

**Type:** Castle Brian Large Portal

**Technology Base:** Inner Sphere

**Building Classification:** Castle Brian

**Building Type:** Heavy

**Construction Factor (Per hex):** 100 (Capital)

**Armor (Per hex):** 100 (Capital)

#### Dimensions:

**Length:** 210 meters (7 Hexes)

**Width:** 60 meters (2 Hexes)

**Height:** 42 meters (7 Levels)

**Base Crew:** 15 Officers, 50 Crew, 40 Gunners

**Notes:** 16 Officers Quarters (8 Hex 2, 8 Hex 12), 50 Crew Quarters (25 Hex 2, 25 Hex 12). All crew quarters double occupancy. 2 Searchlights (Hex 3, 11), 3 Tons Communication Equipment (Hex 3), 2 Field Kitchens (Hex 2, 12), 2 Paramedic Equipment (Hex 2, 12), 2 Guardian ECM (Hex 3, 11), 2 20-ton capacity – 2 level Industrial Elevator (Hex 1 & 13, Level 1). 1 Large Door, 3 Hex wide, 6 Levels tall (Hex 5, 7, and 9 both outside facings).

#### Hexes 3, 11:

Weapons and Equipment	Hex/Location
2 Autocannon/20	Level 1
Ammo (AC) 400	
4 Large Pulse Lasers	Level 1
4 Medium Pulse Lasers	Level 1
4 SRM 6+Artemis	Level 1
Ammo (SRM) 450	Level 1



**RULES ANNEX**

- 4 Machine Guns Level 1
- Ammo (MG) 800 Level 1
- 4 Anti-Missile Systems Level 1
- Ammo (MG) 480 Level 1

*Weapons Facings:* All weapons are evenly placed on the two outward facings.

**Game Notes:** The Portal is built using Open Space Construction rules (see p. 138, *TO*). Hexes 5-10 are open from Level 1 to Level 6.

The Portal is always placed flat against a hill/mountain of equal or greater height. An underground, open space construction Castles Brian connects to the backside of the Portal, representing the interior tunnel. For every five hexes of 'tunnel' the middle hex is equipped with the identical equipment as Hex 3 of the Portal and the hex directly behind it is identical to Hex 2 of the Portal.

**CASTLE BRIAN WEAPON EMPLACEMENTS**

Gun emplacements and automated anti-personnel turrets were the most common visual representation of a Castle Brian, a small irony given that neither structure was built using the advanced construction techniques that make Brian structures so durable. Standard fortified buildings, the two turreted structures were used in large numbers, protecting other Brian structures, vital approaches and locations. Easily constructed, these semi-isolated structures were cramped and only designed for short-term duty rotations. Able to be fully sealed off from the Brian structures they were connected to, these served as disposable defenses for the greater structures.

The large gun emplacements contained the firepower of a heavy or assault BattleMech but typically made up for this with overlapping fields of supporting fire and the ability to call on artillery support from their parent Brian fortress.

The automated AP turrets carried minimal weapons and served only to provide anti-infantry defense to gun emplacements and other structures. The turret-mounted quad machine guns provided excellent anti-infantry support and the two flamers defended the structure from direct attack. Fully automated, these small turret structures could dot a hillside, making any covert approach all but impossible. The structures were also small enough that they could be built on top of an industrial elevator system that allowed them to be withdrawn underground, protecting them from heavier weapons fire.

**Type:** Gun Emplacement  
**Technology Base:** Inner Sphere  
**Building Classification:** Gun Emplacement  
**Building Type:** Hardened  
**Construction Factor (Per hex):** 150  
**Armor (Per hex):** 150

**Dimensions:**

- Length:** 30 meters (1 Hex)
- Width:** 30 meters (1 Hex)
- Height:** 12 meters (2 Levels)

**Base Crew:** 3 Officers, 5 Crew, 10 Gunners

**Notes:** 1 Crew Quarters, 7 Crew Quarters. All quarters double occupancy. 6 Searchlights (1 per facing), 1 Ton Communication Equipment, 1 Paramedic Equipment, 1 Guardian ECM.

**Weapons and Equipment**

Weapons and Equipment	Hex/Location
1 Gauss Rifle	Turret
Ammo (Gauss) 56	Level 2
1 LB 10-X Autocannon	Turret
Ammo (LB-X) 40	Level 2
1 LRM 10+Artemis	Turret
Ammo (LRM) 48	Level 2
6 Medium Pulse Lasers	Level 2 (1 per facing)
6 Machine Guns	Level 1 (1 per facing)
Ammo (MG) 800	Level 1
6 Anti-Missile Systems	Level 2 (1 per facing)
Ammo (MG) 800	Level 2

**Type:** Automated Anti-Personnel Turret  
**Technology Base:** Inner Sphere  
**Building Classification:** Gun Emplacement  
**Building Type:** Hardened  
**Construction Factor (Per hex):** 100  
**Armor (Per hex):** 100

**Dimensions:**

- Length:** 30 meters (1 Hex)
- Width:** 30 meters (1 Hex)
- Height:** 6 meters (1 Level)

**Base Crew:** None

**Notes:** 6 Searchlights (1 per facing). Equipped with Automated Weapons System (see p. 133, *TO*)

**Weapons and Equipment**

Weapons and Equipment	Hex/Location
4 Machine Guns	Turret
Ammo (MG) 400	Level 1
2 Flamers	Level 1 (Facing 1, 3)

# BATTLETECH™

## ARMOR DIAGRAM

### WARSHIP RECORD SHEET

Nose Damage Threshold  
(Total Armor)  
3 (28)

Capital Scale



#### WARSHIP DATA

Type: **NAGA CASPAR II CONTROL SHIP**

Name: \_\_\_\_\_ Tonnage: 540,000  
 Thrust: \_\_\_\_\_ Tech Base: Inner Sphere  
 Safe Thrust: 2 (Experimental)  
 Maximum Thrust: 3 Jihad  
 DropShip Capacity: 0  
 Fighters/Small Craft: 36 / 6 Launch Rate: 9

#### Weapons & Equipment Inventory

Capital Scale						
Bay	Loc	Ht	SRV	MRV	LRV	ERV
3 NAC/10 (45 mds)	N	90	30	30	30	—
3 Sub-Capital Laser/1	N	72	3	3	3	—
1 Screen Launcher (20 screens)	N	10	—	—	—	—
2 NAC/10 (40 mds)	FL/FR	60	20	20	20	—
3 Sub-Capital Laser/2	FL/FR	84	6	6	6	—
1 White Shark (20 misl)	FL/FR	15	6	6	6	6
2 NAC/10 (40 mds)	L/RBS	60	20	20	20	—
3 NL35	L/RBS	156	11	11	11	—
2 Light N-PPC	L/RBS	210	14	14	14	—
6 Sub-Capital Laser/3	L/RBS	192	18	18	18	—
1 Screen Launcher (10 screens)	L/RBS	10	—	—	—	—
3 NL35	AL/AR	156	11	11	11	—
2 Light N-PPC	AL/AR	210	14	14	14	—
1 Barracuda (10 misl)	A	10	2	2	2	2
6 Sub-Capital Laser/1	A	144	6	6	6	—
1 Screen Launcher (20 screens)	A	10	—	—	—	—
Standard Scale						
Bay	Loc	Ht	SRV	MRV	LRV	ERV
4 Large VSP Laser	N	40	4(44)	4(36)	—	—
4 MML-9 + Artemis IV (208/176 mds)	N	20	6(56)	3(28)	3(28)	—
2 AMS (72 mds)	N	2	1(12)	—	Point Defense	—
4 Large VSP Laser	FL/FR	40	4(44)	4(36)	—	—
4 MML-9 + Artemis IV (208/176 mds)	FL/FR	20	6(56)	3(28)	3(28)	—
4 Large VSP Laser	L/RBS	40	4(44)	4(36)	—	—
4 MML-9 + Artemis IV (208/176 mds)	L/RBS	20	6(56)	3(28)	3(28)	—
2 AMS (72 mds)	L/RBS	2	1(12)	—	Point Defense	—
4 Large VSP Laser	AL/AR	40	4(44)	4(36)	—	—
4 MML-9 + Artemis IV (208/176 mds)	AL/AR	20	6(56)	3(28)	3(28)	—
4 Large VSP Laser	A	40	4(44)	4(36)	—	—
4 MML-9 + Artemis IV (208/176 mds)	A	20	6(56)	3(28)	3(28)	—
2 AMS (72 mds)	A	2	1(12)	—	Point Defense	—
<b>Grav Decks:</b> Grav Deck #1: 55-meter						
<b>Cargo:</b> Bay 1: Fighters (ARTS) (36) (3 doors) Bay 2: Small Craft (6) (3 doors) Bay 3: Standard Pressurised Repair Bay (3) (75,000 ton capacity, ea) (3 doors) Bay 4: Standard Pressurised Repair Bay (6) (7,500 ton capacity, ea) (6 doors) Bay 5: Cargo (80,817 Tons) (1 door)						
<b>Notes:</b> Mobile HPG, DTACS Control System (up to 36 Caspar II drones), and Naval Comm-Scanner Suite (Large)						
<b>Ammo:</b> NAC/10 (205) Barracuda (10) White Shark (40) Screen (40) MML-9 (1,664/1,408) AMS (264)						

BV: 35,397

Fore-Left Damage Threshold (Total Armor)  
4 (32)

Fore-Right Damage Threshold (Total Armor)  
4 (32)

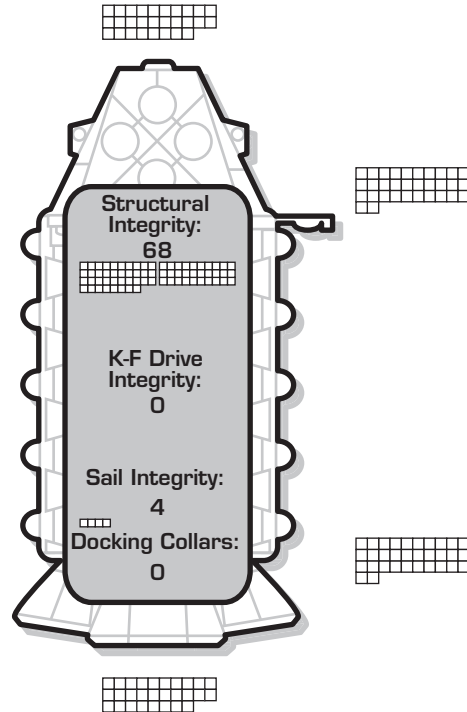

Aft-Left Damage Threshold (Total Armor)  
4 (32)

Aft-Right Damage Threshold (Total Armor)  
4 (32)

Aft Damage Threshold (Total Armor)  
3 (28)

#### CREW DATA

Gunnery Skill: \_\_\_\_\_ Piloting Skill: \_\_\_\_\_

Hits Taken	1	2	3	4	5	6
Modifier	+1	+2	+3	+4	+5	Incp.

Crew: 356 Marines: 0  
 Passengers: 0 Elementals: 0  
 Other: 114 Battle Armor: 36  
 Life Boats/Escape Pods: 22/10

#### CRITICAL DAMAGE

Avionics	+1	+2	+5	Life Support	+2
CIC	+2	+4	D		
Sensors	+1	+2	+5		
Thrusters					
Left	+1	+2	+3	D	
Right	+1	+2	+3	D	
Engine	-1	-2	-3	-4	-5

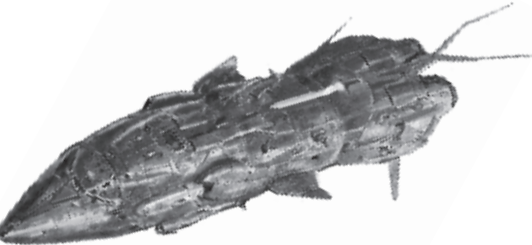

#### VELOCITY RECORD

Turn #	1	2	3	4	5	6	7	8	9	10
Thrust										
Velocity										
Effective Velocity										
Turn #	11	12	13	14	15	16	17	18	19	20
Thrust										
Velocity										
Effective Velocity										

#### HEAT DATA

Heat Sinks: 1,300 Heat Generation Per Arc: 242

Nose: 242  
 Left/Right Fore: 219 / 219  
 Left/Right Broadside: 678 / 678  
 Left/Right Aft: 510 / 510  
 Aft: 214

# BATTLETECH

Nose Damage Threshold (Total Armor) 44 (438)

## ARMOR DIAGRAM

Standard Scale



## AERODYNE DROPSHIP RECORD SHEET

### DROPSHIP DATA

Type: DRAGAU CLASS ASSAULT DROPSHIP

Name: \_\_\_\_\_ Tonnage: 2,500  
 Thrust: \_\_\_\_\_ Tech Base: Inner Sphere  
 Safe Thrust: 9 (Experimental)  
 Maximum Thrust: 14 Jihad  
 Fighters/Small Craft: 0 / 0 Launch Rate: 0

### Weapons & Equipment Inventory

Standard Scale			(1-6)	(7-12)	(13-20)	(21-25)
Bay	Loc	Ht	SRV	MRV	LRV	ERV
2 Heavy Gauss (36 rnds)	N	4	5 (50)	5 (50)	5 (50)	—
3 Heavy PPC	N	45	5 (45)	5 (45)	—	—
3 Heavy PPC	N	45	5 (45)	5 (45)	—	—
4 AMS (48 rnds)	N	4	1 (12)	Point Defense		—
2 LRM 15 + Artemis IV (56 rnds)	L/RW	10	4 (36)	4 (36)	4 (36)	—
2 ER PPC	L/RW	30	2 (20)	2 (20)	2 (20)	—
2 Large VSP	L/RW	20	2 (22)	2 (18)	—	—
2 Large VSP	L/RWA	20	2 (22)	2 (18)	—	—
2 Large VSP	A	20	2 (22)	2 (18)	—	—
3 AMS (72 rnds)	A	3	3 (9)	Point Defense		—

Notes:  
 CASPAR II Advanced Smart Robotic Control System (Gunnery 4, Piloting 5)

BV: 14,358

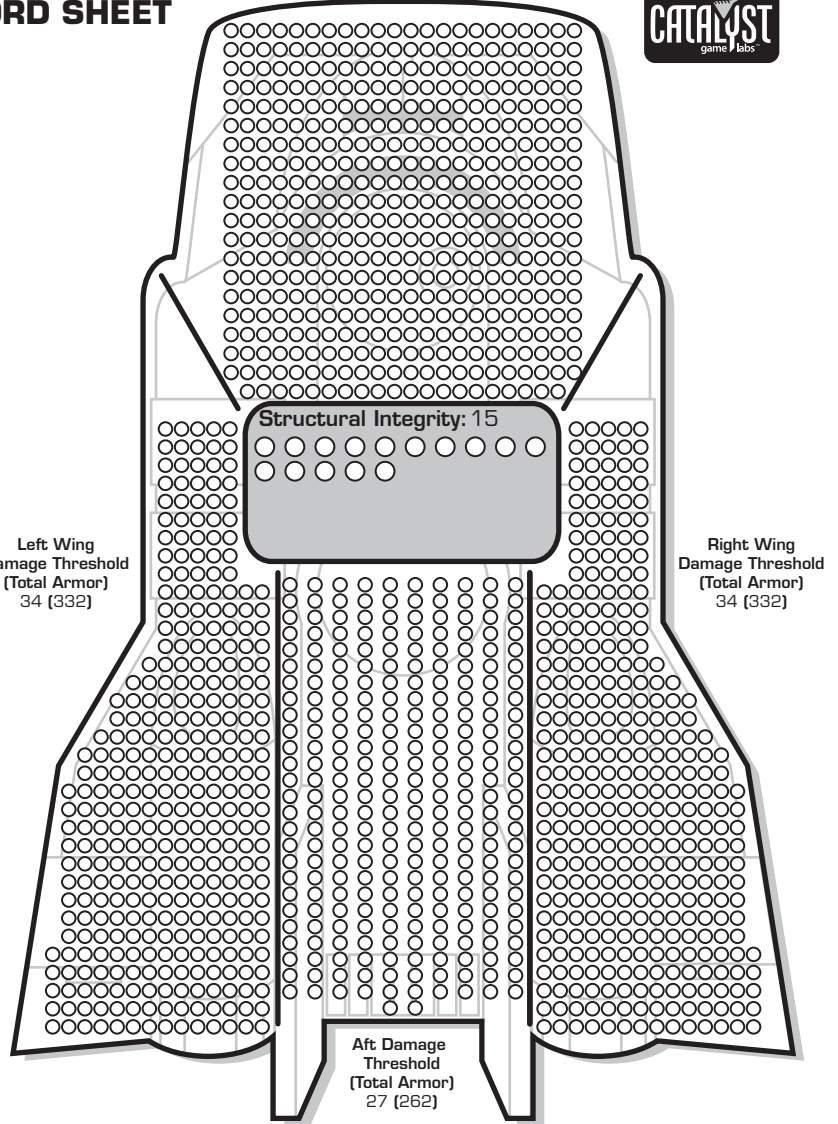

### CREW DATA

Gunnery Skill: 4 Piloting Skill: 5

Hits Taken	1	2	3	4	5	6
Modifier	+1	+2	+3	+4	+5	Incp.

Crew: 0 Marines: 0  
 Passengers: 0 Elementals: 0  
 Other: 0 Battle Armor: 0  
 Life Boats/Escape Pods: 0 / 0

### CRITICAL DAMAGE

Avionics	+1	+2	+5	Gear	+5	
FCS	+2	+4	D	Life Support	+2	
Sensors	+1	+2	+5	K-F Boom	D	
Thrusters				Docking Collar	D	
Left	+1	+2	+3	D		
Right	+1	+2	+3	D		
Engine	-1	-2	-3	-4	-5	D

### VELOCITY RECORD

Turn #	1	2	3	4	5	6	7	8	9	10
Thrust										
Velocity										
Effective Velocity										
Altitude										
Turn #	11	12	13	14	15	16	17	18	19	20
Thrust										
Velocity										
Effective Velocity										
Altitude										

### HEAT DATA

Heat Sinks:	Heat Generation Per Arc	
120 (240)	Nose: 94	Aft: 20
Double	Left Wing: 60	Right Wing: 60
	Fwd: 60	Fwd: 60
	Aft: 20	Aft: 20

# BATTLETECH

Nose Damage Threshold (Total Armor) 81 (810)

## ARMOR DIAGRAM

Standard Scale



## SPHEROID DROPSHIP RECORD SHEET

### DROPSHIP DATA

Type: TIAMAT POCKET WARSHIP CASPAR II

Name: \_\_\_\_\_ Tonnage: 36,000  
 Thrust: \_\_\_\_\_ Tech Base: Inner Sphere (Experimental) Jihad  
 Safe Thrust: 5  
 Maximum Thrust: 8  
 Fighters/Small Craft: 6 / 0 Launch Rate: 6

### Weapons & Equipment Inventory

Capital Scale		[1-12] [13-24] [25-40] [41-50]				
Bay	Loc	Ht	SRV	MRV	LRV	ERV
6 Sub-Capital Laser/3	N	193	12	12	—	—
3 Heavy Sub-Capital Cannon (60 rmds)	N	126	21	21	—	—
3 Sub-Capital Laser/3	FL/FR	96	9	9	—	—
1 Piranha Missile (15 misl)	AL/AR	9	3	3	3	—

Standard Scale		[1-6] [7-12] [13-20] [21-25]				
Bay	Loc	Ht	SRV	MRV	LRV	ERV
4 Heavy Gauss Rifle (80 rmds)	N	8	10 (100)	10 (100)	10 (100)	—
4 ER PPC	N	60	4(40)	4(40)	4(40)	—
4 Laser AMS	N	28	1(12)	Point Defense	—	—
6 Heavy PPC	FL/FR	90	15 (150)	15 (150)	15 (150)	—
4 Laser AMS	FL/FR	28	1(12)	Point Defense	—	—
6 Large VSP Laser	AL/AR	60	7(66)	5(54)	—	—
4 Laser AMS	AL/AR	28	1(12)	Point Defense	—	—
6 Large VSP Laser	A	60	7(66)	5(54)	—	—
4 Laser AMS	A	28	1(12)	Point Defense	—	—
1 Screen Launcher (20 Screens)	A	10	—	—	—	—

Notes: CASPAR II Advanced Smart Robotic Control System (Gunnery 4, Piloting 5)

Cargo: Bay 1: Fighters (ARTS) (6) (6 doors)  
 Bay 2: Cargo (143 Tons) (1 door)

BV: 47,813

Left Damage Threshold (Total Armor) 75 (750)

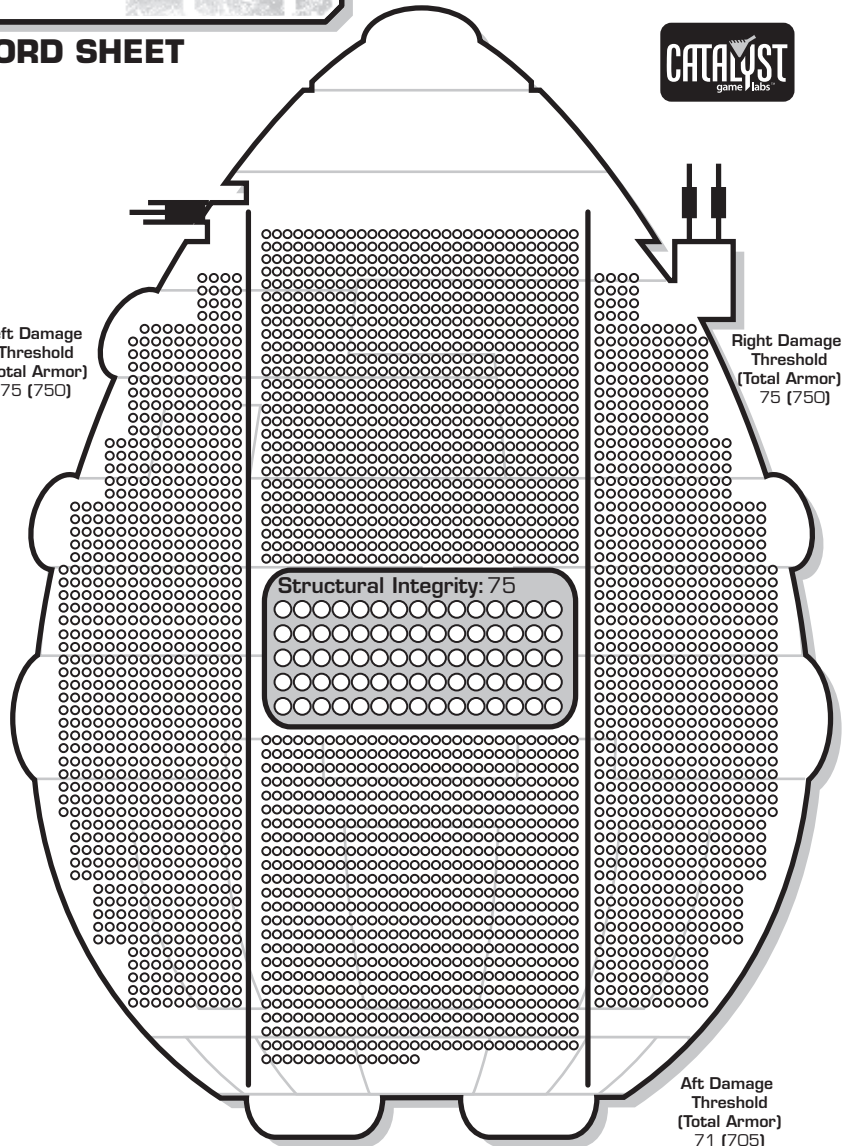

Right Damage Threshold (Total Armor) 75 (750)

Aft Damage Threshold (Total Armor) 71 (705)

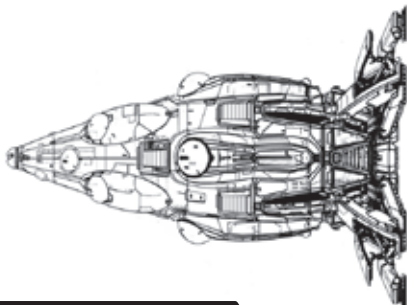

### CREW DATA

Gunnery Skill: 4    Piloting Skill: 5

Hits Taken	1	2	3	4	5	6
Modifier	+1	+2	+3	+4	+5	Incp.

Crew: 0    Marines: 0  
 Passengers: 0    Elementals: 0  
 Other: 0    Battle Armor: 0  
 Life Boats/Escape Pods: 0 / 0

### CRITICAL DAMAGE

Avionics	+1	+2	+5	Gear	+5	
FCS	+2	+4	D	Life Support	+2	
Sensors	+1	+2	+5	K-F Boom	D	
Thrusters				Docking Collar	D	
Left	+1	+2	+3	D		
Right	+1	+2	+3	D		
Engine	-1	-2	-3	-4	-5	D

### HEAT DATA

Heat Sinks: 415 (830) Double

Heat Generation Per Arc

Nose:	446	Aft:	60
Fore-Left:	246	Aft-Left:	69
Fore-Right:	246	Aft-Right:	69

### VELOCITY RECORD

Turn #	1	2	3	4	5	6	7	8	9	10
Thrust										
Velocity										
Effective Velocity										
Altitude										
Turn #	11	12	13	14	15	16	17	18	19	20
Thrust										
Velocity										
Effective Velocity										
Altitude										

# BATTLETECH™

## ARMOR DIAGRAM

Capital Scale



## SPACE STATION RECORD SHEET

### SPACE STATION DATA

Type: **DRAKE SDS CONTROL STATION**

Name: \_\_\_\_\_ Tonnage: 12,000  
 Thrust: \_\_\_\_\_ Tech Base: Inner Sphere  
 Station Keeping Only (Experimental)  
 Jihad

DropShip Capacity: 0

Fighters/Small Craft: 0 / 4 Launch Rate: 4/turn

### Weapons & Equipment Inventory

Capital Scale		(1-12)	(13-24)	(25-40)	(41-50)	
Bay	Loc	Ht	SRV	MRV	LRV	ERV
1 Swordfish Missile (20 misl)	N	15	4	—	—	—
1 Screen Launcher (20 rnds)	N	10	—	—	—	—
1 Screen Launcher (10 rnds)	AL/AR	10	—	—	—	—

Standard Scale		(1-6)	(7-12)	(13-20)	(21-25)	
Bay	Loc	Ht	SRV	MRV	LRV	ERV
2 ER Large Laser	N	24	2(16)	2(16)	2(16)	—
2 MML 9+Artemis (78/66 rnds)	N	10	6(56)	3(28)	3(28)	—
6 Med. Pusle Laser	N	24	4(36)	—	—	—
2 AMS	N	2	1(6)	Point Defense	—	—
2 ER Large Laser	FL/FR	24	2(16)	2(16)	2(16)	—
2 MML 9+Artemis (78/66 rnds)	FL/FR	10	6(56)	3(28)	3(28)	—
6 Med. Pusle Laser	FL/FR	24	4(36)	—	—	—
2 ER Large Laser	AL/AR	24	2(16)	2(16)	2(16)	—
2 MML 9+Artemis (78/66 rnds)	AL/AR	10	6(56)	3(28)	3(28)	—
6 Med. Pusle Laser	AL/AR	24	4(36)	—	—	—
2 ER Large Laser	A	24	2(16)	2(16)	2(16)	—
2 MML 9+Artemis (78/66 rnds)	A	10	6(56)	3(28)	3(28)	—
6 Med. Pusle Laser	A	24	4(36)	—	—	—
2 AMS	A	2	1(6)	Point Defense	—	—

Grav Decks: Grav Deck #1: 600-meter

Cargo: Bay 1: Unpressurised Repair Bay (5,000 tons) (4 doors)  
 Bay 2: Small Craft (4) (2 door)  
 Bay 3: Cargo (3,820.5 tons) (2 doors)

Ammo: Swordfish (20), MML 9 (624/528)  
 Screen (40), AMS (96)

BV: 3,533

Fore-Left Damage Threshold (Total Armor) 18 (180)

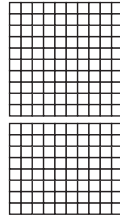

Nose Damage Threshold (Total Armor) 18 (180)

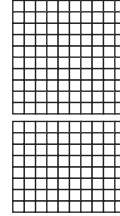

Fore-Right Damage Threshold (Total Armor) 18 (180)

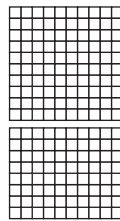
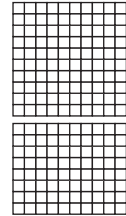

Aft-Left Damage Threshold (Total Armor) 18 (180)

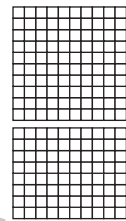

Aft-Right Damage Threshold (Total Armor) 18 (180)

Aft Damage Threshold (Total Armor) 18 (180)

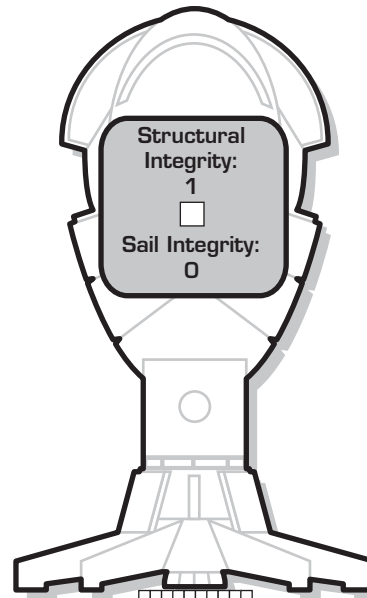

### CREW DATA

Gunnery Skill: \_\_\_\_\_ Piloting Skill: \_\_\_\_\_

Hits Taken	1	2	3	4	5	6
Modifier	+1	+2	+3	+4	+5	Incp.

Crew: 96 Marines: 0  
 Passengers: 0 Elementals: 0  
 Other: 32 Battle Armor: 12  
 Life Boats/Escape Pods: 15 / 0

### CRITICAL DAMAGE

Avionics	+1	+2	+5	Life Support	+2
CIC	+2	+4	D		
Sensors	+1	+2	+5		
Thrusters					
Left	+1	+2	+3	D	
Right	+1	+2	+3	D	

### HEAT DATA

Heat Sinks:	Heat Generation Per Arc
120 (240)	Nose: 73
Double	Left/Right Fore: 58 / 58
	Left/Right Aft: 58 / 58
	Aft: 58

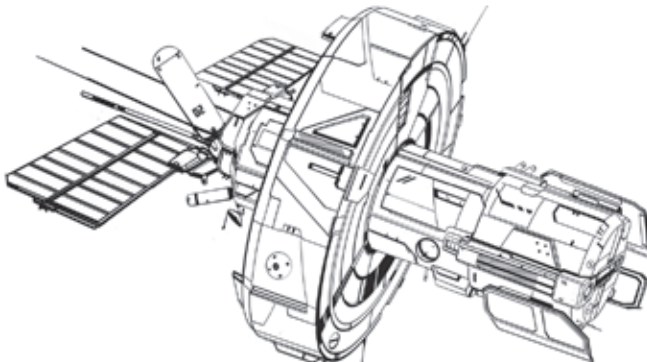

# BATTLETECH

Nose Damage Threshold (Total Armor) 23 (221)

## ARMOR DIAGRAM

Standard Scale



## SPHEROID DROPSHIP RECORD SHEET

### DROPSHIP DATA

Type: COCKATRICE MONITOR PLATFORM DRONE

Name: \_\_\_\_\_ Tonnage: 800  
 Thrust: \_\_\_\_\_ Tech Base: Inner Sphere  
 Safe Thrust: 1 (Experimental)  
 Maximum Thrust: 2 Jihad  
 Fighters/Small Craft: 0 / 0 Launch Rate: 0

### Weapons & Equipment Inventory

Capital Scale		(1-12) (13-24) (25-40) (41-50)				
Bay	Loc	Ht	SRV	MRV	LRV	ERV
1 Piranha Missile (15 misl)	N	9	3	3	3	—
Standard Scale		(1-6) (7-12) (13-20) (21-25)				
Bay	Loc	Ht	SRV	MRV	LRV	ERV
2 Large Pulse Laser	N	20	2(20)	2(20)	—	—
2 LRM 20+Artemis (36 rnds)	N	12	3(32)	3(32)	3(32)	—
1 Light Gauss Rifle (32 rnds)	N	1	1(8)	1(8)	1(8)	1(8)
1 Laser AMS	N	7	0(3)	Point Defense	—	—
2 Large Pulse Laser	FL/FR	20	2(20)	2(20)	—	—
1 Light Gauss Rifle (32 rnds)	FL/FR	1	1(8)	1(8)	1(8)	1(8)
1 Laser AMS	FL/FR	7	0(3)	Point Defense	—	—
2 Large Pulse Laser	AL/AR	20	2(20)	2(20)	—	—
1 Laser AMS	AL/AR	7	0(3)	Point Defense	—	—
2 Large Pulse Laser	A	20	2(20)	2(20)	—	—
1 ER Large Laser	A	12	1(8)	1(8)	1(8)	—

Notes:  
 Equipped with an improved Caspar II Advanced Smart Robotic Control System (Gunnery 3, Piloting 4)

Cargo:  
 None

BV: 4,428

Left Damage Threshold (Total Armor) 23 (221)

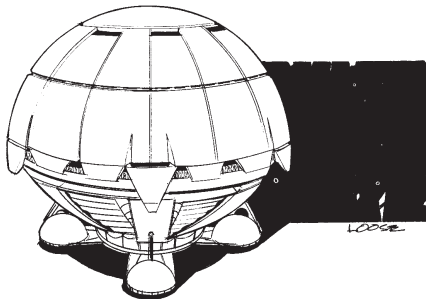
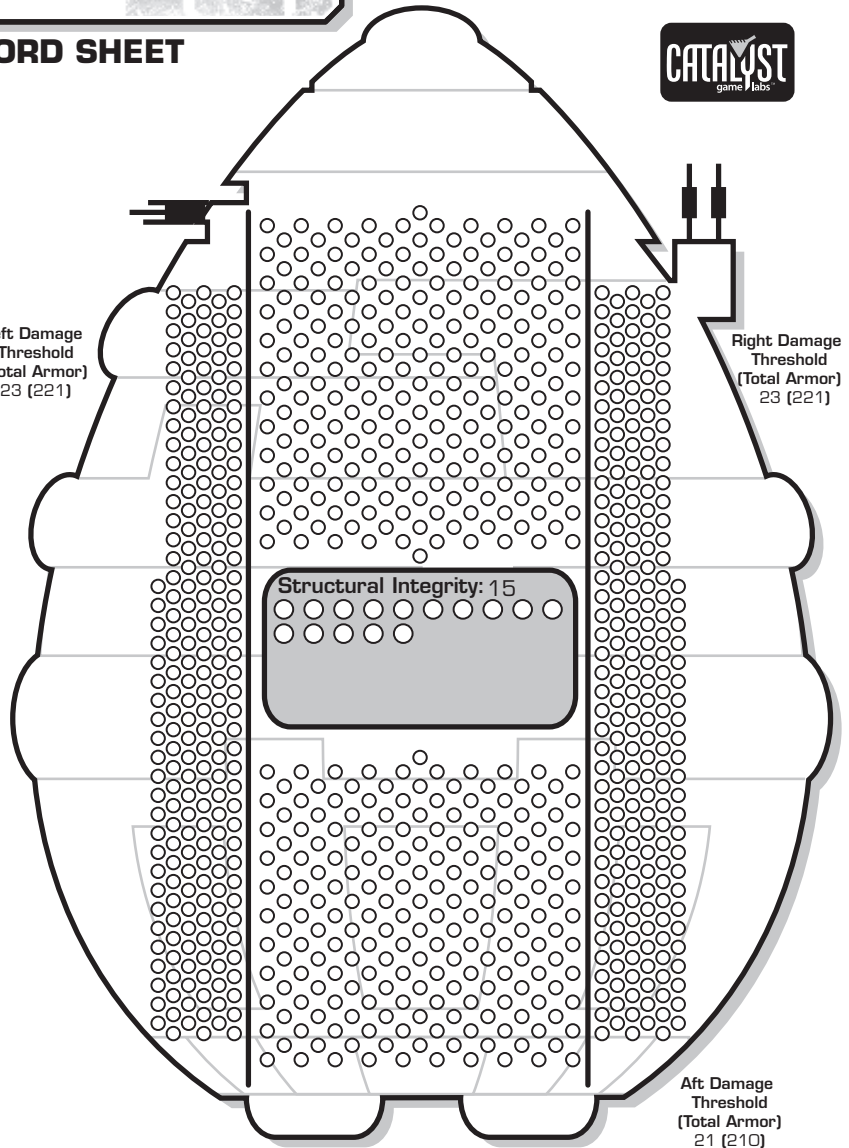

### CREW DATA

Gunnery Skill: 3 Piloting Skill: 4

Hits Taken	1	2	3	4	5	6
Modifier	+1	+2	+3	+4	+5	Incp.
Crew:	0	Marines:	0			
Passengers:	0	Elementals:	0			
Other:	0	Battle Armor:	0			
Life Boats/Escapes Pods: 0 / 0						

### CRITICAL DAMAGE

Avionics	+1	+2	+5	Gear	+5	
FCS	+2	+4	D	Life Support	+2	
Sensors	+1	+2	+5	K-F Boom	D	
Thrusters					Docking Collar	D
Left	+1	+2	+3	D		
Right	+1	+2	+3	D		
Engine	-1	-2	-3	-4	-5	D

### HEAT DATA

Heat Sinks:	Heat Generation Per Arc	
68 (136) Double	Nose: 42	Aft: 32
	Fore-Left: 21	Aft-Left: 20
	Fore-Right: 21	Aft-Right: 20

### VELOCITY RECORD

Turn #	1	2	3	4	5	6	7	8	9	10
Thrust										
Velocity										
Effective Velocity										
Altitude										
Turn #	11	12	13	14	15	16	17	18	19	20
Thrust										
Velocity										
Effective Velocity										
Altitude										



# BATTLETECH™

## AEROSPACE FIGHTER RECORD SHEET

### FIGHTER DATA

Type: **TABANID LIGHT DRONE FIGHTER**

Thrust: \_\_\_\_\_ Tonnage: 35  
 Safe Thrust: 10 Tech Base: Inner Sphere (Advanced)  
 Maximum Thrust: 15 Jihad

### Weapons & Equipment Inventory

Qty	Type	Loc	Ht	SRV	MRV	LRV	ERV
1	ER Large Laser [DE]	N	12	8	8	8	—
1	Beagle Active Probe [E]	N	—	—	—	—	—

Notes: Aerospace Smart Robotic Control System (Improved)

Fuel: 480 Points

BV: 956



### ARMOR DIAGRAM

Nose Damage Threshold (Total Armor)  
6 (52)

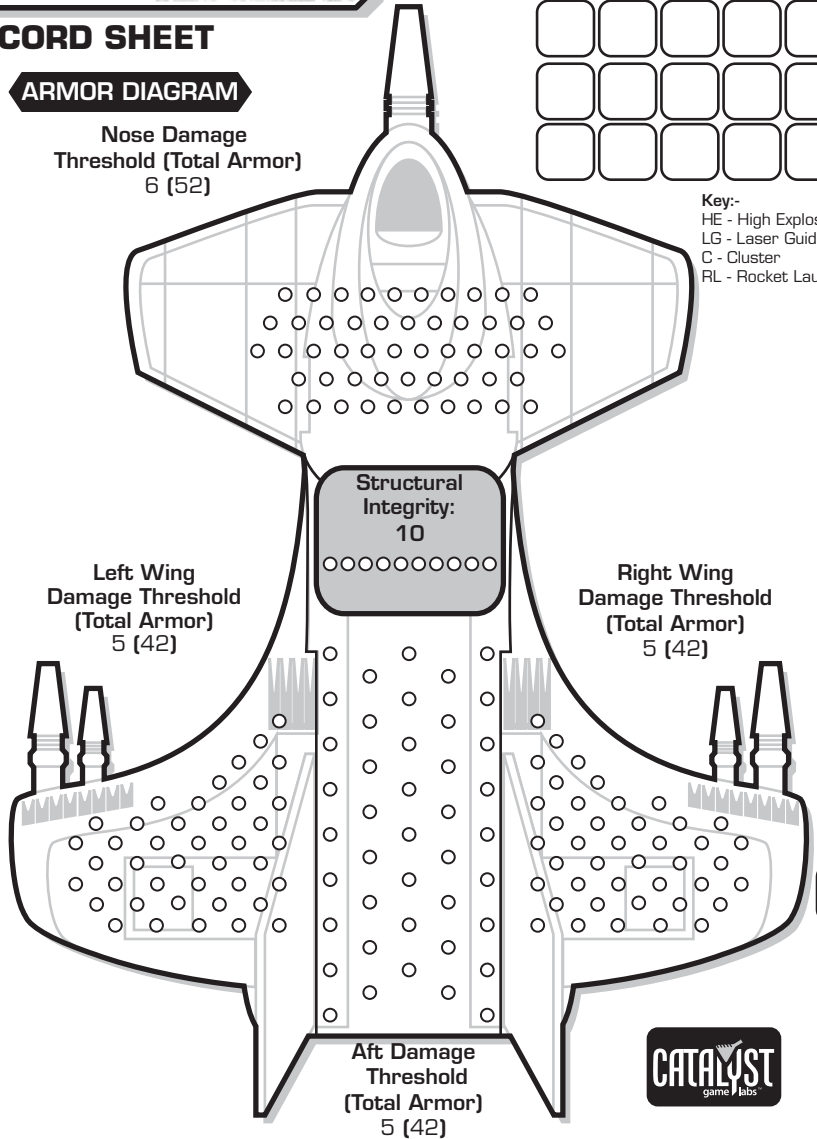

### EXTERNAL STORES/BOMBS

Key:-  
 HE - High Explosive  
 LG - Laser Guided  
 C - Cluster  
 RL - Rocket Launcher

### Heat Scale

Overflow

30*
29
28*
27*
26*
25*
24*
23*
22*
21*
20*
19*
18*
17*
16
15*
14*
13*
12
11
10*
9
8*
7
6
5*
4
3
2
1
0

### CRITICAL DAMAGE

Avionics	+1	+2	+5	Engine	2	4	D
FCS	+2	+4	D	Gear	+5		
Sensors	+1	+2	+5	Life Support	+2		

### PILOT DATA

Name: \_\_\_\_\_  
 Gunnery Skill: \_\_\_\_\_ Piloting Skill: \_\_\_\_\_

Hits Taken	1	2	3	4	5	6
Consciousness #	3	5	7	10	11	Dead
Modifier	+1	+2	+3	+4	+5	

### HEAT DATA

Heat Level*	Effects	Heat Sinks: 10 (20) Double
30	Shutdown	
28	Ammo Exp. avoid on 8+	
27	Pilot Damage, avoid on 9+	
26	Shutdown, avoid on 10+	
25	Random Movement, avoid on 10+	
24	+4 Modifier to Fire	
23	Ammo Exp. avoid on 6+	
22	Shutdown, avoid on 8+	
21	Pilot Damage, avoid on 6+	
20	Random Movement, avoid on 8+	
19	Ammo, Exp. avoid on 4+	
18	Shutdown, avoid on 6+	
17	+3 Modifier to Fire	
15	Random Movement, avoid on 7+	
14	Shutdown, avoid on 4+	
13	+2 Modifier to Fire	
10	Random Movement, avoid on 6+	
8	+1 Modifier to Fire	
5	Random Movement, avoid on 5+	

### VELOCITY RECORD

Turn #	1	2	3	4	5	6	7	8	9	10
Thrust										
Velocity										
Effective Velocity										
Altitude										
Turn #	11	12	13	14	15	16	17	18	19	20
Thrust										
Velocity										
Effective Velocity										
Altitude										

# BATTLETECH™

## AEROSPACE FIGHTER RECORD SHEET

### FIGHTER DATA

Type: SCARAB MEDIUM DRONE FIGHTER

Thrust: Tonnage: 70  
 Safe Thrust: 7 Tech Base: Inner Sphere  
 Maximum Thrust: 11 (Advanced)  
Jihad

### Weapons & Equipment Inventory

Qty	Type	Loc	Ht	SRV	MRV	LRV	ERV
2	Medium VSP Laser [P,V,AI]	N	7	7	—	—	—
1	Guardian ECM Suite [E]	N	—	—	—	—	—
1	Large Pulse Laser [P]	L/RW	10	9	9	—	—

Notes: Aerospace Smart Robotic Control System (Improved)

Fuel: 480 Points

BV: 1,364

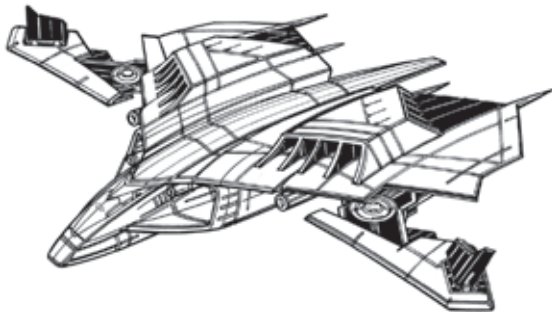

### ARMOR DIAGRAM

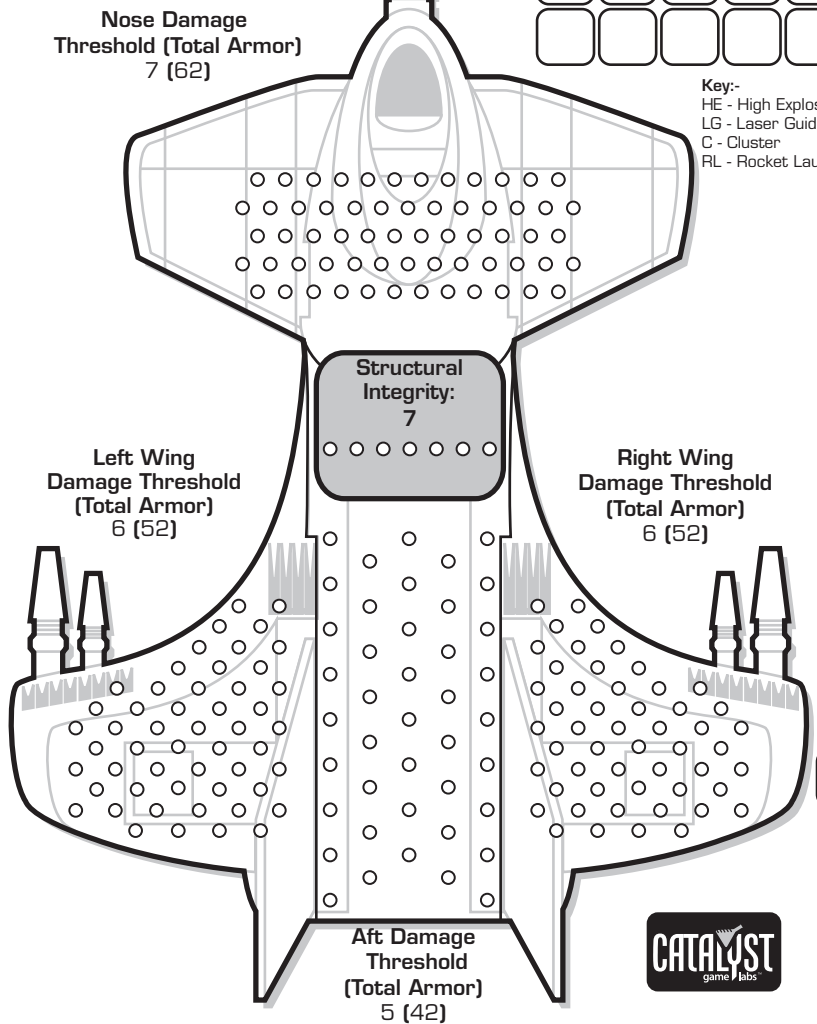

### EXTERNAL STORES/BOMBS

Key:-  
 HE - High Explosive  
 LG - Laser Guided  
 C - Cluster  
 RL - Rocket Launcher

### Heat Scale

Overflow

30*
29
28*
27*
26*
25*
24*
23*
22*
21*
20*
19*
18*
17*
16
15*
14*
13*
12
11
10*
9
8*
7
6
5*
4
3
2
1
0

### CRITICAL DAMAGE

Avionics	+1	+2	+5	Engine	2	4	D
FCS	+2	+4	D	Gear	+5		
Sensors	+1	+2	+5	Life Support	+2		

### PILOT DATA

Name: \_\_\_\_\_

Gunnery Skill: \_\_\_\_\_ Piloting Skill: \_\_\_\_\_

Hits Taken	1	2	3	4	5	6
Consciousness #	3	5	7	10	11	Dead
Modifier	+1	+2	+3	+4	+5	

### HEAT DATA

Heat Level*	Effects	Heat Sinks: 17 (34) Double
30	Shutdown	
28	Ammo Exp. avoid on 8+	
27	Pilot Damage, avoid on 9+	
26	Shutdown, avoid on 10+	
25	Random Movement, avoid on 10+	
24	+4 Modifier to Fire	
23	Ammo Exp. avoid on 6+	
22	Shutdown, avoid on 8+	
21	Pilot Damage, avoid on 6+	
20	Random Movement, avoid on 8+	
19	Ammo, Exp. avoid on 4+	
18	Shutdown, avoid on 6+	
17	+3 Modifier to Fire	
15	Random Movement, avoid on 7+	
14	Shutdown, avoid on 4+	
13	+2 Modifier to Fire	
10	Random Movement, avoid on 6+	
8	+1 Modifier to Fire	
5	Random Movement, avoid on 5+	

### VELOCITY RECORD

Turn #	1	2	3	4	5	6	7	8	9	10
Thrust										
Velocity										
Effective Velocity										
Altitude										
Turn #	11	12	13	14	15	16	17	18	19	20
Thrust										
Velocity										
Effective Velocity										
Altitude										

# BATTLETECH™

## AEROSPACE FIGHTER RECORD SHEET

### FIGHTER DATA

Type: AESHNA HEAVY DRONE FIGHTER

Thrust: \_\_\_\_\_ Tonnage: 100  
 Safe Thrust: 5 Tech Base: Inner Sphere (Experimental)  
 Maximum Thrust: 8 Jihad

### Weapons & Equipment Inventory

Qty	Type	Loc	Ht	SRV	MRV	LRV	ERV
2	ER Medium Laser [DE]	N	5	5	5	—	—
1	Ultra AC/10 [DB, R/C] L/RW	8	15	15	—	—	—
Ammo (Ultra AC) 10							
1	Large VSP Laser [P,V,AI]	L/RW	9	10	10	7	—

Notes: Aerospace Smart Robotic Control System (Improved)

Fuel: 480 Points

BV: 2,032

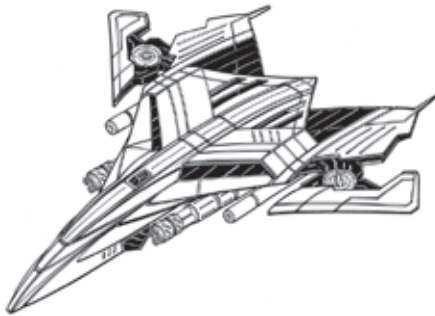

### ARMOR DIAGRAM

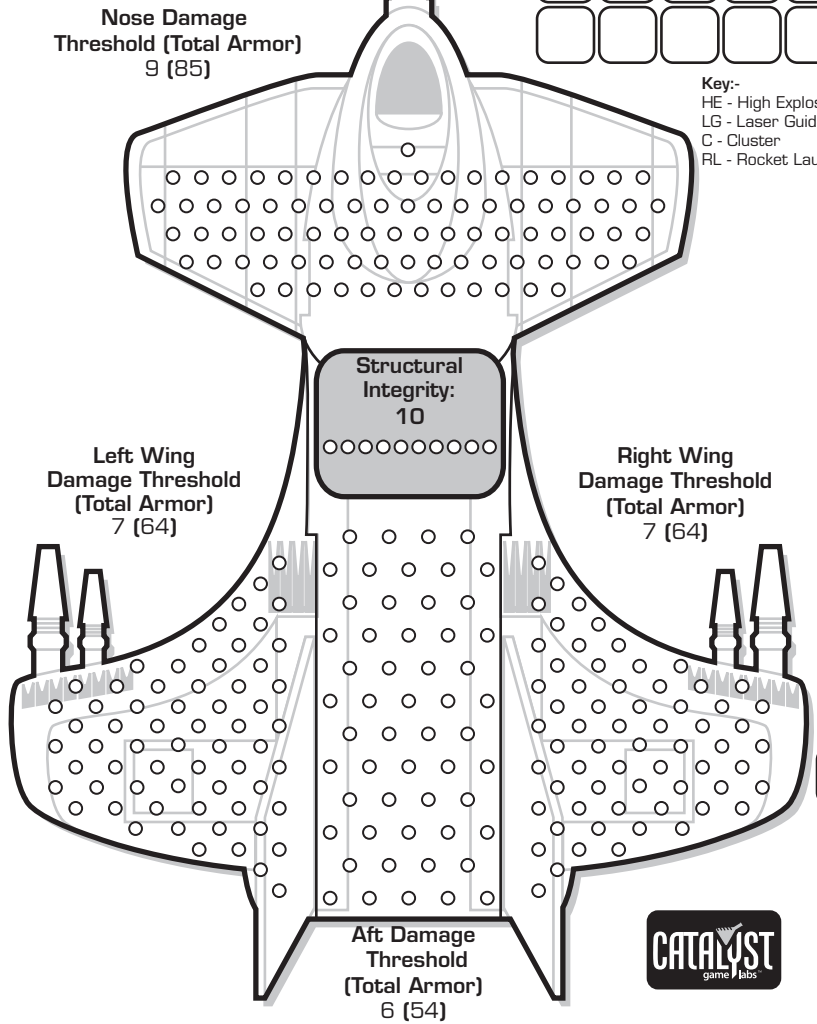

### EXTERNAL STORES/BOMBS

Key:-  
 HE - High Explosive  
 LG - Laser Guided  
 C - Cluster  
 RL - Rocket Launcher

### Heat Scale

Overflow

30*
29
28*
27*
26*
25*
24*
23*
22*
21*
20*
19*
18*
17*
16
15*
14*
13*
12
11
10*
9
8*
7
6
5*
4
3
2
1
0

### CRITICAL DAMAGE

Avionics	+1	+2	+5	Engine	2	4	D
FCS	+2	+4	D	Gear	+5		
Sensors	+1	+2	+5	Life Support	+2		

### PILOT DATA

Name: \_\_\_\_\_

Gunnery Skill: \_\_\_\_\_ Piloting Skill: \_\_\_\_\_

Hits Taken	1	2	3	4	5	6
Consciousness #	3	5	7	10	11	Dead
Modifier	+1	+2	+3	+4	+5	

### HEAT DATA

Heat Level*	Effects	Heat Sinks: 21 (42) Double
30	Shutdown	
28	Ammo Exp. avoid on 8+	
27	Pilot Damage, avoid on 9+	○ ○ ○ ○
26	Shutdown, avoid on 10+	○ ○ ○ ○
25	Random Movement, avoid on 10+	○ ○ ○ ○
24	+4 Modifier to Fire	○ ○ ○ ○
23	Ammo Exp. avoid on 6+	○ ○ ○ ○
22	Shutdown, avoid on 8+	○ ○ ○ ○
21	Pilot Damage, avoid on 6+	○ ○ ○ ○
20	Random Movement, avoid on 8+	○ ○ ○ ○
19	Ammo, Exp. avoid on 4+	○ ○ ○ ○
18	Shutdown, avoid on 6+	○ ○ ○ ○
17	+3 Modifier to Fire	○ ○ ○ ○
15	Random Movement, avoid on 7+	○ ○ ○ ○
14	Shutdown, avoid on 4+	○ ○ ○ ○
13	+2 Modifier to Fire	○ ○ ○ ○
10	Random Movement, avoid on 6+	○ ○ ○ ○
8	+1 Modifier to Fire	○ ○ ○ ○
5	Random Movement, avoid on 5+	○ ○ ○ ○

### VELOCITY RECORD

Turn #	1	2	3	4	5	6	7	8	9	10
Thrust										
Velocity										
Effective Velocity										
Altitude										
Turn #	11	12	13	14	15	16	17	18	19	20
Thrust										
Velocity										
Effective Velocity										
Altitude										

# BATTLETECH™

## ARMOR DIAGRAM

Capital Scale



## SPACE STATION RECORD SHEET

### SPACE STATION DATA

Type: DRAGON'S BREATH PLATFORM

Name: \_\_\_\_\_ Tonnage: 5,000  
 Thrust: \_\_\_\_\_ Tech Base: Inner Sphere  
 Station Keeping Only (Experimental)  
 Jihad

DropShip Capacity: 0

Fighters/Small Craft: 0 / 2 Launch Rate: 2/turn

### Weapons & Equipment Inventory

Standard Scale	(1-6)	(7-12)	(13-20)	(21-25)		
Bay	Loc	Ht	SRV	MRV	LRV	ERV
2 Small Laser	N	2	1(6)			Point Defense
2 Small Laser	FL/FR	2	1(6)			Point Defense
2 Small Laser	AL/AR	2	1(6)			Point Defense
2 Small Laser	A	2	1(6)			Point Defense

**Notes:** Unpressurized bay is permanently fitted with a Dragon's Breath Multiple Capital Launch system. Equipped with an Aerospace Smart Robotic Control System with a Nose firing arc. A Dragon's Breath system has no BV assigned to it. It should only be used in play with the agreement of all players.

**Grav Decks:** Grav Deck #1: 100-meter

**Cargo:** Bay 1: Unpressurized Repair Bay (1 door)  
 (10,000 ton capacity)  
 Bay 2: Small Craft (2) (1 doors)  
 Bay 3: Ore Processing Facility (1)  
 Bay 4: Cargo (1,350 tons) (2 doors)

Ammo: None

BV: 250

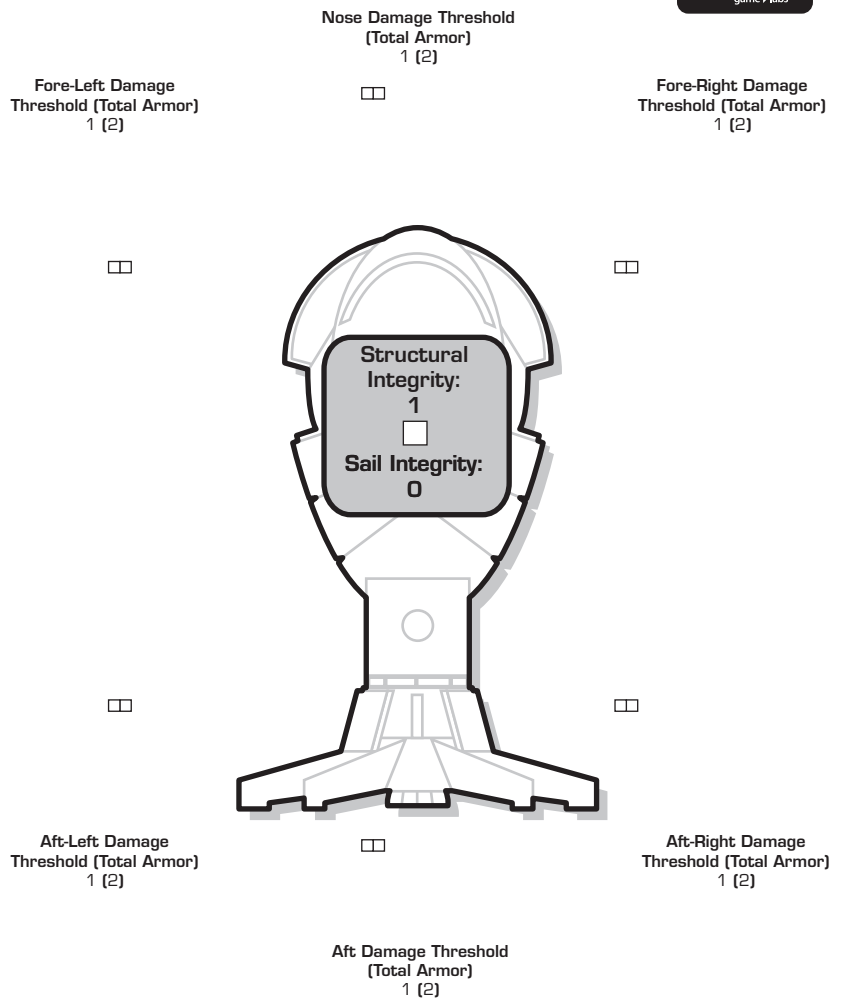

### CREW DATA

Gunnery Skill: \_\_\_\_\_ Piloting Skill: \_\_\_\_\_

Hits Taken	1	2	3	4	5	6
Modifier	+1	+2	+3	+4	+5	Incp.

Crew: 158 Marines: 90  
 Passengers: 0 Elementals: 0  
 Other: 0 Battle Armor: 0  
 Life Boats/Escapes Pods: 15 / 0

### CRITICAL DAMAGE

Avionics	+1	+2	+5	Life Support	+2
CIC	+2	+4	D		
Sensors	+1	+2	+5		
Thrusters					
Left	+1	+2	+3	D	
Right	+1	+2	+3	D	

### HEAT DATA

Heat Sinks:	Heat Generation Per Arc
20	Nose: 6
Single	Left/Right Fore: 6 / 6
	Left/Right Aft: 6 / 6
	Aft: 6

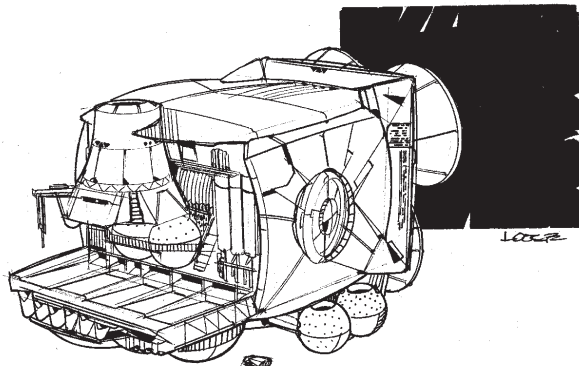

# BATTLETECH

## RATTLER MK II ANTI-AEROSPACE MOBILE FORTRESS

### MOBILE STRUCTURE RECORD SHEET

#### STRUCTURE DATA

**Description:** RATTLER MK II ANTI-AEROSPACE MOBILE FORTRESS

**MP:** 2

**Levels:** 7 (Hardened)

**Movement Type:** Tracked

**Tech Base:** Inner Sphere

**Powerplant Type:** Fusion

(Advanced)  
Jihad



#### Weapons & Equipment Inventory

Qty	Type	Hex/ Location	Dmg	Min	(Hexes)			Lng
					Sht	Med	Med	
1	Sub_Capital Laser/3	1/5	[CAP,AE]	—	—	—	—	—
2	Light Machine Gun (400 rnds)	1/2	1 [DB,AI]	—	2	4	6	—
2	Streak SRM 6 (45 salvos)	1/2	2/Msl [M,C]	—	3	6	9	—
2	LRM 20+Artemis (48 salvos)	1/2	1/Msl [M,C,S]	6	7	14	21	—
1	Heavy Gauss Rifle (96 rnds)	1/2	25/20/10 [DB,X,V]	4	6	13	20	—
2	Anti-Missile System (48 rnds)	1/2	[PD]	—	—	—	—	—
1	Long Tom (200 rnds)	2/T	25A [AE,S,F]	—	30	boards	—	—
1	Arrow IV Missile (60 misl)	2/T	20A [AE,SF]	—	8	boards	—	—
2	Streak SRM 6 (45 salvos)	2/2	2/Msl [M,C]	—	3	6	9	—
4	Machine Gun (400 rnds)	2/2	2 [DB,AI]	—	1	2	3	—
2	Large Pulse Laser	2/2	9 [P]	—	3	7	10	—
2	Anti-Missile System (48 rnds)	2/2	[PD]	—	—	—	—	—
1	Sub_Capital Laser/3	3/5	[CAP,AE]	—	—	—	—	—
1	Barracuda Missile (15 misl)	3/5	[CAP,AE]	—	—	—	—	—
2	Streak SRM 6 (45 salvos)	3/2	2/Msl [M,C]	—	3	6	9	—
4	Machine Gun (400 rnds)	3/2	2 [DB,AI]	—	1	2	3	—
2	Large Pulse Laser	3/2	9 [P]	—	3	7	10	—
2	Anti-Missile System (48 rnds)	3/2	[PD]	—	—	—	—	—
1	Barracuda Missile (15 misl)	4/5	[CAP,AE]	—	—	—	—	—
2	Streak SRM 6 (45 salvos)	4/2	2/Msl [M,C]	—	3	6	9	—
4	Machine Gun (400 rnds)	4/2	2 [DB,AI]	—	1	2	3	—
2	Large Pulse Laser	4/2	9 [P]	—	3	7	10	—
2	Anti-Missile System (48 rnds)	4/2	[PD]	—	—	—	—	—
1	Barracuda Missile (15 misl)	5/5	[CAP,AE]	—	—	—	—	—
2	Streak SRM 6 (45 salvos)	5/2	2/Msl [M,C]	—	3	6	9	—
4	Machine Gun (400 rnds)	5/2	2 [DB,AI]	—	1	2	3	—
2	Large Pulse Laser	5/2	9 [P]	—	3	7	10	—
2	Anti-Missile System (48 rnds)	5/2	[PD]	—	—	—	—	—
1	Sub_Capital Laser/3	6/5	[CAP,AE]	—	—	—	—	—
2	Light Machine Gun (400 rnds)	6/2	1 [DB,AI]	—	2	4	6	—
2	Streak SRM 6 (45 salvos)	6/2	2/Msl [M,C]	—	3	6	9	—
2	LRM 20+Artemis (48 salvos)	6/2	1/Msl [M,C,S]	6	7	14	21	—
1	Heavy Gauss Rifle (96 rnds)	6/2	25/20/10 [DB,X,V]	4	6	13	20	—
2	Anti-Missile System (48 rnds)	6/2	[PD]	—	—	—	—	—
1	Long Tom (200 rnds)	7/T	25A [AE,S,F]	—	30	boards	—	—
1	Arrow IV Missile (60 misl)	7/T	20A [AE,SF]	—	8	boards	—	—
2	Streak SRM 6 (45 salvos)	7/2	2/Msl [M,C]	—	3	6	9	—
4	Machine Gun (400 rnds)	7/2	2 [DB,AI]	—	1	2	3	—
2	Large Pulse Laser	7/2	9 [P]	—	3	7	10	—
2	Anti-Missile System (48 rnds)	7/2	[PD]	—	—	—	—	—

**Notes:**

Light Vehicle Bays: 4 (2 Hex 2, 2 Hex 6)  
Jump Infantry Bays: 6 (3 Hex 2, 3 Hex 7)

Doors: 1 Hex 1, 2 Hex 4, 2 Hex 5, 1 Hex 6.

1 MASH unit with 2 additional theatres (Hex 3), 10 tons communications equipment (Hex 3), 2 field kitchens (Hex 3), 4 lift hoists (2 Hex 2, 2 Hex 7), 4 arresting hooks (2 Hex 1, 2 Hex 6).

Cargo: 636 tons (25t Hex 1, 180t Hex 2, 89t Hex 3, 22t Hex 4, 22t Hex 5, 15t Hex 6, 283t Hex 7).

BV: 14,495

#### CREW DATA

**Crew:** 43 Officers  
42 crew  
105 gunners  
177 bay personnel

**Gunnery Skill:** \_\_\_\_\_

**Notes:**

24 crew quarters (6 Hex 2, 12 Hex 3, 6 Hex 7) used for double occupancy officers, 98 steerage quarters (12 Hex 1, 22 Hex 2, 25 Hex 3, 14 Hex 6, 25 Hex 7) used for triple occupancy crew.

#### CF & ARMOR

Hex	CF	Armor	Hex	CF	Armor
1	150	150			
2	150	150			
3	150	150			
4	150	150			
5	150	150			
6	150	150			
7	150	150			



# BATTLETECH

## WYRM SDS MOBILE PLATFORM

### MOBILE STRUCTURE RECORD SHEET

#### STRUCTURE DATA

Description: WYRM SDS MOBILE PLATFORM

MP: 4

Levels: 10 (Hardened)

Movement Type: Naval

Tech Base: Inner Sphere

Powerplant Type: Fusion

(Advanced)  
Jihad

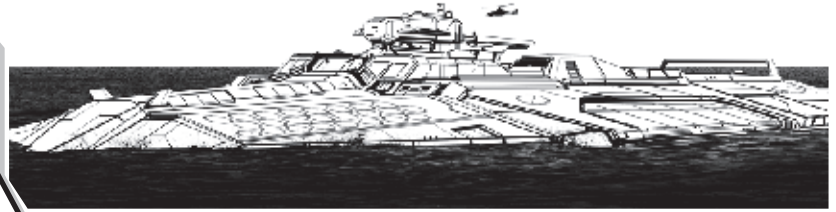

#### Weapons & Equipment Inventory

Qty	Type	Hex/ Location	Dmg	Min	(Hexes)			Qty	Type	Hex/ Location	Dmg	Min	(Hexes)		
					Sht	Med	Lng						Sht	Med	Lng
4	LRT 20+Artemis (120 salvos)	1/5	1/Torp. [M,C,S]	6	7	14	21	1	NL 55	15/10	[CAP,AE]	—	—	—	—
4	ER Large Laser	1/5	8 [DE]	—	7	14	19	2	ER PPC	15/5	10 [DE]	—	7	14	23
4	SRT 6+Artemis (120 salvos)	1/5	2/Torp. [M,C,S]	—	3	6	9	2	LRT 20+Artemis (120 salvos)	15/5	1/Torp. [M,C,S]	6	7	14	21
6	Medium Pulse Laser	1/5	6 [P]	—	2	4	6	2	SRT 6+Artemis (120 salvos)	15/5	2/Torp. [M,C,S]	—	3	6	9
4	Laser AMS	1/5	[PD]	—	—	—	—	4	Medium Pulse Laser	15/5	6 [P]	—	2	4	6
2	Arrow IV Missile (60 misl)	2/T	20A [AE,SF]	—	8	boards	—	4	Laser AMS	15/5	[PD]	—	—	—	—
2	Gauss Rifle (80 rnds)	2/T	15 [DB,X]	2	7	15	22	2	Arrow IV Missile (60 misl)	16/T	20A [AE,SF]	—	8	boards	—
4	LB 2-X AC (540 rnds)	2/T	2 [DB,C/S/F]	4	9	18	27	2	Gauss Rifle (80 rnds)	16/T	15 [DB,X]	2	7	15	22
4	LRM 20+Artemis (120 salvos)	2/T	1/Msl. [M,C,S]	6	7	14	21	4	LB 2-X AC (540 rnds)	16/T	2 [DB,C/S/F]	4	9	18	27
2	SRT 6+Artemis (120 salvos)	2/5	2/Torp. [M,C,S]	—	3	6	9	4	LRM 20+Artemis (120 salvos)	16/T	1/Msl. [M,C,S]	6	7	14	21
4	Medium Pulse Laser	2/5	6 [P]	—	2	4	6	2	SRT 6+Artemis (120 salvos)	16/5	2/Torp. [M,C,S]	—	3	6	9
2	Laser AMS	2/5	[PD]	—	—	—	—	4	Medium Pulse Laser	16/5	6 [P]	—	2	4	6
1	NL 55	3/10	[CAP,AE]	—	—	—	—	2	Laser AMS	16/5	[PD]	—	—	—	—
2	Arrow IV Missile (60 misl)	4/T	20A [AE,SF]	—	8	boards	—	4	LRT 20+Artemis (120 salvos)	17/5	1/Torp. [M,C,S]	6	7	14	21
2	Gauss Rifle (80 rnds)	4/T	15 [DB,X]	2	7	15	22	4	ER Large Laser	17/5	8 [DE]	—	7	14	19
4	LB 2-X AC (540 rnds)	4/T	2 [DB,C/S/F]	4	9	18	27	4	SRT 6+Artemis (120 salvos)	17/5	2/Torp. [M,C,S]	—	3	6	9
4	LRM 20+Artemis (120 salvos)	4/T	1/Msl. [M,C,S]	6	7	14	21	6	Medium Pulse Laser	17/5	6 [P]	—	2	4	6
2	SRT 6+Artemis (120 salvos)	4/5	2/Torp. [M,C,S]	—	3	6	9	4	Laser AMS	17/5	[PD]	—	—	—	—
4	Medium Pulse Laser	4/5	6 [P]	—	2	4	6	2	Arrow IV Missile (60 misl)	18/T	20A [AE,SF]	—	8	boards	—
2	Laser AMS	4/5	[PD]	—	—	—	—	2	Gauss Rifle (80 rnds)	18/T	15 [DB,X]	2	7	15	22
2	Barracuda Missile (30 misl)	5/10	[CAP,AE]	—	—	—	—	4	LB 2-X AC (540 rnds)	18/T	2 [DB,C/S/F]	4	9	18	27
1	NL 55	6/10	[CAP,AE]	—	—	—	—	4	LRM 20+Artemis (120 salvos)	18/T	1/Msl. [M,C,S]	6	7	14	21
2	Barracuda Missile (30 misl)	7/10	[CAP,AE]	—	—	—	—	2	SRT 6+Artemis (120 salvos)	18/5	2/Torp. [M,C,S]	—	3	6	9
4	ER PPC	8/T	10 [DE]	—	7	14	23	4	Medium Pulse Laser	18/5	6 [P]	—	2	4	6
2	Large VSP Laser	8/T	11/9/7 [PV,Al]	—	4	8	15	2	Laser AMS	18/5	[PD]	—	—	—	—
4	LRT 20+Artemis (120 salvos)	8/5	1/Torp. [M,C,S]	6	7	14	21	2	Laser AMS	18/5	[PD]	—	—	—	—
4	ER Large Laser	8/5	8 [DE]	—	7	14	19	Notes:							
4	SRT 6+Artemis (120 salvos)	8/5	2/Torp. [M,C,S]	—	3	6	9	Super-heavy Vehicle Bays: 4 (Bays [2 Hex 2, 2 Hex 4])							
6	Medium Pulse Laser	8/5	6 [P]	—	2	4	6	Heavy Vehicle Bays: 8 (4 Hex 2, 4 Hex 4)							
4	Laser AMS	8/5	[PD]	—	—	—	—	Light Vehicle Bays: 4 Light Vehicle Bays (Hex 17)							
1	Killer Whale (24 Misl.)	9/10	[CAP,AE]	—	—	—	—	Doors: 2 Hex 8, 1 Hex 9, 1 Hex 11, 2 Hex 12, 1 Hex 13, 1 Hex 14, 1 Hex 15, 1 Hex 16, 1 Hex 18.							
1	Killer Whale (24 Misl.)	11/10	[CAP,AE]	—	—	—	—	1 MASH unit with 10 additional theatres (Hex 6), 20 tons communications equipment (Hex 10), 3 field kitchens (Hex 10), 1 helipad (Hex 17), 2 mobile field bases (Hex 17), 4 lift hoists (Hex 17).							
4	ER PPC	12/T	10 [DE]	—	7	14	23	Cargo: 4224.5 tons (231.5t Hex 1, 134.5t Hex 2, 72.5t Hex 3, 134.5t Hex 4, 269.5t Hex 5, 59t Hex 6, 269.5t Hex 7, 285.5t Hex 8, 2.5t Hex 9, 578.5t Hex 10, 2.5t Hex 11, 285.5t Hex 12, 32.5t Hex 13, 107.5t Hex 14, 32.5t Hex 15, 794.5t Hex 16, 137.5t Hex 17, 794.5t Hex 18).							
2	Large VSP Laser	12/T	11/9/7 [PV,Al]	—	4	8	15								
4	LRT 20+Artemis (120 salvos)	12/5	1/Torp. [M,C,S]	6	7	14	21								
4	ER Large Laser	12/5	8 [DE]	—	7	14	19								
4	SRT 6+Artemis (120 salvos)	12/5	2/Torp. [M,C,S]	—	3	6	9								
6	Medium Pulse Laser	12/5	6 [P]	—	2	4	6								
4	Laser AMS	12/5	[PD]	—	—	—	—								
1	NL 55	13/10	[CAP,AE]	—	—	—	—								
2	ER PPC	13/5	10 [DE]	—	7	14	23								
2	LRT 20+Artemis (120 salvos)	13/5	1/Torp. [M,C,S]	6	7	14	21								
2	SRT 6+Artemis (120 salvos)	13/5	2/Torp. [M,C,S]	—	3	6	9								
4	Medium Pulse Laser	13/5	6 [P]	—	2	4	6								
4	Laser AMS	13/5	[PD]	—	—	—	—								
1	Killer Whale-T (22 Misl.)	14/10	[CAP,AE]	—	—	—	—								

BV: 47,107

#### CREW DATA

Crew: 100 Officers  
108 crew  
324 gunners  
243 bay personnel  
36 Battle Armor  
36 Marines

Notes:  
36 steerage quarters (Hex 1), 356 crew quarters (80 Hex 1, 80 Hex 8, 80 Hex 10, 80 Hex 12, 36 Hex 17), 50 officer quarters (10 Hex 1, 10 Hex 8, 10 Hex 10, 20 Hex 12). All crew and officer quarters are double occupancy.

Escape Pods: 40 (20 Hex 16, 20 Hex 18)  
Escape Pods (Maritime): 30 (10 Hex 1, 10, Hex 8, 10 Hex 12).

#### CF & ARMOR

Hex	CF	Armor	Hex	CF	Armor
1	150	150	11	150	150
2	150	150	12	150	150
3	150	150	13	150	150
4	150	150	14	150	150
5	150	150	15	150	150
6	150	150	16	150	150
7	150	150	17	150	150
8	150	150	18	150	150
9	150	150	19	150	150



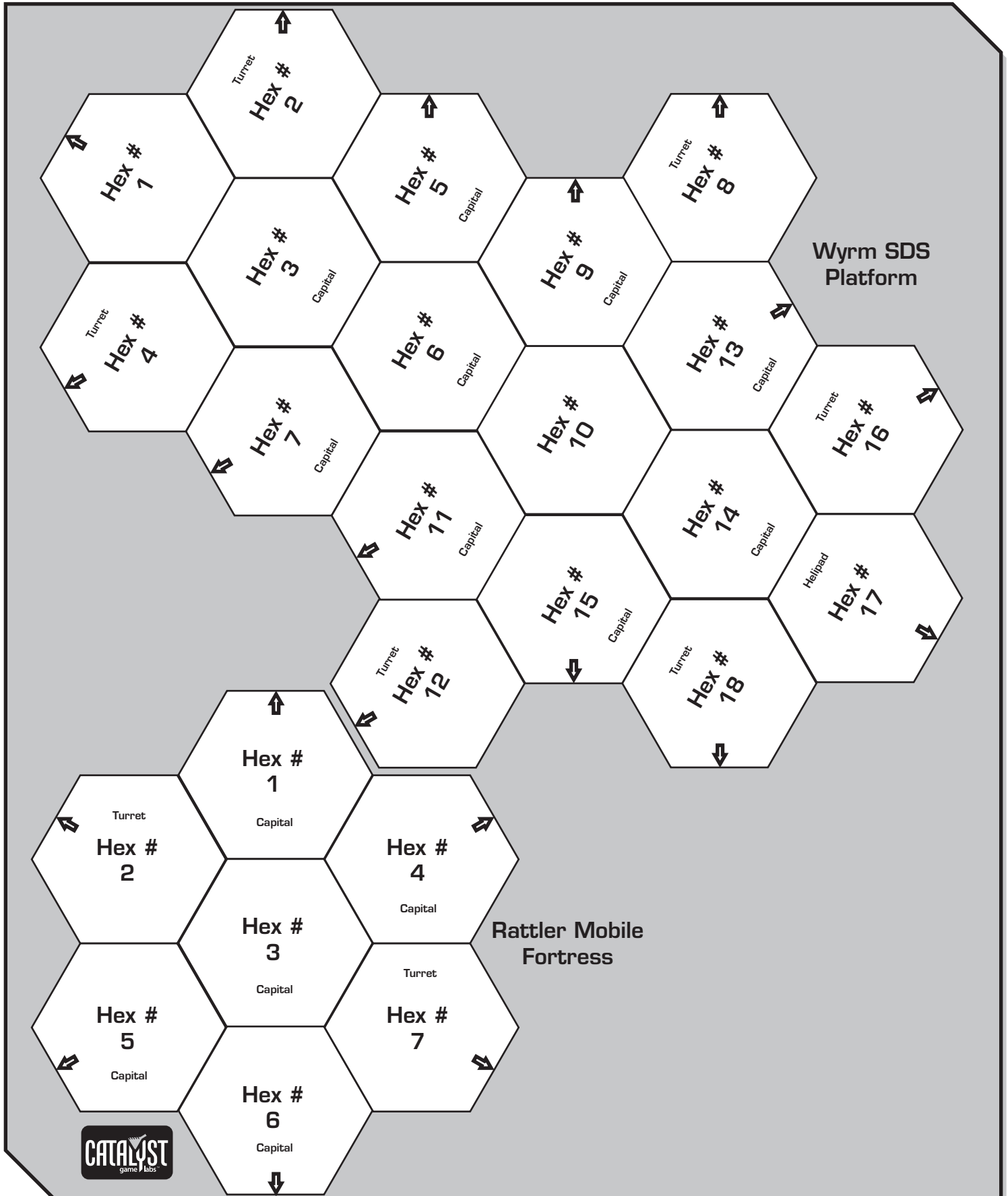

Fortified Brian Wall

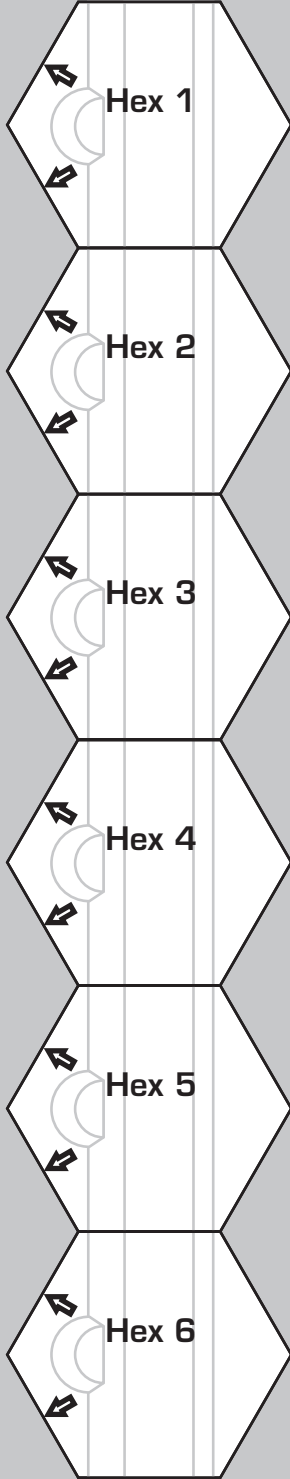

Automated Anti-  
Personnel Turret



Automated Anti-  
Personnel Turret



Automated Anti-  
Personnel Turret



Gun  
Emplacement

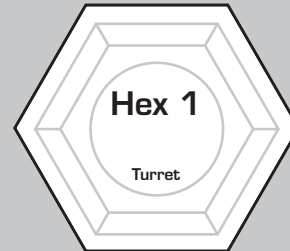

Gun  
Emplacement

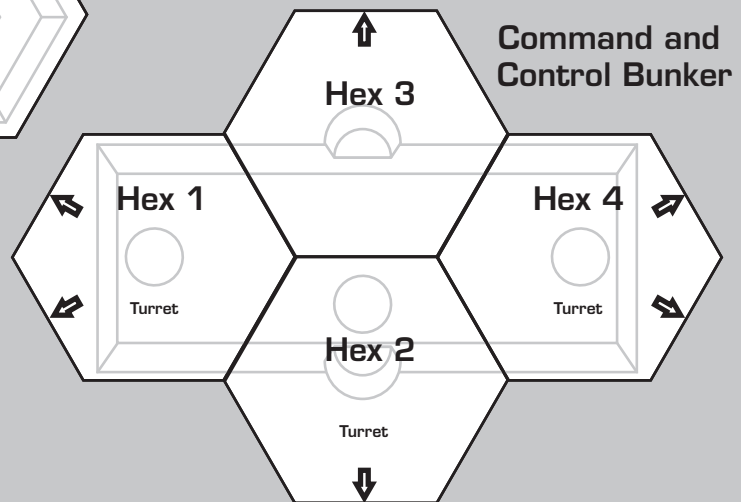

Command and  
Control Bunker





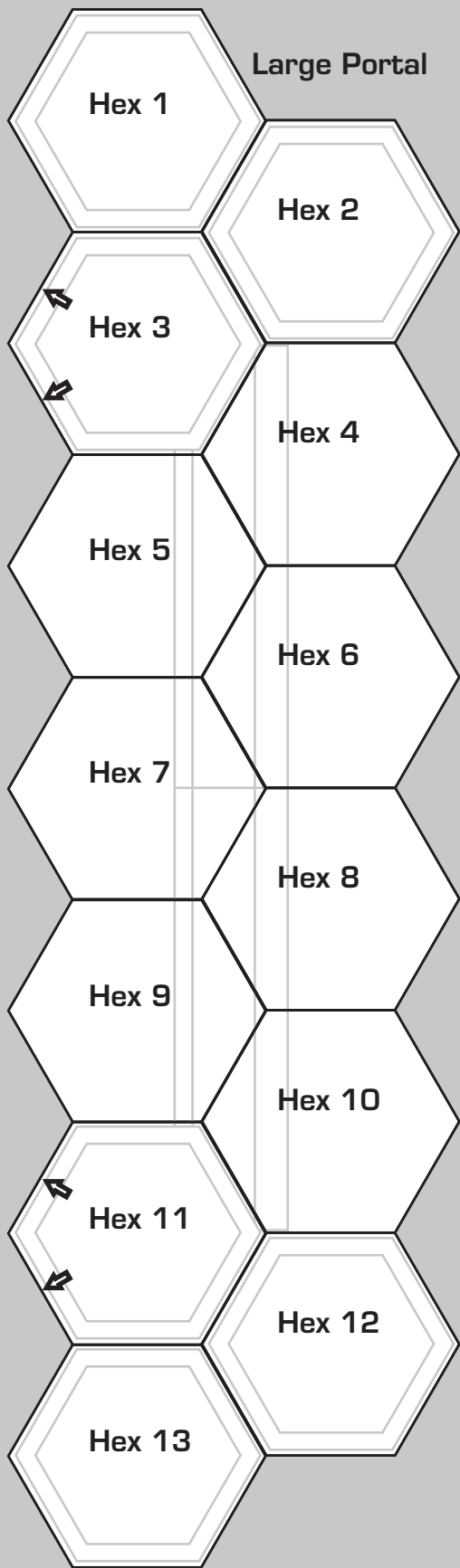

Reinforced Weapons  
Bunker

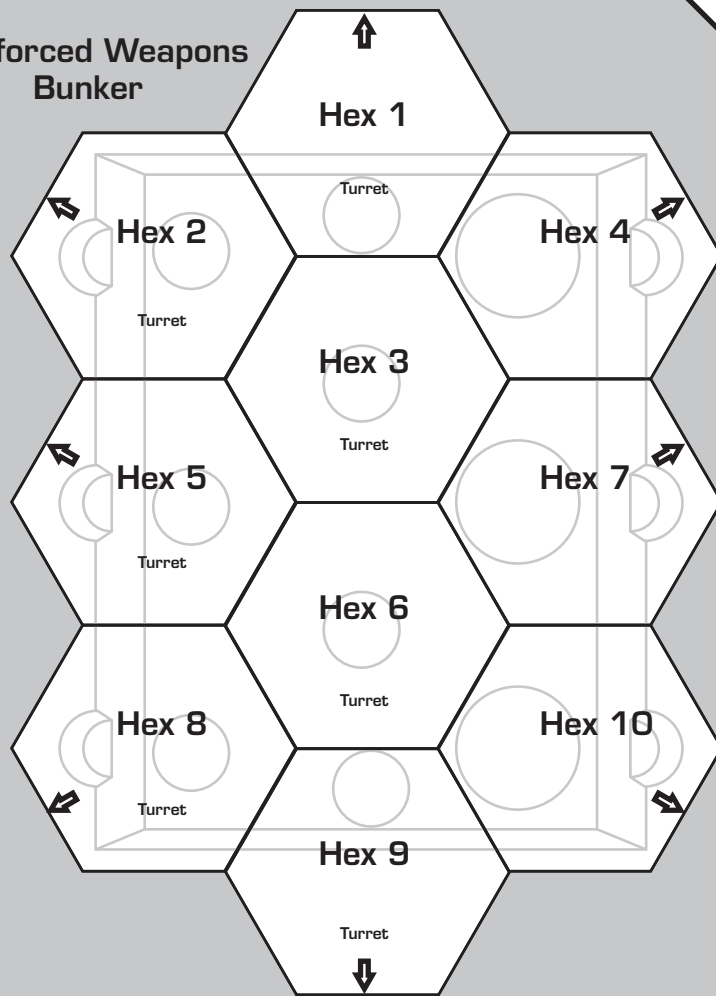

Anti-Aerospace  
Bunker

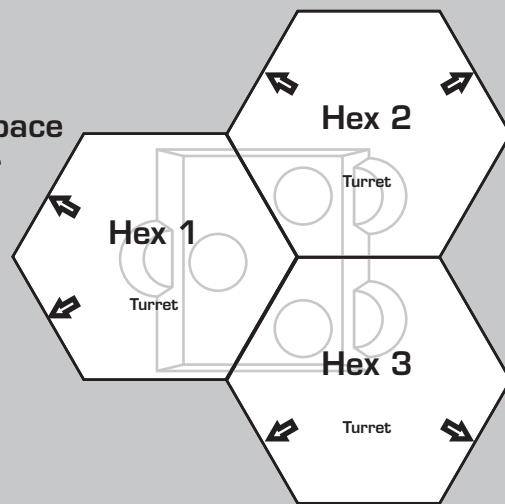



Aerospace Hanger

