

Issue #8

US \$4.95

BattleTechnology

The Magazine of Combat in the 31st Century

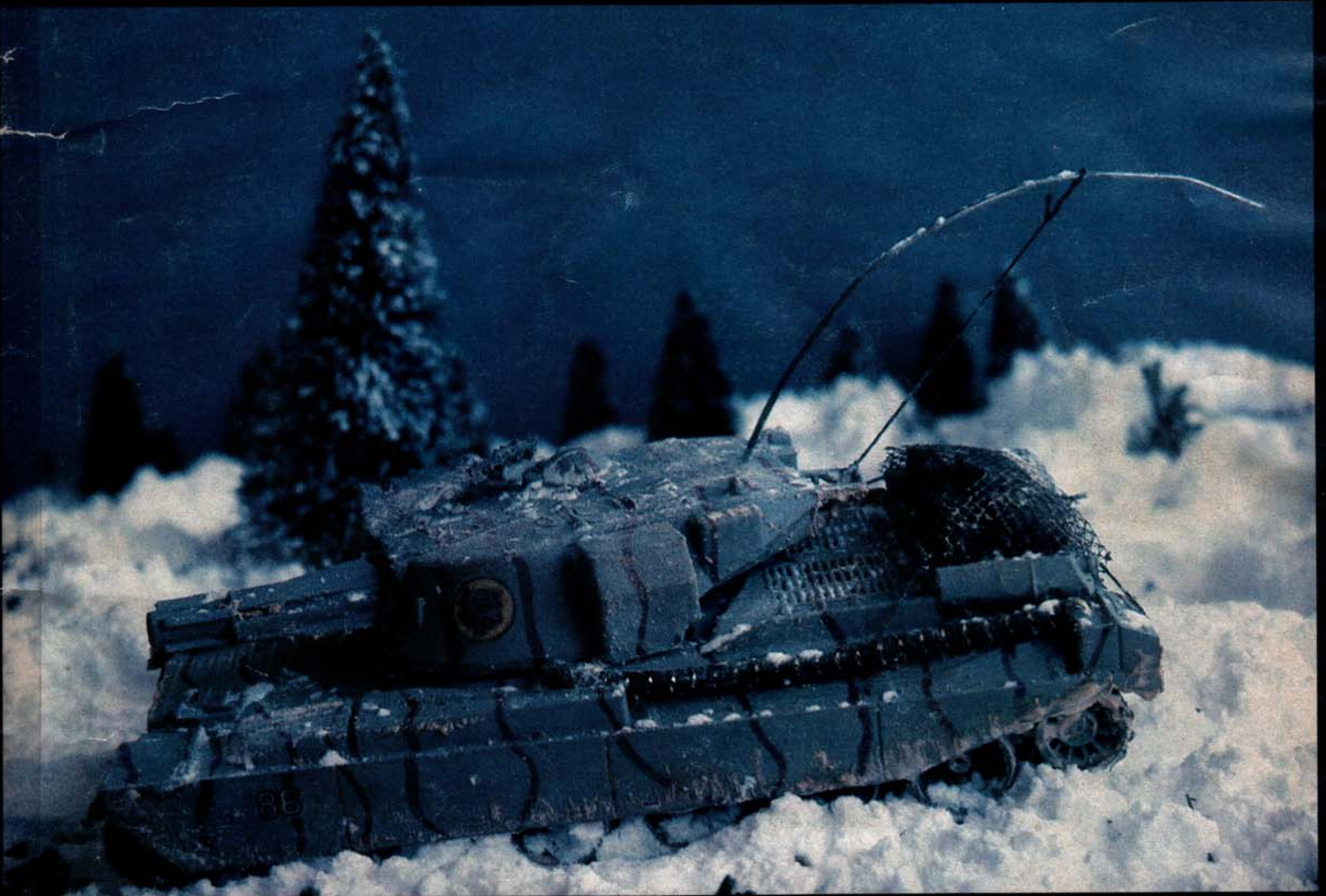

Kurita Slays Steiner



BattleTechnology

The Magazine of Combat in the 31st Century
The **only** authoritative news magazine covering the Inner Sphere.

BattleTechnology . . . The best way to make sure your customers return . . . alive!

— Abraxis (Mo) Murasaki, Owner
Battletechnic Military Salvage

BattleTechnology, with its **BattleTech Simulator**, is the best Mech Warrior training device I know — since I made it required reading, the Fourth Succession War is a success!

— Captain Mamluke 'ap Prentiss,
Drillmaster, The Faroes' Own
Independent Lowlanders

BattleTechnology tells me which way to duck — and which employer is thinking of ducking out on the bill! I buy your magazine before I buy coolant!

—MechWarrior Kent Worthington,
Hiring Hall Veteran

BattleTechnology is available from finer merchants throughout the Inner Sphere, from our publishing house on New Avalon, or from:

BattleTechnology Post Office Box 23651

Oakland, California, 94623

Subscriptions are available at \$24 US in the US, \$27 US in Canada, \$48 US elsewhere on Earth.

Back issues still available postpaid at \$3.95 in US, \$4.95 US in Canada, \$5.95 elsewhere on Earth.

0101, August 3027 — report on Davion Op Goliath, MechWarrior mental discipline, FLC-4N 'Falcon' Mech, Battle of Kilgore Engine Swaps, Combat drop on Scheat V, more.

0102, December 3027 — Combat Salvage, Camouflage, Hassid Ricol: The Red Duke, Black Luthien: the Draconis capital, DVE-5B 'Devastor'

0201, February 3028 — Tharkad, Decompression, GLD-3R 'Gladiator', BattleMech Weapons — range versus accuracy, Galaina the Pleasure Planet, Vacuum combat, more.

0202, April 3028 — Hanse Davion Interview, Cavalry Tactics & Applications, Lasers, Banshee BattleMech, Dragonslayers, Battle at Wittingate, Late-Breaking News, more.

0203, June 3028 — Maximilian Liao Interview, Kearny Highlanders on Mira, Liao Edge on Solaris, Urban Camouflage, more

0204, August, 3028 — WAR ISSUE, Goliaths on St Andre, Miniatures Combat, Reports From the Front, Close Assault Rules

#7, December 3028 — ALI-1A Alliance, BattleMech Technician, The Phransigar, Waves 1-4 of the Fourth Succession War

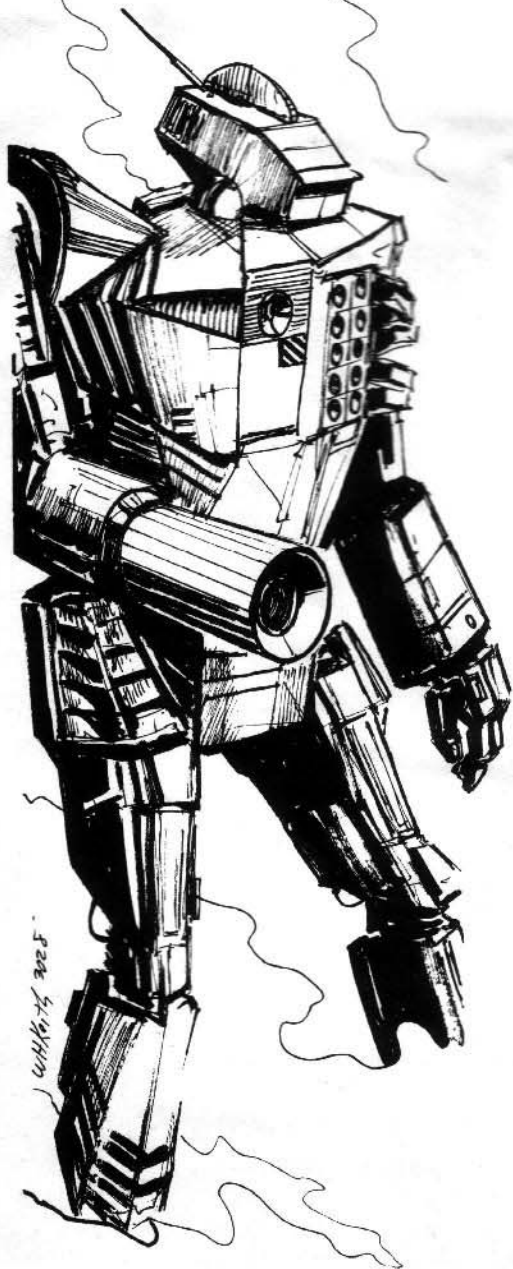

BattleTech is a registered trademark of FASA Corporation, Chicago, Illinois, and is used with permission.

BattleTechnology

The Magazine of Combat in the 31st Century

Issue #8
September 3029

Publisher: Jeffrey Tibbetts
Assistant to the Publisher: Hilary Ayer

Editor: Bob Carter
Editorial Coordinator: Hilary Ayer
Founding Editor: William H Keith Jr
Founding Art Director: Nina Barton
Limited Consultant: Robert Tibbetts

Editorial Offices:
BattleTechnology
3833 Lake Shore Avenue
Oakland, CA 94610

BattleTech, *CityTech*, *AeroTech*, *Mech*, *MechWarrior*, and *BattleForce* are registered trademarks of FASA Corporation, Chicago, Illinois, and are used with permission.

PACIFIC RIM PUBLISHING COMPANY
3833 Lake Shore Avenue
Oakland, CA 94610

Kenneth Gaydish Chairman
Jeffrey Tibbetts President

BattleTechnology The Magazine of Combat in the 31st Century [ISSN 0895-030X] is published bimonthly by Pacific Rim Publishing Company, 3833 Lake Shore Avenue, Oakland, California 94610. Subscription rates are \$24.00 for six issues in the USA, APOs, and FPOs; \$30.00 for six issues in Canada; \$48.00 for six issues elsewhere via air mail. All payments must be made in US funds drawn on accounts in the USA or postal money orders. POSTMASTER: Send address changes to BattleTechnology, P.O. Box 23651, Oakland, CA 94623. BattleTechnology is a publication of Pacific Rim Publishing Company. Printed in the USA. Copyright 1988 Pacific Rim Publishing Company. All rights reserved.

Cover: Michael Haggerty and Nelson Snook
Photography: Nelson Snook and Michael Haggerty
Art in this issue:
Athena, and *Fighting Spirit* by Eric Gaydish
Michael Hasek Davion, *Theodore Kurita*, and *Thornhill Arms* by Rae Phillips
Maps by Stefan Paul Melin-Dempsey
All other Art by William H Keith Jr

Correction of BattleTechnology # 7 Masthead
Art in BattleTechnology #7 which should have been credited appeared on pgs 2, 12, 15, and inside front cover are by William H Keith, Jr
SCR-1A Screaming Hawk by Dennis Greene

Writing in this issue:
McKlostey's Valley by WR Shumaker
Fighting Spirit, *Thornhill Arms*, and *LosTech* ad by Glen L Mitchell
The Price of Cannon Fodder by John Theissen
Guerillas on Glenmora, *Athena FDC Carrier* by Michael Hebert
Tales Your Mother Never Told You, *Death of a Regiment* by Stefan Paul Melin-Dempsey
Nature's Woe and *Mary had a Stinger LAM* by Jeffrey M Shealy
All other writing this issue by Hilary Ayer

About the Cover:

This issue's cover features a Patton tank taken two years ago during Spring training on the then-Liao, now-Davion world of Second Try. It may be the tank mentioned in *Blood on the Snow*, page 16.

Contents

McKlostey's Valley	32
Darryl James	
Fighting Spirit	22
S. Jansfield	
Blood on the Snow	16
Li Tsien-Tu	

DEPARTMENTS

BattleTechnology News Service	3
News From the Front	
Kurita Slays Steiner	6
Guerillas on Glenmora	8
In Memoriam	
Michael Hasek-Davion	12
Mech(Warrior)Tac—BattlePreparedness	
Silence and Spirit	10
BattleMechanics—	
Technical Readout	
Athena FDC Carrier	50
Technical Readout	
Flea-14 Flea Variant	27
BattleTechnology Blueprint # 1	30
Flea-14 Flea Variant	
ComStar Census	inside back cover

BATTLETECH SIMULATOR

The Price of Cannon Fodder	40
Jack Freeman, MechTech P.E.	
Tales Your Mother Never Told You	56
Death of a Regiment	58
The Snows of Battle	54

More Than Warriors —

Mary Had A Stinger LAM	47
M. Madigan	
Nature's Woe	21
Brother Noto Shimatsu	

Distribution:

American & Canada: Your favorite Game or Comic Distributor

Australia:

Jedko Games, 134 Cochranes Rd, Morabbin, Victoria 3189

UK & Europe:

TM Games, Chart House, Station Rd, East Preston, Littlehampton

West Sussex BN 16 3AG, England

OPENING SHOTS

Where were you when you heard that

the Fourth Succession War had started? I was buying food for a party, wondering if my budget would stretch to real coffee for the dessert course, when I noticed that the checkout computers were deserted. I followed a thread of sound to the manager's office to find the entire personnel of the store and several other customers listening to a replay of the now-famous wedding toast, "I give you the Capellan Confederation!" The manager opened a bottle of warm champagne and we toasted "Victory by Christmas". I did not admit to being a neutral; suddenly I didn't feel it was safe.

Memory skips now; I cannot recall what became of those groceries. I attempted to put a call though to my brother, but his unit had already been activated. No calls were allowed in or out. I recorded a message, trying to keep my fear from showing. If my family has a motto it's, "Don't upset a warrior going into battle unless you want to sabotage his fighting ability." That comes right before "Don't yodel when your father is taking a nap!" and "If they aren't your coloring pens, keep your hands off!". My guests arrived, some in a party mood (those who hadn't heard yet), and some late, stopping by to say they had business to take care of and couldn't stay. Two never made it at all; one called to denounce me as a traitor because she knew that as a staff member of BattleTechnology, I would not be taking part in the war effort. I called the office; her call had reminded me of our contingency plan for the possibility of war. I was told to pack a bag and report in; "leave what you can't carry. Don't wait for the planetary police — or a mob; get out now, and get out alive." I packed, told my friends to help themselves to what remained, and walked through menacingly silent streets to the office. Just as I arrived, the first fighters were taking to the air.

That evening is seven months ago now, and clearer to me than yesterday. Neither my brother nor my sister has spoken to me since; one is missing since the second wave of Operation Götterdämmerung, and one is with her mercenary unit on the opposite side. We're a miniature of all the families torn by this war; I only hope that when it's over we'll be able to clear the air between us.

Everyone I talk to has a clear memory of that afternoon or evening when the coverage of a royal wedding in far-off Terra gave way to the knowledge that our peoples were going to war. Where were you? On duty? Taking a shower? At a library studying? Write us a short paragraph and tell us where you were and how you and your associates reacted to the start of the war. Do it within the next Terran Standard Month; send it to us, and there's a good chance you'll see it printed in BattleTechnology.

In this issue, Bob Carter files a story of action with the 10th Deneb Lt Cavalry, We continue excerpts from the testimony of Team Banzai's Kahil Holt, involved in the accusations and counter accusations of events last winter on the planet Northwind, a militiawoman gives us her side of the story from Second Try — for a lighter note, an incident we can't confirm, told in a bar on Solaris; and Lt Darryl James tells us where he was when the Great War started.

In response to complaints from all sides of the Fourth Succession War, Bob Carter asks me to inform you that our staff originates from planets in all the Five Successor States as well as several planetary and system groupings in the Periphery. BattleTechnology *must* continue to provide neutral coverage; we were founded to keep a flow of information to all warrior personnel; no matter how difficult this is made for us, we will continue to serve in our peculiar and necessary way, taking no sides.

September 3029, New Syrtis

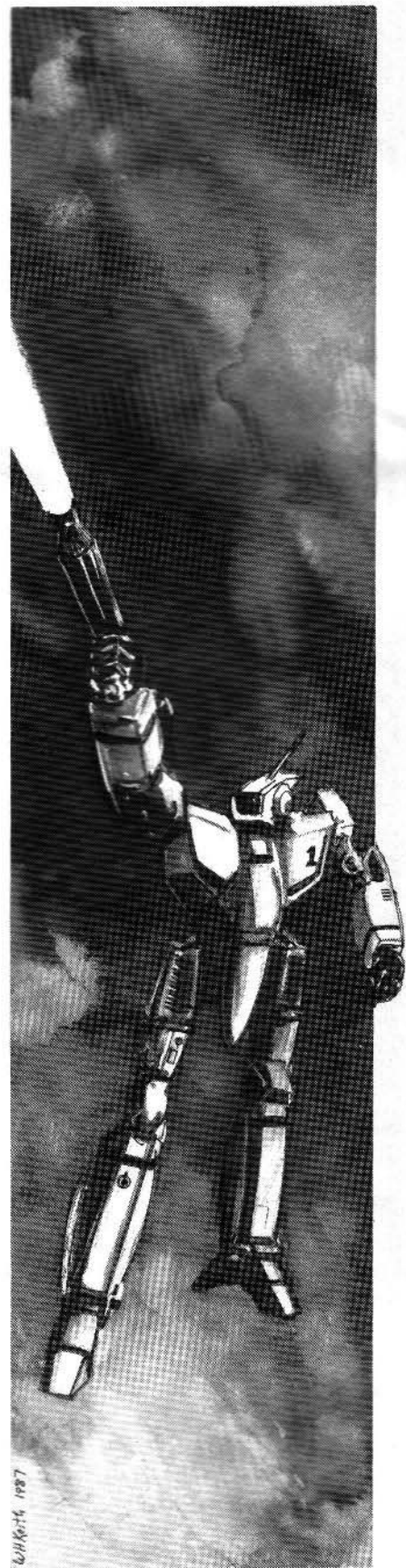

BattleTechnology News Service

**Stop Press
News!**

Davion Heir Captured!

*September 7, 3029, Kathil
Capellan March, Federated Suns*

When the Federated Suns received intelligence that the Capellans intended a raid in force against the shipyards at Kathil, extraordinary measures were called for. If the shipyard here, one of the very few in known space capable of producing not just dropships but jumpships, if this shipyard were to be destroyed it would be a loss to all of humanity. The rescue demanded a leader of the highest caliber and leadership qualities. But the AFFS is stretched to the limit carrying out the Fourth Succession War under the conditions imposed by ComStar's Interdict. The high command determined that only Prince Hanse himself or his heir Duke Morgan Hasek-Davion had a chance at pulling off this vital and tricky mission. Duke Morgan has been kept out of the fighting, much against his will, to safeguard the line of succession. This time, reluctantly, Prince Hanse had to let him go. It is typical of the able and charismatic Duke that en route to the planet he reorganized his troops, joining them with local forces of all descriptions into a new combat unit, the First Kathil Uhlans (*Lions of Davion*). In under a week the unit had become an effective force.

Liao's Fourth Tao Ceti Rangers' target was the geothermal generating stations of Kathil. They expected and found heavy fighting. (During this fight the vid's favorite warrior, Hunchback Pilot Robert Craon was badly wounded. The charismatic young officer seems to be on the mend at last report.) Battlefield reporters could not predict this one; it went one way and then the other. The fighting continued long after planetary night fell on the northern hemisphere.

Confusion ended when the announcement of Duke Morgan's capture was broadcast over Capellan Military frequencies. Ships of the Tao Ceti Rangers are reported to be conveying the heir to the Liao capitol of Sian.

New Avalon Attacked! Prince Hanse Fights Back!

September 10, 3029 2:23 am local time, New Avalon

The AFFS overlord-class Dropship *Camelot* was cleared for landing late this evening. As it landed it discharged Liao Death Commandos intent on the New Avalon Institute of Science. Alert Captain Nicholas Kilters, the duty officer at the port, somehow recognized an anomaly in the accent of the communications officer of the ship; Capt Kilters sounded the alarm. At the NAIS, the wounded Dr Banzai of Team Banzai led a guerilla attack against the invaders. Scientists and students who had been working late dodged from column to column, using the latest in antimech warfare developments with devastating accuracy. Sooner than seems possible they were joined by one 'Mech, the Inner Sphere's most famous Battlemaster.

The First Prince's 'Mech is always kept in top condition at the Palace; it is evident that Prince Hanse is, also. Remember that not a dozen years ago, Hanse Davion was known as a top mechwarrior. He showed all his old skill tonight as he worked with Dr Banzai's impromptu forces, using the Liao 'Mechs against each other as only a lone fighter can do. At one point he fought both a Griffin and a Marauder, downing both 'Mechs and thereafter using the Marauder's ripped-off arm as a club. This gave time for the light 'Mechs from other recovering members of Team Banzai and warriors from the Hong Kong Cavaliers to reach the fight. Two team Banzai members were killed and one, Lt Kahil Holt, was badly wounded in this first exchange of fire. Dr Banzai then led the rest of his team around the campus of the NAIS to come in at the rear of the Commandos.

Riva Allard, PhD candidate, and Kym Sorenson, whom rumor considers the fiancée of Duke Morgan Hasek-Davion, took part in the guerilla fighting. Miss Sorenson is reported in grave condition. Team Banzai as a group is back in the hospital.

None of the commandos survived; all insisted on fighting to the death. They had almost reached their target, the NAIS's computer memory core, containing data forwarded by the Grey Death Legion from an old Star League facility, the AFFS Top Secret War Plans, and similar highly important data. The Death Commandos had been reliably reported on Kathil, where Duke Morgan Hasek-Davion's First Kathil Uhlans (the Lions of Davion) were known to be battling for the planet's geothermal stations. Identical Commando 'Mechs and mechwarriors have been reported sighted at both locations. When the war is over, scholars will have a field day puzzling this one out.

BattleTechnology News Service

Sarna Massacre?

June 1, 3029, Sarna, Sarna Commonality — or possibly, the Sarna March of the Federated Suns!

The Fifth Syrtis Fusiliers were hungry for Capellan blood after the death of their well-loved Duke, Michael Hasek-Davion. The Fifth's RCT under General Gordon Hartstone was in command of an operation involving the two regiments of the Crater Cobras, the second regiment of the Screaming Eagles and fifteen regiments of regulars, a highly important operation — the invasion of Sarna itself. The plan, as worked out by the Capellan Operations Command of the Federated Suns with General Hartstone assisting, had the combined units make three jumps, waiting to recharge in uninhabited systems, then landing in four locations on the continents of Jacarlos and Conoshal for a coordinated sweep.

As the units left the final jump point in their dropships, the Fusiliers' eagerness for battle overwhelmed their sense of responsibility to the

other units participating. Their ships accelerated at 2.5 G, leaving behind the other ships, who were restrained to 1.5 G. They also left behind a large percentage of their ammo resupply, which was being transported with the Cobras. This might not have mattered. The unit had a splendid combat record; General Hartstone expected to have two days to vent the Marcher Regiment's fury on Sarna before the other units could "get in on the fun." This might not have mattered — if Federated Sun's intelligence had been complete. Secretly, McCarron's Armored Cavalry, all four regiments of the Big Macs, had been relocated on Sarna. And they had a grudge of their own. Remember what the AFFS did to their second battalion six years ago? They came as a complete surprise to the Fusiliers. Between bloody ground battle and aerospace fighter strafing, the Fifth was cut to pieces. Of 132 'Mechs, 15 remained. Eight of the ten supporting regiments were annihilated.

The Cobras' and the Eagles' leaders met while in transit. Colonel Westrick, commander of the Cobras, came up with a daring massed strike. By the month's end the planet seemed destined for Davion hands. During those last days of the month the incident seems to have occurred where units from the Fusiliers devastated a ComStar facility. As it now stands, the planet still does not belong to the Federated Suns, the Fifth Syrtis Fusiliers has ceased to exist — and ComStar has placed an interdict against the Federated Suns. It is rumored that General Hartstone survived the battle in Liao hands, and that Prince Hanse has personally refused him ransom. Duke Morgan Hasek-Davion was unavailable for comment.

Lord Ridzik Slain

June 21, 3029, Elgin, Tikinov Free Republic

The perfumed candles of a lover's assignation had burnt down to their sockets in room 1145 of the Hotel Percheron; a man's dead body lay on the grey plush rug. This year saw Lord Ridzik leave his position as the Commander of the Capellan Confederation's military forces to declare the Tikinov Free Republic under the sponsorship of Prince Hanse Davion, and to become the ruler of that small but crucial area. (This did not include the planet Tikinov, which had earlier been captured by the AFFS. There had been speculation as to whether eventually this situation would cause a rift between Lord Ridzik and the First Prince.) Lt Gen Ardan Sortek, aide and liason to Lord Ridzik, remains at the helm of the Free Republic for the interim.

Further confusion: the vanished guest in whose name the room was rented, registered as "Beth Giordano". This was the pen name of Elizabeth Jordan Liao, second wife to Chancellor Maximilian Liao. The Chancellor's Lady has not been seen publicly since late last year. She was on poor terms with Romano Liao, Duchess of Highspire, the Chancellor's daughter by his first marriage.



The Macs Near Ruins, Commonality Hall of Commerce, Sarna

BattleTechnology News Service

Northwind

Board of Inquiry, May 12, 3029

Testimony of Lt Kahil Holt, Team Banzai

Prosecutor: Why did you follow the routed 'Mechs from the 36th Dieron Regulars?

Lt Holt: I felt it was necessary after the Highlanders arrived. We'd just found out about the Snakes poisoning the water supply for three civilian cities. We felt they needed a lesson.

Prosecutor: So you took it upon yourself to do a SADE (Search and Destroy Errand) after six 'Mechs?

Lt Holt: Well, not by myself. I had a Battlemaster from the Bravos and a couple of Highlander 'Mechs with me.

Prosecutor: That explains the extra three 'Mechs on that final battlefield. So why weren't there any survivors?

Lt Holt: Well, as each of their 'Mechs overheated, they sacrificed it to continue their attack on us. The same as later, when the Snake Warhammer turned to face me, I knew I'd have to overload my 'Mech if I wanted to take him out.

Prosecutor: What happened first?

Lt Holt: The other three 'Mechs went ahead to engage the enemy. I guess they were overconfident because the Highlander Archer and Vindicator engaged four of the six Snakes by themselves. The Bravo Battlemaster went looking for the other two, the big 'Mechs we'd detected earlier. I switched my sensors from Infrared to Magnetic Anomaly Detector. That showed the last two 'Mechs hidden on the Island in the small lake.

Prosecutor: I ask you again, Lt Holt, why there were no survivors?

Lt Holt: When I tried to contact my team, er, my transmitter was malfunctioning; I saw my comrades in arms getting wiped out. So I had to do my best to take out those murdering Snakes! After everything they did to the people of Cromarty! Bacterial warfare on civilians is forbidden by the Ares Convention! Doc Banzai, you know they blasted him! My friends were getting blown apart! You want to sit here and....

(Spectators' uproar drowns out recording)

Marik Quarr e l

June 18, 3029: Atreus, Free Worlds League

Outside the office of Captain-General Janos Marik two men almost came to blows today, two men each of whom has a right to consider that he himself may one day own that office. Duncan Marik, nephew to the Captain-General, and Duggan Marik, the oldest of his surviving sons, had an angry altercation over the use by Duggan of supplies which had been meant for Duncan's men. As neither man is commanding a force which is actually in the field at the moment, the bitterness of the argument seems excessive.

Duggan has been heard to criticize his father's slowness in following up on Operation Dagger. He argues that now if ever is the time to strike hard at the hated Lyran Commonwealth and to regain territory which is historically and culturally that of House Marik. Duncan agrees as to the necessity of regaining such alienated systems, but believes that a coordinated strike with Marik's ally under the Treaty of Kapteyn, House Kurita, would do more damage and reap more gains.

The Captain-General himself has preferred reaction to action. Since the end of the February-May Lull in the Fourth Succession War, the Free Worlds League has lost four worlds to invasion by the Tikinov Free Republic — and ceded eight more to the newly independent republic which used to belong to Marik's ally House Liao.

Thomas, youngest of the Captain-General's sons, home on a visit from the station where he has been a valued member of ComStar for over a decade refused comment on the ground that to do so would be inappropriate. BattleTechnology wonders... When the Captain-General decides to pass on his office, could ComStar possibly release the able Thomas for the task? He certainly wouldn't brawl in public corridors.

Marik 'Mech challenges Tikinov Lance



News From The Front

Kurita Slays Steiner!

The Stage is Set

from

BattleTechnology Weekly News, August 21, 3029:

Assassination Attempt on Katrina Steiner

—An Update

August 15, 3029 — Tharkad, Lyran Commonwealth

As our readers will recall, the Lyran Commonwealth owes a debt of gratitude to Misha Auburn which it can never repay. On June 20, Miss Auburn, daughter of court historian Thelos Auburn, foiled an assassination plot on the Archon's life. Three men wearing Davion Light Guard uniforms and carrying a well-faked message packet with the seals of Prince Hanse Davion and Quintus Allard, Minister of Information to the Federated Suns, bluffed their way past security checkpoints and into the Archon's waiting room. One of them claiming to have a personal message for Princess Melissa, was admitted to the Archon-Designate's rooms, where she and Miss Auburn were working the rehabilitation of war wounded. Miss Auburn is "keeping company" with Andrew Redburn, the commander of the Davion Light Guard's famous Delta Battalion. She recognized that the man was not wearing the St Andre Campaign ribbon and became suspicious. Miss Auburn managed to disable the assassin, to race to the Archon's rooms and enter calmly, to deceive, and then to disable the other two assassins. Neither the Archon nor Princess Melissa were harmed.

The paper and the wax of the packet were proved to come from the Federation of Skye. Sources loyal to Duke Aldo recently uncovered evidence that linked the assassins to Duke Frederick Steiner, close relative of the Archon and long-time seeker for her throne; the night before the attempt. Duke Frederick has been invited to an audience with the Archon next Tuesday. The Duke has not granted the press an interview.

Operation Contagion

Lord Theodore Kurita, over the last year of fighting, has showed himself an inventive and courageous general. It is due to his efforts that the Draconis Combine has effectively halted the Lyran Commonwealth's offensive. Our readers will remember that the Lyrans had originally intended a diversionary wave of attacks to keep the Combine from taking territory from Steiner's ally the Federated Suns while Davion

forces attacked Liao planets. As so much of the Dragon forces have been tied up in the Galedon system fighting Wolf's Dragoons, the Lyrans were more successful than they had expected, taking a dozen or more worlds. One of those worlds was Dromini VI, an agricultural planet which seemed of low priority.

Lyran manpower was thick all along the Draconis border. Dromini VI was now behind the first line of that border, and in a good position to be a springboard for a careful offensive. There was still a deepfelt civilian sentiment for the Combine, though formal resistance had ceased. Early in August a squad of Nekekami attacked and killed or captured all of the planet's garrison, two infantry companies from Barret's Fusiliers. They wore the uniforms and took the places of the soldiers they had captured, using the Commonwealth codes and imitating their regular signals. A few days later they were joined by the Genyosha, the 3rd Dieron Regulars, the 17th Benjamin Regulars, and the 2nd and 14th Legions of Vega. Guarded by these units, *Tai-sa* Kurita began to stockpile massive amounts of supplies for an invasion in force. By September 7, the supplies were ready, six jumpships were loading on planet, several of the regiments had left for prepared pre-invasion positions, and the *Tai-sa's* invasion was ready to begin. On September 12, incoming jumpships were sighted at nonstandard jump points. As their dropships began an inbound run to the planet he held, *Tai-sa* Kurita ordered his troops into a series of almost unbreakable rings around the warehouse city of Kanashimi.

The duel begins

At his interview with the Archon, Duke Frederick was evidently offered a chance for an honorable death. At the head of his 10th Lyran Guard Regiment he led a volunteer mission to destroy the supplies for *Tai-sa* Kurita's invasion. He bypassed the *Tai-sa's* rings and left behind any chance of a safe withdrawal by dropping his 'Mechs directly onto the city. The 'Mechs worked havoc among the warehouses; when Combine 'Mechs were pulled back from the outer defenses to engage them, the Lyrans fought to destroy and disable, not to win and escape. Once the tide of this unequal battle began to turn, Duke Frederick offered an unusual surrender. He would turn himself over to *Tai-sa* Kurita in exchange for the permitted escape of his troops. Prince Theodore agreed.

A meeting followed between the two men, a meeting

**Dateline: Dromini IV
1030 Hours Local Time,
September 13, 3029**

which has all the stuff of classic drama. At first Duke Frederick was treated with all due courtesy as an honorable enemy in defeat. The two rulers sat together and drank wine while *Tai-sa* Kurita informed the Duke that only a few tons of supplies had been lost. Then he received word that several teams of Loki (Steiner Elite Commandos), masquerading as the Duke's jumpship crewmen, had attacked the Combine's invasion fleet, crippling the six loading jumpships. Without transport for his supplies, the *Tai-sa's* invasion was doomed. Enraged by this evidence of Lyran treachery, it seems that Lord Theodore shot and killed Duke Frederick. It is confirmed that a shot was fired, and the Duke's body was shortly thereafter removed on a stretcher. Funeral arrangements for the Duke were not made public.

The Duke's successor, Lord Ryan Steiner, has announced a memorial service for the date of October 5, 3029, which would have been the twenty fifth anniversary of Duke Frederick's accession to his Dukedom.



Tai-sa Kurita in the field, March 3029. We regret no recent picture of Duke Frederick was available.

News From The Front

Guerillas on Glenmora!

Shrieking hoverfans shattered the early morning stillness as Bravo Company, 1st Battalion, 1st Hovertank Regiment, Fifth Deneb Light Cavalry, came home after a night on the prowl. The unit is nicknamed the "Barracudas." Tonight the unit lived up to its nickname, for the hunting was good. Carbon scoring and numerous dents attested to heavy fighting but all the company's vehicles returned home intact. No casualties were reported among the crews, and the men were in high spirits. Several hovertanks sported kill rings and silhouettes, with new ones being painted on as we watched. After the unit bedded down for the night, I was able to interview the unit's commander.

"Yeah, we caught 'em napping", stated Captain Lawrence Haik. "They're so busy stompin' around after the Dragoons that the Snakes aren't paying much attention to us small fry. Well we taught 'em a lesson in deep penetration raids tonight."

While the Captain refused to go into the details of the raid, citing security concerns, it was clear from the information he did reveal that a major Kurita ammunition supply point has been destroyed, as well as the maintenance collection point for a 'Mech battalion. Several Kurita 'Mechs were destroyed, in addition to numerous vehicles, tons of ammunition, and other supplies. This raid is expected to stall this portion of the Kurita drive on Glenmora for at least two weeks.

The Glenmora campaign began over six months ago with the arrival of Alpha Regiment, Wolf's Dragoons, in late August 3028. The regiment, like all the other units of that enigmatic mercenary outfit, has been incognito since leaving Harrow's Sun for Glenmora in mid-August. While the departure of the regiments to their assigned duty stations was highly publicized, their subsequent actions have been conducted under their usual veil of secrecy. No interviews have been allowed with unit personnel and all attempts at close range photography of the unit have been interfered with. Reports from other sources indicate that Alpha Regiment has been in combat with the Kurita troops since the Fifth Galedon Regulars landed on Glenmora on September 18, 3028.

Since early March, the campaign on Glenmora has

evolved from full-scale pitched battles to a hit and run guerilla war. Colonel Wolf has broken his units down into company size or smaller teams. Alone or in conjunction with units of the Tenth Deneb Light Cavalry, these teams have played havoc with the slower and heavier Kurita units. A key part of this strategy has been to concentrate the attention of the Fifth and the Sixteenth Galedon Regulars on Wolf's Dragoons, allowing the units of the Tenth Deneb to raid the enemy's rear and flanks. So far the strategy seems to be working. The enemy has suffered heavy losses, although his ability and will to continue the campaign seem unchanged.

So far all attempts at gaining interviews with Wolf's Dragoons personnel on the current status of operations have been unsuccessful. From what information we can gather, however, the Dragoons appear to be fighting hard, Heavy losses have been reported and battle damage is obvious on long-range photographs. But the unit's fighting spirit and almost demonic need for vengeance against their Kurita adversary seems unquenched. There are reports and allegations of atrocities on both sides. This appears to be a fight to the finish. Who the victor will be is not clear at the moment.

As usual, there are numerous stories concerning the Black Widow, Captain Natasha Kerensky, and her infamous Black Widow Company. Earlier in the campaign, her unit was credited with destruction of a Mobile headquarters, along with the destruction of a company's worth of Combine 'Mechs. The Draconis Combine press liaison officer on-planet strenuously denied these reports, calling them "base lies spread by an enemy who has no honor." The Black Widow Company's current whereabouts are unknown. It is said to be conducting one of its usual rear area rampages.

Earlier this evening I was able to interview Colonel Carla Kearns, the commander of the First Hovertank Regiment, Tenth Deneb Light Cavalry. I asked Colonel Kearns to comment on the campaign in general and current operations in particular.

"Well, as you know, Glenmora is a rather unique campaign. It's actually part of three separate battles going on on the planets of Harrow's Sun, Wapakoneta, and Glenmora. This campaign is more a blood feud between Wolf's Dragoons and

Dateline: Glenmora, 0530 Hours Local Time, 29 March 3029

Takashi Kurita than a fight between the Federated Suns and the Draconis Combine. I'm not sure of the details, but something happened in the Draconis Combine, something really bad. The Dragoon officers I talked with wouldn't comment on the incident except to say they were determined to carry the fight to the finish."

"I've never seen two adversaries push themselves and each other so hard. They're totally committed to the other's annihilation and damn the cost, no matter how high. I'm just glad that it's the Kuritists they're mad at and not us." the Colonel said in a low voice. Then she shuddered. "It's almost spooky, this fight. I don't know how it'll end."

The Colonel paused, reflecting for a moment, then moved to describe the current situation.

"Now, as you know, I can't comment on specific unit deployments or other operational matters, but I can give your readers an overview of the current situation. The Tenth Deneb's arrival in mid-December changed the complexion of the Glenmora campaign. Previously, both sides had few conventional troops and were forced to conduct pure 'Mech operations. While relatively easy to plan and support, this type of combat places limits on a creative commander, especially one like Colonel Wolf."

"Since assuming command of both units after the death of Marshal Sanders (Commander of the Tenth Deneb), Colonel Wolf has melded Alpha Regiment and the Tenth Deneb into an effective combined-arms team. In early March he implemented a plan to tie down large number of Combine 'Mechs while increasing the survivability of his own forces. Replacing standard company and battalion units with mobile hunter-killer teams of 'Mechs, vehicles, and infantry, Colonel Wolf has given us the creative tactical edge. We now have the means to combat the enemy in a variety of ways, on ground of our own choosing.

"Mobile operations began on 5 March with the 1st and 2nd Hovertank Regiments conducting a large scale raid on the Kurita rear area. The destruction and confusion caused by this action marked the breakout of Wolf's Dragoons and the Tenth Deneb from the Tronka perimeter. Within the past month units have scattered across the entire face of the Hades continent. We are engaging the enemy whenever and wherever a favorable opportunity arises and we'll continue to do so for as long as necessary."

I asked Colonel Kearns how long she expected this phase of the operation to last. She looked at the map and consid-

ered the question.

"That depends on a number of factors. Provided no further reinforcements arrive for either side, this type of campaign could last for months. I can't see it lasting past the summer though, because by then both sides' vehicles and personnel will be too worn out to continue. But with this blood feud between Wolf's Dragoons and House Kurita, who can tell? I'll just be glad when it's over."

Following that, the Colonel and I concluded the interview and I departed the regimental headquarters. While the Davion defenders appear to be holding their own at the moment, this campaign is unpredictable and anything could happen. The future will determine whether Glenmora will remain part of the Federated Suns, or fall under the iron yoke of the Dragon. As for Wolf's Dragoons, we can only hope they achieve their goals with a minimum of loss. This war has seen more than its share of casualties.

Bravo Company hovertank in action



News From The *HOME* Front

Silence and Spirit

On June 1, 3029, all the worlds know that ComStar placed an interdict on House Davion. No messages, no calls, no communication of any sort. No Davion world, no Davion Ambassador, consul, or commander on another planet or in space; nobody owing loyalty to the Federated Suns could place or receive communication. Prayers were chanted; receiver dishes were turned ceremonially away as the precentors conducted shunning rituals. And the silence began.

The interdict has to have had profound effects on the Federated Suns. Has it affected the war, or brought it to an end? Has it caused the expected strained relations with the Lyran Commonwealth? What has been its effect on civilian personnel? Let us take these questions in order.

The war is not over, largely because of the unique structure of the Armed Forces of the Federated Suns. For the last several years, even before the first Operation Galahad (the one which was pure military exercise, and fooled other Houses into believing that last year's would be also), the AFFS has stressed self-sufficiency. Each Regimental Combat Team (RCT) has been designed and trained to operate independent of headquarters control. Although a message from headquarters takes a week by "Pony Express", as the Davions call the jumpship relay, an RCT is ready at any time to make and carry out military policy on a local level. Though strategy is for the High Command, tactics are largely left to the leaders in the field. This makes for both flexibility and independence. *Push mind and body before you call for help* was the unofficial motto of Operation Galahad. The new COC, the Capellan Operations Command is headed by five marshals. Technically the highest officers in Operation Rat, the fourth and fifth invasion waves, these men are in charge of supply, information, and transport. Not policy. Four of these five were set, while the fifth member seems to be filled by a series of able men and women shuttling back and forth from the front to COC headquarters (the location of which is Ultra Top Secret) to New Avalon. If this pattern was useful before the Interdict, think how productive it must be now. Incredibly, the war effort of House Davion seems to continue full steam.

The Federated Suns and their ally the Lyran Commonwealth had practiced a series of Disaster Scenario Policy Formations. The contents of these had been secret until the war began; BattleTechnology has respected that se-

crecy until now. When one sees an entire city's population begin to carry two day's emergency rations with them, or on Northwind, to carry a water test kit, one knows that prior planning must have been systematic and impressive. One of them must have been meant to deal with interruption of communications; there is no other way to explain the coordinated way that merchant transactions resumed after the first few weeks of chaos. Steiner forces ceased their offensive against the Draconis Combine, it's true, but only in order to take up previously set positions to guard and consolidate the Terran Corridor which links the two Houses physically. Distressed citizens from the Federated Suns receive a hearty welcome anywhere in the Commonwealth except in the worlds of the Tamar Pact. Even there, official policy gives some relief, though the prevailing attitude holds rumblings of rebellion against the war. It is no secret that the Isle of Skye thinks it would do well as an independent state. The situation is eased by the fact that Lyran merchants everywhere, from the White Hart Truffle Company to the company releasing the popular dramavid *On The Run*, were selling in quantity to House Davion for its luxury lotteries. *Where business goes, friendship follows*, states an old Commonwealth proverb.

On the civilian front, the problems came in two varieties. The emotional effects of the Interdict on some of the less technically advanced planets were sorrow and confusion. Their Church and their Prince seemed to them to be at war. On the planet of Des Arc, Precentor Nicholas Frent's inflammatory speeches led to a riot where two hundred and sixty people were murdered. Religious riots on twenty other worlds had less violent affects. House Davion broadcast pleas to everyone to view ComStar's video of the raid on its facility on Sarna which was the cause of the Interdict, and to make up their own minds. Interestingly, on every world which allowed widespread distribution of the film rioting ceased.

Shortages and therefore crimes involving ration books, the so-called "Davion Debt Books", were increasingly common. The emergency network for food distribution soon got underway, with most people most of the time receiving the basic necessities. Still people grumbled and stole — until the Luxury Lotteries got underway. Newspapers published the daily and weekly winners. Nothing was too small to be auctioned — a box of candy, a pound of coffee, an autographed biography of a star. Civilian morale, bolstered by the lotteries, was farther raised when it became apparent that all ships which could be spared from the war and supply fronts

**Dateline: New Avalon
September 1, 3029**

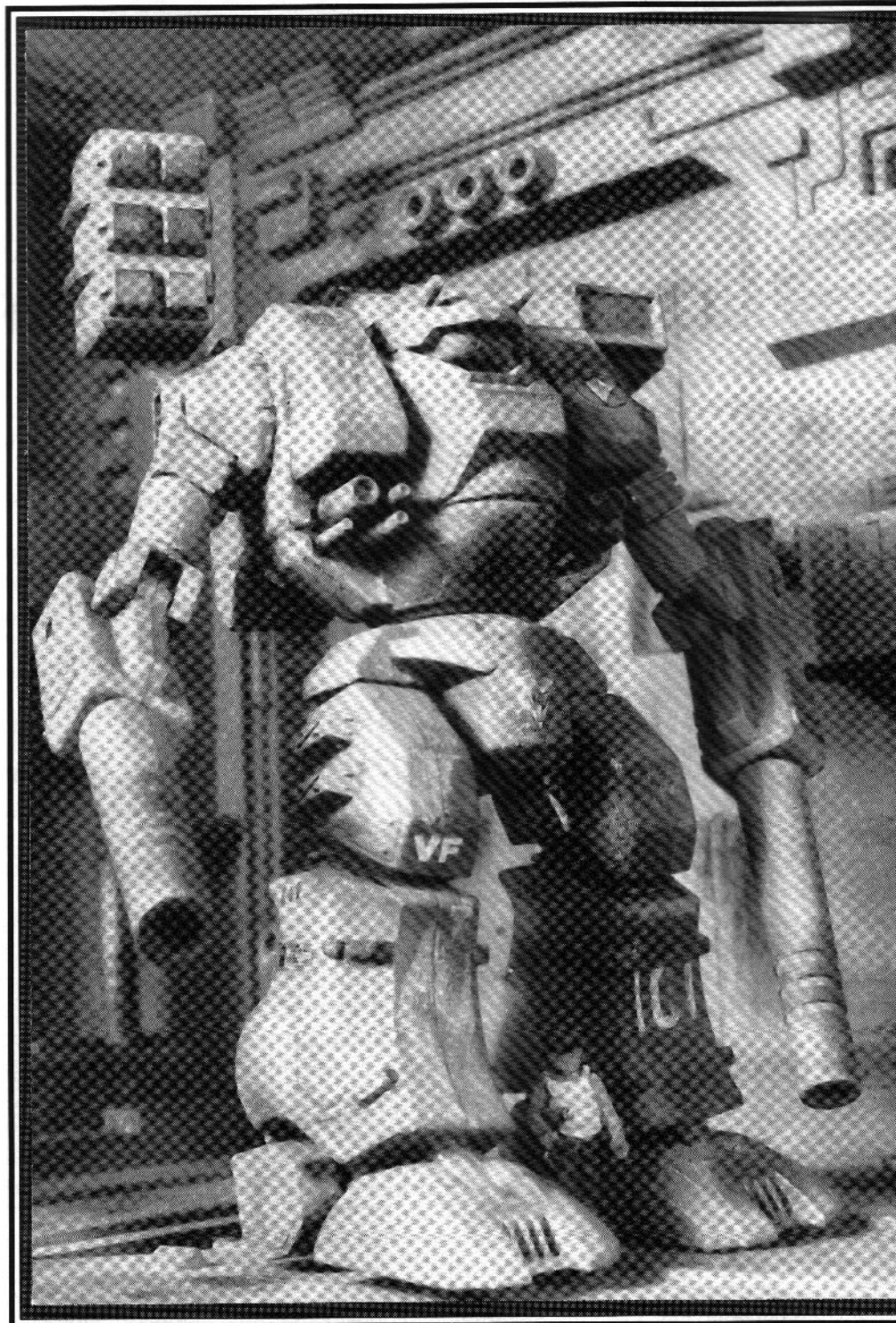

He's

**W
A
I
T
I
N
G**

FOR

YOUR

LETTER

— YOU'RE HIS

REAL

**GROUND
SUPPORT!**

This picture appeared in major newspapers across the Federated Suns

had been diverted to the carrying of mail. Literacy has been taught and treasured in the Federated Suns for the last three reigns, but in response to this challenge citizens took it up almost as a hobby. Letterwriting became a popular art again; contests were sponsored by companies as diverse as Melcher Meat and Federated-Boeing. Skilled propaganda encouraged this new fad.

Three months after the Interdict, this seems to be its effect: the Federated Suns is more determined than ever to wage and win the Fourth Succession War.

September 3029

BattleTechnology 11

Who Can Know A Man?

In Memoriam: Michael Haskek-Davion, Duke of New Syrtis

by Lee Preston

Our Duke, Michael George Hasek-Davion, was a man larger than life. As with others made in this heroic mold, Duke Michael was contradictory, even self-contradictory.

He was a man of pride who died humbly.

He was a man of war who died suing for peace.

He was a man who loved his family, yet spent the last decade apart from his only son.

He was a man who liked simple statements of fact, yet he died leaving behind him an enormous question...

Michael George Hasek was born on April 2, 2976 in the University city of Saso on New Syrtis. His father, George, Duke of New Syrtis, was the staunch friend and ally of Prince Andrew Davion. This threw his young son into the company of the two Davion princelings, Prince Ian and Prince Hanse, as he was growing up. It is natural that a warm friendship sprang up between Prince Ian and the young duke-to-be. They were men who were much of a kind, men of war, and proud of it. Each had a distrust of the negotiator's table and the territory often lost there to cleverer tongues. Young Michael had as quick an intelligence as either of the princes, but the premium placed on hearty masculinity by Duke George and Prince Andrew made him determined to hide his ready wits. It is not the least tragedy of our times that the younger of his royal schoolfellows recognized the intelligence and the concealment, but did not find the reasons for either in his own troubled psyche. In plain language, the heir to the proud tradition of the Haseks and the younger son of House Davion never got along. Prince Hanse as a younger man seemed jealous of Michael Hasek. This jealousy was to lead him to unworthy suspicion.

When in 3003 Michael fell under the spell of Marie Laura Sinclair-Davion, Prince Hanse's half sister, and courted her for his wife, Prince Hanse suspected him of seeking not the lady but a link to the throne. Duke Michael and his bride left New Avalon for the Capellan Marches. The Duchess never saw her father again. It shows the depth of his love for the mother of his son that Duke Michael, after all these insults, joined her name to his own, and styled himself "Hasek-Davion".

The people of the Capellan Marches understood the impe-

rialist ambitions of the Capellan Confederation much earlier than the rest of the Federated Suns could have; after all, we're their neighbors. It's hard to hide your flaws from people who can look over the back fence. We saw our people shot down in "accidental misunderstandings". We saw "survey parties" inadequately disguised as they licked hungry lips mentally dividing our home systems for their future colonies.

As a serious historian of the Marches (*Action & Reaction; The Purge of the Syrtis Fusiliers*, Vintage Press, Halcon, 3002; *Pleides to Pirates' Haven, the Marches' Relations with the Periphery*, University of Saso Press, 3007; *The Indian Peoples of the Marches*, University of Saso Press, 3010). Duke Michael spoke out early in Prince Ian's reign against the incursions of Confederation forces. The Davion monomania against House Kurita caused his warnings to go unheard. As the two Davion princes ravaged the Draconis March to pursue their preferred foe, Duke Michael in his post as Minister of Intelligence, Investigation, and Operations kept up a constant struggle to keep information and supplies moving to the shifting front. He and his wife moved in the top circles of Federated Suns government; these were the golden years, as part of the trusted elite.

With Prince Ian's death, the story changed. Prince Hanse's policy toward Duke Michael can only be described as a "freeze-out". There was an assassination attempt on Prince Hanse even before his coronation. The new First Prince blamed the Ministry for not preventing the attempt; the Minister, Duke Michael, was dismissed from his post in 3015. Prince Hanse's surprising decision to court the Capellans, repudiating old alliances, further weakened the relationship between the two heads of state. Duke Michael withdrew to New Syrtis, ably shepherding affairs as Minister of the Capellan March, a position he retained until his death.

Despite repeated demonstrations both of his loyalty and his ability, Duke Michael would never hold central government office again. Nor would his efforts be recognized or supported by the government; supplies to troops in the Marches have arrived later and later; some have never arrived at all. Duke Michael dealt with the shortages and quietly reaffirmed his loyalty. Prince Hanse demanded — suavely — the presence of Baron Morgan Hasek-Davion, the ducal couple's only son, at court as a permanent guest. As the young MechWarrior grew from a gawky young man to an heir to be proud of, he



Duke Michael in an informal moment, Saso Historians Guild Meeting, November 3028

found himself far from a father's love. The most recent visit the two men had was at the famous wedding, where Captain Morgan Hasek-Davion acted as best man. It is an irony that if Prince Hanse has no children, Duke Morgan will be his successor.

Over the last several years, Prince Hanse has at last come to understand the danger posed by the insane ambitions of Chancellor Liao. One would think that the war now declared and raging between the two Houses would demand the fuller use of Duke Michael's talents, but they were not called upon. Duke Michael remained in his civilian post during the entirety of Operation Galahad and the events which stemmed from it.

Duke Michael was an able fighting man, a noted historian, and a shrewd judge of character. Yet the facts are these. On, February 13, 3029, Duke Michael secretly boarded a Drop-Ship and was smuggled outsystem to Sian, capital world of the Capellan Confederation. There he sought an interview with Chancellor Maximilian Liao, his lifelong enemy. During that interview, he was shot and killed. It seems that he had taken this desperate despairing chance to sue for peace in our behalf; he felt that the March could not survive. How could he have so distrusted us, his loyal people? We have fought in us we have not begun to show! How could this shrewd and able statesman have possibly thought he could trust the word of Chancellor Liao, should he obtain a peace agreement?

Last week we received his body for burial, with an escort of traitors to mock him. Today we bury our Duke. The mistakes he made — let them be buried with him; the good that he did will long live after him.

So will the questions.

Lee Preston studied journalism here on New Syrtis before joining the staff of J'Accuse on Robinson. He wrote for six years for this well-known compendium of counterculture and music before joining the staff of the Saso Clarion. This article is reprinted from the Clarion's special memorial to Duke Michael.

Duke Michael's son, our Duke Morgan Hasek-Davion, is en route to his father's funeral.

The editors and staff of the Clarion wish to extend our sympathy to Duke Morgan in his grievous loss.

We mourn with you.

Interviews in Brief

"My great-nephew died as he has lived. I can say no stronger praise than that. He has always had a special love for his people of the Capellan March." *A slight smile.* "We've always been a little too wild for the civilized people of the central suns. You know, the ones who have to be taught to fight because their parents don't teach 'em young! It's not in their blood. Well, it was in Michael's. He never forgot that a Hasek must fight for what he holds."

*Marshal Tamara Hasek, Commander
Fifth Syrtis Fusiliers*

"In the war which we have begun with the Capellans, they have killed one of the greatest leaders the Federated Suns has ever had. Now we must give no quarter. We have lost his wisdom and his leadership, but we must go on."

*Zared Tikko, New Syrtis Regional Manager
Mendham Electronics*

"The graduating class asked to be allowed to volunteer for the Syrtis Fusiliers; we're certain that they will be seeing action soon against those Capellan...troops. I'm proud to say that every one of them volunteered. My personal feelings are not for public record."

*Col Kathleen Sullivan Commandant,
Warrior's Hall Military Academy*

"He went on a great mission. We see how those Liao women-stealing, ideologically destroying baby killers react to his nobility. We'll see the Fusiliers revenge his death." *Yosif Aman, graduating class, Warrior's Hall newly joined the Fifth Syrtis*

"Duchess Marie has taken her private light aircraft into the Redrock Mountains east of the ghost town of Lady's Favor. There is a small hunting lodge there which the ducal couple have often used when they wanted to be alone. She asks to be left undisturbed until she can come to terms with the manner of her husband's death."

Lady Zarabeth Morgan,

First Lady in Waiting to Duchess Marie.

"There will never be another like Duke Michael. He was a man you felt proud to follow. When I think of those Backstabbers taking him down like that, when he'd gone there for a peace treaty, I can't stand it. He will be avenged. We'll paint our 'Mechs with Capellan Blood!"

*Mechwarrior Tybalt Hadas
Fifth Syrtis Fusiliers*

BATTLETECHNIC

The Ultimate Force behind your combat readiness!

Yes, BattleTechnic has it all!

BUY! ○ SELL! ○ TRADE!

*BattleMechs

*Firearms

*Ammunition

*Battlefield salvage

*Vehicles

*Aircraft

*Uniforms

*Electronics

*Manuals

*Simulators

*Dropships

*Military surplus gear

AND MUCH, MUCH MORE!

* Your outlet for low-priced military equipment!

* We buy your battlefield salvage, at the best prices going!

* We sell you fully-serviced combat gear!

* Every item backed by our unconditional guarantee!

BATTLETECHNIC:

CONVENIENT LOCATIONS ACROSS THE GALAXY!

All equipment absolutely guaranteed 15 days from date of purchase. Combat or other heavy use may void guarantee unless otherwise stipulated in writing by original manufacturer within 10 days of purchase. BattleTechnic disclaims all liability written or implied for all items manufactured or salvaged. Battlefield salvage subject to all legal restrictions and taxes where required by law or military authorities. Prices and availability will vary from world to world. Prices and availability subject to change without notice.



Blood

on the

Snow

Standing in the offices of BattleTechnology, the mechwarrior holds a small black object, a TekCom Mk II battlerecorder. It is scratched; a corner is crumpled; there is a suspicious dark stain along the ID plate.

"I took it off the body of a hostile, one of the militia on Second Try. Her unit took out one of our 'Mechs. My Hatchetman was down for two weeks while the Techs looked for parts. I thought I was going to be one of the Dispossessed. Marcel's Stinger? He got its foot caught in the Pack Rat wreckage. It was burning and he couldn't get loose. Kept going into heat shutdown, over and over. I almost froze before he made pickup."

"The way I said, I salvaged this off her body. Sort of a trophy. I got somebody to translate. Thought I'd play it for the guys to show them what a hero I was. But now I don't sleep. I keep hearing her voice. If I gave it to you, I thought maybe... Maybe you'd print it. She wanted to tell her story. You know, they kept us fighting for more than two months. Brave people. Hope they work into the Federated Suns all right. Print her story. Then I can stop listening."

He presses the switch. The charge light flickers. Her weary voice speaks out, with its stumbles and pauses. How vulnerable she sounds, this dying enemy...

I wonder what it's like to be warm enough? In stories from other worlds they talk about summer, a season where people go outside barefoot and get heat stroke in the sun's heat. Here on Second Try, summer is the season where you can work out of doors without gloves. After six hundred years on the planet we still double-wall our buildings and insulate our doors. We wear layer on practical layer of air-trapping clothing. Our homes are dark with weather sealant, and heatsaver paint; however bright and cozy we make them inside.

I do wonder what it's like to be really warm. In every group of people there are those who like to work in just a therm suit, and those who buy the warmest coats they can; the window openers and the ones who want the heat turned up. I'm always the one in the pictures wearing gloves and a big hat. I'm always cold.

That makes it ironic that I choose

militia duty for my service obligation. Militia get the jobs that are too unrewarding, too troublesome for warrior units. We drill — gods, how much we drill — in castoff uniforms (read thin), with outmoded weapons (which we spend a lot of time repairing). We stand-to for defense of the planet when the glamor regiments are in ceremonial attendance on the Chancellor's Envoy or having fun at fleet maneuvers. We're the objects of the humor programs on the vids. We are to regular infantry what regular infantry are to MechWarriors. Target practice. We get civilian rations to do military tasks. Sometimes in the spring they draft us for dam maintenance. Sometimes in the fall we police the shipments of harvest fleeces. I don't even want to talk about what we do in winter — but we get all caught up on creative griping. Do you see what all these jobs have in common? They all happen out of doors. In the slush. In the wind. In the cold.

Second Tryers take a long time to think things through. It's a planetary

characteristic. The first try is just to get the heft of the job. The First Try at settling this world saw all but one family die out before the relief expedition arrived. But the First Families had mapped, had documented, had done mineral surveys — lots of pretty rocks, but that's all — they'd done the slow exploratory work in sufficient detail so that their relatives on the second ship could make a go of it. Second Try isn't an easy place. I wouldn't live anywhere else. I love the beauty of my world, from the Everice mountains on Deepsnow, the south continent; across the Windy Sea, to the glaciated tips of North Glacier. I love the tough people who live here, who sing as well as they fight, and do both at a moment's notice. I'm proud of our libraries, our ice festivals, even the silly meta-sheep whose thick wool is our principal export. I'll admit that nine years in ten nothing happens here. I suppose it's somehow my fault that I joined the militia just in time for a tenth year.

I can't remember ever being this

cold. And I can't seem to move. Guess I'll have to spill it all into my battle recorder and clean it up later for the report.

When I was a kid I listened to Granpa tell stories about the Third Succession War. I used to tease him for stories. He always obliged, but he got a pinched expression sometimes when he mentally returned to past hardships. Now I'm seeing the same expression in the mirror. The old curse goes "may you live in interesting times!" I wouldn't wish it on my worst enemy.

Our little world is being invaded; fought over by two of the great Successor Houses. Our old master, House Liao, left the planet stripped of troops. The militia was to hold in the unlikely event of an invasion. Nobody told the Feds they were unlikely. We have fifteen companies of militia, armed personnel carriers, scout vehicles, a sprinkling of tanks. We had twentyodd 'Mechs on planet, not counting pelagiculture specials (the fancy word for sea-farmers). We used to have aerospace fighters; they must be gone by now.

I never realized just how fragile a human body is until I saw one that had been stepped on by a "light"

'Mech... *Melancholy thoughts are the warrior's bane.* Besides, if you cry out here your lashes freeze.

Our Chancellor gave us the honor of holding this world; we've held it now for a month and a half; forty seven days. Our vid station broadcasts the day count above their logo at station breaks. When you go for medical attention you get treated like heroes; too bad there's no time for R&R! The town would be ours! I'd like to be treated like a hero, just for a few days. I'd like to go home again. Just for *one* day. I'd like to taste my mom's darkapple turnovers again — if she's home to do any baking! Mom's on a fire control team these days. We've all got our worries and stories. Look at those dreadful gloves Hogan's sister knitted for him. They're yellow and purple; we used to tease him about them, till the sister went missing after a raid. We don't think about winning any more; we sure don't think about losing! We just want to spit in their eyes for one more day.

Take today. We started out as a squad of sixteen, with two Pack Rats and our pride and joy, the Patton. It's a sixty five ton tank from a Lyran company, Defiance Industries. Heaven only knows how it got here; what with the arms embargo and all. It's got a quiet fu-

engine, a ten-round autocannon, a small laser, a five-rack of long range missiles, and a rear mounted flamer for surprises. It's got more armor than most light 'Mechs. The crew swear it handles like a private car! It's seen action twice, but only the paint shows damage. I swear, with twenty of them we could hold the planet. Could have held the planet.

Today's plan had the Pack Rats out taking a "lunch break" on a long stretch of road between the Sharpstone foothills and the winding ravines of the Backbreaks. What they were really doing was trolling for foolhardy 'Mech-Warriors, using themselves as bait. If air cover spotted them, and something less than a full lance came after them, they'd dawdle up the road looking stupid, keeping just ahead of the 'Mechs, then they'd pull off the road just past our prepared positions and we'd give the AFFS a surprise.

Once the Patton was in position, we had four hours to wait, longer if the Pack Rats didn't attract attention on their first fishing expedition. It took a couple of hours to build up the slope of the hummock with rock and snow so that the tank was hidden behind the

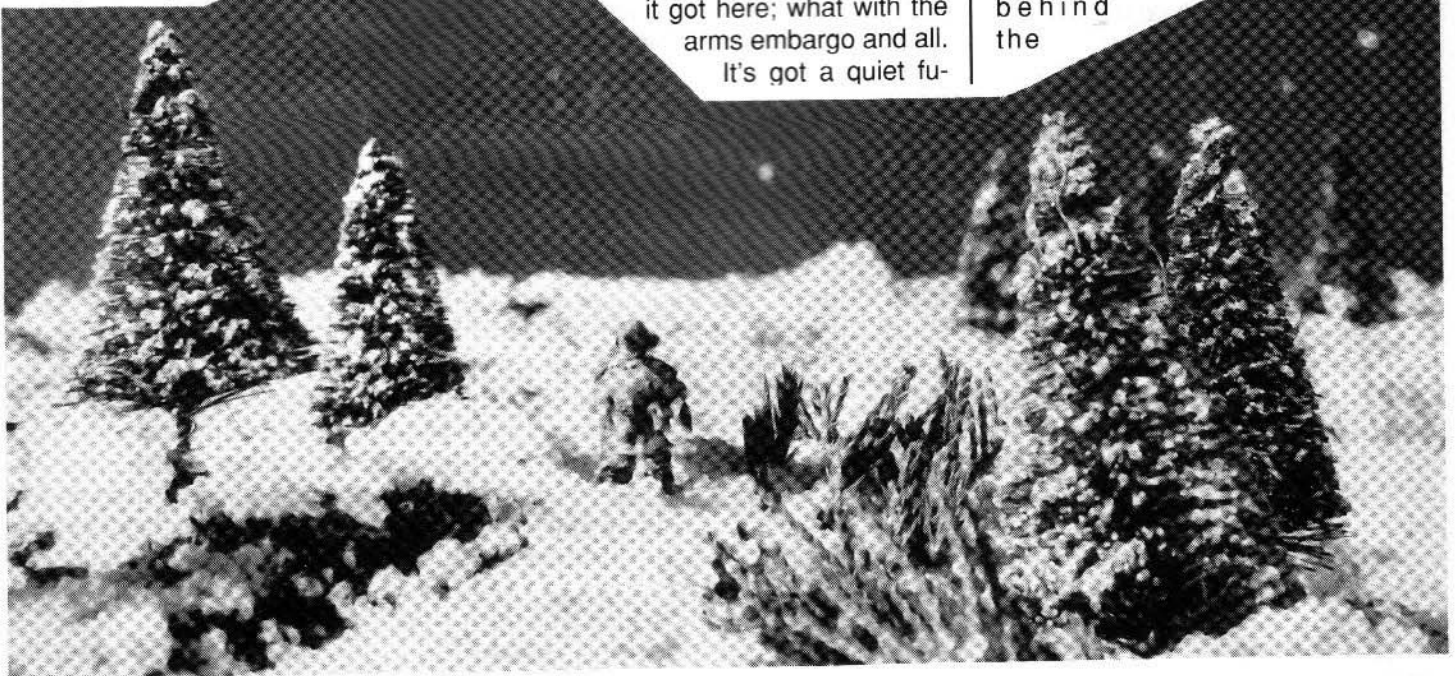

crest of the little hill. As we finished there was a short snowfall, fifteen minutes of soft lazy flakes that covered our work artistically. Thompson broke out in a whoop at the picture it made, "Pretty as a SUNDAY POST cover. All it needs is the snowman!"

Somebody began to laugh. Hogan, who hadn't smiled since Week One of the invasion. He started with a snicker, repeated it, worked up to a chuckle, built to a roar, and ended up in a snowbank on the far side of the Patton holding his sides to keep from laughing any more. Chang caught it next, then I did, laughing and hiccuping like maniacs. Then darned if Thompson and Jow didn't start *building* a snowman! Right behind the Patton on the rear slope, packing together armfuls of snow and rolling them into a huge ball for the base. Anderson and Chang, not to be outdone, rolled up another ball for the torso. Pretty soon we were all working away at it, except for Frances and Jessop who were tossing snowballs at everything in sight including each other.

It was a fine snowman. We found some round black rocks for the mouth; it gave him a charming smile. His head tilted just a little to the side as if he were inspecting the rocks behind the Patton. Hogan was just snapping a picture when the radio startled us. "Ssu-ma, Huang, Oley! Come home to lunch."

Victor dived for the codebook.

"Stinger, Hatchetman, Ostscout! Pursuing at full speed!"

The mood changed abruptly. Jessop let his hand drop to his side, releasing its snowball back to the frozen ground. He seized up his rifle and started to jog through the snow. We were all on the move. The half-squads circled wide, in where the broken rockfall would conceal their footprints. We settled in to our prepared positions, a klick down the road. I looked at Hogan. His face was buried in his scarf. He'd already started that slow exhalation you use in ambush training, the one that keeps your breath from pluming out in the cold air. We waited.

We breathed slowly. We didn't move; snow settled on our combat suits; good, it would bring down our reading to heat sensors. Suit heaters?

You must be kidding! We felt our toes tingle, turn icy, lose sensation. *OK, hero, I thought to myself. Why do you always have to be cold? Some people manage to defy death in deserts.*

Some people complain about never getting outdoors. You have to join the militia, where your nose never has a chance to stop running!

Frances pantomimed falling asleep. I wondered if Jeffers really was asleep. He seemed so still, so placid. Was I the only one who was keyed up? Chang cleared his throat nervously; I felt better.

It's like hearing with the back of your head, waiting for 'Mechs. You aren't even aware you're hearing them. There's a steady beat, like a slow pulse; you feel it before you hear it. Then it gets louder, and you realize that it isn't your heart; it's 20-plus tons of plasteel and ferrocrete looking to step on you and squash you like a bug. *What did the Locust say to the infantryman? Squirp!* Radio silence was strict, but I don't think there'd have been much chattering anyway. All that talking the city stations had been doing about "our brave militia" came back to me. I wasn't brave. The other guys, they were the brave ones. I knew I didn't belong there, but if I ran away everybody would see that my knees were shaking. So I stayed.

Hogan had this grin on that he

always gets before combat. I told you about his sister, remember? Chang was pale as you can get; his eyes were huge. I wondered what I looked like. The footsteps were thunderous now. I could have shouted and nobody would have heard. We saw it go past us; we

hunkered even closer into the snow. A Stinger! I could smell coolant as it went by. More footfalls.

Thud
Thud
passing us. Triangular head, right arm squared off like...it was a Hatchet-

man! What would the Davions throw at us next? The last 'Mech was straight out of the recognition manuals — an Ostscout. As it stepped on by us, so closed I saw rust on its hip actuators, I began counting silently, wiggling my toes inside my boots to get my feet ready.

"...And twenty! MOVE IT!" Hogan reared back and threw his grenade. We all opened fire, both sides of the road at once, pouring it all into the less-armored back of the 'Mech. Further up, I saw the Pack Rats had left the road simultaneously, circling around the pair of hummocks. The Stinger was pursuing one of them; the Hatchetman was angling around it for a clear shot!

WHUMMPH! The Ostscout got its shot off first, half turning into the center of the Sergeant's eight men. I closed my eyes against the sight. There was rock everywhere like rain, and something with it that was warmer. I opened my eyes to see our side of the road battered and bloodspattered. The other side was just a crater, a hole where the men had been. I leveled my rifle. Frances and Jeffers got off our SRM shot, into the rusty place on the actuator! It took two long steps toward us, tottered and fell. It seemed to fall for a long time, getting larger till it filled the

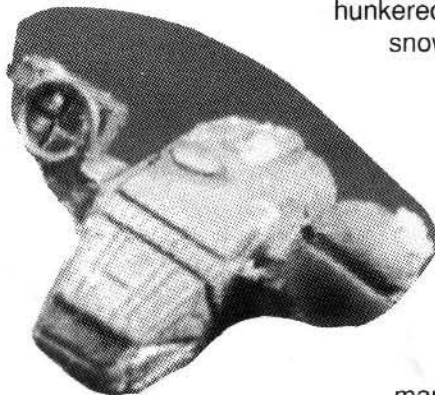

sky. It was falling toward us. We were scrambling up the trench to evade it; we seemed to be caught in slow motion. We couldn't move fast enough to...there was a colossal thud. The ground shook; snow sprayed up twenty feet. Everything disappeared. I couldn't breathe. I was flying through the air. I hit, and it didn't hurt at all, but I couldn't hear. The sound of the 'Mech falling played itself over and over in my eardrums. I looked for the squad. All I saw was snow. Snow, and a broken Ostscout. As I waded toward it through the snow, I saw a wisp of steam rising. Perhaps someone was alive! Then, seeping upward through the snow, came red, the red of bright arterial blood. Scooping through the slush I found an arm, a yellow mitten, more blood, already turning cold. It puddled, a freezing pool of red, a quiet testimony to violent death beneath. I found myself running through the snow with a rock in my hand, lamenting my vanished rifle as I sought a way to do violence to the 'Mech.

Down the road, a barrage of long range missiles jolted into the Hatchetman, while autocannon rounds whanged and flashed around the Stinger. That Stinger pilot was good! He was airborne almost before he was hit, jumping clear over the hummock to land behind the attacking Patton. The Hatchetman's autocannon flared to life.

I was almost to the Ostscout now. The 'Mech's fall had started a snowslide. The dirty snow slipped and crumbled under my feet. A body fell, not fifty meters from me, landed with a dreadful limpness. Jessop. I tracked through red freezing crystals, trying not to think what might be below.

A flare! The Patton's crew flamed the jumping Stinger. A roaring as the Patton and the Hatchetman exchanged missiles and autocannon fire. The Stinger was airborne again, firing all weapons at the tank as it leapt to the apparent safety of the second hummock. The first Pack Rat, the one near the Patton, opened fire on the Hatchetman.

He returned with his medium lasers, spraying the scoutcar's armor.

I scrambled along the fallen 'Mech, scraping snow away from the cockpit, intent on the pilot's life.

The Stinger pilot must have forgotten the second Pack Rat. His attention was focused on moving and firing, keeping in motion, keeping his barrage on the Patton. It was an expensive mistake. The Pack Rat got him at short range with the entire six-rack of missiles. He went down on one knee.

The Hatchetman must have won medals in gunnery. He raised his autocannon deliberately and scored on the Patton again. He was closing in on the tank now, letting his medium lasers rake the first Pack Rat again.

The Ostscout's canopy was icing over. I found a release lever and pulled it across. Now I'd have a chance at him!

A lucky hit on the immobile Stinger! The ammo in his center torso blew. One burst, then another, larger explosion. The flame of the explosion welled out and out, until the cloud of fire enveloped the attacking Pack Rat in its awful glow.

The Hatchetman and the Patton traded laser bursts, following with autocannon fire. The Patton wasn't hitting with its autocannon; I wondered if the tracking mechanism had been hit. The 'Mech was almost on top of the Patton now, starting to raise that huge hatchet. The tank scored this time; I could see large chunks of armor falling off the torso. But he'd been firing his autocannon steadily as he advanced, the crump of each shot followed by the thud of a hit. The Patton was coming apart.

I turned to the opening canopy. The pilot lay half off his couch, neurohelmet still in place. The neck was turned at an unnatural angle. There was a picture stuck to the control panel, some blond woman. The pilot sprawled like a ragdoll. Whatever I'd meant to say to him or do to him; he had an unanswerable response. No way to even the score here for Chang or Hogan or little Frances.

My leg had begun to hurt badly. I looked down. There was a big chunk of shrapnel embedded in my thigh. Blood was running down my leg. I was leaving red tracks wherever I went.

The Hatchetman brought its weapon down hard on the first Pack Rat. There was no way I could reach them; nothing to do if I could. As the hatchet descended to finish them, the Pack Rat's crew scored with their last set of missiles, three hits directly into the torso. While the Pack Rat's pieces were still flying into the air like split kindling, the Hatchetman's chest erupted. Its head seemed to explode a fraction of a second before the chest did! Now the head was moving, was coming through the air, was seeking me out on its rockets. The head leered like a giant skull, as it seared towards me, with the same dreadful slowness as the falling Ostscout. It was going to hit me n... it passed over my head! The rockets flared a second longer, then it came to rest in a snowbank ten meters away.

Nothing moved. The sounds of battle had stopped. There were no voices, no motors. My ears hummed with cold and silence.

I tried to walk toward the Hatchetman's head. Everything was so slow. My legs were heavy, heavy and sore. I tried to drag my left leg behind me. Mother, believe me, I tried as hard as I could. But I can't make it move any more. Did we really take out three of them, just militia against line-regiment 'Mechs? I can't get over there to check on him. I guess I've done all I can. I can't see him very well. It seems to be snowing again.

How odd! I'm quite warm now. Warm all through. The snow is like a thick blanket. Maybe I'll just have a nap while I wait. Nobody will mind, will they? It's so lovely to be warm.

More Than Warriors

Nature's Woe

**Autumn leaves falling,
their pale hues blanket the wounds
wrought across the land.
The children of nature mourn.**

**The tattered meadow,
trodden paths of armed advance,
beckon soothing rain.
Gentle tears from heaven fall**

— Brother Noto Shimatsu.

Brother Noto Shimatsu was instructing the young acolytes from Mt Jima Monastery in the finer principles of natural landscape gardening on the fateful autumn morning of September 23, 3028. The heavily overcast skies were soon penetrated by DropShips bearing an advance Steiner Recon unit (this unit has never been identified). Brother Shimatsu ordered a hasty return to the confines of the monastery where he alerted the Yorii Planetary Garrison based some forty kilometers away near the city of Sabu. Several minutes later, members of the 12th Sun Zhang Academy Cadre (Student Corps) met and engaged the Lyran invaders amongst the rolling hills and carefully crafted landscape at the foot of Mt Jima. By late afternoon the battle was concluded, and Steiner forces withdrew from the decimated meadows. As the enemy DropShips peeled from their landing zones, the overcast skies gave way to a soft and soothing rain, a gentle comfort to the defiled monastic gardens. It lasted for five days and five nights.

In disbelief that anyone could destroy the work of centuries in harmony with nature, Brother Shimatsu composed the poem above. For his service to the Draconis Combine in alerting the planetary garrison to the impending assault, he was awarded The Watcher of the Dragon's Eye.

Under his tutelage, acolytes from Mt Jima Monastery have laid the groundwork which will eventually return the grounds to a state of harmonious splendor. The frail Brother Shimatsu destroyed his health with this tireless labor.

On March 23, 3029, Brother Noto Shimatsu was laid to rest on a hill overlooking the majesty of the vast gardens. As the ceremony ended, nature expressed her sorrow with gentle rains — rains that again lasted for five days and five nights.

FIGHTING SPIRIT

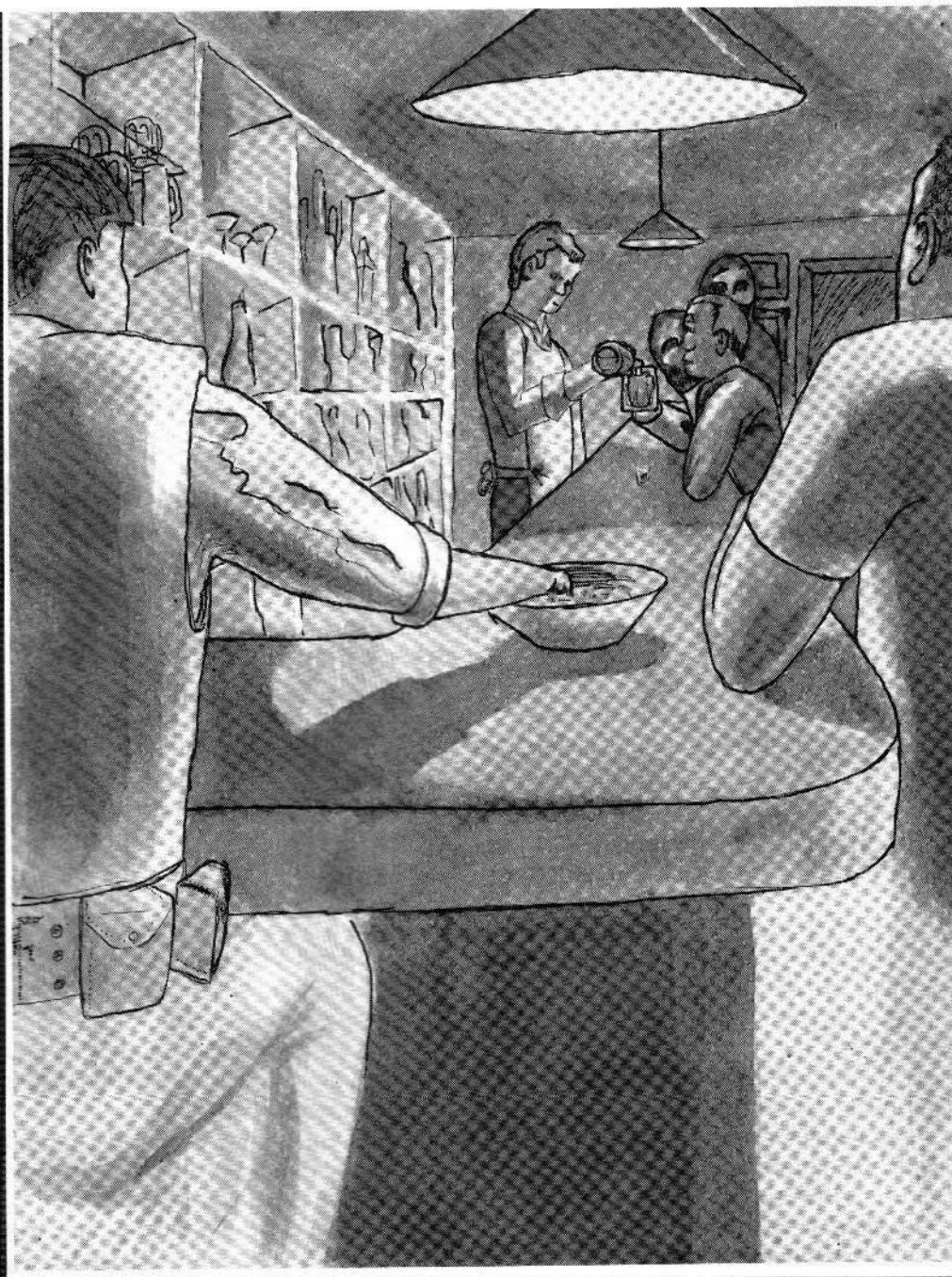

Tales of the Cobalt Coil #1

Recorded at the Cobalt Coil, Solaris (see note at end)

The Cobalt Coil isn't the hottest night spot on Solaris but then, it isn't the priciest either. We let places like Valhalla, Chez Juan, or the Gilded Flair vie for that distinction. We'll let them cater to the "in crowd". You know, Hot-shot 'Mech pilots, exiled big wig politicals, groupies, spies and that sort. We don't go for flashy decor, watered drinks, and hidden micro-electronic ears. The Coil offers a safe retreat (ie, we pay off the local gangs to keep their gripes outside), where you can park your cooling vest and side arm at the door, then down a few of your favorite drinks and enjoy a convivial atmosphere. Everyone's welcome at

the Coil, as long as they keep the peace and pay their bills.

With a name like the Cobalt Coil, you might assume that we specialize in PPCs; which we do, although there's a little concoction of mine called the Flaming Coolant that has its legion of devout followers. There are some who say you measure its potency not in proof but in horsepower. The secret of its formula is just that, a secret. It'll die with me, though its legend will linger on. Funny, after twenty-three years with the regiment along the Kurita border, old Jansfield will be remembered only for the pale green drink he invented.

Back to the PPC, a drink not for the unwary. Every second Terran Standard Friday when I come on duty, the PPCs go for half price. (Yes, the management knows, bless her flinty little heart. The number of drinks sold in a night more than make up for the reduced profit per drink. Aside from being the chief bartender, I also do the books.) This brings out two types of customers, the young hot shots, usually MechWarriors or Techs with something to prove; and the old hands, veterans of countless battles across the Inner Sphere. Come twenty hundred hours, the lightweights ("recons" we call them) are either out cold on the floor or out back punching out the mostly liquid contents of each other's much abused stomachs. Then the veterans ("assaults") get down to the true business of the night, story telling.

Yeah, the half price night is always interesting. Blake's Blood, even most of the off duty staff come in to listen. But every now and then something, well, different happens. Kind of like going out on a routine patrol and stumbling over a cache of LosTech. Last week, for example...

Someone had gotten us started on inexplicable happenings. After a few hours we'd heard some fairly good tales of ghost DropShips, haunted planets and radio messages from long lost "mech legions that warned of impending disasters. A cold, sulfur-laced wind was shipping past outside, making the vitron panes rattle like dice. It lent a perfect spooky air for ghost stories, though it kept reminding me to tell Len, the main day man, to re-caulk the windows. I was just setting down a new round of drinks as an aerospace fighter jock finished her tale. Once she'd fought five glowing spheres in the upper atmosphere of Kingwheel. They didn't show on radar, vanished when struck by missiles but were unaffected by lasers, and turned her wingman into airborne rubble. I suspected that "They" were ball lightning attracted to the ionization trails of the fighter exhaust, but far be it from me to break the mod. The bar drank a toast to her dead wingman and all the companions we'd each lost. Then it got quiet for a moment as we remembered our dead and waited for the next story. Shadak spoke up.

Shadak had been a regular since before I made planetfall. Until that night I'd have sworn he was incapable of speaking more than two dozen words in a night, including his drink orders (New Avalon ale with rye chasers). The only way we knew his name was from the ID strip on his jacket, a tattered

and much repaired Davion Home Guards regular issue. We all assumed it was issued to him; few people are fools enough to wear a Home Guard jacket they didn't earn. You could see where the officer's insignia had been removed. Shadak's face was something mothers could have used to frighten uncooperative children; it was deeply etched with a web of scars and burn pits. I'd seen wounds that made that sort of scarring once before. A man's 'Mech overheated, blowing most of the cockpit instrumentation. The force of the blast shattered the face plate of his neuro helmet, driving the fragments back into the pilot. That one died before we could pry him out of his machine. I guess Shadak was tougher.

"My last assignment as a pilot trainee took me to Svenson's Drift," he said as he set down his mug. "You haven't heard of it. It's a desolate little place out towards the Periphery in Davion Space. I had been attending the Templar Academy; it was a privately run 'Mech academy that funded and trained promising pilots from families that didn't own BattleMechs. It was kept solvent by private grants and a generous government subsidy with the understanding that Davion regiments got first crack at graduates. The academy in turn got a few salvaged 'Mechs from AFFS operations. They were not top line combat machines but they were serviceable and go lots of maintenance. I learned in them.

As part of our last year of study, all cadets got to participate in an off-planet patrol. Svenson's Drift was about eight light years from the academy right along a regular jump ship route, so it was cheap to get there and back; the Templar Academy needed cheap. There was not much on the Drift, just a few academy buildings, a "Starport" that was no more than a ferrocrete slab and two maintenance bays, and a Davion Science Foundation remote monitoring station that watched a nearby trinary star system. We used the Drift as field camp. We would run maintenance on the station, bring its collected data back with us, and spend the rest of the time on planet drill in our 'Mechs where we could not do significant damage to the locals. The Drift was about the size of Mars in the old Terran system; cold, dry, and lifeless. The atmosphere was thin, about ninety percent nitrogen with a smattering of noble gases to make up the rest.

Five of us went out for a three week 'Mech camp; four last-term cadets, Hotchkins, Sanchez, Ramcon, and myself, along with old Master Sergeant Sinclair.

Sarge was a veteran of the Davion House Guard. Just under two meters tall and almost a meter and a half across at the shoulder, he looked rather like a scaled-down shabby 'Mech. He acted the part of the tough sergeant, but it had not taken us long to tag the soft core inside. You see, Master Sergeant Sinclair really cared about his cadets. I can't remember how many times I saw him spending late hours helping one of us with a nasty engineering problem, giving personal tips on weapons targeting, or just offering a sympathetic ear to a teenage clod farmer who suddenly realized he

was light years from home. I suspect that was why he'd left the Guards; he hated to watch the bodies of people he cared about being pulled from the shattered wreckage of destroyed 'Mechs. As an instructor he could arm us for war, then send us out while telling himself we would all survive. Sinclair was at best an average MechWarrior but I do not think I've ever met a more compassionate man.

So five of us were left on Svenson's Drift for three weeks of exercises. We spent our days practicing in academy 'Mechs during simulated drills. For the cadets there were two pair of reconditioned Stingers and Locusts, while Sarge had his old battleworn Jenner. Ammo was in short supply (the almighty Cb making its power known again), so we did not do a lot of live fire drills with ballistic weapons, but in all it was a well run training system. We practiced jump maneuvers, field maintenance, organized tactics, and such. Blake's Fire, we even had an obstacle course complete with full sized computer controlled 'Mech mockups. The only real danger was that atmosphere. It was cold enough to allow us to put out 'Mechs through their paces without much heat buildup, but if your cockpit leaked you would quickly suffocate — or freeze, if decompression didn't kill you first. If you ventured outside without an environment suit, you wouldn't last a pair of minutes. It added that razor touch of danger to remind you that it was not all a game.

Things went as planned until the end of the second week. Then that damned remote station cut off without warning. Sarge decided to use this as another drill. We would head out in formation, suit up in our 'Mechs, fix the blasted data collector, and then head back. The whole exercise was to be conducted as if we were behind enemy lines in a free fire zone. Off we went.

By shortly after noon, we had covered the twenty clicks to the plateau where the station was set; an ugly red rock protuberance with flanks cut by

hundreds of wind carved canyons that from a distance looked like a giant tomb. A narrow switchback ramp had been bulldozed into the side of the plateau by the original construction crew, so in deference to the non-jump capable Locusts, we gathered at the base so we could climb together. That was a mistake.

The first warning we had that something was wrong was a slight shudder of the ground. Then Sanchez screamed "Look right!" It was a Marauder painted flat black. As it unleashed its fire on Sarge's Jenner, the flair of its energy weapons revealed an electric blue tombstone emblazoned on each arm-mounted weapon pod.

Two crimson laser beams carved armor from the Jenner's right arm and torso while autocannon rounds stitched a line across the 'Mech's head. Then a single blazing spear lanced from one PPC, cutting through the Jenner's left side in a shower of molten armor. We all watched the infra reds on our instrument panels show the Marauder spiking into the yellow zone as it stepped toward us. Sarge tottered for a moment, then toppled forwards, crashing into the rocky ground. In moments the Marauder had cooled to blue level and was less than thirty meters away. We stared down the barrels of those twin Particle Projection Cannons and lasers as a sardonic, faintly accented voice came over the com.

"I think you children had best surrender," it said, the contempt so thick it could've reflected a laser bolt; "I'll give you two minutes to abandon your 'Mechs. If you don't, I'll be happy to reduce all four of you to slag!"

You all may not remember Jared Curto, but in our day he was infamous. The third son of a minor baron from House Kurita, Jared wished to improve his prospects of inheritance. His two brothers died in an orchestrated accident. Unfortunately for Jared, his father deduced what had happened and took exception. The disinherited and outlawed Jared decided to evacuate. He

stole a 'Mech, hijacked the family Drop-Ship, and with a few loyal (or opportunistic) followers, headed into space. He became a part-time bounty hunter and full-time scavenger of the Inner Sphere. His favored tactic was to ambush smaller 'Mechs, then sell whatever survived the lopsided battle. He knew we were on the Drift, so he came in, shut down the station (probably intending to strip it later), then waited for the lambs. And here we were.

We'd just about decided that panic was the one logical alternative when we heard that mocking voice again. "I grow tired of waiting, children. Do you wish to fight?"

With that, a bolt of manmade lightning lashed from the right pod, blasting the left leg of Ramcon's Stinger into scrap. Ramcon tumbled backwards and the rest of us began to disconnect from our 'Mechs. Then another voice came over the com which froze us in place.

"Not with my cadets you don't!" it hissed through waves of static. And the Jenner clambered to its feet. Curto's Marauder turned as the Jenner's four lasers stabbed out at it. Two missed, searing holes into the red cliffs. The other two cut patches of black armor from the heavy 'Mech's right arm and center torso. And the duel began.

Actually, it was more like a lethal ballet. Curto was a damn good 'Mech pilot, no Justin Xiang, but good; even beating up weaker opponents is bound to teach you something. His Marauder was in near peak condition with massive fire power and armor advantage, compared to a Jenner. Sarge had already taken some solid hits. As I mentioned, he was not one of the great pilots of his day, even when it was still his day. Even with the advantages of speed and jump capability on the side of the Jenner, it should've been a one-sided battle. It was, but not the way you would expect.

Something seemed to inspire the Sarge, for his 'Mech moved like a thing

alive. Countless times I watched in stunned silence as it nimbly danced aside or ducked out from under a barrage of destructive energy that would've destroyed it. It kept close, under the normal range of a PPC, but too far away for the Marauder to land a crushing punch or kick. And Sarge's lasers kept licking out like a brace of knives in the hands of a vivisectionist, cutting away armor; probing for weaknesses.

He used his short range missiles sparingly, more for diversion than attack and kept hooping about with his jets. At first Curto was verbally disdainful of 'the bouncing flea', but as his Marauder began to run hot and all he could land were occasional glancing shots on the battered Jenner, he got quiet. As breaches began to open in his armor he began to curse. And still the Jenner stayed beyond his reach.

In the span of a few minutes, the awesome black monster was a flayed and lurching hulk. The Jenner was not doing much better; I do not care HOW good you are, you can't stand toe to toe with seventy-five tons of first rate BattleMech and walk away with the shine still on your armor! But...Sarge was still fighting, while Curto was screaming incoherently. Then Sarge pulled the single most elegant combat maneuver I've ever seen. He spun his machine counter-clockwise while Curto was trying to turn clockwise. The SRMs peppered the rear torso of the Marauder while all four lasers sawed into the right leg. Great curls of armor like giant springs peeled back from the assaulted limb. Suddenly the armor was gone, and the hungry read light slashed through myomer bundles and into the titanium "bone" just below the knee.

With a harsh splintering crack, the leg gave way and the Marauder, or what was left of it, settled to one knee. It looked like it was kneeling to accept some great honor. Sarge's Mech stood there for a moment, pale sunlight fracturing from his canopy in a prismatic

rainbow display. Then he turned toward us.

"Think you could lend your old Sergeant a hand?" that so-familiar voice asked.

That broke our trance. As one we all fired our weapons into the back of the stricken Marauder. I don't know whose laser or missile did the job, but by our second volley, something touched off the Marauder's unspent autocannon ammunition. That Mech came apart like a cheap toy smashed

though none of us felt we had earned it. After graduation we were all snapped up by waiting AFFS units. The Jenner was judged a complete loss so it was stripped for parts and the hulk scrapped. I've never been back to Svenson's Drift."

Shadak paused to sip from his tankard. The bar was still. We could tell Shadak had a final salvo to fire. His epilogue was yet to come.

"It was not until some week later, after all the hoopla had died out, that it hit me.

Sarge's lasers kept licking out like a brace of knives...

by a willful child. All the while there was no sound from the Sarge. Only our voices came over the com.

A few of the larger Marauder chunks pelted the Jenner. Slowly Sarge's Mech tipped over onto its right side, hitting the ground in an explosion of sand and rock chips. In an instant, we were in our environment suits and outside our Mechs, trying to get to him. We blew the emergency bolts to the cockpit and scrambled in. But we were too late. We found him in his command chair, helmet in place, with frozen blood crusting his mouth. His eyes and the inside of his crack-webbed canopy were frosted with ice crystals that painted the cockpit with tiny rainbows. The vitron of his canopy must have been damaged during the battle and given way when he fell that final time.

Sergeant Sinclair was given a commendation and a posthumous promotion, then buried with full military honors. A surprisingly large number of Davion brass attended the ceremony. We four cadets were congratulated on surviving the battle. We were allowed to split the reward money for Curto even

The only times the Jenner took head hits were from the opening autocannon salvo and, possibly, when it fell forward right after that. The head was untouched during the duel; the second fall put it down on its right side. When Sarge turned to face us that final time we saw sunlight reflecting from his cockpit. Blake's Blood, the sun was just past the zenith; it was shining near straight down. The sun was reflecting off the ice that had already formed inside the canopy. That meant the Sarge was already dead.

The way I reconstruct it, the opening barrage from the autocannon hits weakened the vitron canopy and may've knocked Sarge out. The first fall did the rest, the jar of the impact splitting open the cracks, letting in that thin, aching cold, lethal atmosphere. Sarge died while Curto was threatening us."

Shadak drained his drink, tossed a some crumpled Steiner Five-C notes on the bar and started for the door, fastening his weathered jacket as he went. He opened the door, then paused as the cold air hit him. As if addressing

the wind, he said, "You know, a 'Mech is not that different from a human body. Myomers serve as muscles, armor as skin, and miles of optic fibers and wire as nerves. Is it possible that the spirit of a man might abandon one body for another? Suppose there was some great cause, like friendship or duty driving the man into the machine? I've wondered every time I've made that miraculous jump, had my weapons lock on an instant before my opponent's did, or whenever it felt as if my 'Mech was actively helping me. I've wondered...was there some part of that dismembered Jenner patched into my machine? Or maybe a part of some other guardian angel's old BattleMech?"

With that final question, and with all the implications it raised, hanging in the air, Shadak vanished into the night. For a few moments we were all silent as we thought of the fusion of 'Mechs and men, or the friends we'd lost and the machines destroyed. Then a voice called for a Steiner PPC. I reached for the grain alcohol and the peppermint schnapps. Slowly conversation seeped back into the bar while outside, night winds tormented the window panes.

'Jansfield' may in fact be Captain Sigfred Jansfield, late of Winfield's Brigade, one of the crack units in service to the Lyran Commonwealth. Physical descriptions of the two are quite close, and their apparent ages match. As our readers will remember, Capt Jansfield took a forced retirement from Winfield's Brigade in 3017 after twenty-three years of distinguished service, after a minor House Steiner military debacle on the much-contested world of Severn. Forty-five Terran Standard years at that time, Capt Jansfield was highly decorated and well respected by his command. In the aforementioned action, the Captain was wounded. Many think that he was also made the scapegoat for the entire affair. The decision to retire the Captain was not a popular one among those that knew him. The question of how he may have found his way to a tavern on Solaris is an interesting one. If this should prove to be the same man, BattleTechnology may at last be able to shed some light on the many questions that surround the end of Capt Jansfield's distinguished career.

After 14 years the rules for the most popular science fiction miniatures have been revised

STARGUARD!

INTERSTELLAR INFANTRY - 2250AD

FOURTH EDITION



Available in an 8 1/2 by 11 format

Price \$10.00 Postpaid
(California residents please add sales tax)

Also Available for immediate shipment are
250 Multi-pose miniatures and accessories
all in the same scale

10 Human & 6 Alien Races

30 Types Of Vehicles & Heavy Weapons

6 Infantry Robot Types

(From Warbots & Death Machines)

Card Stock Landing Craft, Huge Rainai Fortress,

Stars End City Buildings

Order Today

The Quartermaster

P.O. Box 175

Burlingame, Ca. 94011-0175

Send For Free Catalog

Technical Readout

FLE-14 FLEA

Overview

The FLE-14 Flea Type Light Battle-Mech was the prototype vehicle that eventually became the FLE-15 in its final design. First produced in 2519 AD, the FLE-14 Flea was produced in a limited 5000 unit run to test its abilities. These field tests showed that as an upgrade for the replacement of the TRP-10 Trooper crowd control/scouting 'Mech, it was a poor improvement. Redesign led to the FLE-15 Flea which proved far more successful. Old Star League records show that over 20,000 of the FLE-15 'Mechs were constructed before the rise of the Successor States. The best estimates calculate that somewhere over 2000 of the FLE-15 are still in operation today, while those remaining from the FLE-14 Class number less than 200. Currently, all Flea Classes are out of production, having been superseded by newer or heavier Scout 'Mechs. The type is still a favorite of some MechWarriors, however, and no less than five popular versions can still be seen on battlefields throughout the Known Sphere.

The main mission of the FLE-14 was crowd control and fast scouting. With its nearly nonexistent armor and light weapon it must rely on its great speed and jumping ability to avoid situations in which it could be easily destroyed. The Flea is also used as an infantry buster, being able to screen heavier 'Mechs from pesky foot soldiers and their armored vehicles.

Capabilities

The FLE-14 Flea Type light Battle-Mech was extremely fast and maneu-

verable and had the largest jumping capacity then attempted by Star League designers. Its jumping ability gave it its name, although its more successful cousin the FLE-15 lost all jump capability in favor of heavier weapons and armor protection. It is ironic that the name and general design were retained in the FLE-15. At longer range the FLE-15 and its jumping cousin cannot be differentiated.

In open terrain the FLE-14 is one of the fastest 'Mechs yet created. These movement abilities help it avoid heavier 'Mechs that it could not hope to engage. Its armament is designed for medium ranges only, so care must be taken to avoid long ranged fire that could not be replied to. The Flea's main anti-Mech armament is its single Diverse Optics Type 15 Medium Laser. Although the FLE-15 and its variations carry a diversified array of smaller weapons, this did not occur on the FLE-14 (although many local commanders added twin machine guns for infantry suppression). Fleas were never designed to fight other 'Mechs. Only against infantry and their lighter armored vehicles can the Flea ever act offensively with much of a chance for success.

Battle History

During the First and Second Succession Wars, both the FLE-14 and FLE-15s were used extensively as scouts and infantry screens in almost every engagement of the conflict. Their losses were tremendous, however. In the Battle of Pohlman in 2794, fully 80% of the 300+ Fleas that were used by the forces of House Kurita and Davion were destroyed in the two month campaign. More cautious tactics have pre-

vailed in the centuries since those conflicts, and no other MechWarrior pilot has learned to be more cautious than those that operate Fleas.

More recently, during a bandit raid on the planet New Riga in 3005 AD by Hendrik III of Oberon VI, a recon lance of pirate Fleas was able to lead the defending 'Mechs away from their defense point and into an ambush. The Fleas were easily able to outdistance their lumbering opponents until Hendrik's heavy 'Mechs were able to get behind the defenders, overwhelming them.

FLE-14s very rarely saw 'Mech combat after the Second Succession War since their lives on the 'Mech Battlefield were usually measured in seconds. The added advantage of rapid jump capability never was able to outweigh the simple fact that the FLE-14 was totally outclassed. They did serve as useful crowd control vehicles, and were used extensively in rear areas protecting supply and repair bases from partisan activity.

Variants

The FLE-14 was superseded so rapidly by the FLE-15 that no official variants of the model were ever converted, unlike the FLE-15, which has at least three different versions. Unofficial variants did occur quite often through the FLE-14's lifetime. These usually included a reduction or elimination of jump capability for more armor protection and/or weapons systems. These conversions simply turned the FLE-14 into a FLE-15 most of the time.

Notable 'Mechs and MechWarriors

MechWarrior Alvira MacNeil

One of the most famous FLE-14 pilots ever to have lived, Alvira MacNeil was a scout in the service of House Davion during the Second Succession War. She was assigned to several different units, depending upon the mission those units were ordered to carry out. Alvira was a master at operations behind enemy lines who used her Flea

"Hound Doggie" to great effect in a number of operations. She invented and improved upon the "JumpGlide" effect which allowed her Flea an even greater jump range than was then thought possible. This tactic got her out of many tight spots in her numerous campaigns. A number of time "Hound Doggie" was reported to be a new type of AeroSpace Fighter by enemy intelligence sources. Her motto, "Never walk when you can glide" finally brought her to grief during a stint as instructor of Scout Tactics on New Avalon. MacNeil had made a bet that she could jump up Mount Silenas using her FLE-14. She attempted this feat with a huge crowd watching. Unfortunately, Alvira lost control of her 'Mech while trying to jump up an escarpment at the 7000 foot level and the FLE-14 tumbled down the mountainside. MechWarrior MacNeil suffered severe internal injuries and died six days after the accident.

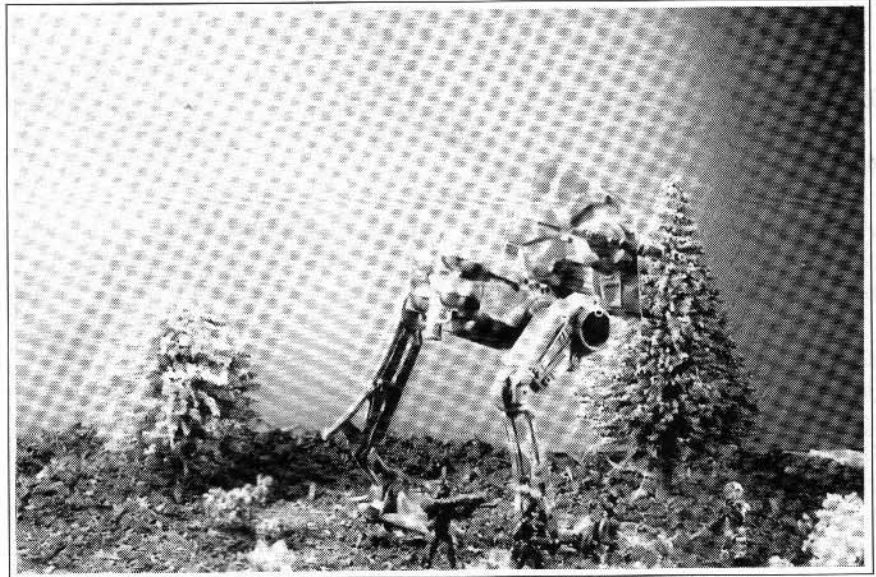

FLE-14 Flea Type Light BattleMech

Mass: 15 tons
Chassis: Earthwerk FLE
Power Plant: Magna 135
Cruising Speed: 92.3 kph
Maximum Speed: 145.9 kph
Armament: One Diverse Optics
 Type 15 Medium Laser

Main Manufacturer: Earthwerks, Inc
Communications System: Neil 4000
Targeting /Tracking System: RCA Instatrack Mark IV

Simulator Stats

Type: FLE-14 Flea		Tons
Tonnage:	15 tons	15
Internal Structure:		1.5
Engine:	Magna 135	4.5
Walking MPs:	9	
Running MPs:	14	
Jumping MPs:	8	
Heat Sinks:	10	0
Gyro:		0.2
Cockpit:		3
Armor Factor:	16	1
Head:	3	2
Center Torso:	5	3/1
Rt/Lt Torso:	4	2/1
Rt/Lt Arm:	2	1
Rt/Lt Leg:	3	3

Weapons and Ammo:

Type	Location	Critical	Tons
Medium Laser	RT	1	1
Jump Jets	LL	2	2
Jump Jets	RL	2	2

Jump System Internal Arrangement

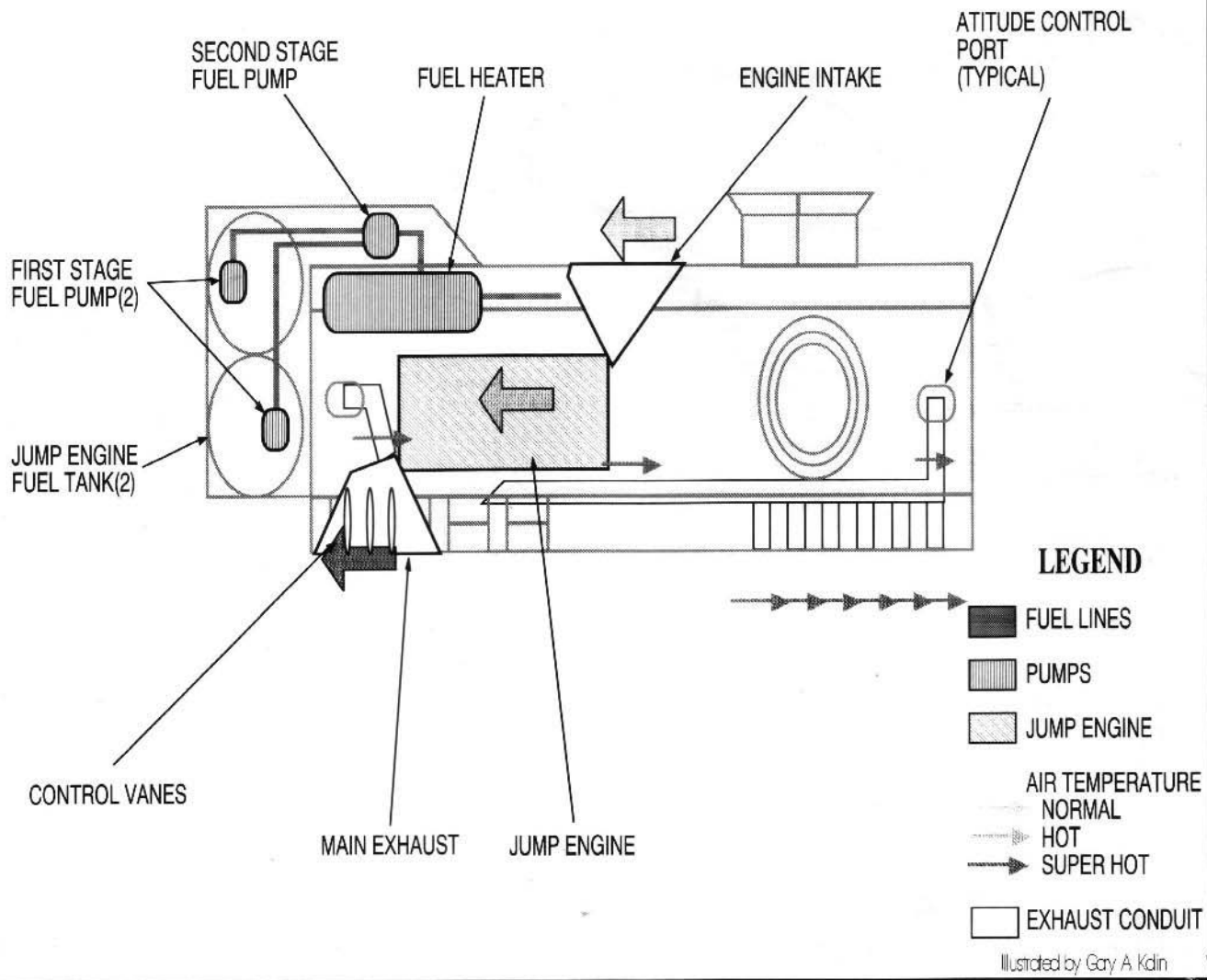

Blueprint detail showing the jump jets of the FLE-14 Jumping Flea

FLE-14 TYPE LIGHT BATTLEMECH

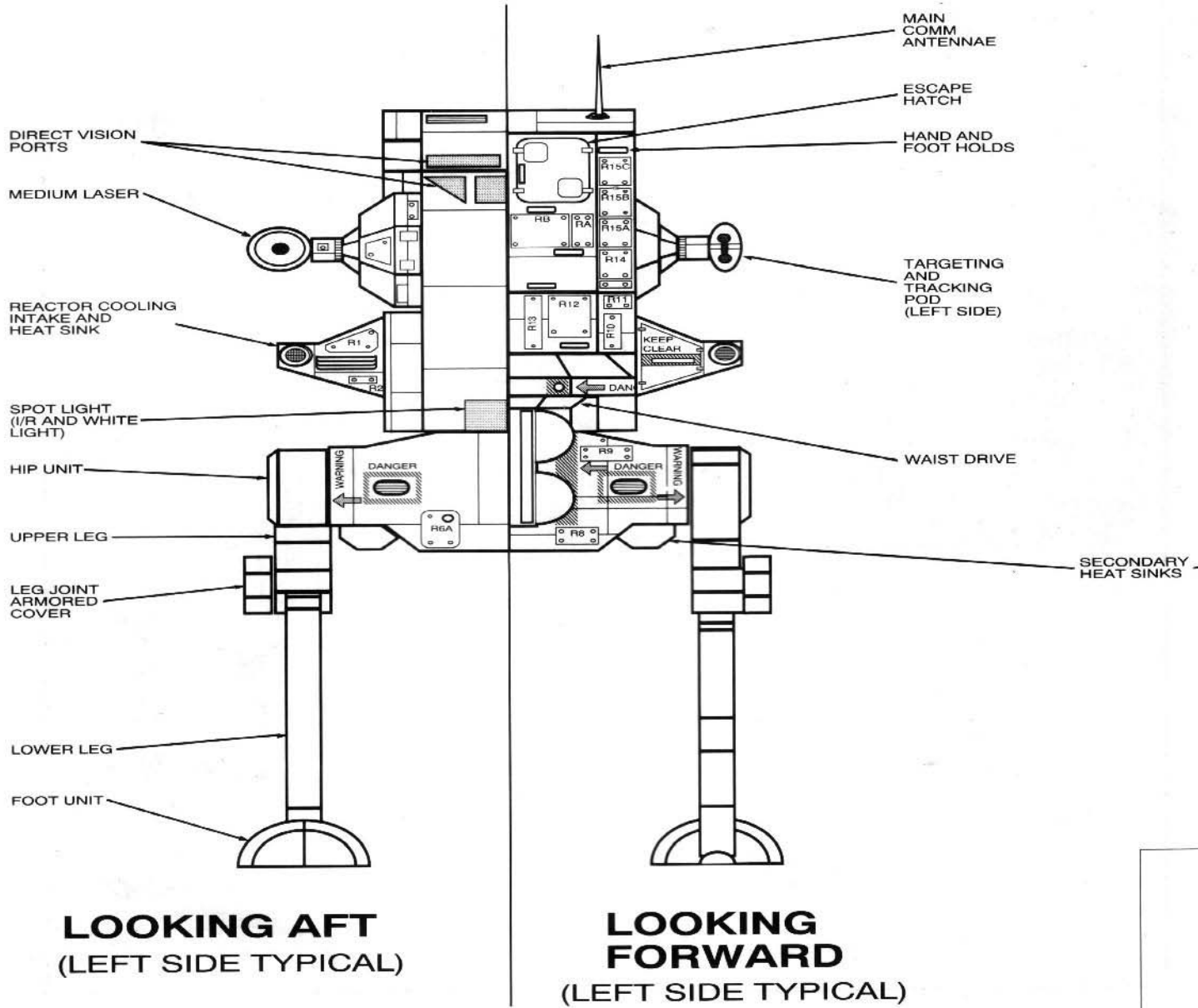

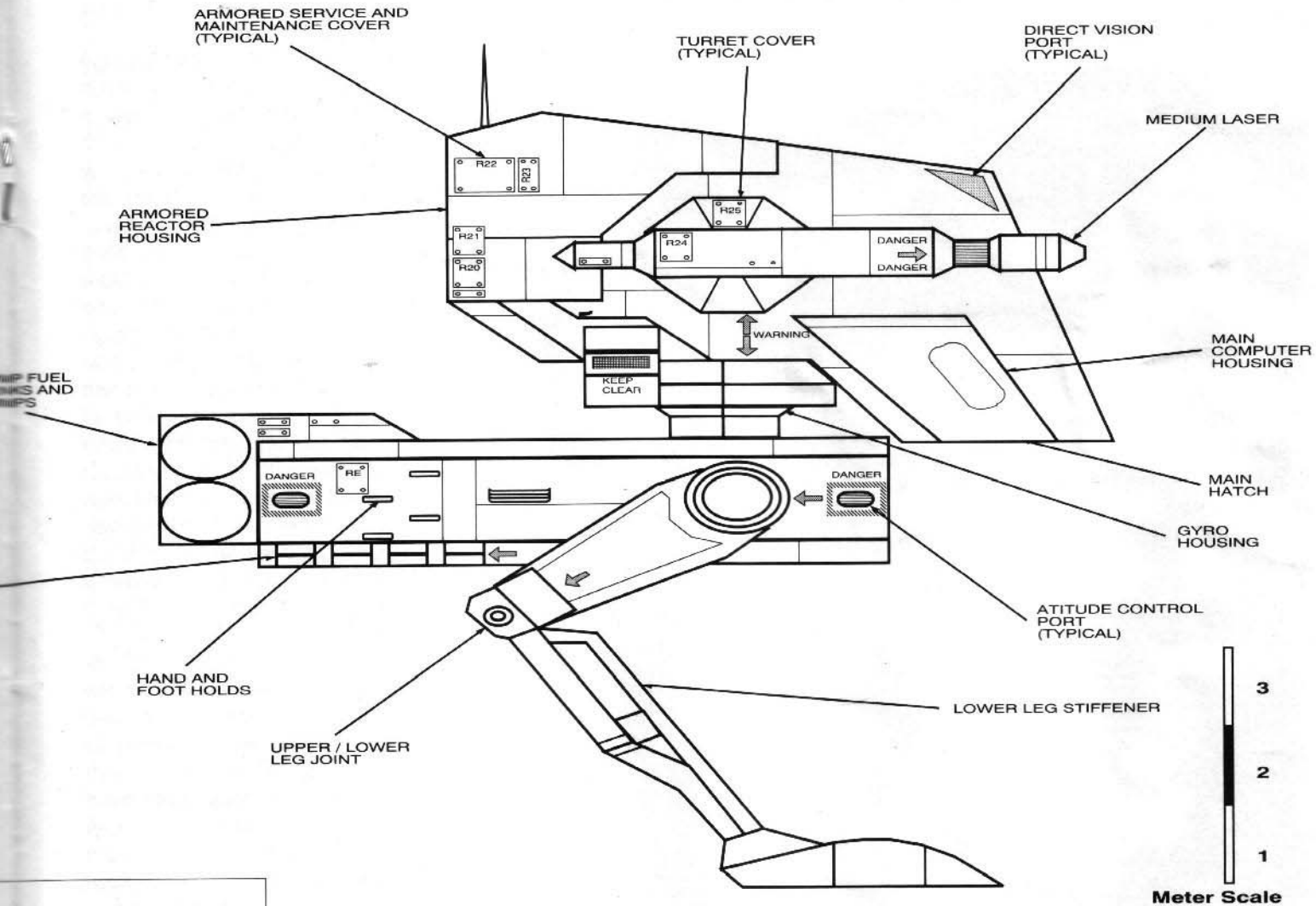

RIGHT SIDE
(LEFT SIDE TYPICAL)

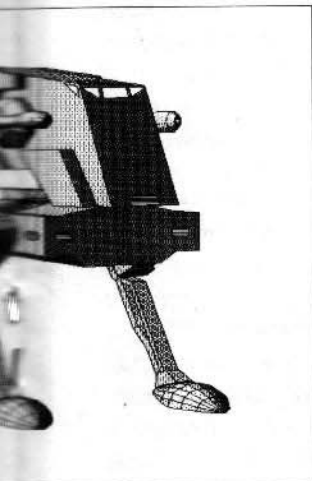

BattleTechnology
The Magazine of Combat in the 31st Century
Illustrated by Gary A. Kadin

Mc Klostey's Valley

Lt Darryl James

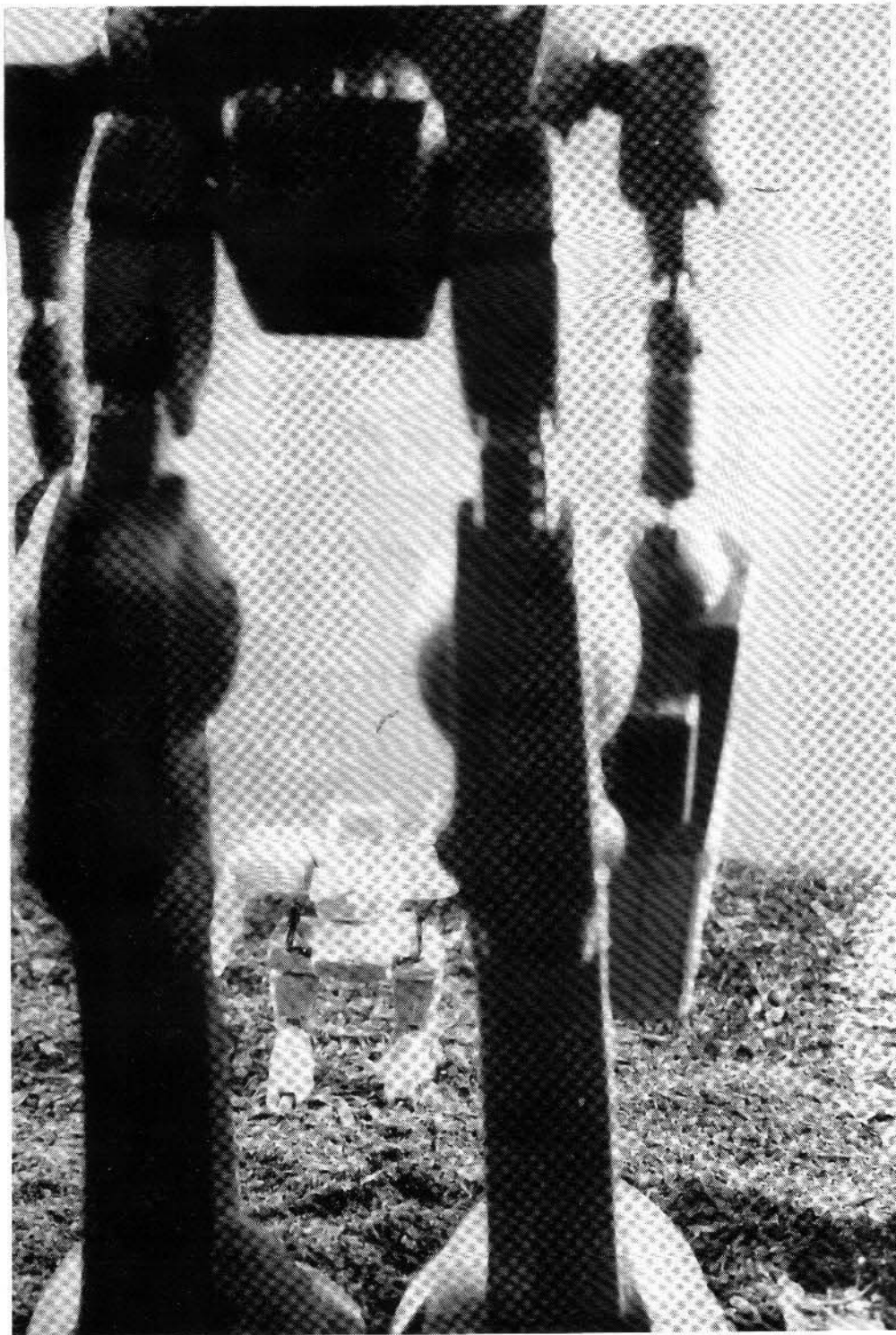

Col Andrews' office quieted as the briefing and strategy session began. The colonel introduced a man named McKlostey, who was to give us the background.

"Up until six months ago our valley was the best place in the world to live and raise a family. Quiet, peaceful, with ground so fertile you kin grow just about anything. Then them hoodlums with their infernal machines showed up. Said they came to liberate us from our oppressors. Wanted money, support for the movement. We were ta donate 100 C-bills to the cause. I told 'em we didn't have that kind of money. They said if we didn't come up with the money they'd take a dim view of it. Might even think we were with the oppressors. Said we better come up with the cash if we knowed what was good for us. They'd be back.

After they left my son Zack and my son-in-law Ed though we should fight 'em. We moved the women and valuables to Rawlins, to be safe with friends. The boys 'n me went back. Zack got some of them missile launchen' tubes and a couple machine guns from some people he knowed and we mounted them on our old Agricultural 'Mech. We made up some charges like we used to clear the stumps outa the new fields, only bigger, and buried them along the road. Figured we'd give 'em a taste and hold out long enough fer help to get there. Well things settled back down to normal, and we went on about our business. 'Bout a month passed 'n I was beginen ta think those boys forgot 'bout us or they got themselves shot up some

Situation: Gacrux

Eighteen months ago, orders from the hierarchy of House Marik came down through channels to their field agents that Gacrux, a predominantly agricultural planet, was to be targeted for a war of liberation. They laid their plans and marshalled their forces.

Phase One: destabilization and terrorism! Over the next ten months caches of supplies and well-concealed bases were constructed in the rugged southern wastes. A division of foot soldiers and propaganda experts, backed by two battalions of BattleMechs, was smuggled in to form the core of the liberation movement and direct its progress.

Phase 2: selection of puppet politicians. They would run on a "restoration of law and order" platform, with a future understanding of very generous treaties of trade and mutual defense — with House Marik, of course. Due to cultural differences and lack of understanding of the nature of the people; due to heavy handed tactics and even to demands of tribute, the people who were intended to support the Marik forces in their efforts viewed the "liberators" as bandits.

The war up until now had been a classic guerilla operation: make the government appear ineffective and powerless; attack them where they're weak; and avoid any actions with equal or superior forces. The insurgents made widely scattered attacks to conceal the location of their main base of operations. Thanks to persistent efforts of local intelligence agents, and the overconfidence of the guerrillas, the government forces were closing in on the locations of the camps. A plan had been uncovered to mount a major raid on Rawlins, the planet's main industrial complex, (125 km southwest of the world capitol, Morgan Junction). The government forces were hoping to draw the guerrillas into an open confrontation.

House Steiner's promised aid had finally started to arrive: two battalions of the Arcturan Guard and three mercenary companies were on the world now. Another battalion of the Guard and five more mercenary companies were to arrive over the next two months. The ground forces were to come from local militia units supported by two lances of the planetary defense forces. Air support would be three BL 17 Shilone fighters on loan from the customs service, backed by four squadrons of atmospheric air craft. At first glance it seems a formidable array, but with an entire planet to cover it was spread rather thin.

200 km due south of Morgan Junction is the plantation of Paul W. McKlostey, a fourth generation independent determined to make a go of it. Since the time of his great grandfather the area under cultivation has expanded to slightly over 6000 acres. Unfortunately, the 10 km wide 20 km long valley is the only pass in many hours' travel through high mountains that separate the southern wastes from the rich heartland of the continent. McKlostey saw the land as a hope for future growth, for a good life for him and his family. The insurgents viewed the quiet valley as the most direct route to Rawlins. As the pressure of opposing forces mounted, one or both views of the valley would have to change, possibly forever.

place and we didn't hear 'bout it yet. The mountains block com signals from outside.

Then one morn' Ed an' me was out worked on a irrigation pump, 'bout 2 km south of the house, and Zack was across the road cultivaten the corn when we see'd 'em comin'. Well Zack dropped the cultivators and let loose with his missile rack. Ed ran fer the house to call fer help. I went fer the detonator switches. It was somethen ta see. Couple a Zack's missiles hit the little machine in front'o the pack — I think you call'em Locusts — an' staggered it. They started shoot'n at Zack but he was ducken and blazen away at 'em. He was drawn 'em in ta where we had the charges set. Well when they got ta in the middle of 'em, I hit the switches. Man! I'll tellya that was some explosion! So much dust 'n smoke in the air ya couldn't see nothen. When the smoke started to clear one of 'em was down. I think it was a Wasp. It started to get up. It wasn't hardly even hurt; it did limp some, but that was all. 'Bout all we did was make em real mad. They spread out them. Zack saw what happened and lit out fer the woods. Half of em went after him an the rest headed fer the house."

His voice started to break on him now, but he continued with his tale.

One of the big ones, I know it was a Marauder; the government men showed me some pictures of these machines so I could pick em out. Some was hard to tell from others, but this 'n I'll remember forever. This Marauder caught Zack with his PPCs. Our old 'Mech exploded in fire an' smoke, but he weren't satisfied and started blasten away with his cannon. Then he went over an' s tomped through the wreckage to make sure there wern't nothen left. My heart felt like it was gonta stop right then and there. I headed fer the woods even though I didn't feel like it. I looked toward the house ta see if I could see Ed anywhere. Bout this time Ed came outa the field below the house and made a run fer it ta get ta the transmitter we had set up there. The 'Mechs was about half a kilometer away and musta seen him too. They started launchen missiles. The first batch hit the house. The next bunch hit the generator shed. Then they started shooten up everything. Thought I seen Ed make it to the woods but I couldn't be sure.

I hada go help Ed. With Zack gone, he's all I have left. I circled round thru the woods keepen low. I found Ed in a brush pile just inside the woods. He was cut up some, but it was the run that was hardest on him. I helped him up an we made our way to the dugout. That's where my great grandpappy lived when he first come to this valley. We don't use it much now, except for a root cellar an' storage. I patched Ed up as best I could an we crawled back out ta see what was goen on. Made my heart sick just ta look at it. They'd smashed the house an other buildins flat an set'em on fire. They was out in the fields now, trampen the crops and busten everything up. Maybe they was looken fer Ed'n me. I don't know. We waited till after they was gone and it was starten to get dark before we made our way out of the valley and got picked up by a patrol on the road to Rawlins. I only been back once since then, ta bury what was left of Zack, an ta salvage what we could. We cant do nuthen till that vermin is gone, an' I want ta help you 'bout any way I can.

The room was very quiet as he sat down.

The Colonel cleared his throat. He spread out a map and said, "This valley was a lake a long time ago. That's why both ends pinch down to less than a kilometer like this. I figure we hit 'em at the north end before they get out. If we jump 'em at the south end when they come in, they just fall back and disappear in the badlands. We'll form ourselves in a U at the north end of the valley. Bravo and Charlie Lances will mix and form the legs: Recon Lance will split on either side of the road and form the base of the U. Alpha Lance, you're the plug in the bottle.

"We don't know when to expect them; it could be two days or two weeks, but it will happen sometime soon. When they do come I think we can expect them thru here shortly after dark, to avoid being spotted by our air cover, such as it is. I want everybody to stay sharp, keep your men awake and NO NOISE. During the day stay under cover and be ready to move on short notice just in case this

doesn't

go down like I figure. We'll have a ground squad set up an OP in the south pass. Lt Jordan, make sure your men understand they stay invisible and bug out at the first sign of trouble. Also — they check in every hour."

"Yes, sir"

"Right, any questions or comments?"

"How about we put some Pack Rats with LRMs mounted on them along the north end of the valley to give us some added fire power and make our forces look bigger than we are?" I asked.

"Sounds good; I'll see what I can do."

MSG Williams, our head tech, spoke up next. "The boys and I have been working on a new jamming technique. By programing the com computers in the 'Mechs to switch to different frequencies at preset times and programing the jammer to keep the channels clear at those times for short periods, we can at least pass along orders."

"Well, it sounds like it's worth a try. If we can keep it up for twenty minutes or so, maybe we can keep them from organizing a defense while we can still work our units together.

OK, anybody
e l s e ?

No?

All right, let's get out people together and move out. I want to be set up in positions for tonight."

The air transport set us down about 5 km north of the valley so we could move in without being observed. We hoped. We formed up with the Recon Lance on the point, the Medium Lance split out on both sides as flankers, the heavies in the middle, and the infantry and support troops bringing up the rear. The mountains in front of us looked like a tall rugged wall with no break showing. As we got closer a crack seemed to open in front of us. The road we were following ran along the left side of the opening into the valley along the base of a sheer cliff. To the right a small stream and a wooded slope rose to the wall of mountains on the other side.

The Colonel's voice came over the com. "OK, people, stay sharp. This looks like a good place for an ambush."

We'd traveled about 500 meters to where the road made a sharp left around an outcrop of rock and got our first look at the valley. A cultivated strip about 2 km wide ran down the level floor of the valley with heavy wooded slopes on either side. At the left, against the woods, the ruins of farm building and machine shops were located. The wreckage of farm equipment lay scattered all about. At one time this was probably a good place to live. If you liked that kind of life.

"Recon Lance, split up and check the woods. Charlie Lance, spread out and sweep the



fields. Alpha Lance, go with them in case they need support. The rest of you form around me. Sgt Chapman, bring Mr McKlostey up here. OK people, let's move it; we have a lot to do."

It was a quiet but nerve racking trip thru the valley. The ruined crops, the broken and rusting pipes and silt-filled ditches of the irrigation system really made a desperate looking picture. As we passed the burned out hulk of an Agri Mech, I couldn't help thinking that McKlostey had guts. Thinking about what was to come and walking thru the too-quiet valley waiting for something to happen was giving me a real case of pre battle nerves. It was going to be one of those afternoons that took all day to get through. I kept the Colonel posted on our progress as we moved to the south end of the valley. All stayed quiet and as we reached the pass to the bad lands we had the place to ourselves. I called the Colonel on the command channel and told him so.

"All right, wait until the OP team gets there, then head on back and we'll get you set up in your positions. I've got the infantry digging in the LRM positions as best they can before dark. If they don't come tonight, we'll be in good shape for tomorrow night. Wish we had just a little more time."

"Ain't it always like that? Here come the ground pounders, so we're starting back," I said.

"Rodger. Charlie Lance can drop off on the way back."

The trip back was a lot quicker than the one out. I led Alpha Lance into the pass.

"Dave, take Hollinger and Fox and find a spot just inside the tree line so you can cover here, where the road turns and back into the valley," I said.

"OK, I make that about a 300 m run to get back?"

"Yo, sounds about right."

While they made their way to the woods, Pappy and I went around the outcrop. "I guess I can work Max in at the base of the cliff here. Can you get your Thunderbolt in behind that pile of

rocks?"

"Think so. We don't need much cover anyway."

"No, but I'd like at least to take out their point before they know what's up."

We had just enough time to stretch our legs and get a bite to eat before sundown. I put Tac 1 on low power tight beam. "Listen up, guys, it's been a long day. We'll rotate watches on a two hour schedule. When you sleep, be sure your controls are locked. I don't want anybody rolling over and shooting themselves in the foot. When you're on watch, stay AWAKE. Keep your com on low power and tight beam, and keep whoever's on watch with you AWAKE too. I'll take the first watch with Dave. Jim, I'll wake you in one hour, then Pappy, then Pat."

"Rodger," chorused over the com.

By the time Dave's watch was over, it was full dark. The sky was overcast, and being out in the country without city lights around makes for a dark night. I told Dave to turn in and woke Jim. Jim and I make small talk to keep awake. It's funny, you can stay awake all night to party, but go on watch and you can't hardly keep your eyes open. My watch ended and I woke Pappy, locked my controls, and turned in.

Dave woke me for my mid watch and told me all was quiet. I had my night scanner on and kept looking around even though there was nothing to see. Staying awake was the hardest part. When Jim's watch ended I woke Pappy and so it went. My watch was over, but now I was wide awake wondering if the guys on watch were going to go to sleep. A 'Mech couch isn't the most comfortable place I can think of to spend the night.

When I woke up it was morning. I ached all over. The Colonel's voice came over the Command Channel telling us to stand down. I put Max on stand-by and dismounted. They finished digging in the Pack Rats. In the afternoon the Techs topped off the fuel in the 'Mechs and made last service checks. I'd just get all settled back

down and here came a militia company clanking through in their APC's to add support to our infantry. Then Sam came around to make some changes in the computer's jamming program. The Colonel sent Lundgren out to map the valley in his Ostscout and feed the new data into our battle maps. Night operations really mess up your schedule. All you seem to get are cat naps, and you're always tired. I hoped they'd come soon just so we could get this over with.

So the day passed. The sun went down and we got ready to spend another bad night. It was just after dark when the Colonel's voice came over the com. "Everybody UP!! We got company coming. They'll be here in about half an hour. Stay quiet and don't move around. Fire one or two salvos of the appropriate weapons for the range on Lt James' command. When you hear the jamming start, move out. We hope to keep the Command Channel open, so no unnecessary chatter. Remember we have people counting on us. We have to stop these guys here and now. Good luck and good hunting."

We were ready for them, had been for weeks, it seemed like, but as the battle approached a list of things I should have checked and things I should have done ran through my mind. Pre battle nerves, I guess. No matter how many times I go through this I think I'll have them. When I don't get a case, I'll know it's time to quit. A single short tone chimed soft over the com. The enemy units had just passed the Colonel's position. I checked my outside audio pickup to make sure it was on and the volume was all the way up. A Thousand and One. Where did the time go?

I thought my ears might be playing tricks on me as I first heard the sound of metal feet moving north along the road. The sounds of the night I'd been listening to and not noticed before suddenly stopped. Now all that was out there was the sound of armored feet tramping along the road and getting steadily

louder. I cut the gain on the pickup back. I felt the vibrations from the 'Mechs. As they came closer the mechanical sounds and vibrations increased. Calm swept through my body like a winter wind. Now I was ready for whatever came. I knew by some sense I couldn't explain that something was on the other side of the outcrop of stone.

A Phoenix Hawk rounded the turn. *Just a couple more steps*, I thought to myself as I cut the audio pickup. He looked straight at me and I braced myself for attack. then it kept moving north along the road. *How could he not see me? Twelve meters tall, weighing in at one hundred tons?* As he moved on past my position I stepped out behind him and brought Max's massive right fist down on top of the cockpit with all the force I could. Max was still kind of new to me and I didn't realize the power he could generate. There was a tremendous crash. I could feel the shock of the blow with my entire body. The cockpit crumpled into the torso like a nail seated in a board with a hammer. The knee joints bowed out in a shower of Mehdrek before collapsing. As I turned to the next 'Mech coming around the bend, I saw Pappy moving out of his cover and to my right.

I stepped to the bend and started to make the turn — and came face to face with a Locust. I blocked the arm he was trying to fire on me with and my momentum carried us both around the turn. I punched him just below the cockpit, and the 'Mech sheared cleanly in half! A Marauder followed close behind. There I was tangled in a Locust with a Marauder coming at me! In desperation I took another step to build momentum, picked up the nearest half-Locust and threw it at the Marauder in a two-handed throw. Imagine my surprise when it hit! Max's power was unbelievable. "FIRE! FIRE!" I screamed over the com as the Locust hit the Marauder's left PPC, forcing it back into the torso. There was a blinding flash and my filter cut in. The Marauder listed heavily to the right. With a loud shriek of shearing metal the right leg bent backwards and it fell over on its side, spewing smoke and electrical sparks. The pilot punched out as it hit the ground.

Pappy's thunderbolt opened fire on a Rifleman about 75 meters away with lasers and his SRM 2. His laser fire racked the Rifleman's chest, tearing off chunks of armor, and one of the SRM's hit him in the left shoulder, scrubbing off more armor. As the Rifleman raised his arms to open return fire, I opened fire on him with my lasers and SRM 6. My lasers tore more armor off the chest and two of my SRMS impacted the chest, exposing internal structure. Another hit the right arm, and one hit the cockpit. My fire distracted his aim and his right arm's laser and AC / 5 ripped the space between us. His left laser just missed Pappy's left arm but his autocannon hit, splashing bits of armor into the night. While I waited for my weapons to recycle I fired my AC / 20. More armor was blown away and the hole in his chest was enlarged. Pappy fired his lasers and SRM 2 again. Lasers and both SRM's hit the hole. With a bright flash, and the roar of exploding autocannon

ammunition, the top half of the 'Mech just disintegrated.

The night sky was alive with trails of fire from the incoming missiles. They began exploding in the enemy formation, outlining it with flashes of fire as far as I could see.

I called the Colonel to get his estimate of the size of the force we were facing. The pop and snap of static was all I could hear. "Pappy, can you read me?"

"Yo, but there's a lot of static and you aren't coming through real good."

"I see what you mean." I looked at my rear scanners to see where the rest of my lance was. They were about 150 meters back and closing. "Dave, can you hear me?"

"Yes, but not too clear."

"OK, guys, form a line with me in the center. Dave, you and Hollinger on my left. Fox, you fall in with Pappy on my right. We'll advance in a line. Keep 50 meters between us. Don't bunch up. I want lance fire on all targets until further notice. If anyone sees something I missed, call out. If we have problems with communications, I'll give the dispersal signal with my arms to release you to find your own targets."

I moved Max out at a walk, which was a slow pace for the others. He's powerful, not fast. It would give Pappy's Thunderbolt a chance to cool more. Those Thunderbolts don't dissipate their heat well. We hadn't gone very far when I picked up a group dead ahead. I also noticed Recon Lance moving in across the fields. I locked in with the lead 'Mech. He was a Marauder. I opened fire with my LRM 20 and AC / 20. The rest of the lance followed my lead and five lines of fire converged, meeting at the Marauder. The missiles impacted on him and the surrounding terrain. I tracked my sights across to a Dragon as the weapons reloaded and fired again. The scene repeated. . By this time, Recon Lance was in range and they began making their high speed attack runs, moving out before weapons could be brought to bear on them. This was all too much for the remaining attackers; they turned and went back in the direction they'd come from. Recon kept dogging them to discourage them from standing to fight.

As we moved to join the battle, I was fascinated by the pyrotechnic display of the night action. The blue-white lines drawn by the PPC, weaving with the brilliant red lines of lasers and reddish-orange of missiles. The glowing dots of tracers from the machine guns moving through were like swarms of deadly fireflies. Exploding inferno rounds created a brilliant orange ocean wave crashing on a beach. All combined to make a deadly but strangely beautiful scene, and I was rushing to join it. Flares started to pop high in the sky; night was turned to day.

The strange spell I was under broke when I saw for the first time what we were up against. This was no hit and run raid. There were at least two 'Mech companies involved, with a resupply column and support troops. It must be an all-out attack to take the city complex. The city could hold out against anything but an all-out assault like this. If the attack suc-

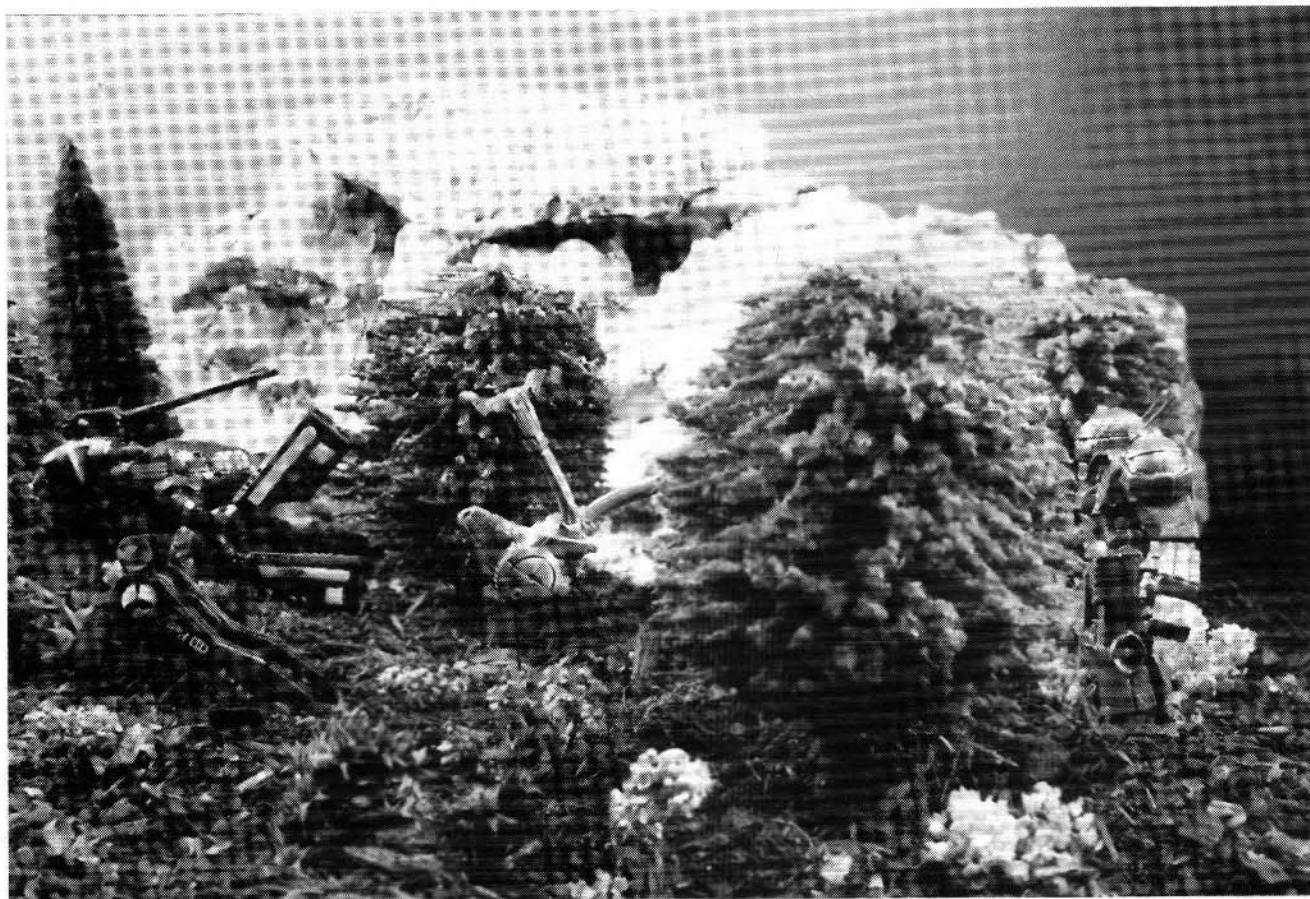

ceeded, it would destroy 75 % of the industrial capacity of an entire continent. A lot was riding on us, and I hoped we were up to the task.

As we came into range of the battle, it was a scene of mass confusion. Our company was trying to form a defensive perimeter without much success. I had forgotten the jamming until the squealing started in my head set.

I noticed the enemy 'Mechs grouping to close in their line off to my right. I moved towards them. A Shadow Hawk was standing about 25 meters to the right of an Archer, with a Griffin about the same distance to the left. I opened fire with my autocannon and LRMs. The lance was still with me and follow-

ing orders they opened fire also. He must have been in the process of firing because the armored cover of his right LRM 20 was open as our barrage hit. The force of the exploding LRMs slammed the Shadow Hawk to the ground as if hit by a giant fist. The cockpit was turned into a cloud of shrapnel, some of which smashed into the left LRM 20, but it didn't explode. Maybe it was empty. Most of the shrapnel smacked into the right side of the Griffin, staggering him.

I gave our dispersal signal and moving toward the gap opened in the line, I opened fire on an Assassin to the right of the downed Shadow Hawk with lasers and SRMs. The lasers hit in the

center of the chest; two SRMs hit in the right shoulder. There followed a shower of sparks and Mehdrek and his LRMs swung down to hang at his side. He fired his SRMs and laser at me and jumped out on his jets heading for the center of the formation. I didn't notice if he hit or not because off to my left I saw Ken Fleming coming over the line in his Grasshopper. No matter how many times I see it, I'm still impressed with the sight of a 70-ton 'Mech flying through the air on its jump jets. He landed and proceeded to raise hell in the center of the formation and on the back side of the perimeter.

I saw an Orion swing its torso to bring its weapons to firing position for a shot at him. I opened up with my lasers and SRMs on the Orion. The lasers hit on the left shoulder and head. Three SRMs hit the chest and three hit the belt line. I hammered the head and shoulders with my AC / 20. His shot went wide of Fleming and added to the destruction and confusion in the center.

I checked my scanners. Off to my right Pappy in his Thunderbolt was engaged with an Ostroc and holding his own. Fox in his Centurion was trying to finish off a badly mauled Enforcer. He was concentrating fire into it from his AC / 10 and laser. He didn't see the Shadow Hawk land behind him. I shouted a warning but the jamming prevented him from hearing me. As I brought my weapons to bear, the Shadow Hawk fired his SRMs, laser, and AC / 5 into the back of the Centurion. There was a tremendous explosion as both the Enforcer and the Centurion disintegrated in a blinding flash. I fired everything but my LRMs at him — he was too close for that — and ran at him as fast as I could make Max go. My rage made the time it took to cover the distance seem longer than it was. All I wanted to do was to get my hands on him. I don't know if he was stunned, or if the 'Mech was damaged. I didn't care. I grabbed his shoulder and wrenched the cockpit off with my right. I tried to dig the pilot out of the cockpit like a nut out of its shell, but Max's hands weren't built for that kind of work. I frustration I stomped it into the ground until nothing was left. A blow from Max's massive left hand sent the headless 'Mech sprawling.

I looked for more targets, but Alpha Lance and Recon Lance had rolled up the perimeter and there was nothing between us and the center. I looked around and saw that the rest of my lance were still up, but Hollinger wasn't moving too well. His left leg was severely damaged and this caused him to move very slowly. I couldn't get status reports until the jamming stopped.

I made form-up arm signals and started launching inferno rounds with my LRM 20 and SRM 6 into the center of the enemy formation. Pappy took his position on my right. Dave

and
Hollinger,

trailing
smoke

and
elec-
trical

sparks, fell in on my left and started launching too. Our fire joined the rest of the missiles raining down on them from the sky. "Mech fire cut into them from the flanks.

I only had four inferno loads for the LRM and six for the

I'm tired and I'm hungry

SRM. As my last infernos left the SRM tubes, I checked my ammo stores. I had two HE reloads left for the LRM, three HE reloads for the SRM, and two cassettes for the autocannon. The rest of the lance couldn't be in any better shape than I was, but I was determined to keep going even if all I could do was kick and scratch. We made our way through the flames. As I cleared the fire I saw that we'd done it. They were pulling back. Their rear guard was covering each other and retreating in good order. A Warhammer was giving hand signals and directing them. I locked on and fired an all-weapons salvo at him. Pappy and Dave followed my lead without being told to, and he was engulfed in a hail of fire. The Warhammer froze in position; it had to be thermal shutdown. I made the "disperse" signal and brought Max up to running speed. The Recon Lance came in on one of their attack runs with some of Charlie Lance's mediums joining in. It couldn't have been more perfect if we'd planned and practiced it. The sight of Max in full charge was just too much. The rear guard broke and ran.

I stepped over a Pack Rat that had been trampled in the confusion along with its crew. The place would be a gold mine of salvage if we could keep it. I saw our ground troops moving south along the flanks in their APCs and troop carriers. Out Pack Rats were still in the running, trying to get ahead to set up for more shooting. The infantry began to appear on the field gathering prisoners and tending the wounded.

I continued to make my way slowly south. The jamming stopped suddenly, making the 'Mech almost quiet. Gone were the clanking and rattle of the reloading mechanisms.

If you don't climb out of that thing

Just the steady powerful throb of the legs remained. I keyed the com.

"All right, we'll keep after them. Davie, if you or Pappy can't keep up, sing out so we know what happened to you. Then sit tight, our guys will be through shortly to pick you up. Let's move out."

We moved on toward the south end to the valley. When I think of the rest of that trip it all seems to run together in my mind. I remember seeing McCloskey with a rifle in hand helping an infantry squad round up prisoners. Rich Aterly's Wolverine was kneeling, its escape hatch blown. I hoped he made it all right. We got a distress call from a squad pinned down by an APC.

Pappy went to help out. Got another one from one of the Pack Rat crews. They caught a badly shot up Crusader making a break for the woods and disabled him. All he seemed to have left was the laser he was keeping them pinned down with. I took this one. As I approached I turned on

my outside speakers and told him, "I'm tired and I'm hungry and if you don't climb out of that thing right now, I'm going to pound it into scrap with you in it." He came out nice as you please and surrendered.

We caught up with the Colonel about 2 km from the south pass. His Warhammer was in bad shape. It limped very badly. The right shoulder was ripped open, trailing wires and tubes, coolant and lube dripping down the said. "Anything we can do to help?" I asked.

"No, just make sure they don't stop till they're out of this valley. I made it this far, and I intend to make it to the end."

Well, he did make it. Most of us did. I learned

I'm going to pound it to

later that we lost Jim Fox and his Centurion, George Yeager and his Firestarter, Frank Mallory and his Griffin, and Jim Potts, though we'd be able to salvage his Shadow Hawk. Casualties weren't too bad, I guess, considering what we'd faced, but you still hate to lose people you know.

We got the 'Mechs reloaded with ammo and set up our defense positions in the south pass to guard against counter-attack.

Over the next few days everyone worked at a hectic pace to service and repair the 'Mechs and salvage what we could.

RIGHT NOW

The Colonel figured that a mop up campaign was in the works for the Southern Wastes and he wanted to be ready. Most of the captured 'Mechs would take more time

to repair that we had, but if we ever got everything back on line, we'd be able to field six lances. There was some talk of forming another company, but nobody wanted to leave the Colonel; he was our luck.

A week passed and everybody was starting to get a case of nerves. Finally word came through. It wasn't what we expected. At 0800 DropShips would pick us up. We would board JumpShips for parts unknown. Any equipment we couldn't take with us was to be destroyed.

Scuttlebutt said something big was up, but nobody knew what. Rumors ran wild. Everything from a coup in House Steiner to a Fourth Succession War was considered. The Colonel said that he didn't know; the old contract was paid off, a large bonus was included, and the terms in the new contract were out of sight. Nobody knew anything yet.

I was on the last flight to leave two days later. The last couple of days were a frenzy of loading and whatnot. As the ship loaded I tuned in the rear scanner. The sun was setting

valley. It was too dark to see; the mountains surrounding it brought night to the valley earlier than to the wastes.

I knew I wouldn't be happy with McKlostey's kind of life. But my way of living? I couldn't help thinking that aside from the money, it was all for nothing.

Scrap

I thought for a long time, while the planet dropped away, and the DropShip

eased into space. When the acceleration

with you inside it!!

tion stopped I unbelted and went looking for a drink and some company. Why worry? Whatever was going to happen would happen. Thinking about it wouldn't change it.

We know now that what was awaiting Lt James was Operation Thor; students of contemporary history may be amused to know that Lt James left the planet on September 2, 3028. Andrews Avengers have gone to garrison duty on classified replacing classified. In the second wave of Götterdamerung, the Avengers took some casualties on the planet mentioned. Lt James is still healthy. So is Max.

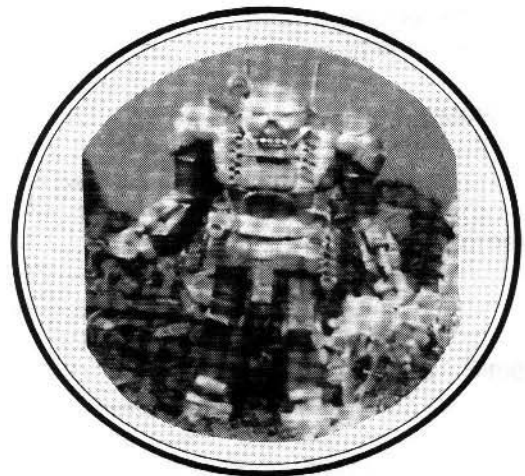

The Price of Cannon Fodder

by Jack Freeman, MechTech P.E.

TABLE #1
INFANTRY PLATOON TO-HIT PERCENTAGES
(UNMODIFIED)

	RANGE (in hexes)						
	0	1	2	3	4	5	6
Rifle	100.000	91.667	72.222	—	—	—	—
MG*	100.000	91.667	72.222	41.667	—	—	—
Flamer	97.222	91.667	72.222	—	—	—	—
Laser	100.000	91.667	72.222	41.667	—	—	—

As any experienced urban MechWarrior would testify, infantry has a useful — but decidedly secondary — role on the 31st Century battlefield. Yet the modern-day infantryman often has his best chance of surviving when surrounded by the protective structures of a city. Line-of-sight evasion and obstructing cover, two interrelated keys to longevity, give the unarmored footsoldier a slim — but nevertheless real — chance to survive multi-story BattleMechs and equally fearsome armored vehicles. This opportunity rarely exists for the lowly infantryman in open terrain.

In determining their approximate effectiveness in combat, infantry platoons armed and equipped with various weapons have different point values, measured in terms of "tonnage". (the 'INFANTRY UNITS TABLE' on pg 36 of CityTech, shows each unit's relative worth in the 'Cost/Tonnage' column.) Compared to BattleMechs, it is clear that infantry — or at least most types of infantry — or at least most types of infantry — have low values and presumably, little combat worth. To quote Col L.R. "Butch" Leeper: "In the 31st Century, life is cheap, but BattleMechs aren't."

Are all infantry units created equally, however? Are they all a poor bargain, or more to the point here, are certain types of infantry platoon more cost-effective than other types? This article examines the overall effectiveness of each type of conventional infantry platoon in terms of movement, weapon

type, damage potential, and range, and determines the best choices in terms of overall combat value per unit cost in "tonnage".

Hitting the Target

As with any other military unit or vehicle, the infantry platoon must have weapons with enough range to strike its target. The only difference is that infantry weapons in general have a far shorter range than vehicle-mounted weapons (as much a reality in the 31st Century as it was a millenium ago).

Information in the 'TO-HIT NUMBER OF INFANTRY WEAPONS' table from page 35 of CityTech, reproduced here by permission of the FASA Corporation, indirectly demonstrates the effectiveness of each platoon weapon at various ranges, unmodified by terrain or movement modifiers. By calculating the percentages at each range for each weapon, we can see more clearly just how effective the weapon is (see Table # 1). Note that flamers and SRM missiles may not always strike their targets automatically, even at point-blank range (again, no modifiers are taken into consideration)

Inflicting Damage

As we have seen, on the average a platoon will hit a target at a certain range a certain percentage of the time. That platoon, upon hitting its target, will also inflict a certain amount of damage (back to the to-hit table, under 'Maximum Damage'). For purposes of all calculations, let's assume that all

platoons are at full strength (i.e., either 21 or 28 men, depending on the type of platoon).

By multiplying the To-Hit percentages (in Table #1) by the full-strength damage potential, we can then calculate the mean (average) damage points per platoon attack. The hits and misses are averaged together mathematically, with the results appearing in Table #2. Naturally, a jump platoon armed with a particular weapon will cause less damage than a non-jump platoon with the same weaponry because the jump unit possesses fewer men.

Damage Per 'Ton'

Now that we know the mean amount of damage inflicted by each platoon at each range, we can divide the damage by that platoon's original cost in 'tons'. This gives us the mean damage of each unit's relative worth.

For example, since a foot rifle platoon costs 7 points and averages 5.056 points of damage at an attack range of 60 meters (two hexes); it inflicts 0.7222 points of damage for each point of unit cost. On the other hand, when a jump rifle platoon costs 30 points and averages 4.333 damage points at the same range, it only produces 0.1444 points of damage for each point of unit cost. Based on this alone, the foot platform is *four times* more efficient than the jump platoon!

To some, this might seem like the final answer. Each platoon does so much damage per ton, so the wise infantry commander always selects foot rifles, machine guns, or lasers, and consistently gets the most for his 'money'. First, though, we have to make sure we aren't leaving anything out.

Tangibles vs. Intangibles

In combat, four battlefield-tangible characteristics make up an infantry unit's combat effectiveness: attack strength, attack range, defense strength, and movement. Morale is the result of combat losses, availability of ammunition, reductions due to attrition or lack of supply, and other less tangible factors are generally not taken into immediate consideration (and where they are deemed important, special guidelines are presented).

Let's examine each of the four combat effectiveness factors to find out which are variable and which remain more or less constant. Except for casualty loss, the unit attack strength is a relatively fixed attribute, regardless of the tactical situation, nature of attacker, composition of target, or range. In general, a 10-point hit is a 10-point hit, period. This is partly because weapons effectiveness does not vary between target types.

The defense strength rating is another constant. The unit's defensive strength is exactly the same for all units of the same size; protective cover modifies each unit by the same factor. Therefore, the unit's cost factor has no relationship to the defensive prowess of the unit. However, the unit's movement and attack range are another matter.

As we have seen in Table #2, the attack range has a direct effect on potential for damage, but because the weapons have different hit probabilities at different ranges, the result is not simple multiplication. For example, a combat unit with a range of four hexes is not intrinsically twice as effective as a unit with a two-hex range; say, 50 percent more effective, perhaps.

Finally there is the factor of the unit's movement. In general, movement for infantry units had three primary effects. One, the greater the movement, the faster the unit can enter (and exit) battle. Two, the greater the movement, the better chance the unit can survive to reach protective cover (more favorable terrain or a more powerful friendly unit). Three, the greater the movement, the better chance the unit has to get in range to conduct its attack. The question remains: which one of these effects is most important? After all, in most infantry-related battles the fastest infantry unit is slower than the slowest non-infantry unit (usually it will also be a much weaker combatant).

After some thought, we can ignore the first effect. the infantry platoon is probable in the area already, and it seems unlikely that the movement factor of an infantry unit marching from off-board would play a major role in any combat engagement. On the other hand, if the unit is trying to exit, there's a good chance that something big and

To-Hit Numbers of Infantry Weapons

Weapon Type	Range in Hexes						
	0	1	2	3	4	5	6
Rifle	2	4	6	-	-	-	-
MG	2	4	6	8	-	-	-
Flamer	3	4	6	-	-	-	-
Laser	2	4	6	8	-	-	-
SRM	3	4	4	6	6	8	8

This table from **CityTech** is reproduced by permission of the FASA Corporation.

nasty would demolish it before it could escape. (An analogy from ancient Terran history may be helpful: the life expectancy of a lieutenant leaving his World War I [early 20-Century European] Western Front trench and going 'over the top' was something on the order of 90 seconds — or the time now required to fire nine BattleMech salvos. I suspect few infantry platoons engaged in 'head-to-head' combat against AFV's or 'Mechs would ever last *that* long.)

The second effect goes back to the unit's defensive strength. A pile of protective rubble just within movement range of a mechanized infantry platoon may help keep the unit alive when it might have been destroyed had it been foot infantry. Chances are, however, that the unit is merely prolonging the inevitable.

This leaves the third effect: getting into range to attack. (The following description is given in terms of the CityTech

infantry combat simulator game for ease of explanation). The sequence of play in CityTech has movement taking place before combat. This means a unit that is just out of range may move into range and then attempt an attack (assuming that its target does not move back out of range during its own segment of the movement phase). In some cases, the platoon's attack range is so short that 'running assaults' may be the only viable tactic.

For example, a foot rifle platoon is provided with its choice of stationary targets at various ranges. The unit (with an attack range of two hexes) may or may not move during its movement phase. If the unit is three hexes away from the desired target, it may move its limit of one hex, making it two hexes away and *now within attack range*. Thus, targets that were three hexes away before the movement phase was completed may be attacked by a foot rifle platoon with a

TABLE #2
MEAN DAMAGE POINTS PER PLATOON ATTACK

	RANGE (in hexes)						
	0	1	2	3	4	5	6
Rifle							
Foot	7.000	6.417	5.056	—	—	—	—
Mech*	7.000	6.417	5.056	—	—	—	—
Jump	6.000	5.500	4.333	—	—	—	—
Machine Gun							
Foot	10.000	9.167	7.222	4.167	—	—	—
Mech	10.000	9.167	7.222	4.167	—	—	—
Jump	7.000	6.417	5.056	2.917	—	—	—
Flamer							
Foot	9.722	9.167	7.222	—	—	—	—
Mech	9.722	9.167	7.222	—	—	—	—
Jump	6.806	6.417	5.056	—	—	—	—
Laser							
Foot	14.000	12.833	10.111	5.833	—	—	—
Mech	14.000	12.833	10.111	5.833	—	—	—
Jump	11.000	10.083	7.944	4.583	—	—	—
SRM							
Foot	13.611	12.833	12.833	10.111	10.111	5.833	5.833
Mech	13.611	12.833	12.833	10.111	10.111	5.833	5.833
Jump	10.694	10.083	10.083	7.944	7.944	4.583	4.583

*In these tables, 'Mech' refers to 'mechanized infantry', not to BattleMechs

TABLE # 3
MEAN DAMAGE POINTS PER PLATOON 'TON'
(not adjusted for movement)

	RANGE (in hexes)						
	0	1	2	3	4	5	6
Rifle							
Foot	1.000	.9167	.7222	—	—	—	—
Mech	.3333	.3056	.2407	—	—	—	—
Jump	.2000	.1833	.1444	—	—	—	—
Machine Gun							
Foot	1.000	.9167	.7222	.4167	—	—	—
Mech	.3333	.3056	.2407	.1389	—	—	—
Jump	.2500	.2292	.1806	.1042	—	—	—
Flamer							
Foot	.9722	.9167	.7222	—	—	—	—
Mech	.3241	.3056	.2407	—	—	—	—
Jump	.2431	.2292	.1806	—	—	—	—
Laser							
Foot	1.000	.9167	.7222	.4167	—	—	—
Mech	.5000	.4583	.3611	.2083	—	—	—
Jump	.3333	.3056	.2407	.1389	—	—	—
SRM							
Foot	.9722	.9167	.9167	.7222	.7222	.4167	.4167
Mech	.4861	.4583	.4583	.3611	.3611	.2083	.2083
Jump	.3241	.3056	.3056	.2407	.2407	.1389	.1389

range of two hexes. By the same token, targets at point-blank range or one hex away (before movement) may be attacked at point-blank range (after movement).

This effect of infantry movement can significantly improve the unit's chances of making a high-percentage attack. Obviously, the greater the infantry unit's movement, the farther away the target may be and still come under fire after the infantry unit's movement is complete. Table #4, adapted from Table #2, shows the mean damage per platoon 'ton' after each unit's maximum movement is taken into consideration. For a faster long-range unit such as a jump SRM platoon (with a movement of two hexes and a range of six), targets starting as far away as eight hexes could be attacked during a single movement-combat turns, and any target within two hexes might be 'close-assaulted' at at range of zero.

A Few Good Warriors

While all the numbers are being crunched, it only makes sense to take a quick look at the damage inflicted by each *person* in the platoon. The modern Art of War places little emphasis on the individual infantry-warrior, except as a small box to be checked off as casualties mount and offensive firepower decreases. Still it seemed worthwhile to look at how well each warrior performed. The number in Table #5 are based on the total mean damage by platoon attack (Table #2) divided by the number of men in each full-complement platoon.

Some interesting conclusions can be drawn from this as well. In most — but not all — cases, individual warriors in the jump platoons outperformed their foot and mechanized counterparts. It can be presumed that these warriors are more highly trained and more expensively equipped, which *should* add to their effectiveness as it seems to here. The least effective warriors, man for man were those equipped with rifles, though they remain among the most cost-effective in terms of 'tonnage'; an interesting, but not surprising, contradiction.

This result leads to "Freeman's Favorites". The damage-to-cost ratios and rankings in Table #6 were obtained by adding up all the number on Table #4 for each type of infantry platoon, then dividing by nine (for zero through eight hexes, inclusive),

to get the overall mean based on every possible range for each unit. The units with the longest effective range adjusted for movement could attack a target eight hexes away, thus setting the standard by which all other units were compared. If the unit could not attack a target that far away, tough!

For what it's worth, my pick for the best overall infantry platoon is the foot SRM platoon, with a tie for second place between the foot laser and the foot machine gun platoons. Keep in mind, however, that just because these may be the best overall infantry units does not mean they will be available. Equipment shortages and inadequate training remain relatively common in the 31st Century, and weapon limitations should reflect this in simulation. Many times (now as in the past) the 'poor bloody infantry' has had to use second best.

There will also be tactical situations where one platoon weapon is advantageous over another, regardless of relative efficiency. If I had to start a forest fire, I wouldn't choose rifle platoons no matter how cheap or cost-efficient they were. Likewise,

TABLE #4
MEAN DAMAGE POINTS PER PLATOON 'TON'
(adjusted for movement)

	RANGE (in hexes)								
	0	1	2	3	4	5	6	7	8
Rifle									
Foot	1.000	1.000	.9167	.7222	—	—	—	—	—
Mech	.3333	.3333	.3333	.3333	.3056	.2407	—	—	—
Jump	.2000	.2000	.2000	.2000	.2000	.1833	.1444	—	—
Machine Gun									
Foot	1.000	1.000	.9167	.7222	.4167	—	—	—	—
Mech	.3333	.3333	.3333	.3333	.3056	.2407	.1389	—	—
Jump	.2500	.2500	.2500	.2500	.2292	.1806	.1042	—	—
Flamer									
Foot	.9722	.9722	.9167	.7222	—	—	—	—	—
Mech	.3241	.3241	.3241	.3241	.3056	.2407	—	—	—
Jump	.2431	.2431	.2431	.2431	.2292	.1806	—	—	—
Laser									
Foot	1.000	1.000	.9167	.7222	.4167	—	—	—	—
Mech	.5000	.5000	.5000	.4583	.3611	.2083	—	—	—
Jump	.3333	.3333	.3333	.3333	.2407	.1389	.1389	—	—
SRM									
Foot	.9722	.9722	.9167	.9167	.7222	.7222	.4167	.4167	—
Mech	.4861	.4861	.4861	.4583	.4583	.3611	.3611	.2083	.2083
Jump	.3241	.3241	.3241	.3056	.3056	.2407	.2407	.1389	.1389

TABLE #5
MEAN DAMAGE POINTS PER MAN
 (not adjusted for movement)

	RANGE (in hexes)						
	0	1	2	3	4	5	6
Rifle							
Foot	.2500	.2292	.1806	—	—	—	—
Mech	.2500	.2292	.1806	—	—	—	—
Jump	.2857	.2619	.2063	—	—	—	—
Machine Gun							
Foot	.3571	.3274	.2579	.1488	—	—	—
Mech	.3571	.3274	.2579	.1488	—	—	—
Jump	.3333	.3056	.2408	.1389	—	—	—
Flamer							
Foot	.3472	.3274	.2579	—	—	—	—
Mech	.3472	.3274	.2579	—	—	—	—
Jump	.3241	.3056	.2408	—	—	—	—
Laser							
Foot	.5000	.4583	.3611	.2083	—	—	—
Mech	.5000	.4583	.3611	.2083	—	—	—
Jump	.5238	.4801	.3783	.2182	—	—	—
SRM							
Foot	.4861	.4583	.4583	.3611	.3611	.2083	.2083
Mech	.4861	.4583	.4583	.3611	.3611	.2083	.2083
Jump	.5092	.4801	.4801	.3783	.3783	.2182	.2182

flamers aren't much use in shooting down AeroSpace Fighters. Common sense must prevail in these instances.

All in all, though, Table #6 shows that a foot SRM platform is three times as effective as a mechanized machine gun platoon, four times as effective as a jump machine gun platoon, and so on. Incidentally, now that movement has been taken into consideration, the foot rifle platoon is only 174 percent more efficient than the jump rifle platoon, not 400 percent as described earlier!

One last observation: the jump infantry platoons, as a whole, do not fare well in terms of overall combat efficiency. This is because they are quite expensive (as can clearly be seen) for the amount of damage they inflict. Insufficient information has been compiled on the role, purpose or advantages of such platoons in combat, or detailing what the individual factors are which make them cost so much. Therefore they could not receive the special treatment here which they would undoubtedly deserve if more specific details were known about them.

TABLE #6
OVERALL DAMAGE-TO-COST RATIO
(adjusted for movement)
aka FREEMAN'S FAVORITES

1.	SRM Foot Infantry Platoon	.6728
2. (tie)	Laser Foot Infantry Platoon	.4506
2. (tie)	Machine Gun Foot Infantry Platoon	.4506
4.	Rifle Foot Infantry Platoon	.4043
5.	Flamer Foot Infantry Platoon	.3981
6.	SRM Mech Infantry Platoon	.3904
7.	Laser Mech Infantry Platoon	.2809
8.	SRM Jump Infantry Platoon	.2603
9.	Machine Gun Mech Infantry Platoon	.2243
10.	Rifle Mech Infantry Platoon	.2088
11.	Flamer Mech Infantry Platoon	.2047
12.	Laser Jump Infantry Platoon	.1872
13.	MG Jump Infantry Platoon	.1682
14.	Flamer Jump Infantry Platoon	.1536
15.	Rifle Jump Infantry Platoon	.1475

Send me _____ MechWarrior Personnel Files @ \$6.95 each. Ohio residents add 5 1/2% sales tax. Please indicate the House(s) you desire by writing the number of copies of each House in the blank next to the appropriate House name.

_____ Davion _____ Kurita
 _____ Steiner _____ Liao
 _____ Marik

Name _____

Address _____

City, State, Zip _____

Mail check or money order only to:
Shield Laminating, Inc.
PO Box 18253
Columbus, Ohio 43218

BattleTech is a registered trademark of FASA Corp. and is used under exclusive license by Shield Laminating Inc.
 Copyright © 1988 FASA Corporation
 All Rights Reserved

BATTLETECH® MechWarrior Personnel File

Available for each of the five Houses!

The MechWarrior Personnel File provides you with BattleTech military data documents and serves as a storage folder for all your BattleTech papers. Each file is printed in the appropriate House colors and can be personalized by you to fit your individual background. For only \$6.95 here's what you get:

- Kill Stickers
- After-action Reports
- Mech Pilot Certificate
- Colorful Storage folder
- Officer's Commission
- Letter from your House leader
- House Recruiting Poster
- Next of kin/Insurance Form
- MechWarrior Data Sheet
- Radiation Detection Badge

Available at your local game/hobby store or by mail using the order form at left.

Mary Had A Stinger LAM

**Mary had a Stinger LAM,
Its thruster drives aglow.
She bolted through the atmosphere
To close upon her foe.**

**She loosed a laser on her prey
In challenge of a duel.
It made the Cheetah bank away.
The pilot was no fool.**

**And so the Cheetah turned about
To close upon her rear.
To try to knock her engine out.
But Mary did not fear.**

**She pulled maneuvers like a pro
To meet him eye-to-eye.
All lasers fired, a cockpit blow!
She tore him from the sky.**

— “Manic” Mary Maddigan

Mary Had A Stinger LAM is a 31st Century adaptation of a previously revised 20th Century poem of similar name. “Manic” Mary Maddigan has placed herself in the title role of this somewhat violent remake. The depiction of Mary’s piloting skills are less than accurate. With over sixty kills accredited to her record, Mary Maddigan has become an accomplished pilot at the age of twenty. “Manic” Mary is a member of Lawson’s Lucky Ladies, a mercenary ‘Mech land based on the Marik-Periphery border.

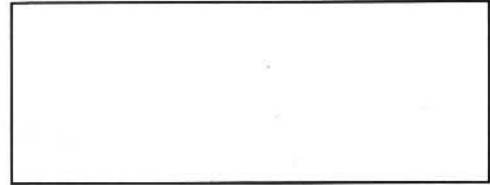

Thornhill Arms

Pages from the Spring 3029 Catalog

Viper® Semi-automatic pistol

This hand gun is chambered for 10mm magnum load rounds, well known for their reliable stopping power. Made primarily of baked composite and injection-molded ceramics, this pistol is practically indestructible from normal wear and it's corrosion resistant as well! Non-slip corrugated grips allow for easy handling in the most inclement weather. Designed for ease of maintenance, the Viper® is also very reliable and is not prone to jam. The standard magazine holds 10 rounds, but a 50 round drum clip can be purchased. Right or left handed models are available. Flat black, blued steel, or chrome.

Cost: 45 Cbs *Weight:* 0.75kgs
Extra Clips: 10-shot 1 Cb ea, 50-shot 5Cb ea

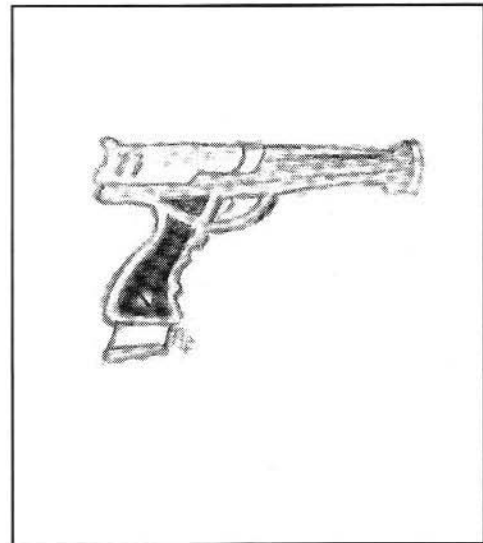

Shrike Mk I®

Another old favorite comes of age! First developed in Terra's dim past, the crossbow now enters the 31st Century with the introduction of the Thornhill Arms Shrike Mk 1®.

Made entirely of Thornhill Arms exclusive composite and baked vinyl, the Shrike Mk1® is silent, light weight, virtually unbreakable and effective. Capable of accurately delivering a quarrel at 65 meters, the Shrike Mk1® has a pull of 115 kg that is achieved with a simple move of the side-mounted cocking lever. The same motion also feeds a bolt into the firing slot from the newly developed 5-shot quarrel clip. Available in an assortment of camouflage patterns or flat black.

Cost: 25 Cbs *Weight:* 1.75 kgs *Extra 5-quarrel Clips :* 1 Cb

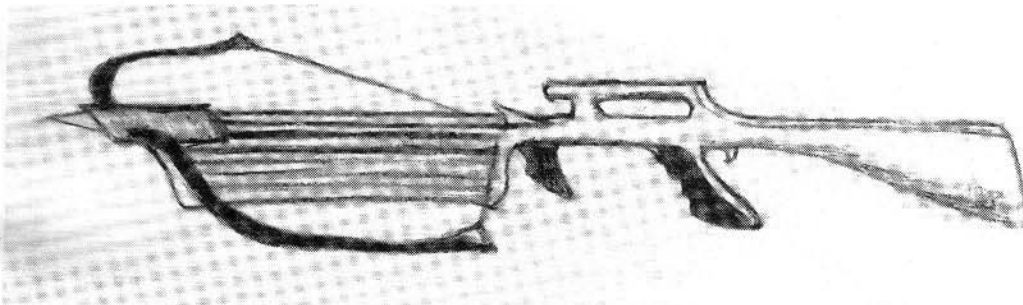

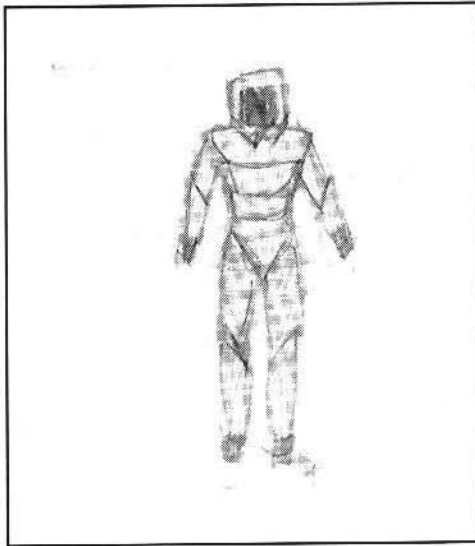

Tech Mail®

Based on the chain mail designs of the distant past, Thornhill Arms Tech Mail® has taken a good idea and made it better. Comprised of stress formed Graphite/Kevlar composite reinforced with rutile (Tungsten and silicate) micro links, Tech Mail® offers the wearer unsurpassed protection from penetration or energy attack. The quilted mylar underpadding wards off bludgeoning blows and provides for comfortable wear. Completely washable, custom fitted, available in an assortment of colors, this full-body suit covers from wrist to neck to ankles and comes with a detachable hood.

Cost: 550Cbs *Weight:* approximately 7 kg

So many people have written to us mentioning that they missed seeing the Spring Thornhill catalog that BattleTechnology has decided to reprint some of Thornhill Arms' most interesting new releases. BattleTechnology assumes no responsibility for the performance or warranted delivery of any of the items presented here. Reprinted by permission of Thornhill Arms™.

Thornhill products are available from registered Thornhill dealers all over the Known Sphere. For the name of the dealer in your area, contact the marketing department of our central facilities.

Myomer Analysis System (MAS)®

Tired of installing "new" myomer bundles only to have them snap the first time your 'Mech throws a right cross? Ever wished you could tell if a bundle had degraded just by looking at it? Well now you can! Just hook MAS® up to the terminal outputs of any bundle and switch it on. MAS® instantly begins evaluating *each individual polyacetate fiber* for signs of stress or age decay. It then prints out its analysis in less than five minutes*. The print out repeats the total structural integrity and range of motion of the entire bundle as percentages of the optimal and identifies substandard fiber sets. These can generally be removed, salvaging the rest of the bundle before complete failure destroys it! Data Ports in the MAS® unit allow for the downloading of information to any standard computer system. The Rechargeable Battery Pack provides over 8 hours of continuous operation. Repair Manual included and replacement modules available.

*Based on field tests with standard BattleMech myomer bundles of up to 6 meter lengths. Test results available upon request.

Weight: 20kgs

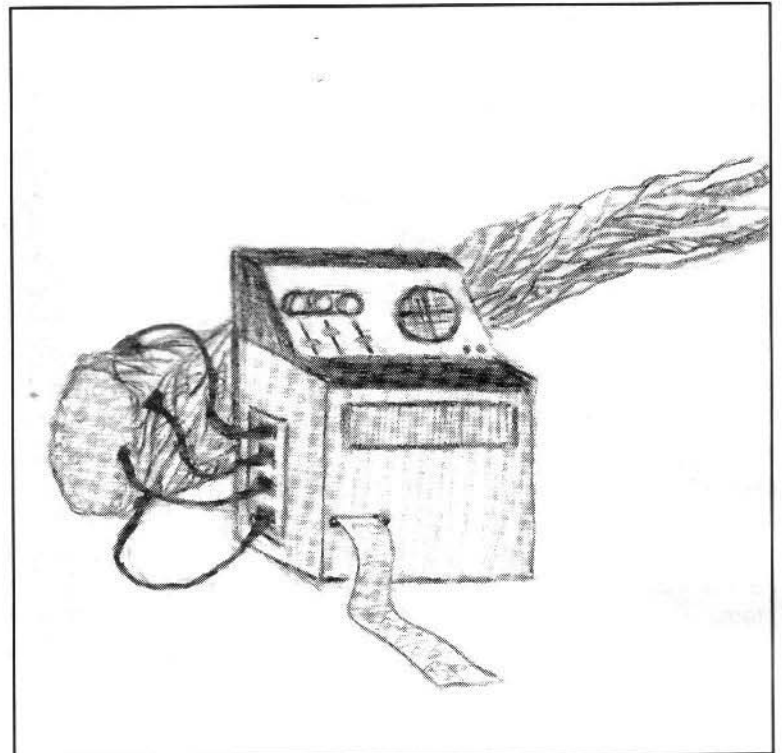

Technical Readout

Athena FDC Carrier

Overview

The *Athena* class FDC (fire direction center) carrier is an old but efficient design. First built for the Star League Regular Army in 2557, it has served on almost every battlefield in the Inner Sphere. The *Athena* forms the brain of most successful artillery units, and is considered a valuable war prize. Its continued existence is threatened, however, because of a lack of replacement parts for its powerful targeting computers.

Capabilities

The *Athena* uses a tracked chassis and ICE engine combination. This gives it excellent cross-country performance as well as mechanical reliability. Cruising and flanking speeds are well within operational requirements. The Starslab/5 armor provides protection from most counterbattery fires, while the twin SperryBrowning heavy machine guns give the *Athena* at least a minimal defense against enemy infantry.

The heart of the *Athena* is its communications and computer package. This is a three ton unit made up of a StarCom 6 long range communicator, a HawkEye 235-B targeting computer, and a SternFeur 3201 fire direction computer. The three units are linked by a Plekhanov SureLock datalink system, which ties the three elements together into an efficient whole. Depending on which computer program is loaded, this system is capable of controlling the fires of artillery units from

battery to regimental level. It also has the capability to communicate with other fire support assets, such as conventional aircraft and aerospace fighters, as well as ground combat forces. This makes the *Athena* an extremely cost-effective vehicle.

The *Athena* carries seven personnel in addition to the driver. There are two targeting technicians, two computer operators, and two radio operators. Each serves a twelve hour shift during normal twenty four hour operations. The seventh crewman is the vehicle commander, normally a senior sergeant. The interior is well-padded to enable the *Athena* to function on the move with a minimum of operator distraction.

The only weakness of the *Athena* is, ironically, its strength, the computer system. The current supply situation in the Inner Sphere makes it increasingly difficult to find repair parts, not to mention trained technical personnel. Less capable computers are used occasionally, but only as a last resort, as they seriously degrade the *Athena*'s fire-power coordination abilities.

A secondary function of the *Athena* is that of backup command post. Designers insured that the *Athena*'s systems and software were compatible with those of a Mobile Headquarters. This compatibility facilitates rapid data transfer between the two vehicles. It also allows the *Athena* to assume some of the functions of the Mobile Headquarters in the event the latter vehicle is knocked out.

Battle History

The *Athena* has seen action in every major conflict since the Unification War. Its contribution is indirect in nature but its ability to coordinate artillery and other fires has proven pivotal in many major campaigns. *Athenas* are often seen in command of self-propelled Sniper batteries in order to take advantage of each other's mobility. Some well-equipped regiments have used *Athenas* to replace wheeled command vans as backup command posts.

Variants

The most common variant involves replacing the computer package with less complex versions. Most often seen are a TacCom/5 long range communicator, a HawkEye 435 targeting computer, and a CBVM 260 fire direction computer combination. While an adequate replacement for the original equipment, this limits the *Athena* to an artillery command and control role only.

Notable Vehicles and Crews

Sergeant Roland Novak and "Battleaxe"

"Battleaxe" was the name of an *Athena* serving in the Regimental Artillery of the 15th Lyran Guards. Sergeant Novack, the vehicle's commander, named the vehicle in honor of his mother-in-law. "Battleaxe" and crew gained notoriety during the recent Second Battle of Loric when it coordinated a TOT (time on target) barrage that completely demolished a Marik Mech staging area. Twelve Marik

*Mechs were destroyed and another twenty were damaged. The Regimental Artillery received the Lyran Unit Citation of Merit for their actions.

Athena FDC Carrier

Mass: 20 tons
Chassis: CBI(SL) 20-V
Movement Type: Tracked
Power Plant: Hermes 100 ICE
Cruising Speed: 54 kph
Flank Speed: 86 kph
Armor: Starslab/5
Armament: 2 SperryBrowning Machine Guns
Manufacturer: Carlisle-Brockhurst Industries
Communication System: StarCom 6
Targeting and Tracking System: Hawkeye 235-B
Fire Direction System: SternFeuer 3201

Type: Athena FDC Carrier	Tons
Movement Type: Tracked	
Tonnage: 20 tons	20
Cruise Speed: 5	
Flank Speed: 8	

Simulator Stats

Engine:		6
Rating:	100	
Type:	ICE	
Control:		1
Lift Equipment:		0
Power Amplifier:		0
Heat Sinks:		0
Internal Structure:		2
Turret:		0.2
Passenger Compartment:		1

Armor:	72	4.5
Location	Points	
Front:	18	
Lt/Rt Side:	12/12	
Back:	10	
Turret:	20	

Weapons and Ammo:		
Type	Facing	Tons
MG	Turret	0.5
MG	Turret	0.5
Ammo (MG) 200	Turret	1
Communications and Fire Direction Equipment	Body	3

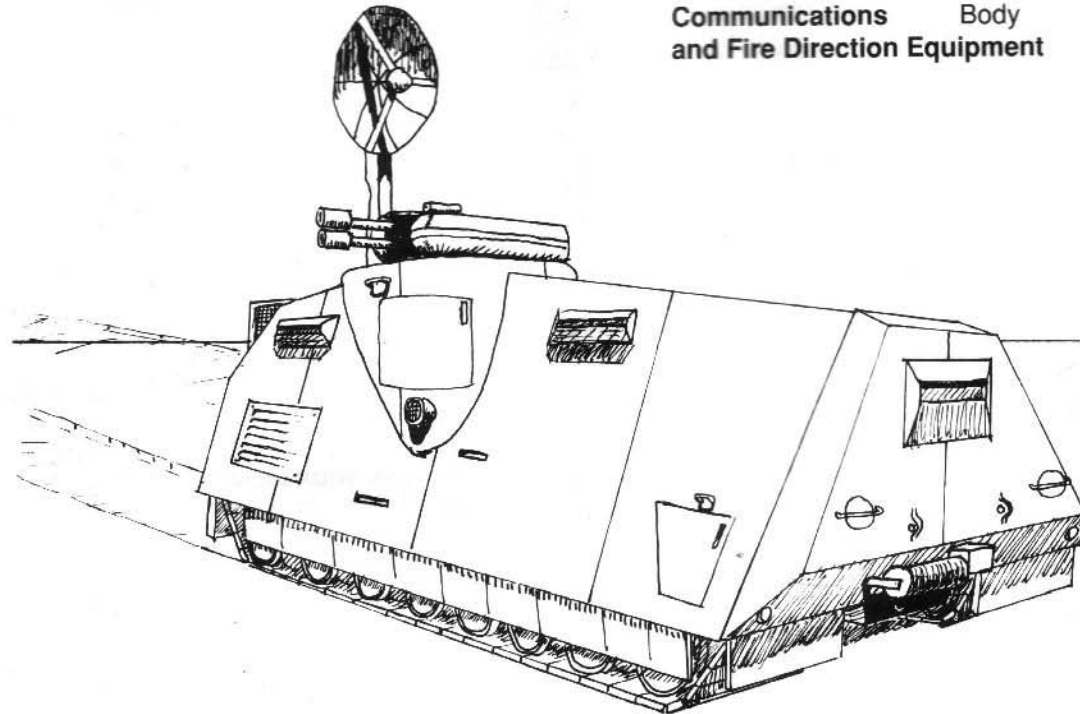

UNLEASH YOUR IMAGINATION...

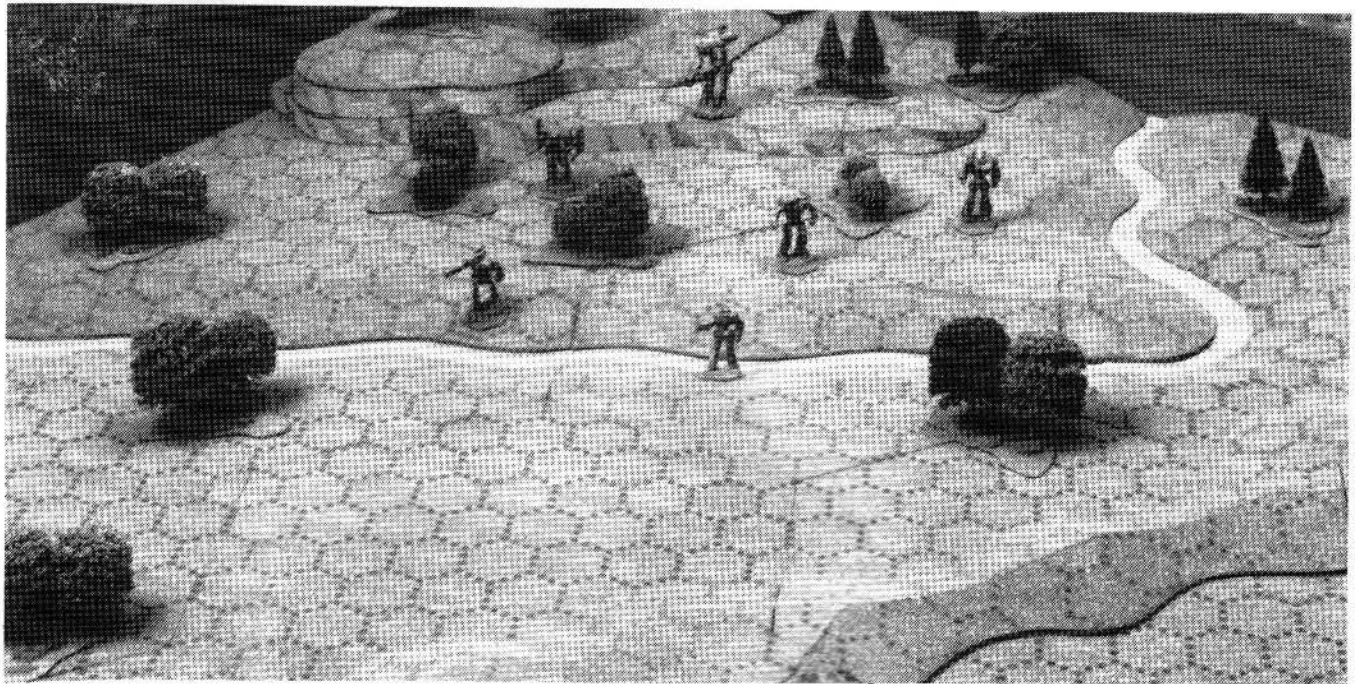

**DEALER
INQUIRIES
INVITED**



**\$99.95
PER SET
58 PCS.**

Tired of playing your game on the same old board? Move up to the world of 3-D terrain simulation with *BATTLESCAPE™* from GEO-HEX. Based on our award winning and critically acclaimed GEO-HEX™ Terrain Simulation System, *BATTLESCAPE™* is both a flexible terrain display system for miniatures and hex grid gameboard rolled into one.

NO ASSEMBLY IS REQUIRED !!

Covered in your choice of either grass green or desert sand flocking, each *BATTLESCAPE™* set comes completely finished and ready for use. Now you can model streams, rivers, hills, islands, cliffs, etc., from the moment you open the box. And while the unique, patented shapes allow you to create an endless variety of landforms, the overlying 1.5 inch hex size grid allows you to use boardgame rules and movement systems. So leave flat, featureless gameboards behind; ask your local hobby dealer about us or contact us directly at the address below, and enter a realm of adventure with *BATTLESCAPE™*!

**609 NE Schuyler, Unit #1
Portland, OR 97212**

New Address:

**(503) 288-4805
Contact KR**

A COLOR CATALOG OF OUR FULL LINE OF TERRAIN PRODUCTS IS AVAILABLE FOR \$3.00 U.S. VISA AND MASTERCARD HOLDERS CAN CALL, OTHERS SEND CHECK OR MONEY ORDER.

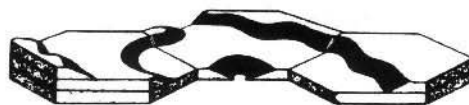

GEO-HEX™

IF ORDERING FROM THIS AD PLEASE INCLUDE SHIPPING WITH ORDER. US. SHIPPING, 5%; CANADA, 12%; OVERSEAS SURFACE, 15%; AIR 30%. ALL PAYMENTS IN CURRENT U.S. DOLLARS. PRICES SUBJECT TO CHANGE WITHOUT NOTICE.

And Furthermore...

Announcements

We're Looking For A Few Good Mercs!

Thornhill Arms, the leading edge in personal defense technology, has a number of openings in its expanding corporate security division. Line security troops (preferably in units of five or more) to provide protection for its extensive retail and distribution network as well as a few elite 'Mech and Aerospace units to garrison its hidden manufacturing facilities are needed. All applicants must be willing to relocate (at Thornhill's expense), provide confirmable references, sign non-disclosure agreements, and submit to deep hypnoprobing*. One, two, five, and ten-year contracts, as well as open-ended contracts are available, all with very competitive salaries with full benefit packages. Rates are flexible, based on past experience, length of contract and nature of the specific assignments. 'Mech and Aerospace units will be offered the opportunity to participate in Thornhill's ongoing efforts in the fields of BattleMech and Aerospace Fighter research and development. Such participation is purely voluntary, though it is rewarded with extra compensation. Security Forces will be outfitted with standard Thornhill Arms equipment. 'Mechs and Aerospace units will be expected to provide their own vehicles, but can call upon Thornhill stockpiles (access negotiable). Interested parties should request a standard application form from their local licensed Thornhill Arms Distributor. Make the jump to your future with us. We're

Thornhill Arms

Preserving the Past to Ensure the Future
An equal opportunity employer

*Hypnoprobing to be conducted by a joint team of Thornhill Arms and ComStar MedTechs.

BattleTech Miniatures

If you paint them, bring them by the BattleTechnology corner of the Pacific Rim Booth.

Or at the conventions which are starred * like this, look for our time and place announcements in the convention program or the convention announcements bulletin board.

We photograph your figures and publish the best of what we photograph.

This year :

DunDracon

Origins

Fresno Games Con*

Gateway

Pacificon*

Next year:

DunDracon*

Origins

Watch this list; we will be adding to it in our next issue

Letters

...I appreciate your efforts and wish to say that without BattleTechnology, today's MechWarrior would lack perspective and fall prey to the house propaganda officials who feed us the lies procured by desperate men.

Sincerely,

Garret Hayre, Fire Lance Commander
Reaper & Hayre Company

...Quite frankly, I am pleasantly surprised that you can still manage to keep your publication in operation in spite of the hardships of war. The interview of Maximilian Liao by Svetlana Chan in the June 3028 issue was certainly enlightening as to the true depth of his megalomania. One can only hope that the Federated Suns Forces put an end to this threat to mankind.

All of the members of the heavy metal company, of which I am a staff Sergeant (piloting my Warhammer "The Yellow Rose"), find that the news that you report is an unbiased and factual review of the events throughout the Inner Sphere. Keep up the good work!

Sincerely

SSgt David Sanders
Heavy Metal Company

Among the Missing?

The following a MechWarriors have been reported by our subscription department as unfindable. BattleTechnology sincerely hopes for the safety of each of you. If you are alive and well — or if you know the whereabouts of somebody mentioned here who has not seen this listing, please contact our Terran office. Federated Suns citizens — we do accept physical mail as well as ComStar transmissions.

Mayer Brenner
David Brungardt
Timothy Caretti
Sgt Michael Cox

Jim Fleisher
Duane Gould
Bobby Howell
William Hutchins III
Matt Jewett
David Lautzenheiser

John Pelkey
Charles Thompson
Marc Tierney
Andrew Wick
Raymond Yeen
Robert Zemansky

The Snows of Battle

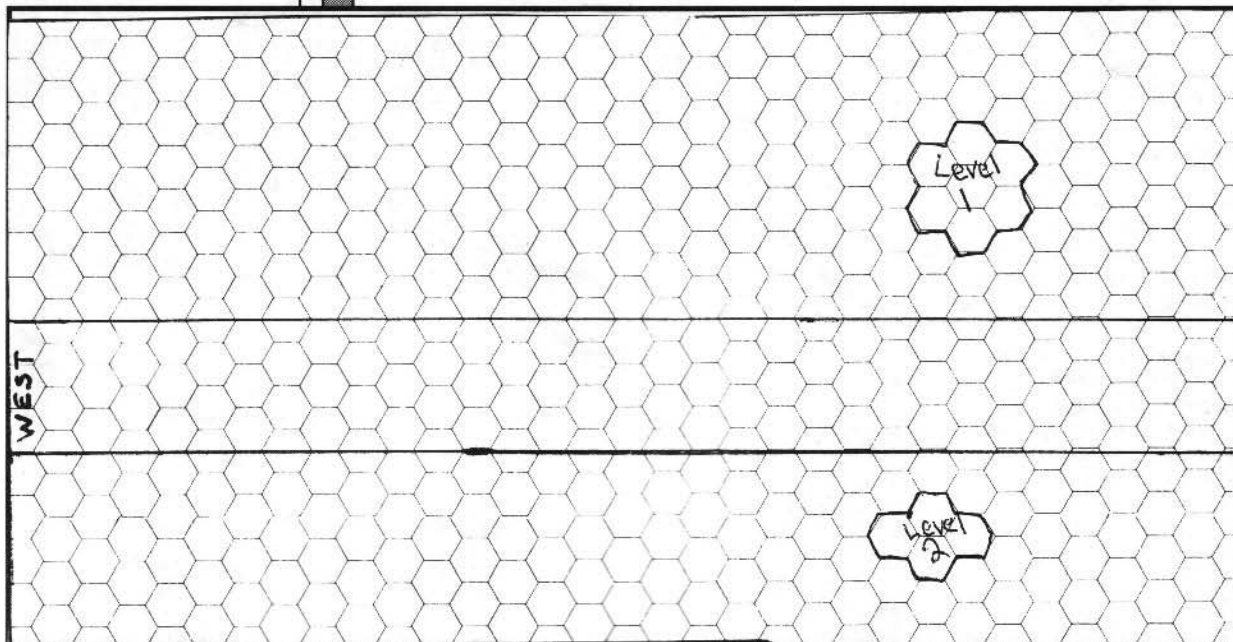

Victory Conditions:

Defender: wishes to disable or destroy the three 'Mechs. He also wishes to survive, and has very little chance to do so.

For each 'Mech disabled or destroyed: 5 victory points.

For each vehicle or unit retreated after the first enemy 'Mech disabled or destroyed: 2 victory points.

Attacker: wishes to disable or destroy the militia units and vehicles.

For the Patton destroyed or disabled: 5 victory points

For each Pack Rat destroyed or disabled: 3 victory points

For each infantry group destroyed: 1 victory point

If all Attacker 'Mechs able to walk away afterwards: 2 victory points

Decisive Victory: 15 pts

Victory: 10 pts

Marginal Victory

Larger Number of Points
(under 10)

This action took place during the recent fight for the Liao planet of Second Try. This icy world kept its Davion garrison constantly fighting to maintain their conquest for well over two months, an amazing record when it is realized that the planetary force consists of five militia battalions, and three poorly maintained *Shilone* fighters.

Attacker:

Three 'Mechs from the Twentieth Avalon Hussars:

Sgt Henry Trailleur, *Hatchetman*
Piloting: 4, Gunnery: 5
3 points armor missing from center torso

Mechwarrior Dick Vocoeur, *Ostscout*
Piloting: 3, Gunnery: 4
6 points armor gone from right leg,
right leg actuator damaged, -2 mps

Mechwarrior Marcel Waters, *Stinger*
Piloting: 5, Gunnery: 3
No damage

Sharpstone Foothills, Second Try Feb 18, 3029



Defender:

Squad six, Autumn Frost district militia:

Patton Tank
Piloting: 5, Gunnery: 4
Pack Rat #1
Piloting: 3, Gunnery: 5
Pack Rat #2
Piloting: 5, Gunnery: 3

Two eight-member militia units, armed with rifles and one SRM-2, no reloads

Squad 1: Gunnery: 3 (has the SRM),
Squad 2: Gunnery: 5 (rifles only)

Setup:

Defender infantry in position anywhere on board from west edge to the small hummocks. Patton on small hill. Two Pack Rats enter 1 d6 plus 2 and 1 d6 plus 3 hexes ahead of attacker along road. Attacker enters that far behind the closest Pack Rat. In the original action, the Pack Rats split and took cover behind the hummocks on either side of the road. Defender need not repeat that move.

Special Conditions:

Patton is visible only on a roll of 11-12 until it fires or attacker gets beyond it. Infantry is not visible until they fire. All heat calculations are made at a minus three. It was -13 degrees Centigrade that day in February.

Marcel Waters,
Twentieth Avalon Chasseurs
Debriefing, February 19, 3029

We saw them parked beside the road, eating lunch out of little boxes. Two Pack Rats, with camo paint the wrong color for the terrain. You know militia. We'd been looking for the Autumn Frost bunch for weeks — they had the last operational tank in the district. You've got to admit they made good use of it. Mostly against other infantry, or our mechanized support groups. Taking out a 'Mech! Doing serious damage to another! We didn't expect anything like that.

I could say that our unit wasn't prepared for the climate. We didn't have winter issue uniforms, not for that weather. We didn't have the right lubricants and coolants. Can you imagine a 'Mech fight where you don't need to keep your eye on the meter?

You know, my fighting style is to keep on the move. I jump a lot and I keep my weapons active. I have to watch my heat all the time. So for once I can move when I want and fire when I want. I'm just getting into it when I catch my Stinger's foot on some burning wreckage and shut down from heat overload after all!

...Yes, we'll remember Second Try for a long time. But miss it? Not for one little minute!

Northwind

From Interview, Lt Kahil Holt, Team Banzai
February 18, 3029,
interviewed by Maddelena Brandt,
BattleTechnology Weekly News

BT: About the 'Mech, Lt Holt?

Holt: The modified Rifleman, yes.

BT: There's a lot of advice on the battlerecorders over the last several days of the fighting concerning this experimental 'Mech.

Holt: Yes, Doc Banzai...(swallows) the Doc was testing a new type of heat sink. My lancemates gave me all kinds of grief about it. The advice was mostly, "Don't let it overheat!" It's a powerful 'Mech, but it's a hot one.

BT: During the action at the river island, didn't you run into problems with the 'Mech?

Holt: (Flushing angrily) If you call it a problem when my 'Mech shuts down while the snakes are slaughtering us! I could determine the position of the two larger 'Mechs with my MAD. They were hidden on the island, but there was so much noise I couldn't tell anyone. I had to watch the Battlemaster from the Bravos walk right into the trap, and I couldn't move!

BT: What was the noise?

Holt: Everybody was yelling! The Highlanders were chasing down four 'Mechs, just the two of them, screaming something in Gaelic; I heard later it was "Blood for blood revenge!" Look, we were from three different units; we had only time to set one frequency between us. There was no clear line of command...

BT: You got control of your 'Mech back and then...

Holt: Then I got into the rhythm of it, and used the Rifleman right. You have to move and fire, move and fire. Then you can burn out a nest of murdering snakes. Are you reporting what they did to Dr Banzai? Are you telling what they did to those two cities, poisoning their water with bacterials? Are you?

BT: We'll be reporting those incidents, yes. Any last words about the Rifleman? Remember, some of our readers may be in those modified 'Mechs soon!

Tales Your Mother Never Told You

This scenario represents one of the most interesting small battles to take place during the fight for the planet of Northwind. Six routed 'Mechs from the 36th Dieron Regulars chose to make a stand in a gully with steep walls. They were able to hide two of their most powerful 'Mechs until opponents were upon them. Had they faced enemies who were less able or less motivated, the history of this action might have been different.

Game Set-Up:

Lay out BattleTech maps as shown, or use blank hex paper. All land terrain is rough, representing the dangerous footing at the bottom of the ravine.

Defender:

The defender represents elements of the 36th Dieron Regulars. They are routed troops, and so demoralized. All 'Mechs have taken some damage.

Lt Daniel Shane, *Wolverine* :

Piloting 3, Gunnery 4 (AC 5 gone).

Sean Crane, *Hunchback* :

Piloting 5, Gunnery 3 (Left Arm inoperable).

Mikial Zortek, *Panther* :

Piloting 3, Gunnery 4 (3 heat sinks destroyed).

Dack Carawthord, *Javelin* :

Piloting 3, Gunnery 5 (sensor hit, + 1 to to-hit roll)

Mick Stevens, *Locust A* :

Piloting 3, Gunnery 2 (2 pts armor gone from CT, 1 from LT)

Rick Stevens, *Locust B* :

Piloting, 3, Gunnery 5 (3 pts armor off RT, 1 off CT, 2 off LT)

Defender Set-up:

Wolverine in Level 2 area or on island.

Javelin on Level 3 area or on island.

Other 'Mechs are around Lake in various positions.

January 12, 3029

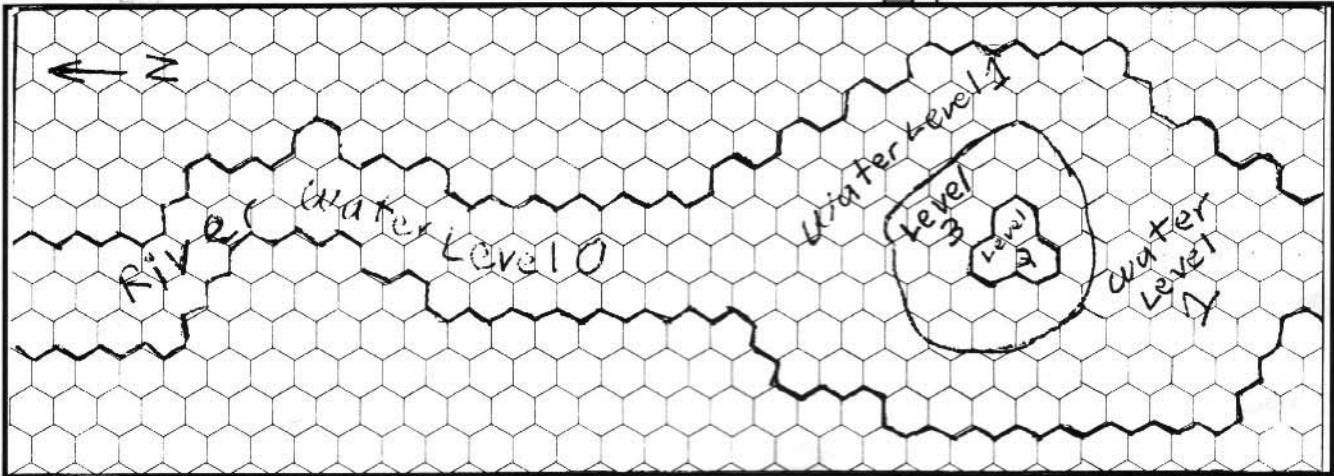

Attacker:

Attackers consist of elements from Team Banzai, Bradley's **Bravos**, and Marion's Highlanders.

- Samuel Trath, Bradley's Bravos, *Battlemaster* :
Piloting 3, Gunnery 3, SRM 6 gone
- Kahil Holt, Team Banzai, *Modified Rifleman* :
Piloting 2, Gunnery 1, no damage
- Doug McLain, Marion's Highlanders, *Archer* :
Piloting 3, Gunnery 5, 6 pts armor gone, LT
- Hanse Forrester, Marion's Highlanders, *Vindicator* :
Piloting 3, Gunnery 2, Left Arm gone

All attackers but the Rifleman enter from North end of the board at the same time. The Rifleman shows up two turns later.

Victory Conditions:

Neither side will back out of this battle. The Highlanders have just heard of the use of bacterial warfare on their civilian population; Dr Banzai is badly injured; the Bravos took a pounding earlier, and now all are out for blood. If the 36th Dieron Regulars win this fight, they will escape to their DropShips and be able to leave Northwind. The attackers will fight until all defenders are dead. The defenders will escape at all costs.

Modified Rifleman

Item		Tons
Mass:	60 tons	60
Internal Structure:		6
Engine:		11.5
Walking MPs:	4	
Running MPs:	6	
Jumping MPs:	0	
Heat Sinks: (2 are double)		
	12	2
Gyroscope:		3
Cockpit:		3
Armor Factor:	120	7.5
Head:	3	6
Center Torso:	20	22/4
Rt/Lt Arm:	10	15
Rt/Lt Torso:	10	15/2
Rt/Lt Leg:	14	12

Weapons & Ammo

Type	Loc	Crit	Tons
Large Laser	RA	2	5
Large Laser	LA	2	5
PPC	RA	3	7
PPC	LA	3	7
Medium Laser	CT (R)	1	1
Medium Laser	LT	1	1
Medium Laser	RT	1	1

Death of a Regiment

Before the Battle...

Battle Recording: interlance dialogue
Ninth Pesht mechwarriors

Mann: Those pointy-eared devils are not going to get the best of us, gentlemen. What I think we'll do is to cross the river about half a klick up and come around behind them to cut off their line of supply.

Hakimoto: *Sho-i*, MAD is detecting 'Mechs in front of us. ASSAULT 'Mechs!

Mann: Are they friendlies?

Kitakami: I've got visual, *Sho-i*. No, not friendlies. They're those bleeding Tyr!

Hakimoto: Why do we always get the short end of the stick?

Mann: Gentlemen, a variation of the Hans and Fritz maneuver! You go up the front end; I'll come round the back. I'm changing form.

Kitakami:

*Rain death from above
Dragon meets with Tyr canary.
This yellow bird dies.*

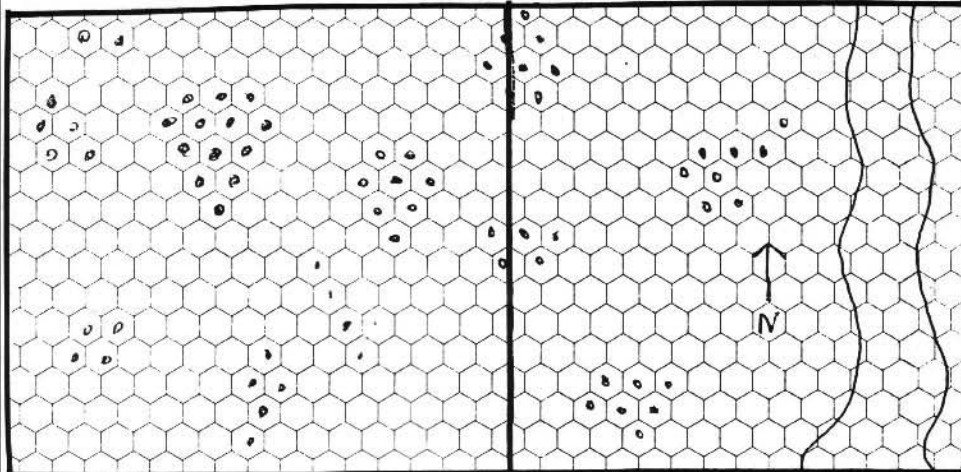

Background:

On this date a Tyr underground assault regiment attacked the poorly equipped and undersupplied Ninth Pesht Regulars. This particular scenario is a part of that battle. Late in the afternoon, a lance of Tyr assault 'Mechs crossed the river a kilometer north of the actual ford to cut off any evading 'Mechs that might have broken away from the battle. Before they could take up their positions they ran into two 'Mechs and a LAM from Mikaru's Company of the Ninth Pesht Regulars.

Game Setup:

Set up two BattleTech boards running east to west. A river is running north to south near the far eastern edge of the board. The terrain is light woods with patches of heavy woods interspersed. (Only the patches of heavy woods are shown on the map). The river is level 1 water, and the two hexes on either side of the river should be considered rough terrain to represent the muddiness and steepness of the riverbank.

Defender may set up anywhere on the eastern board west of the river, but he must remain two hexes away from the river.

Attacker sets up on river or on either side of it within two hexes of the river. Since the defenders were surprised, the attacker has the initiative for the first turn.

Defender:

Defender represents the remains of Mikaru's Company, Ninth Pesht Regulars. These troops are all veteran. In 3025 they were listed as green, but they have seen heavy combat since then.

River Lule, Stanzach June 1, 3029

Sho-i Hans Mann, *Phoenix Hawk LAM* Piloting: 4, Gunnery: 5
Damage: 3 pts armor off left arm
4pts off center torso; right arm machine gun inoperable

Mechwarrior Kazuo "Kaz" Kitakami, *Jenner* Piloting: 4, Gunnery: 3
Damage: Gyro hit, plus two to piloting level
Center torso jump jet destroyed (Jump mps cut to 4)
Center torso missing 3 pts of armor

Mechwarrior Ben Hakimoto, *Panther* Piloting: 5, Gunnery: 3
Damage: head missing 2 pts of armor
center torso missing 6 pts of armor

Attacker:

Assault 'Mechs from a Tyr lance (designations of this mysterious group's units remain unknown: although names have been released to the press it is quite possible that they are pseudonyms or *noms-de-guerre*). These troops are elite.

Lt Talber Mangold, *Battlemaster* Piloting: 3, Gunnery: 4
3 pts armor permanently missing from head

Okama Nishi, *Warhammer* Piloting: 4, Gunnery: 3
6 pts armor missing from right arm
Sensor hit, plus one on to-hit rolls

Har Levinson, *Cyclops* Piloting: 3, Gunnery: 3
Engine hit, plus 3 to heat per turn
6 pts armor missing from center torso

Sean Mangold, *Marauder* Piloting: 3, Gunnery: 3
A/C 5 missing completely

Victory Conditions:

The defender must disable the attackers and/or escape off the western end of the board.

- For each enemy disabled, 5 points
- For each defending 'Mech off the board, 1 point.

The attacker must disable or destroy the defenders.

- For each 'Mech disabled, 5 points
- For each 'Mech destroyed, 6 points

Overwhelming Victory: 18-23 points
Victory: 8-17 points
Marginal Victory: 3-7 points
Draw: 1-2 points

...After the Battle

"Lt Talber Mangold", Tyr *Battlemaster* interviewed by Maddelena Brandt, *BattleTechnology Weekly News*

Lt Mangold: Our culture believes in honoring a brave enemy according to his own customs. So, this may be the first Tyr haiku ever recorded.

*A still forest day.
The Pesht were Kurita's brave.
Death came in Tyr's way.*

Brandt: How did the battle seem to you as it was occurring?

Lt Mangold: *Dir Drabbling ar Himla Bra!*

Brandt: What does that mean?

Lt Mangold: (with a grin) Er.. 'The battle was creative and memorable', young lady! Now, how about dinner?

THEY ARE COMING.

NOTHING WE HAVE CAN STOP THEM.

MICHAEL A. STACKPOLE

LETHAL HERITAGE

BLOOD OF KERENSKY • VOLUME ONE



A BATTLETECH NOVEL

From beyond the Periphery

comes a threat. A threat

whose power, speed, and

ferocity are unparalleled. A

juggernaut whose sole

reason for being is battle.

THE CLANS.

Humanity's only hope is for Davion and Kurita to stand side by side.

Lethal Heritage is the first of a new trilogy by Michael A. Stackpole, author of the *Warrior Series*. Look for *Lethal Heritage* in July where you buy games.

BATTLETECH is a Registered Trademark of FASA Corporation. Lethal Heritage is a trademark of FASA Corporation. Copyright © 1989 FASA Corporation. All rights reserved. FASA Corporation, P.O. Box 6930, Chicago, IL 60680.

FASA products are exclusively distributed by JM Games • Charl House • Station Road • East Preston • Littlehampton • West Sussex • BN16 3AG • England, and by JEDKO Games • 134 Cochrane Road • Moorabbin, Victoria • Australia 3189.

COMSTAR CENSUS

Did you ever.....

Are you now

Or have you ever-

military background?

Regular

Mercenary

Unit?

Do you study the words of the Blessed Blake? daily? weekly? only monthly?

To be certain that we are serving the needs of all of our readers, ComStar has asked us to undertake a census of our readers with every issue. You may submit this census anonymously, however one entrant from each issue will be chosen at random to receive a three issue subscription or extension with BattleTechnology's compliments; this entrant will be chosen from those census answers which include a return address.

- 1) Issue Number (enter "8").
 - 2) Are you a subscriber? (1 for yes, 0 for no).
 - 3) Male or Female (M or F)
 - 4) How old are you?
 - 5) How many people will read this copy of BattleTechnology, including you?
 - 6) Are you a MechForce member? (If not, and if you want to be, contact the FASA Corporation, Box 6930, Chicago, IL 60680. BattleTechnology and the MechForce are independent of each other.)
 - 7) How many years have you played BattleTech? (Including MechWarrior, BattleForce, CityTech, AeroTech, etc.)
 - 8) How many hours a month do you spend playing BattleTech?
 - 9) How many BattleTech books and modules do you own?
 - 10) How many BattleTech miniatures do you own?
 - 11) How many others play BattleTech with you? In order of 5=most, 4= second most, 3=third most, 2= 4th most, 1=least, and 0= I've never played it; rate which you play.
 - 12) BattleTech
 - 13) BattleForce
 - 14) CityTech
 - 15) AeroTech
 - 16) MechWarrior
- On a scale of 0= I hate it to 5=Wonderful, rate the contents of this issue.
- 17) News From the Home Front
 - 18) Blood on the Snow
 - 19) McKlostey's Valley
 - 20) Fighting Spirit
 - 21) The Price of Cannon Fodder
 - 22) Guerillas on Glenmora
 - 23) In Memoriam: Michael Hasek-Davion
 - 24) Kurita Slays Steiner
 - 25) Thornhill Arms Catalogue excerpt
 - 26) BattleTechnology News Service
 - 27) Tech Readout: Athena

- 28) Tech Readout : Flea-14
 - 29) Scenario: Tales Your Mother Never Told You
 - 30) Scenario: Death of a Regiment
 - 31) Scenario: The Snows of Battle
 - 32) Blueprint FLE-14
 - 33) More Than Warriors
 - 34) The Cover
 - 35) Interior Photographs
 - 36) Interior Artwork
 - 37) This census itself
- On a scale of 0= I hate it to 5=Wonderful, how do you rate the departments of BattleTechnology? (Not all departments are present in every issue.)
- 38) WorldBook
 - 39) Hiring Hall
 - 40) MechTacs
 - 41) Simulator: Scenarios
 - 42) Simulator: Tech Readouts
 - 43) Simulator: Rules Variants
 - 44) More Than Warriors
 - 45) Letters to the Editor
 - 46) Technical Fact Articles like *The Price of Cannon Fodder*, Mech Engines compared, etc.
 - 47) Action Accounts like *McKlostey's Valley*, *Mech Flush*, *Blood on the Snow*.
 - 48) Stories and Tales in the 31st Century like *Fighting Spirit*.
 - 49) Background material such as *Black Luthien*, *Pleasure Planet*, or *Solaris the Game World*.
 - 50) Personal arms data
 - 51) Combat arms data
- On a Scale of 1-5 where 1=a lot fewer, 2=some-what less, 3=about the same, 4=more, and 5=a lot more, would you like to see more or less of the following:
- 52) Single Combat Scenarios
 - 53) Lance-to-Lance Scenarios
 - 54) BattleForce Scenarios
 - 55) AeroTech Scenarios
 - 56) CityTech Scenarios
 - 57) MechWarrior Scenarios
 - 58) Coverage of House Davion
 - 59) Coverage of House Kurita
 - 60) Coverage of House Steiner
 - 61) Coverage of House Liao
 - 62) Coverage of House Marik
 - 63) Coverage of Periphery and its kingdoms
 - 64) Coverage of a specific region (like Raselhogue, Isle of Skye, Andurien...)
 - 65) Longer fact articles
 - 66) Longer Rules Variant pieces
- More about you
- 67) Do you consider yourself to be affiliated with a specific House? 1=no, 2=Davion, 3= Kurita, 4= Steiner, 5= Liao, 6= Marik, 7=Mercenary (primary allegiance is to your unit), 8 = Peripheral kingdom or regional alliance. If you answered 7 or 8, please specify which one. 1=yes, 0=no
 - 68) Do you play other board games?
 - 69) Do you play other role-playing games?
 - 70) Do you play other science fiction games?
 - 71) Do you read science fiction?
 - 72) Do you read fantasy?

INCOMING!!

In the next, action-packed issue of BattleTechnology...

- Interview with —Princess Melissa Steiner-Davion Her First Since the War Began
- Wolf's Dragoons: —The Rendezvous on Crossing Who's Left Alive As the Dragons Arrive
- House Marik —Survival in a Hard School Operation Dagger and Beyond
- Galt's Grenadiers —One Good Mercenary Unit that still fights for Kurita
- Hasek-Davion in Capellan Hands —Will they kill two in a year?
- VTOL Simulator Rules
- Plus other feature articles; regular columns; battle simulations; news from the Inner Sphere...

AND MUCH, MUCH MORE! DON'T MISS IT!

- 73) Do you read science fact?
- 74) Do you play the BattleTech Computer Game?
- 75) Does your household own one or more computers? 0=none, 1=1, etc
- 76-100) Not used this time.

Would you like to contribute to BattleTechnology? If so, please include name, address, social security number and area of interest/expertise with this census or separately, but include a stamped, self-addressed envelope for contributors' guidelines.

Is there anything you would like us to add that we don't currently include?

Is there anything you would like us to drop? If you'd like to be included in "Where were you when the 4th Succession War Started?", send a paragraph describing the place you were in and your response to the news. Imaginary replies taking place in other than the 31st Century will not be included. Do not delay your answer; we have thirty Terran Standard days until entries must be closed so that the article may be compiled.

BATTLETROOPS

A GAME OF URBAN MAN-TO-MAN COMBAT IN THE BATTLETECH UNIVERSE.

'Mechs take the glory. Men take the real estate.'



NEW!
A BOXED
GAME FOR
BATTLETECH

'Kick the Can' — slang for ambushing a 'Mech.

BattleTroops is the game of personal combat in the age of the 'Mech. A unique movement and action system can resolve large battles quickly and realistically. The game features all facets of combat in the BattleTech system, including man to man, man to 'Mech, man to vehicle, and the use of normal infantry, jump troops, gun emplacements, and heavy weapons.

Look for BattleTroops where you buy games!

BattleTech, BattleTroops, and 'Mech are trademarks of the FASA Corporation. © 1989 FASA Corporation All rights reserved. FASA Corporation, P.O. Box 6930, Chicago, IL 60680. FASA products are exclusively distributed by TM Games • Chart House • Station Road • East Preston • Littlehampton • West Sussex BN16 3AG • England, and by JEDKO Games • 134 Cochranes Road • Moorabbin, Victoria • Australia 3189