

Palladium Books® Presents:
A Complete Role-Playing Game

Nightbane®

By C.J. Carella



Warning!

Violence and the Supernatural

The fictional World of Nightbane® is one of horror, violence, and brutality as well as heroics and triumph. It is filled with supernatural monsters and other dimensional beings, often referred to as “demons,” many of whom torment, stalk and prey on humans. Other alien life forms, monsters, angels, gods and demigods, as well as magic, the paranormal, insanity, and war are all elements in this book.

Some parents may find the violence and supernatural elements of the game inappropriate for young readers/players. We suggest parental discretion.

Please note that none of us at Palladium Books condone nor encourage the occult, the practice of magic, the use of drugs, or violence.

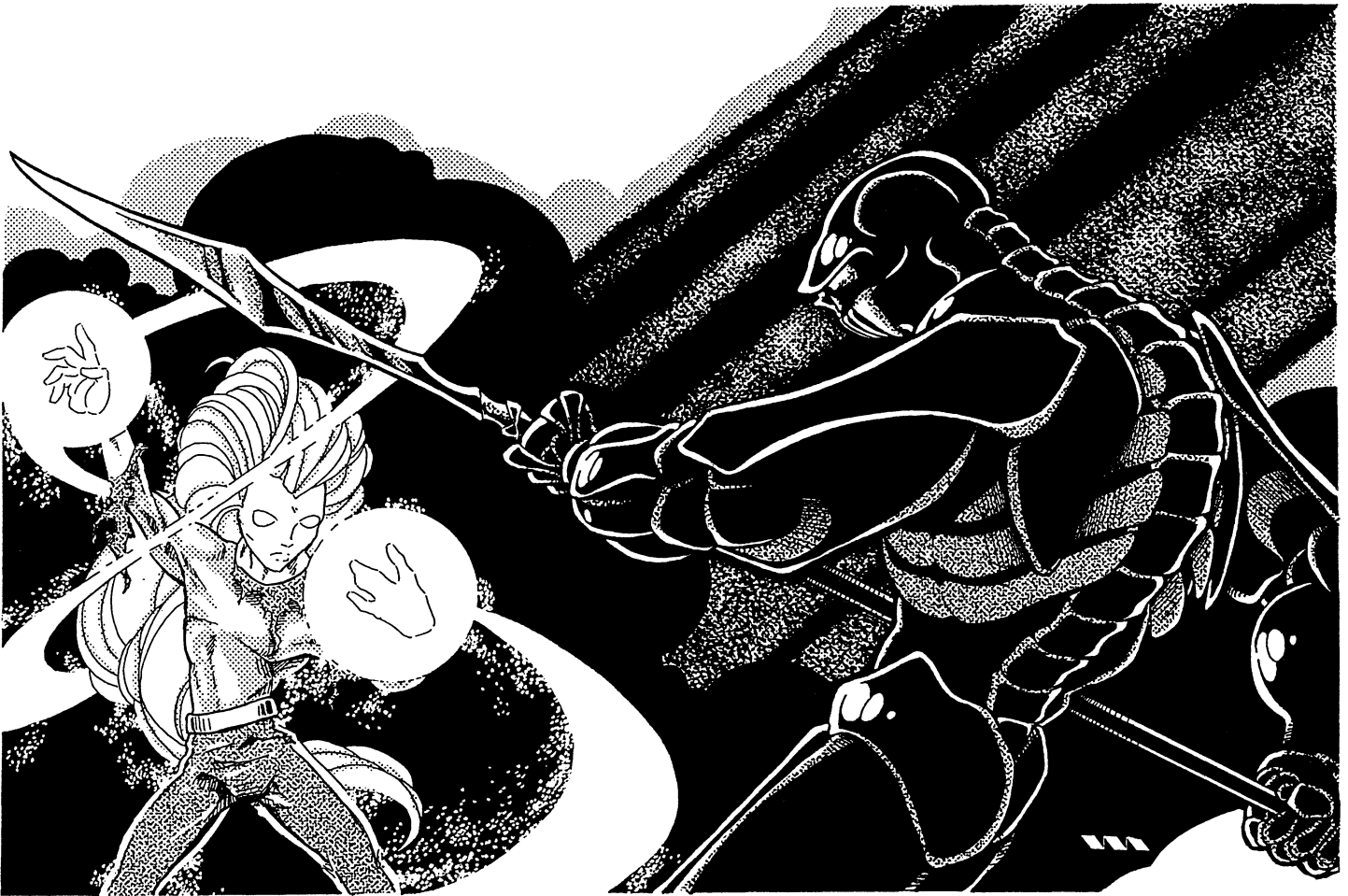

A complete role-playing game!

Compatible with the entire Palladium Books® Megaverse®!

Dedicated to my heroic play testers who helped me make this book better: Scott Coady, Joanne Fry, G.H. Metz, Chris Chevalier, and Bill Reich.

Carlos J. Martijena-Carella

PDF Edition – February 2018

Copyright © 1995 Palladium Books Inc.

Copyright © 1995 by Kevin Siembieda

All rights reserved world wide under the Universal Copyright Convention. No part of this book may be reproduced in part or whole, in any form or by any means, without permission from the publisher, except for brief quotes for use in reviews. All incidents, situations, institutions, governments and people are fictional and any similarity, without satiric intent, of characters or persons living or dead, is strictly coincidental.

Nightbane®, Rifts®, Palladium Books®, Phase World®, RECON®, The Mechanoids®, and Megaverse® are registered trademarks owned and licensed by Kevin Siembieda and Palladium Books® Inc. Nightlords™, Nightlands™, Hollow Men™, Beyond the Supernatural™, Wormwood™, Splugorth™, Naruni Enterprises™, the Coalition States™, and other names and titles are trademarks owned by Kevin Siembieda and Palladium Books® Inc.

The Nightbane® Role-Playing Game is published by Palladium Books® Inc., 39074 Webb Court, Westland, MI 48185. Printed in the USA.

**Palladium Books® Presents:
A Complete Role-Playing Game**

Nightbane®

Written By: **Carlos J. Martijena-Carella**

Game System and Additional Text: **Kevin Siembieda**

Senior Editor: **Kevin Siembieda**

Editors: **Alex Marciniszyn
James A. Osten
Kevin Kirsten
Julius Rosenstein**

Cover Painting: **Brom**

Interior Artists: **Vince Martin
Randy Post
Scott Johnson
Roger Peterson**

Character Sheets: **Michael O'Connor
Kevin Kirsten**
(Inspired by designs by Gordon Delp)

Art Direction & Keylining: **Kevin Siembieda**

Typography: **Maryann Siembieda
Michael O'Connor**



Special Thanks to C.J. for a new epic addition to the Palladium Megaverse®. To Brom for a wonderfully evocative cover. Randy and Vince for their moody artwork. And to Maryann, Kevin Kirsten, Jim, Alex, Steve, Mike and Julius for working such long hours to get this book to press.

Kevin Siembieda

Contents

Spawn of Night — An Overview	7
The Wanderer Diaries	7
What We Are	7
The Becoming	7
Shapes and Masks	9
The Lands of Night	9
The Lords of Night	9
The Servants of the Lords	9
The Invasion	10
Millennium of Shadows	10
Dark Day	11
Excerpts from Dark Day Afternoon	11
America After Dark Day	13
Forbidden Truths	14
An overview of dark dreams	14
What's Going On	14
The Nightlands	14
The Nightlords	15
The Conquest of the World	15
The Nightbane	15
Nightbane Factions	16
The Resistance	17
The Nocturnes	19
The Underground Railroad	20
The Warlords	21
The Seekers	22
The Lightbringers	23
The Spook Squad	25
The Others	27
Vampires	27
Sorcerous Orders	27
The Guardians	28
The Nightbane Lexicon	29
Time-Line	30
How to Play a Role-Playing Game	31
Glossary of Role-Playing Terms	32
Creating A Character	33
The Eight Attributes & Attribute Bonuses	33
Hitpoints & S.D.C.	35
Selecting a Character Class	39
Equipment and Money	40
Rounding Out One's Character	40
Alignments	40
Experience Points	43
Insanity 44	43
Skill List	48
Skill Descriptions	49

Modern Weapon Combat	60
Hand to Hand Combat	61
Combat Terms	62
Hand to Hand Combat Tables	65
Psychic Combat	65
Perception Rolls	66
The Horror Factor	66
Psionic Powers	67
The Psychic P.C.C.	68
Descriptions of Psychic Abilities	69
Psychic Sensitive Abilities	70
Physical Psychic Abilities	77
Psychic Healer Abilities	83
The Nightbane	85
Creating a Character	85
The Natural Powers of the Nightbane	85
The Nightbane R.C.C.	87
Basic Nightbane Skill Package	89
Resistance/Spook Squad-Trained Nightbane Skill Package	89
Trained Nightbane: Nocturne/Seeker/ Lightbringer Skill Package	90
Creating the Nightbane	91
Appearance Table	92
Nightbane Characteristics Table	92
Unearthly Beauty Table	92
Animal Form Table	93
Arachnid Table	94
Avian/Bird Table	94
Bat Table	95
Canine Table	96
Equine/Bovine/Deer table	96
Feline Table	97
Insectoid Table	98
Reptilian Table	99
Rodent Table	100
Snake Table	100
Stigmata Table	101
Unusual Facial Features Table	102
Alien Shape Table	103
Unnatural Limbs Table	104
Biomechanical	105
Nightbane Talents	106
P.P.E. and Talents	106
Alphabetical Nightbane Talents List	107
Common Nightbane Talents	107
Elite Nightbane Talents	113
Magical O.C.C.'s and R.C.C.'s	115
Sorcerer O.C.C.	115
Mystic O.C.C.	117

Nightbane Sorcerer O.C.C.	118
Nightbane Mystic O.C.C.	119

Magic	121
How Does Magic Work	121
The Return of Magic	122
The Mastery of Magic	122
Belief	122
Mental Discipline	122
Understanding Magic	123
The Pursuit of Magic	124
Magic Terms	126
Alphabetical List of Spells	126
Spell Descriptions by Level	127

Life After Dark	151
Earth After Dark	151
The Preserver Party	151
Law Enforcement & Crime	152
The Police	153
The NSB	153
Street Gangs	154
Technology	154
Computers & the Internet	154

The Nightlands	155
The Land	155
The City-States	155
The Waste	157
Crossing Over	157

Denizens of the Nightlands	158
Doppelganger R.C.C.	158
The Hounds R.C.C.	161
Hound Masters R.C.C.	162
The Hunters R.C.C.	164
Ashmedai	165
Namtar -- Hollow Men	167

The Waste Creatures	168
Waste Coyote	168
Snake Bird R.C.C.	169
The Lizard King	170

The Nightlords	171
Nightlord R.C.C. 173	
Ba'al-Zebul R.C.C.	175
Priest of Night O.C.C.	177

The Vampire Threat	178
Vampire intelligences	179

The Vampire R.C.C.'s	179
The Master Vampire R.C.C.	179

The Secondary Vampire R.C.C.	181
Wild Vampire R.C.C.	182

Vampire Powers	183
A Lust for Blood	183
The Vampires Bite	183
Slow Kill: Creating the Undead	184
The Passive Victim & Vampire Slaves	184
Mind Control: Vampire over Vampire	184
Psionic Powers of the Vampire	185
Metamorphosis	185
Summoning Powers	185
Limited Invulnerability & Super Regeneration ..	185

To Kill the Vampire	187
The Wampyr R.C.C.	188

The Guardians	189
A Mysterious Force	189
The Guardian R.C.C.	189

Campaigns & Adventures	193
From the Beginning	193
The Resistance Campaign	194
The Wanderers Campaign	195
The Discovery Campaign	196
The War of Light & Darkness	196
Historical Campaigns	197

Enemies & Minor NPCs	198
Preserver Activist ("Preevert")	198
Nightbane Gang Member	199
Corrupted Police	199
Night Cultist	200
NSB Agent	201

Using Other Palladium Books in Nightbane	202
Beyond the Supernatural	202
The Palladium RPG	202
Recon Modern Combat	202
Rifts	203

Weapons & Equipment	204
Ancient Weapons	204
Modern Weapons	209
Gases Grenades & Bombs	221
Miscellaneous Equipment	222
Vehicles	231
Special Gimmicks	232

Experience Point Tables	233
--------------------------------------	------------

Quick Find

The Becoming (intro) 7

Combat

Hitpoints & S.D.C. 35
 Coma and Death 37
 Hand to Hand Combat 61
 Hand to Hand Tables 65
 Horror Factor 66
 Perception Rolls 66
 Psionic Combat 65
 Weapon Descriptions 204

Dark Day

Dark Day (Greame Rogers) 11
 Dark Day (intro) 11
 Dark Day (America) 13
 Earth After Dark 151

Guardians

Guardians (Lightbringers) 23
 Guardians (intro) 28
 Guardians (main info) 189

Nightlords

Nightlord (main info) 171
 Nightlord: Minions (Denizens) 158
 Nightlord R.C.C. 173
 Night Princes 175
 Night Priest 177

Nightbane

Nightbane (Main Section) 85
 Nightbane Characteristics Tables 92
 Nightbane Gang Member NPC 199
 Nightbane Lexicon (Terms) 29
 Nightbane Powers 85
 Nightbane R.C.C. 87
 Nightbane R.C.C. (Creation) 91

Nightbane Skill Packages 8
 Nightbane Sorcerer 118
 Nightbane Talents (Powers) 106
 Nightbane Time-Line 30

NSB

NSB: Background (Conquest) 15
 NSB: National Security Bureau 153
 NSB: Agent NPC 201
 Preserver Party (intro) 13
 Preserver Activist NPC 198
 Preserver Party (Conquest) 15
 Preserver Party 151

O.C.C.s

Mystic O.C.C. 117
 Nightbane Mystic O.C.C. 118
 Nightbane Sorcerer O.C.C. 119
 Sorcerer O.C.C. 115

R.C.C.s & P.C.C.s

Ashmedai R.C.C. 165
 Dopplegangers R.C.C. 158
 Guardians R.C.C. 189
 Hounds R.C.C. 162
 Hunters R.C.C. 167
 Master Vampire R.C.C. 179
 Namtar – Hollow Men R.C.C. 167
 Nightlords R.C.C. 173
 Nightprinces R.C.C. 175
 Nightbane R.C.C. 87
 Priest of Night 177
 Psychic P.C.C. 68
 Secondary Vampire R.C.C. 181
 Wampyr R.C.C. 188
 Wild Vampire R.C.C. 182

Bane of Night — An Overview

Welcome to **Nightbane**[®], the latest addition to the *Palladium Megaverse*[®].

Nightbane is a dark fantasy game, set in a world beset by inhuman creatures that threaten humankind. Ironically, some of these creatures — the Nightbane — have become the defenders of the world. Feared and despised by most normal humans, the Nightbane struggle to survive and to fight the true monsters who have taken over the world. In this game, the monsters have quietly seized control of the government, the police, and the military. The average person does not realize this, however, and lives out his life without suspecting that he or she is nothing more than cattle for evil entities. The themes of this world are war and horror. War against the looming evil, and horror from within as well as from without.

The Nightbane grew up as normal humans, until the fateful *Dark Day* when their alien natures were revealed. Most of them are teenagers and young adults who now have to deal with the fact that they are superhuman beings, blessed with great powers and yet cursed to become outcasts. And on top of that, they must face the true inhuman evil of the Nightlords and their minions.

This game tries to combine heroic and horror role-playing. The Nightbane have strange and supernatural powers, but their enemies are just as powerful, if not more so. The player characters are scary and monstrous-looking, but may have more compassion and humanity than some of the humans they meet. Ultimately, they face terrifying foes in the guise of the Nightlords, vampires, demonic entities and, in many cases, their own inner demons, fears and desires. Their struggle promises to be long, and perhaps doomed from the start. Against all odds, they must expose and destroy the evil threatening the world, or die trying.

The Wanderer Diaries

The Wanderer Diaries is an underground publication, which claims to be the writings of an ancient *immortal being* from a race of supernatural entities known as the Nightbane. Believed to have been published with frequent updates since the late 20th century, the first copies of the Wanderer Diaries were released into the Internet in 1997. Hundreds of fragments, excerpts and quotes from the Diaries can be found on the Net today, many of them written after 1997; many people doubt that the more recent writings belong to the same person. Below are some excerpts from these books:

June 11, 2005

I look into a world of shadows tonight. Not five years before, the city would have been alive with light and noise. Technology had banished the fear of the night, the times when people would

huddle inside their houses and pray to their gods to prevent the things that walked the night from coming into their fragile domain. Now the few street lights shine upon mostly empty streets. One or two people walk hurriedly, nervously looking around, hoping they will make it home. I mutter a silent prayer for their safety. A few neon signs still glitter, but almost everywhere they are out, reminders of a happier time.

I will soon go out into the darkness. I have tasks to perform, and although I know monsters walk the streets tonight, I will not falter. For I myself am a monster.

I am Nightbane.

What We Are

(First published on May 8th, 2001)

It's been a year and a day since *Dark Day*, the coming of the Night into this world. Before then, our kind were few and far between, hiding in the shadows, or in plain sight, hiding our True Form from the eyes of unsuspecting mortals. A Neophyte could expect to be recognized and helped by an older Nightbane. Not any longer. So many of us have now appeared that there is little hope to educate them personally; not like the old days. For this reason, I am consigning these documents to the wondrous electronic network where information flows as freely as water. My younger friends will make copies everywhere, hoping that they will reach those in need.

Do you know what you are? Allow me to tell you.

The Becoming

You were — you thought you were — a normal person, just one more among the huddled masses of Humankind. Until the time of the Becoming. One day, your shape shifted and you became the stuff of nightmares and forgotten horrors. Maybe your form became animal-like, or grotesquely deformed, or some twisted fantasy of flesh and scrap metal. That day, your life changed forever.

The Becoming comes at different times for each Nightbane. For most, it occurs in the years spanning the time when you are no longer a child, yet not fully an adult. Sometimes, it occurs at a time of need — an accident victim, pinned beneath a carriage (or a car); a terrified child, facing death at the hands of a stranger; or a soldier at war, seeing the enemy coming over the barbed wire. More often, it happens at night, sometimes during your sleep (did Kafka know about us when he wrote *Metamorphosis*? I think he might have). Unlucky ones change in front of others and are branded monsters and freaks. In the old times, they were burned as witches or slain as demons. In the years before *Dark Day*, they were taken away by unsmiling men in dark suits and glasses, never to be seen again. Today, they risk far worse.



As to the rest — you all know the panic, the disbelief, the creeping insanity that comes when you see in the mirror the face of a stranger, an inhuman, misshapen stranger at that. Many a Nightbane has been overcome with madness, going off in a murderous rampage or taking his own life. The rest have managed to cope, and soon afterwards made an important discovery.

The Becoming is not absolute. One can shift back to one's original, human shape. Most of us do so and try to forget what happened. But sooner or later, the Morpheus will manifest again, in times of need, or when the power of that form tempts us into using it. Some of us choose to embrace our monstrous form and become true monsters, preying on the helpless until we are destroyed.

Shapes and Masks

All Nightbane are two in one, one mind inhabiting two shapes. We call the human form the **Facade**, the Lie, the human masque we thought was real until our transformation. The other one, the alien form that you will come to accept as your *true shape*, is known as the **Morpheus**. Over the centuries, I have come to feel that these names are themselves a lie, but they are convenient labels for something we cannot explain.

Our Facades retain most of the frailties of being human. They heal faster than a normal human and are highly resistant to normal maladies like disease, poisons and the elements, but by and large, they are not invulnerable to all normal dangers. The Morpheus shape, however, is powerful beyond measure. We can rend flesh, stone and metal with our hands, claws and teeth. We heal from injury almost as fast as it is inflicted and are impervious to most disease. In my time, I have fought on after having been shot multiple times, bayoneted by a dozen terrified men, even after losing a leg, sheared off by a cannonball. Except for the leg, all trifling matters — quickly passing discomfort, and even the leg grew back not long afterwards.

No two Morpheus are exactly alike. We are a race of strangers, each a new surprise to us all. Many of us believe that the Morpheus is a twisted *reflection* of our lusts and fears, of the good and evil in our soul. A pure soul, perhaps, would have a Morpheus of perfect beauty; the rest of us wear our flaws and foibles in the way our flesh is shaped.

Once the Becoming occurs, neither the Facade nor the Morpheus ages as mortals do. At the time of my Becoming, a Pharaoh ruled in Egypt and my own people hunted wild boar with fire-hardened wood spears. Today, I appear to be a man in my early sixties. We age only a year or two for the passage of every hundred, maybe even less.

But we are not immortal. We can die, by violence or accident. Although our Facades are frail and would seem to be our most vulnerable aspect, we can be killed in Morpheus form as well. If the cannonball that took my leg had hit me in the chest, I would not be telling you this story. Many a Nightbane has died a horrible death at the hands of the Roman Catholic Inquisition, for we healed as we burned, and took a long time to die. Since then, science has forged chains strong enough to bind us and weapons powerful enough to kill us. Magic has spells and rituals to imprison us, harm us, enslave us and finally destroy us.

If you die while wearing the Facade, your body corrupts and decays like that of any mortal human. If killed as your Morpheus, your shape dissolves in shadows like a mirage, leaving no blood,

dust or stain. So perhaps the Morpheus is the illusion, and the Facade real. Or maybe the Morpheus, not being from this world, leaves as soon as our wills are no longer there to force it to remain.

The Lands of Night

Over time, we discovered another world, apart from and yet linked to this one. This land of eternal night lies separated from the Earth by what we call the **Mirrorwall**, for mirrors are the gateway therein. All Nightbane can cross over by stepping through a mirror. At the other side lies a land where no sun or stars ever shine. Some of us believe that this is our home, the place of our birth.

But we are not wanted there.

Beware of the Lands of Night, for the **Nightlands** are grotesque mockeries of the cities of Earth. True monsters live therein, monsters and their victims. Unlike the Nightbane, they live for destruction and torture and they hunt us down whenever they find us. They are Hounds that wield cold Darkblades and Hunters that sweep down on the unwary. They are the minions of the Ba'al, the Lords of Night, who rule the Nightlands with an iron fist and hatred for our kind. Still, some of us find reason to go there. Ancient Artifacts of great power can be found or stolen in the cities, as well as the answers to many dark questions.

Between the cities lies the Waste, a barren desert where some of us have tried to make a home. **The Waste** is a dangerous place, full of strange monsters and beasts, some of whom belong to neither world. Yet, it is easier to live in the Waste than in the cities, although some Nightbane have made their home in both — but most prefer the empty plains of the Waste to the horrors of the cities or the dangers of Earth.

The Lords of Night

Cruel and heartless are the rulers of the Lands of Night. They are the *Ba'al-ze-neckt*, the Lords of Night. I have heard stories about their origins — but they must wait for another time. Suffice it to say that they bear Humanity — and our kind — nothing but hatred and malice. They wish to destroy the works of Man, to grind us into the dust, enslave us, and then sacrifice us to increase their power. And I say “us” because, in the eyes of the Nightlords, we and normal humans are the same, enemies to be subdued, enslaved and destroyed.

The Ba'al have great powers over the forces of nature, over cold earth and metal, lightning and fire. They can create *avatars*, lesser versions of themselves, and send them out to do their bidding. They are ageless, and perhaps immortal, but they fear the Nightbane, and from this fear I draw the hope that we may have the power to destroy them. They are our eternal Enemy.

The Servants of the Lords

The Ba'al have minions, countless hordes of them. Lowest of all are the Shades of the Living, called *Dopplegangers*, each the double of one man or woman in our world. Then come the *Hounds and the Hunters*, merciless metal-clad warriors who slay on command, or for pleasure. Over them rule the *Ba'al-Zebul*, the Night Princes, lesser Ba'al with the power of illusion, the tempters and deceivers of legend. Many strange creatures from alien worlds also serve the Nightlords, but the most dangerous are the *Ashmedai*, the Crawling Horrors, whose swiftly-changing

shapes conceal a monstrous form. And then are the *Nemtar*, small insects filled with malicious intelligence and able to create *Hollow Men* which they ride in like grotesque mounts.

All these, and many more, call the Nightlords their Masters. Even humans are counted among their throngs. Greedy and cruel men and women who have pierced the Mirrorwall separating the two worlds, and have made a pact with a Nightlord, exchanging their humanity for power. The worst are the **Nightpriests**, fanatical, evil beings, dangerous to all.

The Invasion

A year and a day ago, the skies of the world darkened unnaturally for an entire day and night. During that time, the Earth became as unto the Nightlands, and many a Nightbane endured

the Becoming. Dark Day was no accident, no freak of nature. It was an invasion, an attack led by the Nightlords. They have struggled to control of all the kingdoms of this world and make them their own. Now even the land of the free and the home of the brave is their playground.

The chaos of today's world, the fear and repression and senseless violence, they are the result of this invasion. Humans must fight or become victims of merciless monsters, both human and inhuman. Nightbane must fight or hide, or die at the hands of these true monsters. Perhaps, humans and Nightbane can join forces and battle this common enemy. Perhaps, one day we can even win. Perhaps.

I look at the dark streets below, and mutter a prayer of hope.

Millennium of Shadows



Nightbane[®] takes place in the near future, the early years of the 21st Century. The world is very much like our own, or at least so it appears to the average person on the streets. In this world, however, supernatural beings have invaded and covertly taken over every major government and many corporate powers on the planet. In this world, thousands of young men and women

have discovered they can transform into inhuman creatures of great power. Most live in hiding, their existence denied by the authorities and the "mainstream press," although not by the tabloids — in the 21st century, some of the tabloid headlines sharing space with UFO and Bigfoot sightings contain more than a grain of truth.

Dark Day

"It's... incredible. Ladies and gentlemen, night has fallen in New York City in the early morning hours! Uh, I can't see stars or the moon, just a solid sheet of darkness across the sky. I can't BEEPing believe it! It's not an eclipse. It's... it's the BEEPing end of the world, that's what this is! Hey, they ain't paying me enough money for this. I'm getting the BEEP outta here!"

— Anchorperson Mark Smith, Channel 7 Action News

Smith fell off the roof of Channel 7's building in his haste to run away. He survived and successfully sued Channel 7 and the City of New York.

Excerpts from *DARK DAY AFTERNOON*, by Greame Rogers

. . . . *Some say the riots were the worst part. Suddenly overtaxed by having to deal with both daytime and nighttime energy needs, electrical power systems without sufficient resources failed in several cities, causing brownouts and blackouts through the U.S. To make matters worse, most power outages occurred in the poorest sections of cities; people already deprived of hope were plunged into terrifying darkness. It's not surprising that so many people decided to take action against the system, the government, the laws of Nature, and even against themselves — all of which had forsaken or failed them once too often.*

The people whose power did not fail had the privilege of seeing night occur simultaneously around the world, from New York to Los Angeles, from Paris to Tokyo ... Newscasters in a hundred cities babbled incoherently about chaos and anarchy.

. . . . In New Berlin, Connecticut, fully one-third of the population committed suicide or murdered each other over the twenty-four hour period of darkness. The subsequent investigation (hampered by the fact that the chief of police shot himself after murdering his entire family) revealed that in most cases the victims watched the news of the blackout and then calmly switched their TV sets off and took their own lives, or slaughtered their friends and family. Similar incidents occurred in quiet suburban communities in the U.S., Canada, Europe. . . .

. . . . Then there were the monster sightings, the most widespread wave of reports of supernatural activity in recorded history. The overwhelmed (and themselves panicky) police departments and 911 dispatchers recorded thousands of calls claiming that inhuman creatures were prowling the streets. Seven videotapes (all later proved to be forgeries) depicted freakish creatures running, climbing walls and (in two very graphic tapes) attacking and tearing apart screaming people. Dark Day precipitated the largest case of mass hysteria ever known; even respected members of the scientific, military and government community "saw" these occurrences. Noted pop psychologist Dr. Rachel put it best: "Plunged into darkness, thousands of people reverted to their early childhood, when they needed the closet light left on so the 'bogey man' wouldn't get them. Deluded by fear, they started seeing bogey men everywhere. Things weren't helped by the twisted pranksters who put on rubber costumes to help fan the flames."

. . . . The scientific community remains divided about the causes. Three top astronomers committed suicide over the following month. One resigned his tenure and became a pig farmer,

saying "All I knew turned out to be a lie. At least pigs don't do anything you wouldn't expect them to." More sedate scientists tried to come up with an explanation. The most popular theory claimed the blackout had been caused by the release of some sort of opaque gas into the atmosphere, perhaps the handiwork of terrorists. The theory has raised as many questions as it answered, and nobody has been able to explain the satellite photos showing the entire planet had been covered ("shrouded," if you will) by a sphere of total darkness for the entire twenty-four period.

Dark Day occurred on March 6, 2000, at 6:02 a.m. Eastern Standard Time. The planet was enveloped in unnatural darkness for twenty-four hours, without warning or explanation. The darkness wasn't night, either, because neither the moon nor the stars were visible for the entire period. Panic broke out throughout the world, leading to the deaths of over 600,000 people. In the U.S. alone, an excess of 20,000 people died in riots, fires, car accidents and suicides. Millions of others suffered from both physical and mental trauma. TV newscasters babbled incoherently for several hours, until all radio and television stations were seized by the government and made to broadcast messages instructing people to remain in their homes and stay calm. A curfew was established in all major cities, but enforcing it became impossible. In many places, the police, National Guard and military were just as panicked as everyone else and complete terror and anarchy reigned.

By noon, six hours after the freak "eclipse" had started, most U.S. cities had suffered major fires and rioting. Many believed it was Judgement Day. It wasn't until the late afternoon that some measure of control had been reestablished. Even after the riots had been suppressed, reports of demons and monsters terrorizing the streets continued to pour in to the police departments. The government was quick to claim that *all* such "sightings" and "alleged incidents" involving monsters were either the product of mass hysteria or the actions of malicious pranksters or looters wearing costumes. It was later pointed out that many god-fearing people believed it was the end of the world, and therefore, it was natural for them to see demons and avenging angels, especially in a state of panic and hysteria. Yet many who claim to have witnessed carnage inflicted by monsters insist otherwise, and cry "cover-up" and "conspiracy." However, the majority of people cling to the theories of hoax and hysteria, preferring not to believe that such creatures could really exist. They and countless others, take solace in the fact that not one monster, living or dead, was ever found, making the claims by governments around the world more believable.

The next hours were spent in quiet, fearful vigil around the world, as people waited for the darkness to end — or to continue. Would the sun ever rise again? Was this the end of the world? Many suicides and other acts of desperation occurred during this period, as the hours slowly ticked by and the unnatural darkness lingered for what seemed to be an eternity rather than a mere 24 hours. Then, at 6:02 a.m. Eastern Standard Time, the sun (or moon and stars depending on one's geographic location) shone again. People cheered and cried with relief everywhere. Spontaneous parties and prayer broke out to celebrate the fact that the world had not come to an end. The crisis, they thought, was over.

They were wrong.

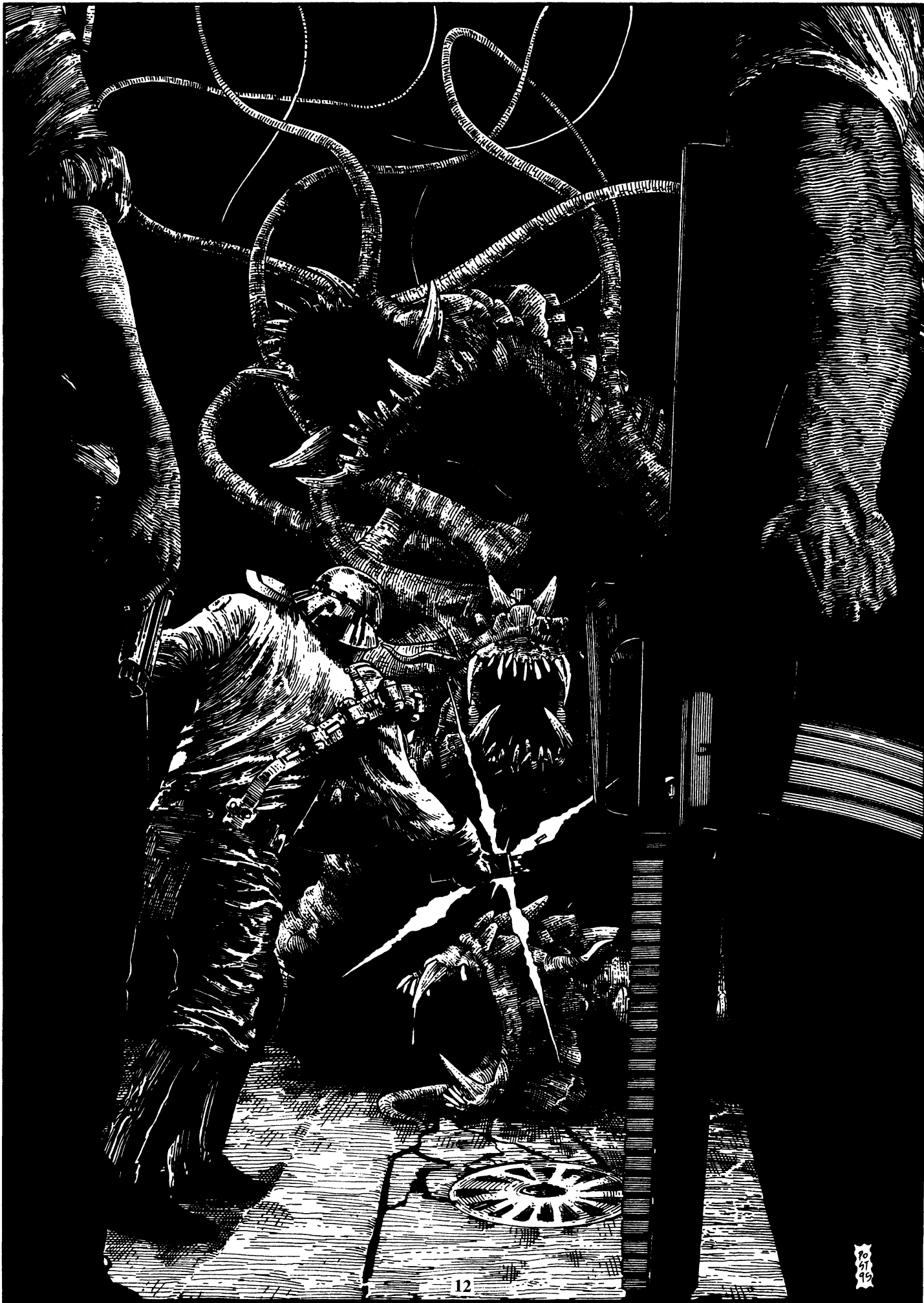

America After Dark Day

Things did not go back to normal after Dark Day. In fact, some commentators took to calling the year 2000 “the Year One, AD” — that is, year one, *After Dark*.

Although the light of day seemed to disperse most peoples’ fears, many remained terrified of the night. Some would not even venture out of their homes after sunset. Furthermore, monster sightings increased in frequency, particularly at night. Psychologists and government officials explained that the fear of darkness and “seeing monsters” that weren’t really there, was an after-shock of the intense fear and violence that occurred on the Dark Day. That many people were still suffering from a mild form of post-traumatic syndrome, paranoia, phobias and numerous other maladies resulting from shock and mental trauma. They insisted that these fears would subside and that the monsters were not real. They were wrong, at least about the monsters.

Starting at Dark Day, hundreds, perhaps thousands of people had become monsters. Most of them were young, ranging in age from thirteen to twenty. All of them were orphans, raised in institutions, foster homes, or adopted by normal families. They had led normal lives until their true forms manifested themselves. Each of these “monsters” had a unique form, always inhuman. Many were killed by terrified people, or killed themselves due to horror or panic. The rest were able to run away, hide, and later discovered that they could return to their normal human form. However, they would also learn that during times of stress, fear or desire, the change could reoccur spontaneously. They also sensed that they were not alone. That during the Dark Day, other “monsters,” like them, appeared on Earth. Even in human form, these “gifted” youths could sense the presence of others of their kind whenever they were nearby. They came to call themselves the “Nightbane” because it was at night that they were transformed — reborn.

Some of these inhuman survivors were able to forsake and contain the monster within, hide their nature from others, and lead a normal life. Yet somehow, even they were discovered and destroyed by either the police or other monsters that were systematically tracking down all are Nightbane. Running seemed to be the only way to survive, so the young Nightbane left their homes and fled into the cities, where they could hide better among the teeming millions.

The atmosphere of fear and chaos brought about major political reform in America (and around the world). A new political group, the **Preserver Party**, took advantage of the situation. The party’s platform was, “the preservation of American society at all costs.” It claimed that the current government had failed to protect the American public. Before Dark Day, Preserver candidates for the Presidency, Congress, and State positions had been running way behind in the polls. None had ever captured more than a 12% share of the voting public. After Dark Day, this changed dramatically. The Preservers’ numbers swelled as fearful people, including many who hadn’t bothered to vote before, joined the party. The majority were inspired by the Preservers charismatic leader, Presidential hopeful *Douglas Carson*. Meanwhile, the officers and candidates of other political parties seemed to be plagued by scandal, including the suspicious suicide of a major presidential candidate.

When November, 2000 rolled by, Douglas Carson had been elected president with 39% of the popular vote and carrying 31 states. Candidates from the Preserver Party managed to gain roughly one-third of Congress and became dominant in several states in the South, Midwest and Northwest. For the first time in the history of the U.S., a three-party system was firmly entrenched and a president from that “dark horse” group stood as the leader of the country.

Political analysts predicted that the government would become frozen by “gridlock” as the three parties all pulled in different directions. However, shortly after the new government got underway, many Republican and Democratic members of Congress and the Senate fell into line with uncharacteristic meekness, voting the way President Carson wanted them to vote, time after time. Rumors of blackmail, bribery and corruption soon swept the Capital. Reporters who tried to investigate the matter were frustrated by a lack of any evidence to support any such claims of impropriety. However, the situation became increasingly troubling when a number of investigative reporters met with accidents, madness or simply disappeared; more strange coincidences in a long string of unlikely happenstance.

Meanwhile, the new Congress started passing a number of laws designed to “reestablish order.” The new laws greatly reduced individual rights and included expanding police discretion to conduct searches without a warrant, a national ID card, gun registration and ownership restrictions. The new Congress also restructured the Secret Service, disbanded the NSA, and created a new security agency, the **National Security Bureau (NSB)**, with extremely broad powers and expansive jurisdiction. Less than a year later, the NSB “discovered” a massive plot by the FBI, CIA, and DEA to overthrow the U.S. government. The National Security Bureau’s probing investigations indicated that Dark Day and the growing crime-rate around the country was also part of the same plot. They also uncovered acts of alleged insurrection by, or corruption within, other government agencies. The public, long-accustomed to stories of government abuse and desperate to find somebody to blame for the Dark Day, believed the story. The NSB purged those agencies of “conspirators,” with scores of (innocent) government agents convicted of terrible crimes and executed as traitors or imprisoned. Others resigned and many vanished — fleeing justice and evidence of their guilt, according to the NSB. Some really did “vanish,” whereabouts unknown even to old allies and loved ones (presumed dead or imprisoned somewhere), but several hundred went underground, to be later featured on **America’s Most Wanted** as “Enemies of Society.”

In the year 2004, President Carson was re-elected with an amazing 76% majority of the popular vote. A number of newspapers and news agencies claimed that the elections had been rigged. Civil liberties continued to be restricted. Gangs of **Preserver Activists** (later known as “Preeverts”) started acting as unofficial terror squads, bullying and sometimes attacking people who made too much noise against the government. The *National Rifle Association* was one of the organizations to fall. The NSB continued making arrests left and right.

By 2006, President Carson announced he’d be seeking a third term in office, claiming that the current situation needed stable leadership, and drawing comparisons between him and Roosevelt in the 1930s and 40s. Reports continued pouring in

about strange goings on in the White House and the Capital, despite increased repression and news control.

And monsters continued to walk the streets after dark.



Forbidden Truths

An overview of dark dreams

What caused Dark Day and the chaos that followed? Where do the Nightbane come from? Most people don't have a clue. Furthermore, most would not believe the truth even if someone told them. This disbelief is one of the "enemy's" most powerful weapons. By feeding unsuspecting humans logical, believable lies, and pandering to their fears, they can keep them ignorant and therefore, helpless. Even many Nightbane do not fully understand the situation — until it's too late for them.

What's Going On?

The rise of the Preserver Party (and similar movements and organizations around the world) was not an accident, but part of a complex plan for world domination. Most of the people involved are unknowing puppets of inhuman beings from another world. A number of occultists, rebels and Nightbane have discovered where the conspirators come from and have some theories as to what they want.

The first discovery was that the alien world where the invaders originate is a lot closer than anyone would imagine. The Earth and the world, known as the Nightlands or Darklands, are like two layers of the same onion, touching but separate and independent from each other. For centuries, magicians and Nightbane had made contact and crossed over from one world to the other, but always in small numbers and with great difficulty. Dark Day weakened the barriers between the worlds, making the invasion easier.

The Nightlands

Bull sessions — all right, they call them "conferences" — at any Seeker gathering can be entertaining, especially if you keep your mouth shut and listen, like I was doing that night. The topic today was the Nightlands.

"Let's go over your ideas once more, shall we?" Doctor Rigauld said in an even tone. "Father Connally?"

"My gut feelings to the contrary, the Nightlands are not Hell, or a part of it," Father Connally's statement surprised all of us. After taking one look at the place, he had been convinced he was in the land of fire and brimstone. "The fact that these — Doppelgangers that live there seem to be replicas of people living on Earth indicates that this is not a place of the afterlife. Even my Baptist colleagues agree."

"And it's not any kind of spirit realm," said Hiroshi, our resident anthropologist. "The cosmology is all wrong. The inhabitants assume a physical form when entering our world. They are not insubstantial ghosts, kami, loa or any form of spirit."

"At first I thought it was some sort of 'dream world,' a creation of our own subconscious mind," added Professor Englund, shaking her head. "The place is too solid and complex for that, although the relation between our collective psyche and the place seems to be..."

*"Gentlemen," Doctor Rigauld interrupted. "And ladies, of course. So far, all you seem to be able to tell us is what the Nightlands are **not**. Can anybody give us any ideas or theories as to what it is?"*

I cleared my throat and got a dozen scientists, philosophers and occultists staring at me. Oh well, I thought as I spoke, that's what they get for getting a smartass as their token Nightbane.

"I'd say," I said. "That it is a nasty place to visit, and no way would I like to live there."

They were pissed, but they had to agree.

The Nightlands is a place of darkness and fear, much worse than Earth has become — although some fear that the goal of the invaders is to turn Earth into a place just like the Nightlands. It appears to be a cruel mockery of our world, with the same cities and places, even some of the same people, but all twisted and perverted. Monsters walk freely there, and humans are slaves and victims.

At first glance, an accidental visitor to the Nightlands might think he is looking down at the normal world sometime in the late evening. Cities sprawl much like their Earthly counterparts. But unlike normal cities at night, there are few lights. The sky is a solid sheet of blackness, just as Earth's was during Dark Day. This being the case, the land should be lost to pitch blackness, but somehow there is enough light to allow sight and to cast long shadows — a sort of dark twilight world. The humans and hu-

manoids living here are pale and sickly-looking. Many seem to be in a daze or lost to apathy. Horrible creatures randomly hunt them down and slay them, sometimes for food, more often for sheer pleasure.

Although nobody seems to know how, the Nightlands are so closely linked to Earth that most of the humanoid inhabitants of that dimension have a counterpart, an identical twin, living on Earth. Some occultists believe that the “humans” of the Nightlands took their shape from the dreams and thoughts of the “real people” in our world. They claim that the Nightlands are merely a reflection of our nightmares which have somehow been brought to life. Regardless of what they are, the Nightlands and their inhabitants are real enough to cross over to Earth and kill and terrorize just as they do on their homeworlds.

Note: More details about the Nightlands and their inhabitants can be found in the **Life After Dark Section** of this book.

The Nightlords

The rulers of the Nightlands are called the Ba'al, or the Nightlords. The Ba'al are sadistic, megalomaniacal beings with enormous power. Like the Nightbane, they have a Morpheus or true form (always a nightmarish, alien shape), but they can create multiple incarnations (called Avatars) which operate independently, and can assume any shape at will. These creatures have masterminded the conquest of Earth.

Their ultimate goals are a mystery to humans and Nightbane alike. They seem to draw strength from the Nightlands, and as the Earthlings become more frightened, paranoid and anarchistic, the Nightlands become stronger. It is possible that by making Earth more like their dark homeworld, they gain more power. It is also possible that they feed on the fear and emotions generated by humans. Or perhaps they are tired of ruling only the Nightlands and wish to expand their control over this new world called the Earth. It is just as possible that each Nightlord has its own goals and agenda.

Their major weakness is their fierce competition and paranoia. The Ba'al worked together to launch the invasion of Earth, but once it was completed, their cooperation ended, with each Nightlord carving his or her own kingdom on Earth. Backstabbing and conspiracies between the Ba'al are common enough to have come to the attention of the Nightbane and human resistance movements. They have found that sometimes the best way to destroy the Ba'al is to turn one against another. **Note:** More information about the Ba'al/Nightlords can be found in the **Life After Dark Section**; three of the most influential Nightlords in North America are described in the **Campaign Section**.

The Conquest of the World

Dark Day was no freak of nature, but the prelude to a secret invasion. Even before Dark Day, the Nightlords had secretly placed their agents on Earth. **The Preserver Party** was infiltrated and controlled by agents of the Ba'al almost a year before Dark Day. President Carson and most of his political appointees are not human beings at all; they are Doppelgangers: Nightlands bred counterparts to men and women living on Earth. The real Carson was killed and replaced years ago. In the months following Dark Day and Carson's election, more Doppelgangers were brought across and into towns and cities throughout America

(and the rest of the world). Key people in the police, military and government were murdered and replaced with look-alike Doppelgangers. Where no Doppelgangers matching the victims could be found, Night Hounds, other Nightlands monsters and even the avatars of the Nightlords took their places, using magic and natural abilities to disguise themselves. In addition, many humans have been bribed, coerced or intimidated into servitude.

The Preserver-controlled government became more repressive and authoritarian than any previous U.S. administration in history. Claiming to be fighting crime, the National Security Bureau (NSB) became incredibly intrusive and powerful; it has become a form of secret police not unlike the KGB of Communist Russia or the Gestapo of Nazi Germany. “The Feds are watching” has become a fearful catchword in everyday life. The free press is also a thing of the past. Most news agencies are controlled, influenced or manipulated to release only what the government (and the Nightlords) want. Some news reports have been suppressed in order to “prevent riots and civil disorder,” others squelched in the “name of national security.” Still others have been discredited with sudden and suspicious confessions, eyewitness reports, facts, and revelations that revealed the original report to be “incorrect” or “false” (in fact, many top reporters have had their careers ruined when they were “proven” to be unreliable, irresponsible, or downright liars). Many of the more outspoken reporters and journalists have been replaced with Doppelgangers, discredited, or killed in sudden “accidents.”

By the time of the Carson re-election, the U.S. was firmly in the grip of the Nightlords. The Federal Government was in the hands of King Moloch (see the **Life After Dark Section**). Local control over the U.S. is divided among three Nightlords subservient to King Moloch but often at odds with each other.

The goals of the Nightlords remain unknown. For the time being, they are content with securing their dominance over their new domain. Meanwhile, people keep disappearing or dying. This has led some occultists to speculate that many of these victims are being used as slaves, or perhaps sacrificed to an even more horrible entity: maybe the Nightlords serve some unknown power that demands such payment in pain and blood.

The Nightbane

“Let me tell you what I think we are,” Paulus, the oldest Nightbane in the group, said. “We are dreams made flesh, nightmares come to life. We are the walking embodiments of Human-kind's lusts and fears. They call us inhuman, but in some ways we are more human than they are, for we wear our true nature on the outside.”

“I respectfully disagree,” said Katya, absent-mindedly flapping her gossamer wings. “We are the bastard children of the Nightlands, and our power is to give shape to our souls. Our Morpheus is a pure soul, in all its beauty and horror, released into the world to do God's work.”

“Bull. I'll tell you what we are, kid,” said Creepshow. He flexed his hands and six-inch razor blades sprung from his leathery fingers. “We're badasses.”

Only a few facts are known about the Nightbane. They are shape-changers, with a human form known as the *Facade*, and a

monstrous form called the *Morphus*. No two Nightbane have the same *Morphus*; in fact, a few are beautiful in an inhuman way. All Nightbane are adopted children or orphans. Who their parents are, and where they come from, remains unknown to them. They are supernaturally strong and resistant to damage, have several different supernatural powers, and have life spans measured in centuries. They are able to travel freely into the Nightlands, either by walking through mirrors or through magical gates. They can also sense the presence of others of their kind, which is good because the Nightlords' minions mercilessly hunt down the Nightbane, neither giving nor asking for any mercy.

There are many theories and rumors about the Nightbane, especially among their own kind. Some say they are beings of pure energy that take human form in an instinctive effort to blend in. When a Nightbane is killed in *Morphus* form, his body dissolves into a pool of black light which dissipates in a manner of seconds, lending credence to that theory. When he dies in his human form, the *Facade* decomposes like a normal human body. Other occultists think the Nightbane have the power to manifest their soul or their personality in the *Morphus*. Their proof is the fact that the *Morphus*' shape is typically related to the fears, likes or dislikes of the Nightbane. Nobody knows whether either theory is right; a few think that maybe both are right and wrong at the same time.

Nightbane have existed for centuries before Dark Day. Some students of the occult believe that they were the result of accidental cross-overs. They were foundlings, children who were sometimes adopted by human families or even animals. Most Nightbane lived out their lives without suspecting their inhuman origins; they lived and died as normal humans, and their *Facades* decomposed with the passage of time. The few who had their identities revealed gave rise to the legends of demons, werewolves, changelings, and faerie children. These Nightbane discovered they aged very slowly and learned to use their supernatural powers and monstrous visage to their benefit; some for good, others for evil. In the dawn of history, some of these beings were worshipped as gods on Earth, and founded entire empires. Some of the animal-headed gods of Egypt and the mythical god-kings of Mesopotamia are believed to be Nightbane whose powers manifested themselves.

Eventually, awe gave way to fear. By the Middle Ages, the Nightbane were considered to be demons and hunted down everywhere. The ones who survived persecution lived in hiding, often traveling the world never staying in one place for long, especially as the passage of years did not tarnish their physical appearance. Some Nightbane formed secret societies and established a system of mutual assistance. The rules for these organizations were usually simple: Hide your *Morphus* from humans, do not harm humans unless absolutely necessary, and help any Nightbane you encounter. Safe houses, usually in the countryside, away from towns, were built by these refugees. Any new member of their race was approached quickly, usually as soon as his/her powers manifested and offered shelter and protection. Those who were Nightbane but whose nature had not been awakened were watched but left alone, since chances were they might never transform, especially if the change hadn't occurred by age 24.

Dark Day changed all of this. Before that time, there were only a few hundred manifested Nightbane worldwide. But the coming of the Dark and the mystical energies unleashed during the process caused every potential Nightbane in the world to be revealed through transformation. Thus, the number of Nightbane has increased a hundredfold. However, their awakenings did not all occur simultaneously. Throughout the Dark Day, approximately half of all the Nightbane in the world had manifested, while the rest remained unaltered. These late bloomers would "awaken" over the next year or so. Furthermore, since Nightbane abilities appear only after puberty, there are still thousands of unsuspecting children who will become inhuman beings over the next several years.

From the beginning, the minions of the Nightlords have tried to destroy the Nightbane. Even those Nightbane who made contact and offered their services to the Ba'al are usually eliminated! Many consider this policy to be insane, since such aggression leaves the Nightbane no option but to oppose the Nightlords and their hellish minions. Perhaps the Ba'al fear the Nightbane so much that they dare not allow them to live even as slaves or loyal soldiers at their side. This has led some to believe that Earth's salvation may lie in the hands of these unwanted children of the night.

Note: The specific powers and characteristics of the Nightbane race are fully detailed in the **Creation Rules Section** and the **Nightbane Section** elsewhere in this book.

Nightbane[®]

Factions

At first, the Nightbane were disorganized, traveling alone or in small groups, hiding from the authorities and giving little thought to anything other than their survival. Some of these independents are still out there, but they are the most vulnerable and short-lived, falling easy prey to the Nightlords and their minions. Eventually, however, the "newbies" or "nightbabies," as they are sometimes known, run into one of the larger groups of Nightbane. These groups, commonly called "the Factions," are loose organizations that operate on a regional, national, or even world-wide scale. The Factions vary widely in power, numbers, and goals. Some of them include humans, sorcerers and even vampires and other supernatural beings in addition to Nightbane.

Note to the G.M.: In a Nightbane campaign, the Factions can help provide focus and goals for the adventuring party. If all player characters belong to a Faction, they have a reason to work together and help each other. The Faction will provide the characters with a home, base of operation, allies, and missions. Of course, a particular Faction may have old enemies as well as acquire new foes, which may put the characters in danger because of their affiliation with the group. The Nightbane characters in

the player group could also belong to different Factions as well, especially those who have a history of working together. They might even belong to competing or antagonistic groups, which may lead to some interesting role-playing, but also to back-stabbing and bickering, so the game master should decide whether the players' temperaments are up to such a situation.

The Resistance

The Resistance is the largest Nightbane Faction, with members throughout the world and in nearly every city of the United States. The goals of this group are simple: To organize the Nightbane and oppose the Nightlords everywhere. They use sabotage, espionage and guerrilla tactics to achieve these goals. Many so-called "terrorist" actions against political targets are actually the work of the Resistance.

Originally, the founding members of the Resistance belonged to the **Underground Railroad** (see below). As the Nightlords continued their campaign of world conquest, however, they became tired of hiding and fighting only in self-defense. The rest of the group thought these radicals were foolhardy; what chance would they have against a powerful, well organized enemy? Better to protect oneself and let humans deal with their problems. Eventually, the differences between the two became too intense, and the aggressive Nightbane left the Underground Railroad to found their own group, the Resistance. Two of the leaders (see the **Campaigns and Adventures Section**) were veterans of World War II, so they chose to call their organization the Resistance, in honor of the partisan groups that fought the Nazis in occupied Europe.

Over the years following Dark Day, the Resistance grew in numbers, drawing frustrated members from the Underground Railroad and recruiting more young Nightbane. A few of the "old guard" Nightbane had amassed a considerable fortune over the centuries, and they used it to help finance the group. Former soldiers helped train the new members in guerrilla tactics

The Resistance is organized into "cells," small groups that operate more or less independently, and which do not know much about what the other cells are doing. This is a tried and true tactic to use in case they are captured and forced to give up information. Cells range in size from 3 to 10 members. The Resistance distrusts "norms" (as they call humans) as well as other supernatural creatures, preferring to rely on each other rather than outsiders who may have their own secret agenda. They are given missions and assignments through a complicated system of couriers, secret messages and codes. Resistance cells are also given a great deal of leeway to conduct their own raids and operations against the pawns of the Nightlords, or to recruit more Nightbane.

Campaign and Role-playing Notes

The Resistance is your basic "freedom fighter" group. Their missions and goals are simple: Destroy the enemy, disrupt the evil government, and save political prisoners (i.e. other Nightbane and those who fight for freedom). These goals are complicated by the fact that most Resistance members do not trust

humans. Resistance characters can be idealistic or cynical, depending on their experience. Many feel forced into the war against their will and are bitter about it. Others learn to relish the violence and excitement, or are dedicated to destroying the Nightlords and restoring some semblance of true peace and freedom to the world. Having player characters join the Resistance works well for gung-ho players and characters. Action and intrigue will be the order of the day.

Relations with the Other Factions

The Resistance has a lot of contact with other Nightbane groups, but are always trying to recruit people away from the other organizations, which sometimes causes problems.

The Nocturnes: The Nocturnes have many non-Nightbane members, so the Resistance instructs its people not to trust them, despite the fact that they share a common enemy. However, many Resistance cells have found themselves working alongside the Nocturnes, so the relations between the two organizations depend on the individuals involved. Nightbane in the Resistance discovered giving information or overt aid to the Nocturnes (especially human operatives) can get in trouble with their organization's leaders.

The vampire presence among the Nocturnes is what worries the Resistance the most. Some Resistance members believe that the organization is nothing but a puppet of vampire intelligences. Most Nightbane rightly regard vampires to be just as evil and dangerous as the Nightlords.

The Underground Railroad: The members of the Underground Railroad are considered to be cowards, hiding out while the Resistance tries to save the world. The old guard Nightbane that control the Railroad are living in their own little world in the eyes of most Resistance members. Despite this animosity, there is a great deal of contact between the two groups. Recruits for the Resistance are frequently discovered or rescued by the U.R. before they move on to other Factions. Even the Resistance has to acknowledge the Underground Railroad's long history of helping young, terrified and confused Nightbane who have recently experienced the "Becoming."

The Warlords: This Nightbane-controlled gang is a danger to everyone. While the occasional Warlord gang will come to the aid of a Resistance cell, the Warlords are considered to be opportunistic criminals who won't hesitate to betray or attack their fellow Nightbane. Also, the illegal activities of the Warlords (including drug-running and protection rackets) only increase the fear and distrust humans feel towards Nightbane, which doesn't help the entire species. Since the Warlords often don't care to conceal their true natures, they are seen as violating the basic tenet of the Resistance (inherited from the Underground Railroad): hide yourself from humans whenever possible.

Fights to the death between Warlords and Resistance members are not uncommon, especially when the two groups are competing over new Nightbane "recruits," or when after the same item or territory.

The Seekers: Since this group is controlled by human sorcerers, the Resistance has as little to do with it as possible. The Nightspawn do not usually attack the Seekers because they are known to be enemies of the Nightlords, but members are cautioned not to work with them unless absolutely necessary. Down



“in the trenches,” of course, Nightbane will often work with Seekers, and some strong friendships and alliances have been forged between them.

The Lightbringers: The Resistance knows little about the Lightbringers, and they do not like what they know. The mysterious Guardians represent an unknown force with undetermined goals. Yes, they are fighting the Nightlords, but the question is, will they turn against the Nightbane after they win? The fact that some Nightbane belong to the Lightbringers does not mollify the Resistance leaders; those Nightbane could simply be unwitting pawns.

The Spook Squad: Another human-dominated group, the Spook Squad is controlled by ex-members of secret and security agencies across the world. Some of the older members of the Resistance have bad memories about those government agencies, many of which persecuted, imprisoned, experimented on, and killed Nightbane in the years before Dark Day. The feeling is mutual, so contact and cooperation between the two groups is at a minimal.

The Nocturnes

The Nocturnes seem to have existed before Dark Day, but nobody knows for how long. They are enemies of the Nightlords and are constantly attacking their servants and minions, and disrupting their plans. Their membership includes not only Nightbane, but also human sorcerers, vampires, wampyrs and other supernatural beings, including some other denizens of the Nightlands like Doppelgangers (see the **Life After Dark Section**). In fact, the Nocturnes have the highest number of vampires of all known Nightbane Factions.

The Nocturnes claim to have been founded by an ancient wampyr (see the **Vampire Threat Section** for information about the **Wampyr R.C.C.**) called *Iosef Pendragon*. Pendragon supposedly used an ancient magical ritual to sever his dependency on vampire intelligences, and was then able to slay his former masters. Since then, the vampire has organized a loose network of supernatural beings, sorcerers and occult investigators. Vampire members of the Nocturnes have foresworn killing their victims, and drink blood only for survival. It is not easy to deny their needs, however, and tragic losses of control are all too common.

For many years, the Nocturnes fought the encroaching vampire intelligences in a centuries-long cycle of victories and defeat. There is a rumor that claims that Iosef Pendragon is not an independent vampire but actually the willing pawn of a vampire intelligence who was using the Nocturnes to eliminate the competition.

With the coming of Dark Day, the Nocturnes found themselves facing a worse enemy than any vampire intelligence. Many of the Nightbane who belonged to the group were killed during the first chaotic days. Fortunately, the organization’s long tradition of secrecy allowed it to survive and strike back. The Nocturnes have even managed to disrupt the takeover of several cities in the U.S. and Canada, destroying the supernatural beings who had replaced key political figures, and doing so in such a manner that they could not be replaced quickly. Among their

kills were two Avatars of *Lady Nightmare* and one of *King Moloch’s*.

Over the years, the Nocturnes have gathered a great deal of occult knowledge. Most Nightbane sorcerers (see the **Nightbane Characters Section**) belong or used to belong to this group. They know more about the Nightlands than any other group and research/exploration teams often venture into that world to learn more, or to carry the struggle to the Nightlords’ lair.

Campaign and Role-playing Notes

Mystery and paranoia are important elements among the Nocturnes. Added to the weirdness of the Nightbane and their enemies are new variables: vampires, human occultists, and other supernatural beings. Although the Nightbane are monstrous, they do not need to hunt humans to survive. Vampires are an exotic, suspicious addition to the group. Vampire player characters are easy to integrate in a campaign dealing with the Nocturnes, but there are always problems. Vampires cannot operate during the daytime, restricting the movements of the entire group. Although Nocturnes have sworn never to kill innocents, a vampire can always lose control at the worst possible moment. Consequently, some player characters will never fully trust the undead creatures, and might even try to destroy them.

There is also the fear that the organization might actually be a tool of evil vampire intelligences. The player characters should never be totally sure about the true goals of the Nocturnes (they don’t have to be sure). For the time being, the Nightlords are so dangerous that it might be worth serving a lesser evil, like vampires, in order to get rid of them. Regardless of how a Nightbane or human rationalizes working with vampires, there is always likely to be a nagging suspicion about their allies and of what will happen when (if) victory against the Nightlords is achieved.

Relations with the Other Factions

The Resistance: The Nocturnes wish to help the Resistance, but there is too much suspicion between the two groups to create a firm relationship. The Nocturnes content themselves with manipulating Resistance cells, leaving clues for them so that they attack selected targets and basically pointing them in the right direction.

The Underground Railroad: These two groups have very little contact, except when they both go after a new Nightbane. The Railroad shares the same fears and suspicion as the Resistance towards vampires and supernatural beings.

The Warlords: The Nocturnes often deal with the Warlords when trying to obtain illegal supplies, especially guns and military ordnance. The Warlords will deal with anybody for the right price; sometimes the Nocturnes have hired a local Warlord gang to provide extra muscle. A few of the more honorable Warlords have formed loose alliances and friendships with local the Nocturne groups.

The Seekers: The Seekers are the only group that has as much occult knowledge as the Nocturnes. On several occasions, explorers from both groups have been sent after the same ancient artifact or rare book; such races have sometimes become violent. The Seekers believe that the Nocturnes may be the pawns of a vampire intelligence, so their dealings with that group are cautious at best.

The Lightbringers: “Night and light don’t mix” is the conventional wisdom among the Nocturnes. The Guardians seem to be tailor-made for destroying vampires, so the leaders of the Nocturnes are understandably reluctant to deal with them. Contact between those two groups is minimal at best.

The Spook Squad: The Nocturnes had run afoul of the Paranormal Activities Bureau long before Dark Day. Since many members of that agency now belong to Spook Squad, relations between the two organizations are not cordial.

The Underground Railroad

This is the oldest Nightbane organization known to exist. It has had many names over the centuries; the Underground Railroad was adopted during the 19th century, inspired by the network that helped escaped slaves in pre-Civil War U.S.A. Like that organization, the Nightbane version offers protection and shelter to their kind, while teaching them about their nature, talents, and how to survive (hide from) humankind. To this purpose, the group developed a network of safe-houses, sanctuaries and retreats where Nightbane refugees could be given aid. Some sanctuaries have been built on small islands around the world to provide isolated places where the Nightbane can live in peace. Some exist in remote areas of the Nightlands, where not even the Nightlords have been able to find them.

Dark Day shook up the group. The majority (about 68%) wished to continue leading quiet lives away from humankind. They pointed out that more than ever, newly awakened Nightbane needed guidance and safe places to learn about themselves and how to survive in a dangerous world. However, a growing minority (32%) felt the time for a quiet existence had come to an end. War had been declared, and they were being called to the front lines. Those who wanted to actively fight the Nightlords split up and formed the Resistance (described previously in this section). In the months (and years) to follow, even the Underground Railroad found itself forced to take action against the murderous Nightlords and their minions. With increasing frequency, rescuing a young Nightbane meant a bloody confrontation with the monsters of the Night. As a result, the Searcher Teams in charge of locating and recruiting new Nightbane (and hiding or rescuing Nightbane being hunted by the dark forces) have become experienced fighters. Yet despite the escalation of violence, the members of this Faction continue to believe that it is best to lurk in the shadows, waiting to offer a helping hand and a safe haven, than fight in an open and bloody war.

Campaign and Role-playing Notes

The Underground Railroad is likely to be the first Nightbane Faction the player characters would encounter in the course of a campaign. At first, the young Nightbane will be grateful to their rescuers, and glad to learn some answers about their origins and natures. Later on, however, they may decide that the Railroad is too cautious and even cowardly. This sentiment may entice them to leave the group and to operate on their own or to



join one of the other Factions. The Underground Railroad works well for a “reluctant heroes” campaign. In this case, most or all the player characters simply wish to be left alone, just like most of the members of the Underground Railroad. Regrettably, the world keeps throwing dangers and challenges their way, forcing them to take action despite themselves.

Relations with the Other Factions

The Resistance: In the opinion of many Underground Railroad members, these headstrong would-be saviors are endangering all Nightbane. The U.R. believes they are fighting against hopeless odds, and turning the wrath of the Nightlords against all of them. Furthermore, they fear their actions may one day convince humans of their existence and create more havoc. Still, the two groups grudgingly respects the other’s intentions to help others (despite their methods) and often work together to save Nightbane refugees and freedom fighters.

The Nocturnes: They are viewed with fear and distrust. Members are advised not to communicate with them.

The Warlords: Considered to be a dangerous corrupting influence over Nightbane. Some Searcher Teams have tried to *save* newly recruited Nightbane from life as a Warlord (by means of kidnapping, propaganda, or persuasive argument), which has led to some nasty fights between the two groups.

The Seekers: Since the two groups have little in common, they do not have a lot of contact. Sometimes, however, the Seekers stumble into a Nightbane sanctuary on Earth or the Night-

lands, and the Underground Railroad reacts violently to such intrusions.

The Lightbringers: The strange Guardians are a source of fear and, interestingly enough, hope. The fear comes from the knee-jerk reaction and avoid the unknown. Many members of the Railroad believe that the Lightbringers will defeat the Nightlords on their own, without intervention by the Nightbane.

The Spook Squad: As far as the Underground Railroad is concerned, the Spook Squad is still the enemy, to be avoided if possible, or destroyed otherwise. Most faction members will kill or die before letting a member of the Squad near their sanctuaries and secret hiding places.

The Warlords

In most ways, Nightbane are still basically human. Nothing proves this more than the existence of the Warlords, a Nightbane-dominated street gang that has spread across North America. This faction does not care much about the war with the Nightlords or the presence of vampires or evil supernatural forces. Instead, they are out to defend and control “their” streets against *all* comers. The Warlords have developed a rough code of honor, but they are often involved in the drug trade, protection rackets and other criminal activities. Many are bullies and killers, but there are some who simply don’t know better and even a few true heroes among them.

The first Warlords were Nightbane who had grown up in the violent slums of the United States. Some of them were already gang members when Dark Day and the change came upon them. Using their supernatural powers, they quickly clawed their way to the top of their gangs, and formed a loose alliance of Nightbane ruling over humans. In two or three years, the Warlords had taken over the Bloods, Gangster Disciples, Latin Kings and other nationwide gangs, and absorbed most of the smaller ones. The Warlords have no racial bias: “You’re all red inside,” is the threatening motto of the Warlords’ leaders.

The majority of the Warlords are normal human gang members, cowed into submission by the savage Nightbane leaders and upper echelon. The Nightbane Warlords tend to refer to humans as “meat,” even when talking about (or to) their own gang members. Meat members (humans) can be resentful of their inhuman leaders or too terrified of the Nightbane to do anything but be subservient. However, many are fanatically loyal and respectful of their supernatural leaders and obey them without question.

Stories of ritual torture and cannibalism are common regarding the Warlords. While most of these tales are lies and exaggerations intended to frighten and unnerve the competition, there is more than a grain of truth to them. The Overlord of the gang, *Chow-Down* (see the **Campaign Section** for details) is reputed to be an insane, power-hungry and sadistic monster who has been known to devour his opponents. Many local Warlord gangs have stopped obeying the commands of their national leader in an attempt to maintain a more civilized foundation.

The Warlords go the whole range, from heroic defenders of their turf and homes to violent criminals without scruples. They are the only Nightbane Faction that frequently attacks and kills

other Nightbane and molests innocent humans. The Warlords are still a thorn in the side of the Nightlords, because they reject all authority and violently attack any outsiders or intruders, including minions from the Nightlands. The Nightlords had planned to take over the local gangs, but they are so violently opposed to outsiders that they have rejected even the slightest overtures. Since these Nightbane cannot be subverted or manipulated, the only alternative seems to be complete extermination. For the time being, the Nightlords avoid taking any action against them.

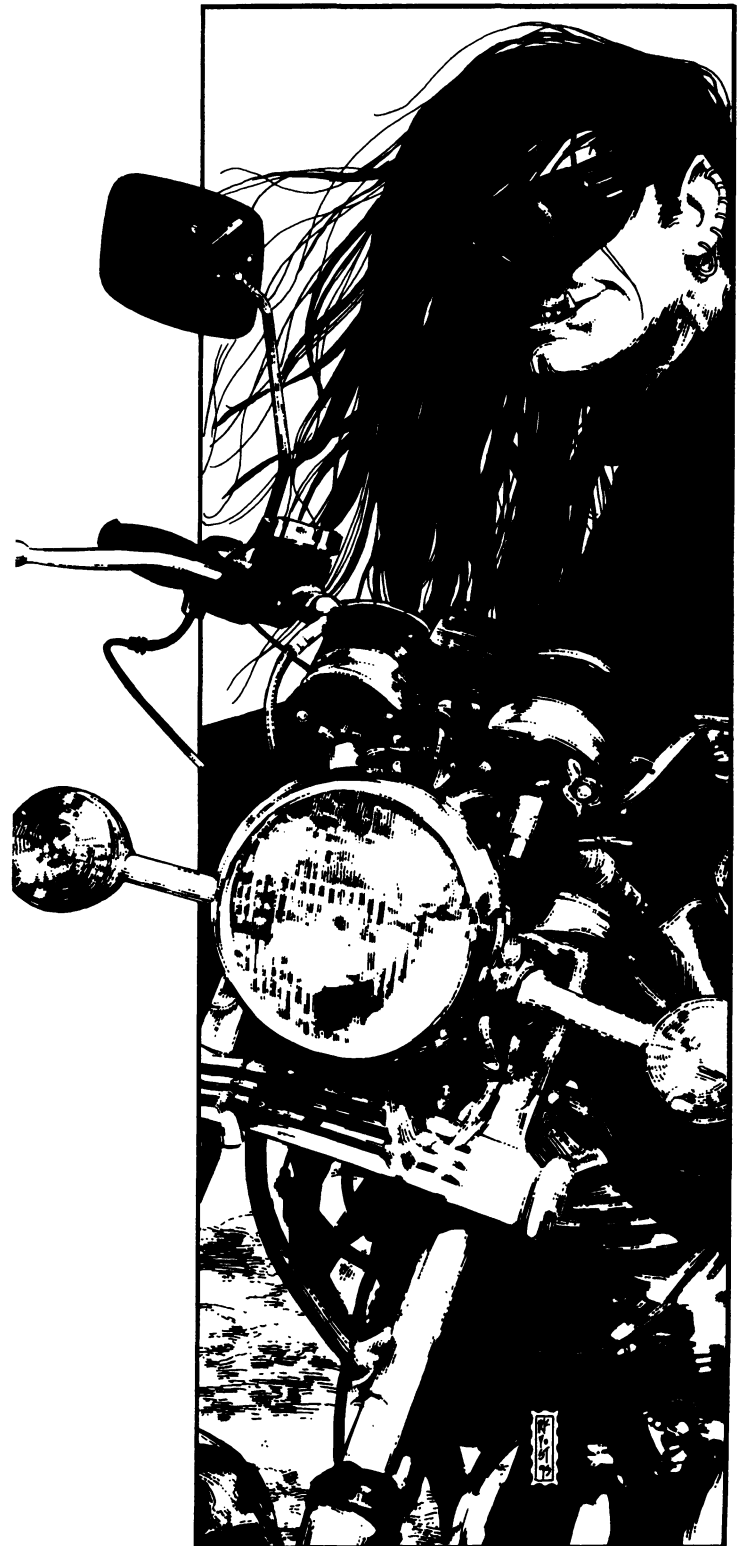

Campaign and Role-playing Notes

The Warlords are more likely to be encountered as hostile non-player characters than as player characters, unless the Game Master wants to run a campaign focusing on crime and violence. It is possible to run a heroic and “good” Warlord-based campaign, but with a great deal of moral dilemmas. Such a campaign could start with the player characters joining the Warlords and then leaving after they become disgusted with their methods. Or some player characters could be Warlord members who are working covertly within other Factions (like the Resistance or the Nocturnes), using their street contacts to fight the Nightlords and to spy on other Factions at the same time. Others could be ex-gang members who are looking to do their part against the Nightlords either by working with other Factions or as independent operators, mercenaries or adventurers.

Relations with the Other Factions

The Resistance: The Resistance is seen as a rival gang, and a state of war exists between the two groups. Nightbane who refuse to join the Warlords are believed to be members of the Resistance and attacked on sight.

The Nocturnes: The Warlords do not like vampires, and hunt them down mercilessly.

The Underground Railroad: The Railroad is treated with hatred and contempt by the Warlords. Often, the gang will try to recruit young Nightbane for themselves and attack any Railroad members who oppose them.

The Seekers, the Lightbringers and Spook Squad: The Warlords have little knowledge of these groups. They are all considered to be part of the Resistance, and treated accordingly, while these groups tend to view the Warlords as dangerous sociopaths and thugs to be avoided.

The Seekers

Human cultures throughout the ages have been fascinated by magic and the occult. By the end of the 20th century, most people thought that magic was mere superstition and fantasy. Unknown to them, sorcerers and arcanists had been practicing the mystic arts in secret. The Seekers are an ancient organization of sorcerers who are becoming active in world affairs for the first time in centuries.

Their membership is predominantly European or North American. For the most part, they began as a group interested in studying magic and learning all they could about strange and unusual things. The organization worked through research foundations, university departments (usually in the fields of archeology, history and literature) and other “respectable” institutions. Members were recruited from people with a talent for magic and those who were interested in studying the supernatural.

They investigate all kinds of supernatural events and creatures, from freak occurrences to bizarre murders and reports of cult activities. Although most of those events turned out to be hoaxes or explainable events, the patient Seekers have learned a great deal about vampires, Nightbane, the Nightlands and the magical arts. In recent years, they have used the Internet and

other computer services to establish a worldwide network of information on strange and unexplained occurrences.

The Seekers were not originally crusaders or would-be heroes. They did not pass judgment on supernatural beings and occurrences. In fact, some Seekers were Nightbane that were rescued by the magicians and inducted into the organization. The sorcerers fought only in self-defense, but when provoked they could be formidable.

Toward the turn of the century, some Seekers started seeing disturbing signs of supernatural activity. Magical places, such as ley lines and ley line nexuses (see the **Magic Section**) began to flare with magical energies. Their computerized search programs started “flagging” an unprecedented number of weird news reports about disappearances, monster sightings, psychic nightmares and other ominous events. A group of Seekers in Salem, Massachusetts wrote a report predicting a major supernatural event sometime in May of 2000, predicting Dark Day almost six months in advance. But other Seeker groups disregarded the evidence. Intervention was not their way. Instead of taking any action, the Seekers continued to watch and wait.

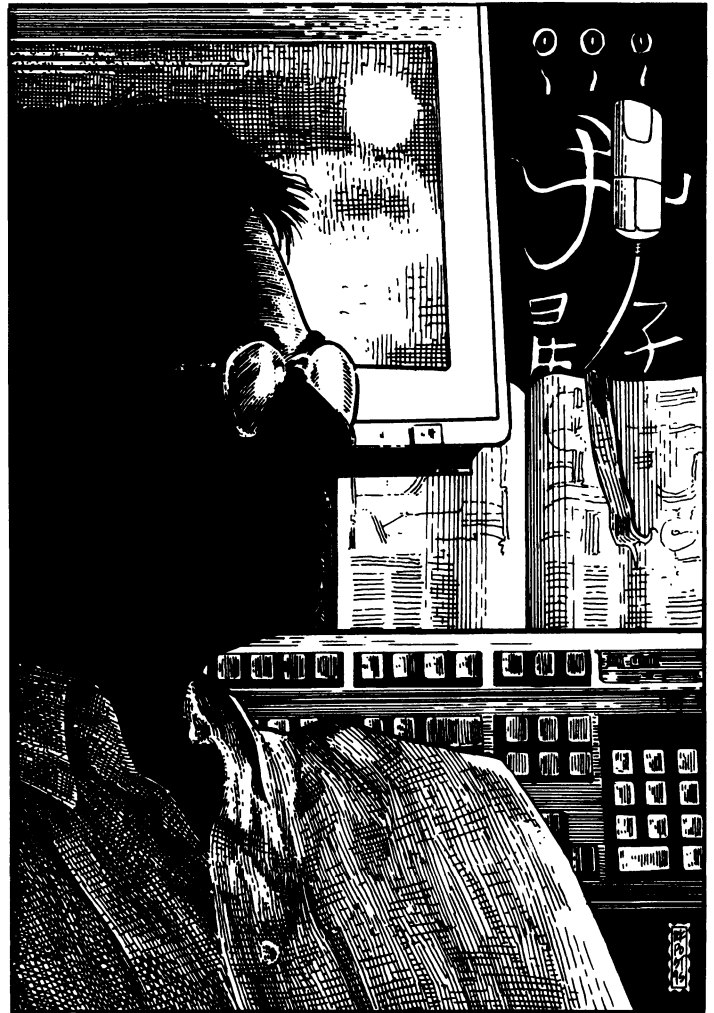

The horrors of Dark Day caught most of the Seekers by surprise. Later, many of them were racked with guilt because of their decision to remain silent and inactive. If only they had taken some sort of action, they might have delayed or even stopped the event. The Nightlords’ steady takeover of the world convinced the group that the time of noninvolvement had come to an end. The Seekers now use their vast knowledge and re-

sources to fight the Nightlords campaign to take over the world. They know as much about the enemy as anybody except the Nightlords themselves and they put that information to good use.

The Seekers rarely attack the Nightlords with guns and bombs. Instead, they use spells to sabotage their plans, or quietly provide information to organizations that will use direct attacks, like the Resistance or the Nocturnes. Their members often go on expeditions into the Nightlands and to remote places on Earth, searching for ancient mystical artifacts (see the **Magic Section**) that can be used against the Nightlords. They are also very efficient in unmasking Doppelgangers and subtly destroying them. The biggest drawback of the group is their impulse to study rather than fight. Although they realize they are in a war, members still want to learn more about the supernatural, and often hesitate when they should act decisively.

Campaign and Role-playing Notes

Above all other things, Seekers love uncovering new secrets. Ancient mysteries, government cover-ups and conspiracies, and anticipating future developments before they completely unfold are all part and parcel of the Seekers' quests. In this organization, magicians, scientists, computer hackers and professional analysts pool their efforts and knowledge to learn new things. Even now, when the world is facing a deadly invasion, the Seekers put knowledge first.

Unlike other groups, Seeker player characters might find themselves traveling to a remote area of the world (the African jungle, perhaps, or the frozen wastes of Antarctica), examining ancient ruins or researching some unusual weather phenomenon. The result of their quest might actually be of more importance than breaking into an Avatar's house with guns blazing, and their mission might be just as dangerous. The Seekers are the group to use if the game master wants to run a game with a great deal of variety, intrigue, subterfuge and travel.

Relations with the Other Factions

The Resistance: The Seekers believe the Resistance is a valuable asset in the war against the Nightlords. Although the Resistance does not trust the humans who run the organization, the feeling is not mutual. Often, information is passed on anonymously to the Resistance, or through Nightbane who are members of both groups. These "double agents" risk expulsion or even death at the hands of the Resistance, despite the fact that they have never done anything to harm either organization. In recent months, the Seekers have been trying to make a formal alliance with the Resistance. Time will tell whether or not they are successful.

The Nocturnes: Many Seekers are not convinced that the Nocturnes are truly independent vampires and supernatural creatures. They fear these characters may be the pawns or even the soldiers of a powerful vampire intelligence, or something even worse. Sorcerers who are member of the Nocturnes have a lot in common with the Seekers and, as a result, informal alliances occur between those individuals more often than the leaders of the Seekers would like to see.

The Underground Railroad: In the past, some Seekers helped the Underground Railroad, but the organization was too paranoid to let human mages become very involved with their secret network. Today, there is very little contact between the two groups.

The Warlords: Considered to be dangerous, unpredictable criminals. Sometimes, the Seekers will try to manipulate a Warlord gang into attacking a target the Seekers cannot destroy directly. This is a very dangerous game, and many Seekers have paid for it with their lives. The Warlords do not like to be manipulated and react violently to any such attempts.

The Lightbringers: The Guardians fascinate the Seekers. They are constantly trying to learn more about them and to make contact with them. The Guardians remain elusive, although the two groups work together more often than anybody else. Some scholars have discovered many ancient stories about the Guardians/Lightbringers, and suspect these beings may be servants of an unknown higher power.

The Spook Squad: To the dismay of many Seekers, a number of human arcanists who belonged to their group have defected and joined the Spook Squad, taking with them a lot of valuable information. Most Seekers distrust government types (even former government types who are now in hiding). They believe the Spook Squad might turn against them and the innocent or well-intentioned Nightbane after the Nightlords are defeated.

The Lightbringers

Ross tried to take the drink offered to him, but found that his hands were still shaking too badly. He leaned back on his chair and continued his story.

"There were six Hounds in the house. They caught Lydia while she was still wearing her Facade. She never had a chance. I managed to change, but six on one — I was a gonner, and I knew it. That's when the strangers came."

"You sure they weren't Nightbane?" Lloyd broke in. "You know, the pretty boy types that we get from time to time."

"No way. I would have sensed them coming. I never got a twitch. Two men and a woman, wearing trenchcoats. All three of them were platinum blondes — they looked almost like albinos. They walked in, and suddenly they started to glow, like they were on fire. It got so it hurt to look at them directly. The Hounds actually hesitated for a couple of seconds, but then four went after the shiny guys, and two stayed to tango with me."

"Four on three," Sergeant muttered, considering the odds. "Not impossible, if the three Nightbane know how to handle themselves."

"I'm telling you, these weren't our kind," Ross snapped. "The Hounds never had a chance. The three strangers just opened up with beams of light, like lasers! Even from where I was, I felt warmth, as if I was outside on a bright summer morning. They burned big smoking holes in the Hounds, and three of 'em went down before they even reached the strangers. The last one got taken out by a couple of fancy kung-fu moves. I managed to take out one of the two Hounds, and the other one ran. First time I ever seen a Hound run from a fight, too."

"Then what?" Lloyd asked. He looked worried.

"Well, one of the two guys looked ready to let me have it. Then the woman said, 'No, Gaius, he's not an enemy,' and they left without saying good-bye or anything. Truth to tell, I was too happy to be alive to really get mad at their manners."

"I've heard of them before," Lloyd said in a low voice. "The Guardians."

"You sure?" Sergeant said. "I thought they were a fairy tale."

"Sure. Like monsters, shape shifters, and people walking through mirrors."

"Fine, you made your point."

The Lightbringers are one of the strangest groups in the Nightlord-ravaged world of **Nightbane**. Their membership includes both Nightbane and humans, but the group is believed to be led by the mysterious Guardians. The Guardians, sometimes called *Lightbringers*, were a legend in the days before Dark Day. Old Nightbane whispered stories about these angel-like beings who would sometimes appear to destroy those who preyed on humans. In recent times, reports of Guardian sightings have multiplied a thousandfold. The mysterious beings are appearing in ever greater numbers, attacking the minions of the Nightlords, the growing vampire population, and those Nightbane who try to abuse their powers. Even more interestingly, the Guardians seem to be behind a *Faction* called the **Lightbringers**.

The rumors about the Lightbringers are true. This small Faction operates around the world, and the Guardians are firmly in control of it. Humans and Nightbane have been recruited into their ranks, where the three racial groups all work together. According to some occultists, most Guardians were normal humans who were somehow changed by an unknown power — maybe by magic, the Supreme Deity, or the life force of the planet. Nobody, not even the Guardians, seems to know with certainty. According to some Guardians, they were transformed after enduring a near-death experience; they conversed with a light at the end of a tunnel, and were offered a second chance at life with a new mission. In ancient times, the Guardians may have been mistaken for angels or divine beings. A few theorize that the Guardians come from the **Lightlands**, a mythical paradise that is the direct opposite of the Nightlands. If so, the coming of Dark Day might have triggered the "activation" of many more Guardians than ever existed before.

Besides the Guardians, the Lightbringers have many humans among their members. Priests, religious people, mystics, normal folks and even Nightbane have chosen to follow them. They have formed their own "underground railroad," protecting dissidents, helping political prisoners escape, and even physically or mystically attacking the Nightlords' minions. A lot of the guidance for the organization and affiliate branches comes from "visions" and premonitions experienced by the Guardians and a handful of their human and Nightbane allies. Occasionally, strange lights can be seen in the sky over remote farmlands where many Lightbringers settle. UFO sightings seem a lot more frequent near these locations too. A few of the human and Nightbane Lightbringers suspect that the Guardians are actually extraterrestrials!

The Lightbringers are organized in small groups. Most of them are scattered in the Midwest and Northwest in the United States of America, and in lightly populated areas throughout the world (coincidentally, many of those areas have a long history of UFO activity). Some bands of Lightbringers operate in large cities, working directly against the Nightlords.

Campaign and Role-playing Notes

The central theme revolving around the Lightbringers is mystery. Nobody, not even the Lightbringers themselves, truly know who or what is behind the Guardians, or why. Lightbringer player characters may be the pawns of an alien force with unimaginable purposes, or they may actually be saviors of the world, guided and empowered by the Forces of Light. Many Lightbringers believe they are the warriors of God, and have a highly religious and/or mystical attitude. This often makes them self-righteous and quick to persecute non-believers or "demons," including Nightbane! A few are fanatics who believe the Apocalypse is at hand and who have little concern for their own lives

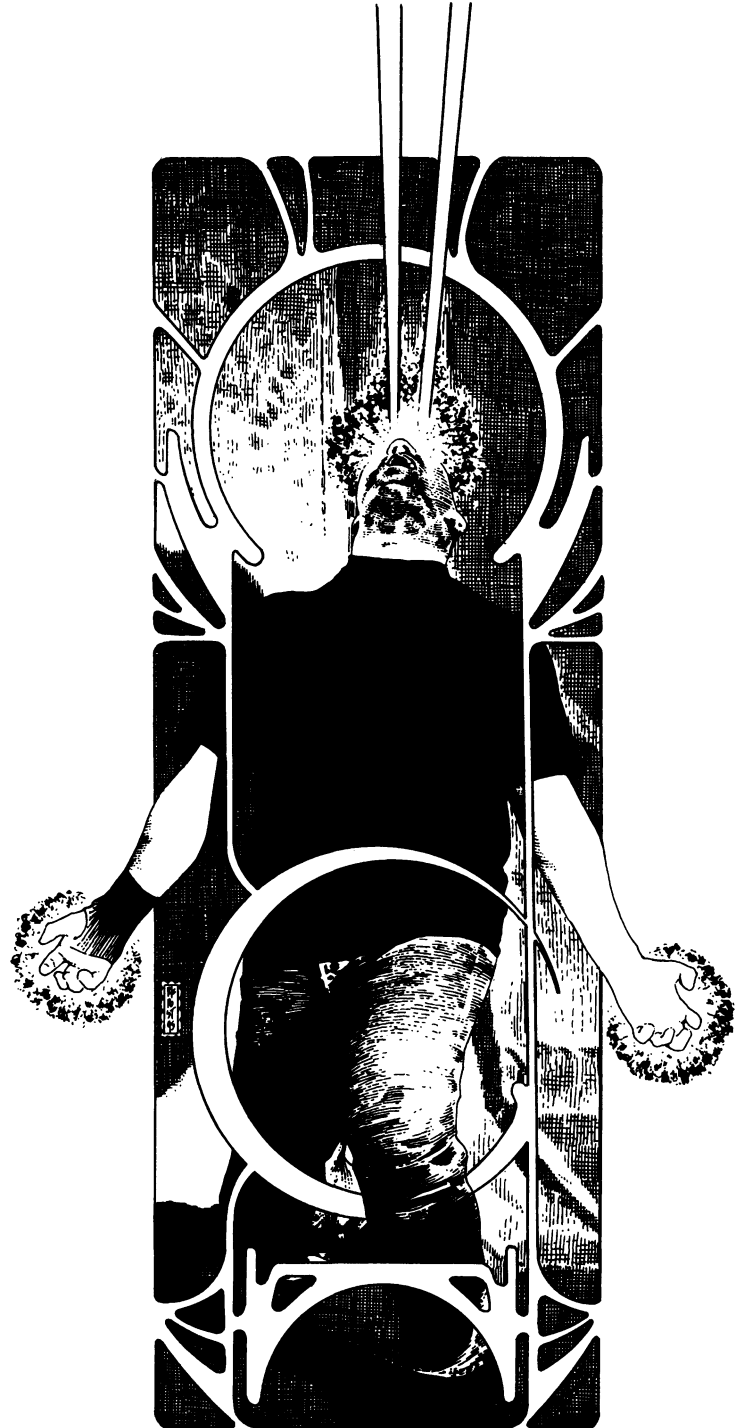

— or those of others. Others are generous, selfless crusaders who accept one and all in the service of their cause and exhibit great patience and compassion.

Relations with the Other Factions

Many Lightbringers come into contact with other groups and organizations, often by helping them unexpectedly. Some groups are more willing to accept their charity than others, however.

The Resistance: Although the Resistance, by and large, distrusts the Lightbringers, these creatures of light have had visions that seems to point to them as the key to destroying the Nightlords and saving the Earth. As a result, most Lightbringers feel honor-bound to help the Resistance in every possible way.

The more fanatical members of the Lightbringers consider all Nightbane to be hell-bound monsters, and either refuse to help them or actively attack or obstruct them on sight; this hasn't helped the tentative relationship between the two.

The Nocturnes: In this case, the distrust is mutual. Vampires are perceived as a mortal threat, and all undead are considered to be damned souls that must be destroyed. In most cases, hearing that a group of vampires is operating in their area (whether or not they are associated with the Nocturnes) means that the Lightbringers will stop their war against the Nightlords and pull out their stakes and holy water — vampires are their sworn enemy.

The Underground Railroad: Since many of the Lightbringers are dedicated to helping hide victims of persecution, the two groups often cross paths. Some Lightbringers actually live right next to U.R. Sanctuaries! In most cases, the Lightbringers have established an uneasy truce with the Nightbane communities. On several occasions, former Underground Railroad members have actually joined their Lightbringer neighbors, converted by the apparent saintliness and dedication of their membership.

The Warlords: The Nightbane street gang is at best an annoyance and at worst, a threat to everything the Lightbringers work for. Many of the “anti-Nightbane” religious members see the Warlords’ crimes as proof that all Nightbane are damned and should be destroyed. Fortunately, most Guardians do not share these prejudices, but they do not cut the Warlords any slack; more than once, cocky “gangsta-Nightbane” have gotten themselves killed by picking a fight with the strange white-haired “choir boys.”

The Seekers: The two groups often work together, although their philosophies always clash. The Seekers want knowledge and information before they make any decisions. They hate to work in the dark and reject the notion of “blind” faith. The Lightbringers, on the other hand, are guided by faith rather than reason. Their visions and intuition are all they need. The Seekers’ constant inquisitiveness often annoys the Lightbringers, especially because they do not have any rational answers to offer. At the same time, the Seekers suspect that what the Lightbringers don't know may actually be a horrible and dangerous secret. Only time will tell.

The Spook Squad: This ex-government agency has very little faith in “angels” or glowing heroes. With the exception of a few religious zealots, most “spooks” believe the Guardians are aliens with dubious intentions, and their human followers are dupes and pawns. However, as long as a Spook Squad doesn't attack the Lightbringers, the Lightbringers leave them alone. Since the common enemy facing both groups is powerful and dangerous,

the two organizations have better things to do than to face off against one another.

The Spook Squad

“I never thought I'd live to see this. Here they were, the former deputy director of the CIA, the commander of the FBI's Hostage Rescue Team, a three-star general, a local precinct captain, a young woman in black who introduced herself as “a practicing witch” and Professor Steuben, the wacko author of Monsters Among Us, all sitting together and talking business in an abandoned warehouse on Chicago's bad part of town. And the best part of it was, what they were discussing would determine where my strike team would plant the bombs. Welcome to the Twilight Zone.”

—Lieutenant Arthur Doolittle, former Navy SEAL

The Spook Squad is the one group where Nightbane and supernatural beings (including magicians, arcanists and wizards) are in the distinct minority. In this case, the “spooks” refer to members of “special” agencies like the CIA, the NSA, the Secret Service, and the PAB, the very secret *Paranormal Activities Bureau*. These “spooks” have been forced underground by the machinations of the Nightlords, and are now fighting against them. These former spies, law enforcement agents, and soldiers know that alien beings have taken over the United States and other global governments. They know little about the Nightlands or exactly what the “aliens” are (many think they are extraterrestrial beings from another planet), which sometimes handicaps their efforts. Still, they are very well trained, equipped, experienced and dedicated.

The core of Spook Squad is the Paranormal Activities Bureau (PAB). It was founded in the early fifties, when the UFO scares and reports that the Soviet Union was conducting psychic research prompted a number of “Cold Warrior” politicians to push for the funding of a special agency dedicated to dealing with unusual events. The PAB also led programs designed to create “countermeasures” against the use of psychic powers and paranormal phenomena. This secret agency never had an official charter or funding; money was funneled to it through fake “agricultural subsidies” and other covert means. The PAB has diminished in size and importance by the 21st Century, even though it *had* made some important strides in the investigation of psychic powers and had managed to hunt down and capture several dozen supernatural beings.

Following Dark Day, the PAB was attacked by Hounds and other minions of Night. Many research centers were destroyed, but, surprisingly, the government agents managed to survive most attacks, and went underground. When the new tool of the Nightlords, the National Security Bureau (NSB), absorbed all other agencies and started to persecute former federal agents, these “Feds” also went underground, linking with the PAB and forming what is now known as Spook Squad.

Only a handful of Nightbane have joined this organization, largely because most members are prejudiced against supernatural beings. Although the human agents recognize the fact that some Nightbane are on their side, they prefer to keep them at arm's length. There are some camps in Spook Squad that think

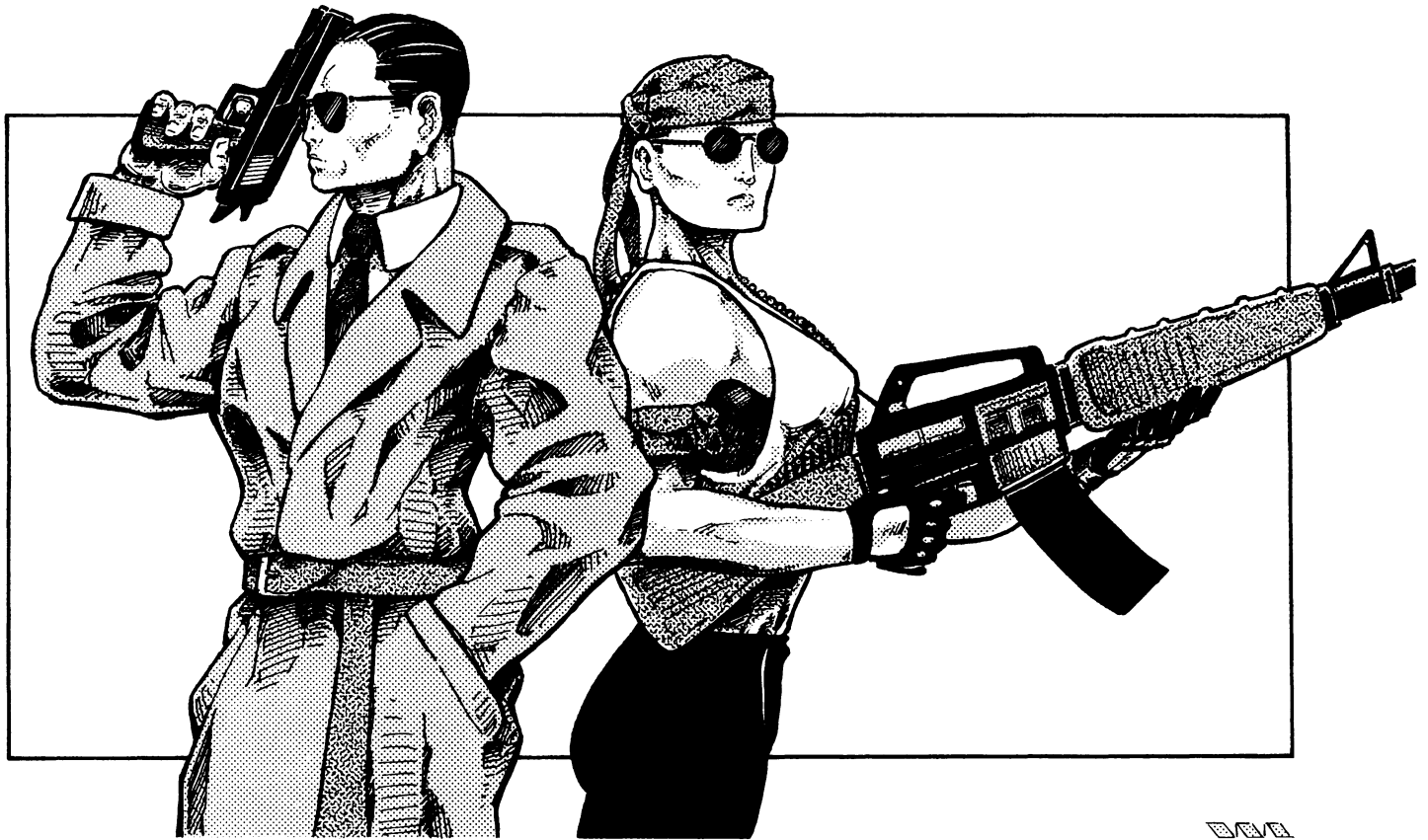

that all Nightbane, including those who work for them, should be destroyed. This makes life in the Squad difficult for Nightbane who join their ranks — they are not trusted and an accusing finger is pointed at them the moment something goes awry.

No vampires or other supernatural creatures have been recruited, but a handful of lesser magicians and psychics work with the group. The best agents the Squad has against the Nightlords are psychics who were “created” in a number of secret labs in the Mid-West. When the Nightlords took over, many of the labs’ staffs and the young psychics managed to escape and made contact with Spook Squad.

Note: This group will be fully developed in the *upcoming Nightbane supplement, Spook Squad*, detailing new O.C.C.s, Psychic Character Classes, background information, methods and special equipment. In the meanwhile, characters found in **Beyond the Supernatural** can be easily incorporated.

Relations with the Other Factions

Spook Squad is in some ways the most intolerant faction involved in the war against the Nightlords. In the eyes of its leaders (and many of its members), all supernatural beings are to be considered enemies until proven otherwise, and even then viewed with extreme prejudice and distrust. Many of the ex-government types that form this organization belonged to agencies that had been secretly hunting down, destroying or imprisoning supernatural beings for years. This hasn’t made forming alliances any easier.

The Resistance: Although the methods and targets of both factions have a lot in common, any organization controlled or dominated by “alien monsters” (as they regard the Nightbane) is not a group the Squad is going to want to deal with. Often, the

two groups end up stumbling into each other, usually when they are going after the same targets. These encounters have a fifty-fifty chance of turning into a temporary alliance or degenerating into a three-way firefight between the Squad, the Nightbane, and the Nightlords’ minions!

The Nocturnes: If anything, this group is considered to be less trustworthy than the Resistance. At least the Nightbane are monsters who may still have strong ties to humankind; vampires and their ilk are supernatural predators — the only sensible thing to do is to destroy them.

The Underground Railroad: Only a tiny handful of Spook Squad members know anything about the U.R., the vast majority are completely unaware of the ancient network. If this organization and its history were revealed, paranoia about an ancient “Nightbane Conspiracy” would go rampant, possibly even leading to a purge of all Nightbane currently working within the Squad! For this reason, the few agents and analysts who know (or suspect) of the existence of the Underground Railroad keep this fact a secret.

The Warlords: Frequently touted as “proof” that supernatural beings are a threat to humankind, the Warlords are often targeted for “termination” whenever a more important target cannot be found.

The Seekers: Many Spook Squad agents contemptuously refer to the Seekers as “the Bookworms.” They consider these psychic investigators and mages to be pretentious intellectuals living in an “ivory tower,” and too busy trying to learn forbidden secrets to take care of the important things, including the war against the Nightlords. Even former Seekers who have joined the Squad have not escaped this stigma.

The Lightbringers: The current “pet theory” among Squad members is that the Lightbringers are agents of extraterrestrials and were probably involved in abductions and cattle mutilations before attacking the Nightlords. So far, no Guardian has been captured alive by the Squad, but the group’s scientists are itching for a chance to get their hands (and scalpels) on one of those strange creatures.

The Others

Besides the Ba’al and the Nightbane, other supernatural creatures live on Earth, and, like humans, have been affected by the invasion. The supernatural beings of the world are, if anything, at greater risk than normal humans because the Nightlords make it a point to destroy or enslave them. The Ba’al don’t want any “competition,” and such beings as vampires and sorcerers represent a threat that must be dealt with before humankind can be fully conquered.

Vampires

Some of the legends of vampires and werewolves were started by criminal or insane Nightbane who acted like the monsters they resembled. Some, but not all. Even before Dark Day, creatures of the night hunted unsuspecting humans. Vampires have walked the Earth for millennia, unsuspected and unopposed, feeding off the poor, the defenseless, and the careless. By the time of Dark Day, thousands of vampires existed, hiding among the teeming masses of modern cities.

Vampires have no links to the Nightlands or their inhabitants. They are beings from another plane of reality, and are the creations of the dreaded vampire intelligences, totally alien monsters who live only to feed and grow in power. A few vampires break free from their creators, changing into a different species (see the **Wampyr R.C.C.** for more information), but most are near-mindless slaves of their hungers and their supernatural masters. Over the centuries, several vampire intelligences have tried to turn Earth into their feeding ground, only to be thwarted time and time again by human priests, mystics and warriors. While the vampire threat has never been eradicated, it has not become a worldwide threat.

Since the dawn of civilization, some vampire intelligences and master vampires had been aware of the Nightlands (see the **Vampire Threat Section** for more information about vampire types and their powers). Some vampires dwell in the Nightlands, hunting and enjoying a land where the sun never rises. For the most part, the Nightlords were too dangerous an enemy, so the vampires have been content with their hunting grounds on Earth.

Then the Ba’al invaded. Somehow, the Nightlords had learned of the location of many vampire hiding places. During Dark Day, their minions hunted vampires, killing hundreds of them. It is rumored that one vampire intelligence was destroyed in the attack along with all of its creations. In a sense, the Nightlords’ attack cleansed much of the world of an evil scourge — although it soon replaced it with an even worse one.

However, despite their best efforts, the vampires were not eradicated from the face of the planet. In the sewers and slums of great cities, and in remote towns and villages far removed

from the Nightlords’ city-states, the vampires regrouped and recruited new members. Whenever possible, vampires will kill any and all minions of the Nightlords, a hostility that is fully reciprocated. At the same time, vampires are also enemies of the Nightbane, who often interfere with their hunting and feeding. Only renegade vampires, such as those who associate with the Nocturnes, have been able to make lasting alliances with some Nightbane.

Sorcerous Orders

Although magic has been all but forgotten and discarded in the minds of modern people, its secrets have been hoarded and passed on for generations. Small groups of gifted humans have learned that spells do work and that miraculous things are possible with the proper training and willpower. Most of these magicians lived quiet, often lonely lives, removed from the common troubles of humankind. A few used their powers to achieve fame and fortune by means fair or foul. An even smaller number acted as secret protectors of the world, helping psychic investigators and other unsung (and often reviled) heroes in destroying vampires and other supernatural threats.

A large number of so-called sorcerers were actually slaves or “priests” of the Nightlords. The Ba’al have the power to sense when humans peering through the Mirrorwall do not take the proper precautions. More than one would-be magician stumbled into the Nightlands, to be murdered or enslaved. The Ba’al-Zebul, the Night Princes, walked the Earth, tempting promising magicians with enormous power in return for services to be rendered. These corrupted magicians formed the **Cults of Eternal Night**, a secret and widespread society that was dedicated to bringing the Ba’al’s rule to Earth. It is unknown how much the Cultists of Night had to do with Dark Day, but it is clear that they had played a role in it.

Besides the Cults of Night, there were few other, truly organized groups of sorcerers. Most so-called “Orders” did not number more than a dozen or so members, and they tended to be localized to one country, state or even a single city. In centuries past, some ambitious magicians had tried to create a worldwide network of arcanists, with the goal of helping, or even conquering, the planet. All such attempts failed, often through the efforts of other sorcerers. The largest groups to include sorcerers were the Nocturnes and the Seekers, neither of which was controlled by dark forces.

These men (and women) of magic sensed many clues pointing to the invasion of Earth. Many groups of sorcerers were aware of strange portents, a flaring of ley line energy, the appearance of supernatural doubles (the Doppelgangers), and other strange and unusual events. The lack of a unified organization meant that those who knew or suspected the truth could do little about it, other than to warn their friends, relatives and magicians of their acquaintance. A few even tried to warn the public, but their words never saw the light; the Nightlord minions who had already infiltrated the media had an easy time squelching the “lunatic ravings” of those brave sorcerers. After Dark Day, every mystic who publicly spoke about the threat was hunted down; most of them were killed.

Of the rest, about half of all Earth’s sorcerers are still alone or grouped in small bands of less than a dozen members. The remainder have joined one of the larger factions, especially the

Nocturnes, the Seekers, and Spook Squad (although a growing number have also become Lightbringers, especially those magicians with mystic or religious leanings). Rituals that gave access to the Nightlands have become widespread as those few who knew them teach them to everyone they can. This knowledge has become very important in the efforts to take the war to the homeland of the Nightlords.

The Guardians

“Every time I go to sleep, I’m afraid.

“You see, once before, I had a normal life when I went to sleep. At least, I think I did. I can’t quite remember, although once in a while I get these flashbacks. I think I was married and had two kids. A boy and a girl. I think I might have been happy, but I can’t be sure. Some of the flashbacks aren’t all that pleasant.

“One day, I woke up behind a dumpster, in an alley. I saw my face reflected in a pool of water, only it wasn’t my face anymore. I can’t remember what my old face looked like, but this wasn’t it. The hair was all white and my eyes were almost transparent-blue. My skin was sheet-white. And I was short, almost the size of a child. And, although my memories were gone, I remembered that I had seen a light, and it had spoken to me. I was a Guardian, the voice said, and I had a task to complete. For some reason, although it made no sense at all, the memory and the mission, felt right.

“I met other Guardians later on. They all looked like my brothers and sisters. One of them was an Elder Guardian, and he knew a lot more than any of us, but he doesn’t tell us much. We all suspect we were regular people once, until we got ‘recruited.’ Some of us think we died and we have been brought back from Heaven as avenging angels. Others laugh at that conceit and think we were abducted by aliens and remade in their image. I’ve stopped caring about what we are. What we do is more important. We have fought monsters I never suspected existed; vampires, shape shifters and insane cultists, and worse. We’ve also helped people, sometimes in completely unexpected ways. Sometimes, helping a man to stay dry and sober, not to fall off the wagon, feels as important as destroying a nest of demons. We’ve done a lot of good, my fellow Guardians and I.

“But I’m still afraid every time I go to sleep. Afraid I’m going to wake up, and that all this will be a dream. I think I want to return to my normal life, but I’m afraid of doing so.

“The world needs us too much.”

Even before Dark Day, thousands of people had disappeared without trace. Most of those disappearances have natural causes; spouses abandoning their families to start over, people with bad debts running away, or victims of accidents, crime and other misfortunes. A few, however, disappeared one day and came back as Guardians.

The Guardians are supernatural beings with white hair and skin, with light, semi-transparent eyes. Their features can be European, Asiatic or African, but their skin color remains an albino white. They have great powers over light and light energies, as well as possessing a number of psychic abilities. They can



heal the sick and see into the hearts of people — they all feel a profound need to help and protect humankind. Most have only dim recollections of their previous lives, and remember little about their transformation. They could be angels, aliens, or neither. They are certainly the agents of a powerful being with seemingly benign purposes.

Before Dark Day, there were only a handful of Guardians in the entire world. Some Nightbane old enough to know, claim they may have seen the Guardians in ancient times, and that these enigmatic beings gave rise to many tales of angels, good spirits, and Faerie Lords. On the other hand, the creatures responsible for such myths could have well been Nightbane, so it is not clear. After the invasion began, the Guardians started to appear in great numbers. A great many “elder” Guardians (who claimed to have lived long before Dark Day) have also made their appearance. These Elders guided the new Guardians, teaching them about their powers and duties. They are very close-lipped about their origin, but a few slips refer to their coming from “Outside” or “Beyond.” Even these clues are ambiguous, leaving people to decide as to whether the Guardians come from beyond our planet, or perhaps beyond the mundane world.

Most Guardians are associated with the **Lightbringers**, a Faction of Nightbane, humans and mages dedicated to the destruction of the Nightlords. However, there are scores of smaller independent groups and teams who wage their own war against the dark forces that enslave the people of Earth. Recently, some of the new Guardians are reborn without any memories of their

past and no sense of their purpose. They continue to help humankind, as if by instinct, but on their own, in pairs, or in small groups. What this means exactly is unknown, but then virtually everything about the Guardian race is a mystery.

The Nightbane Lexicon

Listed below are some of the concepts, nicknames and words used by Nightbane “society,” mages, occultists and some denizens of the Nightlands.

Ancients: Nightbane who have lived over 200 years. Most Ancients are extremely powerful.

Artifacts: Ancient magical items and weapons, sometimes found in old ruins in the Waste or in the keeping of the Nightlords. Artifacts are indestructible and eternal. Many of them have the power to slay the Nightlords.

Ashmedai (a.k.a. The Crawling Horrors): Grotesque servants of the Nightlords able to metamorphosize at will into human forms, but whose true shape is that of a giant worm-like thing with multiple tentacles.

Avatars: Independent creations of the Nightlords who fully share their creators’ memories and personalities, but who (thankfully) have only a fraction of their power. Avatars are used as war leaders, agents and lesser rulers. Destroying an Avatar harms the Nightlord who created it. Some Avatars learn to cherish their individuality and turn against their creators.

Ba’al: An older term for the Nightlords, a form of the ancient Canaanite word for “lord or master.” The complete term is *Ba’al-ze-neckt* (Lord of Night), but the term is archaic and rarely used (see Nightlord).

Ba’al-Zebul: Literally, “princes and lords,” old title of the Night Princes, and also the name from which the word *Beelzebub* (“Lord of the Flies”) comes from (also see Night Prince).

Becoming, The: Term for the time when a Nightbane’s powers manifest for the first time. Before the Becoming, the Nightbane appears to be a completely normal human. The Becoming usually occurs sometime between the teens and early twenties of the Nightbane, although older and younger cases are not unknown. This often shocking time typically occurs for no apparent reason, often while the Nightbane sleeps, although it may coincide with a traumatic event such as an accident, fight, etc.

Barbi (or Ken): Derogatory nickname given to Nightbane whose Morphuses do not have any major or noticeable deformity.

Beasty Boys/Girls: Nickname given to Nightbane whose Morphus have animal features.

Borg Boys/Girls: Nickname given to Nightbane with a biomechanical Morphus; appears to be a living machine or part machine, part living creature.

Choir Boys/Girls: Contemptuous nickname for the Guardians; also used to insult religious Nightbane and humans, particularly members of the Lightbringer Faction.

Dark Day: Common term for a freak event during which the skies were inexplicably darkened for twenty-four hours. The sudden darkness and the lack of rational explanations caused

panicked outbreaks that led to riots, mass suicides and near anarchy around the world. It is believed by occultists to have been the work of the Nightlords.

Doppelgangers: The most common inhabitants of the Nightlands. Doppelgangers are almost exact replicas of people living on Earth. They seem to know almost everything their Earth counterparts know, but are in a daze for the most part, unless they are somehow awakened. “Awakened” Doppelgangers often try to use magic to cross over to Earth and kill and replace their human counterpart. The Nightlords use Doppelgangers as slaves and agents.

Facade: The human form of a Nightbane. There is some doubt as to whether the Facade is actually the true shape of the Nightbane. If killed while “wearing” the Facade, the Nightbane body will decompose like a normal human body.

Factions: Large groups of Nightbane and/or humans and others who gather together with the purpose of helping Nightbane and/or destroying the Nightlords. The largest known factions are: **The Resistance**, dominated by Nightbane and dedicated to fighting the Nightlords on Earth; **the Underground Railroad**, the oldest Nightbane group, whose aim is to hide and protect Nightbane from the world at large; **the Nocturnes**, a group controlled by Wampyrs (see *Vampire Threat Section*) whose goal is the destruction of both the Nightlords and Vampire Intelligences; **the Seekers**, a society of sorcerers now pledged to defend the world; **the Lightbringers**, controlled by the mysterious Guardians; and **Spook Squad**, a human organization encompassing several former members of security and spy agencies.

Formless Ones, The: According to ancient myths and legends, the Formless Ones were the original inhabitants of the Nightlands, but were deceived and then exterminated by the Nightlords. The Formless Ones were beings of pure mental energy who could assume any form they wished. Some scholars claim the Formless Ones fled to Earth — and that they are the Nightbane. Dissenters believe the Formless Ones somehow bred or mingled with humans for the same result. Many more think they perished long ago or never existed at all.

Freak Show: A common term used to describe Nightbane with a severely deformed, monstrous Morphus, especially those afflicted with Stigmata (see the Creating the Nightbane Section).

Guardians: Strange creatures with white hair and eyes, with powers over light and sunlight. Some Guardians appear to be normal men and women who one day find themselves with vague memories of their past and having new powers and appearance. Most Guardians seem to work for the secret society known as the *Lightbringers*.

Hollow Men (a.k.a. the Namtar, “the Men In Black”): Humanoid constructs created by the Namtar race. The Namtar are tiny beetle-like monsters who create ambulatory shells they inhabit and use as vehicles. Many Hollow Men work for the National Security Bureau (NSB). The typical Hollow Men shows no emotion and acts like a flesh-and-bone robot. These “Men In Black” dress conservatively and wear dark glasses. The name comes from UFO “mythology” about the impassive government agents who supposedly squash rumors about paranormal activity and space aliens. The Namtar can make all types of constructs, but prefer human or humanoid shapes above all others.

Hounds: Servants of the Nightlords that look like metallic-black skeletal warriors, armed with primitive weapons. The Hounds are merciless, sadistic hunters able to follow the tracks of supernatural beings.

Hunters: Minions of the Nightlords, these creatures appear like skeletal vulture-men, with a shiny black exoskeleton. Hunters are used as scouts, messengers and assassins.

Latent: A Nightbane whose powers have not yet manifested. Before Dark Day, latents had a good chance of living out normal lives without ever transforming. Now, most latents manifest their superhuman nature before their twenty-fifth birthday. Latents have no Nightbane powers before they experience the Becoming, but their Nightbane essence can be discerned by the See Truth talent possessed by some Nightbane (also see, the Becoming and Nightbane).

Lightbringers: A secret group that has operated on Earth for centuries, fighting vampires and supernatural creatures. Controlled for the most part by the mysterious Guardians.

Mirrorwall, the: A term given to the separation between the Nightlands and the “real” world. The term comes from the Nightbane ability to cross over from one place to the other by walking (or pouring themselves) through any mirror or hard, reflective surface.

Morphus: The monstrous or inhuman form of the Nightbane. Some believe the Morphus is the living embodiment of the Nightbane’s soul. If killed while wearing the Morphus, the Nightbane’s body dissolves into a pool of black light and “evaporates” much like a mirage on a road. Also referred to as the True Form. The plural form is either Morphi or Morphus (the first form is most commonly used by older Nightbane).

Namtar: An insectoid race able to create magical constructs that look like living human beings (see *Hollow People*).

Nightlands, The: A parallel dimension or world that seems to coexist right next to Earth. It is separated only by a flimsy dimensional barrier commonly known as the Mirrorwall. The Nightlands have no visible sun or stars, and are always engulfed by darkness. Most cities on Earth have correspondent equivalents in the Nightlands, leading some occultists to propose that the Nightlands are some horrific reflection of Earth’s fears and desires.

Nightlords (a.k.a.. The Lords, Lords of Night, and The Ba’al): Powerful supernatural beings who rule the cities in the Nightlands and have orchestrated the invasion of Earth. The Nightlords have great powers over matter and energy, and are nearly invulnerable to conventional weapons. In addition to their minions, they can create lesser versions of themselves to send out as their agents (see *Avatars*). Some legends claim the Nightlord were once powerful human sorcerers who were expelled from Earth for worshipping evil entities. The Ba’al orchestrated and led the invasion of Earth that started with Dark Day.

Nightbane: A mysterious race of shape-shifters, each of which has a different alien, inhuman form (see *Morphus*) and a human form (see *Facade*). While in the Morphus shape, the character possesses a number of supernatural powers (see *Talents*). It is believed that the Nightbane are refugees from the Nightlands that took human form or mixed their essence with that of normal humans. Most Nightbane are currently fighting the Nightlords and their minions.

Night Princes (a.k.a. Baal-Zebul): These servants of the Nightlords are lesser specimens of the Ba’al race (see *Ba’al and Nightlords*). They have great powers of illusion and magic, and have visited earth in the past, possibly giving origin to the leg-ends of demons.

Sorcerer: A human or Nightbane practitioner of magic. Very few sorcerers existed on Earth at the time of Dark Day, but many have acquired new pupils to help fight the invasion of Earth since then.

Talents: Supernatural powers usable only by Nightbane, powered by potential psychic energy (P.P.E.). Dozens of Talents have been recorded while being used by different Nightbane. Among them are the ability to manipulate dark energy in the form of weapons, attacks and defenses, the power to alter their shapes, and the ability to pierce through magical disguises and to protect themselves from magical and psionic attacks.

True Form: See Morphus, above.

Vampires: The blood-sucking creatures of legend. Vampires are the creation of Vampire Intelligences. Most lost their free will and much of their personality, becoming slaves to their inhuman hungers and the mental control of the Master Vampire and the Vampire Intelligence.

Vampire Intelligences: Monstrous beings from another reality who create vampires to extend their power and influence. These creatures look like tentacled mounds of flesh built around a single giant eye. It is believed that two or three of these monsters exist on Earth. The Nightlords and Vampire Intelligences are mortal enemies.

Wampyr (pronounce Vom-peer): Originally, just another term for Vampire. Among supernatural creatures, the term applied to an independent vampire, one who is no longer controlled by the alien intelligence that created it. Wampyrs lose some of their vampiric powers as well as their vulnerabilities, but can gain a number of magical and psionic abilities. These creatures can be good or evil, and some work alongside Nightbane and humans (see the Wampyr R.C.C. elsewhere in this book).

Waste, The: The desert-like lands surrounding the Nightlands’ cities. The Waste occupies the areas equivalent to Earth’s oceans and unsettled wildernesses. The Waste is often ravaged by dimensional disturbances (ley line storms, rift activity, etc.) and supernatural creatures are sometimes brought to the Nightlands by these disturbances.

Time-line

2000, March — An unexplainable solar eclipse plunges the whole planet into darkness for 24 hours. Astronomers decide that a previously undetectable body interposed itself between the sun and the Earth. This explanation is accepted and made official. The only people who disagree are occultists and other members of fringe groups.

2000, June — An earthquake shatters Los Angeles, killing 20,000. The ensuing chaos and rioting that follows across California causes the government to impose martial law and mobilize the National Guard.

2000, Summer — Violent crime, disappearances and strange events skyrocket around the world. The U.S. national murder rate nearly triples, with more homicides occurring in three months than in the entire previous year. Through the uncertainty,

a new, powerful political party arises in the United States — the Preserver Party. Fear and insecurity increases the Preserver Party's support. Prior to this sudden and meteoric rise to power, the organization had been a minor player in the political field. Its message is simple: America needs law and order to preserve its basic institutions.

2000, November — For the first time in decades, an independent candidate wins the U.S. elections. Both the Democratic and Republican candidates are racked by scandal, suicides and strange incidents. Douglas Carson of the Preserver Party becomes President of the United States of America.

2001 — Blackouts and brownouts become very common at night. Crime and disappearances continue their steady rise. To

“deal with the problem,” the Preserver Administration, with the support of Congress, starts suspending more and more civil rights.

A plot to overthrow the government, involving many prominent members of the FBI, CIA and other law-enforcement agencies, is “uncovered.” Many lawmen are imprisoned or die while “resisting arrest.” Others go underground.

2004 — President Carson is reelected with an unprecedented 89% of the popular vote, amidst claims of election fraud. Hints abound that Carson may run for a third term. Several prominent journalists are accused of “terrorist activities” and imprisoned. The United States is in an unofficial state of martial law, with the National Security Bureau (NSB) manning the front lines.

How to Play a Role-Playing Game

By Kevin Siembieda

Role-playing games are really just an advanced form of regular board games. In fact, they are so advanced that they no longer use a board. Some of the elements are still the same; you still need paper and pencil, dice and players. But the main thing you need to play a role-playing game is IMAGINATION.

Let's take it a step at a time.

Imagine the Scene

Picture a basement: There is an open step staircase leading down. The walls are covered in an age tarnished, white paint, with large cracks, chips and blotches revealing the red brick underneath. If you turn to look directly opposite from the stairs, the whole basement lies before you. An automatic washing machine and dryer are along the left wall, with water hoses connecting the washer to the large laundry tub and sink next to it. Directly across from the appliances looms the huge iron belly of the gas furnace; its large, old-style heating pipes weaving across the ceiling/floor like tentacles. Storage boxes, old newspapers, rags and dust covered jars, lean against the walls in scattered stacks. In the far wall is a small pantry, a tool shed/workroom and a large, old coalbin. A glance at the solid, glass block windows that rim the right and left walls shows that it's getting dark outside.

Can you picture this scene? Try to keep the mental image in your head. Don't worry if you forget the details; one of the great things about role-playing is the way your memory is improved with practice. Now you are ready for the next step.

Imagine the Setting

A foul odor is mingled with the musty basement air. The coalbin door, which is always kept locked, yawns a foot and a half open. Beyond the door is only blackness. Suddenly, a hoarse, inhuman chuckling begins to rise from below the steps.

Like a cameraman in a film, the scene is established, and now our attention is focused to a specific setting, the stairs. We have also established an atmosphere and the beginning of action. Got all that? Good. Now let's figure out where you, the player, fit into this.

Imagine the Character

Now here comes the tricky part. YOU are not in the basement, but there is somebody whose eyes you see through. That person is your character. An *imaginary individual* that is your playing piece in this game. Just like an actor assuming a *role* for a movie, you play a *fictitious character* in the game. It is your *imaginary character* who is standing on those basement stairs. It is your *imaginary character* who has psychic powers and who reacts and interacts with the other playing pieces, the other characters.

Normally, you will spend an hour or more developing a new player character. Once the character has been created, you will probably continue playing the character for many weeks, perhaps even years.

In our example, your *character* is standing on the lower steps to the basement. The sun is setting and a chilling laughter is softly coming from below the very steps he (or she) is standing on. (Remember the scene, the setting? See how it all comes together now?)

Imagine the Action

Actually, you need one more important ingredient to make a role-playing game work, the **game master**. The game master (G.M.) is another player (a real person) who controls and acts out all the characters in the game which are *not* the characters of other players. It is also the game master who, like the director of a film, establishes the setting, introduces antagonists and

keeps the action moving. This means the game master will play/act out the friendly police officer, the grumpy old man, and the hideous *thing* under the stairs. In this case, you are the only player and I am acting as the game master (G.M.).

The game master says to you: “You hear this hoarse, rasping laugh coming from below the steps you are standing on. You realize that on open steps *it* can grab your ankles. What are *YOU* (your character) going to do?”

At this point, you must decide what your playing piece, *your character*, is going to do. Does he slowly bend down to see what’s under the stairs? Does he try to run up the stairs? Perhaps he leaps down the last few steps and tries to run to the tool shed to get a weapon and bar the door. The decision is yours. The game master will have your opponent(s) respond to your character’s actions. Like improvisational theatre, you, your fellow players and the game master, are all building an adventure, a story. When the game is over, you’ll have a complete chapter of a larger story forever locked in your memory. A story that you helped create.

In a role-playing game there are no simple answers. There are also almost no limits to what you can do. The only restrictions are that you can not go beyond the physical, mental and emotional limits of your *character*.

What You Need to Play

Other than imagination, 2 or more players, and a game master, you will also need the following:

1. Dice: 2 four-sided, 4 six-sided, 2 eight-sided, 2 ten-sided, and 2 twenty-sided.
2. Plenty of pencils and paper.
3. Character log sheets can be xeroxed from this book or simply use paper.

Glossary of Role-Playing Terms

Attributes: These are numbers used to evaluate the strengths and weaknesses of your character. For example: P.P. means Physical Prowess; how smooth, agile and quick a character is in combat. A P.P. of 4 would indicate that the character is pretty clumsy. A P.P. of 9 or 10 would be an average, well coordinated human being. While a P.P. of 16 or higher would belong only to characters with exceptional speed and reflexes. Attributes are also part of a character’s overall *Statistics* or *Stats*.

Campaign: A word used to describe an ongoing game with the same characters. If you play the same characters with the same game master on a regular basis, then you are in a Campaign. A campaign can be one long adventure or numerous adventures of varying length.

Character: Every player (except the G.M.) has a character that serves as an imaginary playing piece; also called *Player Character*.

Death: Just as in real life, these fictional characters can die. The death of heroes in comic books, or in games, is usually a fairly rare event (and hopefully, a noble or heroic sacrifice). The amount of death in a campaign usually depends on the individual Game Master and the world setting. In *Nightbane*, the world is incredibly dangerous and violent, so death may be a bit more commonplace than in other games.

Players should take a character’s death calmly. Remember, it’s *ONLY* a game. Game Masters (G.M.s) should allow players to roll up a “NEW” character and include it in the game as soon as it is appropriate for the ongoing adventure; it’s no fun sitting out a game for long periods of time. However, characters should not be a dime a dozen.

Dice: There are a variety of different dice used in role-playing games. First of all, there are the standard six-sided dice; the kind you use for most board games. We call them “D6.” To indicate how many dice to roll for a *stat* or damage, it will be indicated with an expression like: “roll 3D6.” This means: “Roll *three* six-sided dice and add the results together. “Dice are also available with four-sides (D4), eight-sides (D8), ten-sides (D10), and even twenty-sides (D20). They are available at most hobby stores.

Game Master (G.M.): This is the person who controls the game “world,” sets up and develops the adventures, pacing and serves as the general referee and rules interpreter. All the *non-player characters* (NPCs), innocent bystanders, police, politicians, monsters, Nightlords, and even the weather are controlled by the Game Master. G.M.s should try to be fair and run a *fun* game.

Magic: *Nightbane* and many role-playing games include magic spells, powers, weapons and monsters. Although some of these things may be inspired from myths and legends, *NONE* of them are real! The magic in these games are entirely fictional — make believe.

Occupational Character Class (O.C.C.): This is the character’s educational background and occupational training. It will indicate specific skills, skill selections, goals, orientation, equipment, and salary. An R.C.C. (Racial Character Class) is basically the same thing but restricted to a specific *race*. P.C.C. stands for Psychic Character Class (as described in *Beyond the Supernatural* and *Mystic China*) and applies to characters who have psychic powers and occupations that utilize those powers.

Non-Player Character (NPC): A character that is not played by any of the players, such as villains and others played by the G.M.

Player: A player is a person who plays a fictional character in a role-playing game.

Psionics or Psychic Abilities: Like magic, the psionic powers and abilities described in this book are fictional, although they may be inspired by myths, legends and reports of psychic phenomena.

Role-Playing Game: Sometimes called a role-playing game (RPG), or fantasy role-playing (FRP), these are games that build a story with imaginary characters in a fictional setting.

Role-playing games cover every genre, including horror, fantasy, sword and sorcery, science fiction, cyberpunk, mecha/giant robots, superheroes, and just about everything one can imagine. In fact, the great thing about role-playing games is that the Game Master and players are limited only by their imaginations. Anything is possible.

Roll a Twenty-Sided: Simply roll a twenty-sided die for a number.

Roll Percentile: Take two, ten-sided dice of different colors. Let’s say we have one green and one red. First, you declare which die will be high (“I call red high”). Next, you roll the dice. First, you read the High die and then the Low die; just put the

numbers together and you have a percentile. For example: "Red is 4 and green is 8, so I have a 48%."

Run: This is just a term gamers use to describe playing a game. Example: "He runs an excellent campaign." or "I ran in Kevin's game last week."

Saving Throw: This is a roll (usually on a twenty-sided die) to avoid some unpleasant event, magic spell, or danger. For example: A character might have to roll a saving throw to avoid being overcome by tear gas or to fight off the effects of a spell.

Scenario: This is a specific adventure that confronts the characters in a role-playing game. A scenario is usually a story with a beginning (hearing about the criminal), a middle (tracking down the criminal's hide-out), and an end (defeating the criminal). Most campaigns are developed around a number of scenarios.

Creating a Character

The creation of a character is relatively simple, requiring five main steps:

Step 1: The Eight Attributes (and bonuses)

Step 2: Hit Points and S.D.C.

Step 3: Selecting an Occupational, Racial or Psychic Character Class (O.C.C., R.C.C., or P.C.C.)

Step 4: Equipment and Money

Step 5: Rounding Out One's Character

Step 1: The Eight Attributes & Attribute Bonuses

The first step in creating a character is to roll up the eight attributes: I.Q., M.E., M.A., P.S., P.P., P.E., P.B., and Spd. The eight attributes represent your character's natural, mental and physical abilities. Some of the physical skills, O.C.C. bonuses, and superhuman abilities will increase a character's physical attributes, so it may be wise to write them in pencil until all modifiers and bonuses are accounted for.

Three six-sided dice are rolled to determine each attribute for a typical human (and even most Nightbane start with this basic roll). The higher the number, the greater the ability. If an attribute is "exceptional," (16, 17 or 18) then an additional six-sided die is rolled and added to the total for that attribute.

Intelligence Quotient (I.Q.): Indicates the intelligence of the character. The exact I.Q. is equal to the I.Q. attribute multiplied times ten. A character with an I.Q. of 17 or better will receive a one time bonus added to all the character's skill percentages.

Mental Endurance (M.E.): Measures the amount of mental and emotional stress the character can withstand.

Mental Affinity (M.A.): Shows the character's personal charm and charisma. Natural leaders, with an M.A. of 17 or higher, have a bonus to evoke trust or intimidation in others.

Physical Strength (P.S.): This is the raw physical power of the character.

Physical Prowess (P.P.): Shows the degree of dexterity and agility of the character. A P.P. of 17 or higher is rewarded with bonuses to dodge, parry and strike.



Physical Endurance (P.E.): Demonstrates the character's stamina and durability. The amount of physical punishment, and resistance to fatigue and disease, are determined by P.E.

A character can typically carry a maximum weight load for the P.E. times 4 minutes. Carrying the maximum weight while running or fighting can only be done for the P.E. times 2 minutes. If a character lifts the maximum weight, then it can only be held for as many melee rounds (15 seconds each) as the character has points of P.E. A character can run at maximum speed for one minute for each point of P.E. Characters with a P.E. of 17 or better receive bonuses to save vs. coma, death, toxins, and magic. Also see *Different Applications of Physical Strength*.

Physical Beauty (P.B.): Is an indication of the physical attractiveness of the character. A P.B. of 17 or better will be rewarded with a bonus to charm or impress.

Speed (Spd): Specifically, this is the character's maximum running speed. The Spd. times 20 is the number of yards or meters that the character can run in one minute. The greater the speed attribute number the faster the character can run.

ATTRIBUTE BONUS CHART

	17	18	19	20	21	22	23	24	25	26	27	28	29	30
I.Q. add to all skills. One time bonus.	+3%	+4%	+5%	+6%	+7%	+8%	+9%	+10%	+11%	+12%	+13%	+14%	+15%	+16%
M.E. save vs. psychic attack/insanity	+1	+2	+2	+3	+3	+4	+4	+5	+5	+6	+6	+7	+7	+8
M.A. trust/intimidate	45%	50%	55%	60%	65%	70%	75%	80%	84%	88%	92%	94%	96%	97%
P.S. Hand to Hand Combat: Damage	+2	+3	+4	+5	+6	+7	+8	+9	+10	+11	+12	+13	+14	+15
P.P. parry, dodge and strike bonus	+1	+2	+2	+3	+3	+4	+4	+5	+5	+6	+6	+7	+7	+8
P.E. save vs. coma/death	+5%	+6%	+8%	+10%	+12%	+14%	+16%	+18%	+20%	+22%	+24%	+26%	+28%	+30%
save vs. poison & Magic	+1	+2	+2	+3	+3	+4	+4	+5	+5	+6	+6	+7	+7	+8
P.B. Charm/impress	35%	40%	45%	50%	55%	60%	65%	70%	75%	80%	83%	86%	90%	92%
Spd: No special bonuses other than the raw, natural ability to run.														

Different Applications of Physical Strength

Weight

Normal characters, with a P.S. of 3 to 16, can carry 10 times their P.S. in pounds (P.S.×10 = total in pounds). For Example: A character with a P.S. of 9 can carry 90 pounds (40.5 kg). A character with a P.S. of 15 can carry 150 pounds (67.5 kg).

Strong characters, with a P.S. of 17 or higher, can carry 20 times their P.S. in pounds. This means a character with a P.S. of 18 can carry 360 pounds (162 kg).

Supernatural creatures, including *Nightbane*, are even stronger than extraordinary humans. Supernatural beings and creatures of magic with a P.S. of 18 or higher can carry 50 times their P.S. Thus, a creature with a P.S. of 24 can actually carry over half a ton, 1200 pounds! Creatures with a strength of 17 or less are equal to humans; P.S.× 10 in pounds.

Lifting weight is a little different than carrying weight. You may have noticed, yourself, that you can usually lift up a heavier amount than you can carry. I'm not talking about weight-lifting in a body building sense, nor lifting a heavy weight above the chest. Simply the ability to bend over and lift something that weighs more than you can carry. The simple rule is that a character can lift TWICE as much as he/she could carry. This means that the character with a P.S. of 9 can carry 90 pounds but can

lift 180 pounds. Meanwhile, the supernaturally strong creature, with the P.S. of 24, can lift over one ton (2400 pounds).

Throwing Heavy Objects

A character can not throw more than he can carry.

General Effective Range

Object	Normal Person	Extraordinary	Supernatural
	P.S. 03-16	for Humans P.S. 17-30	Creatures P.S. 18-Up
1/2 pound object	50 feet	100 feet	300 feet
Dart	30 feet	60 feet	100 feet
Throwing Axe	80 feet	150 feet	300 feet
Javelin	100 feet	200 feet	400 feet
Spear	60 feet	120 feet	220 feet
Knife	50 feet	100 feet	200 feet
Sword	15 feet	30 feet	60 feet

Note: Add one foot (0.3 m) to the effective range for every P.S. point; e.g., P.S. 24 add 24 feet (7.3 m).

Objects such as bricks, bottles, and swords are not designed for throwing. Consequently, the effective range is limited regardless of the strength behind it. Darts, knives and throwing axes are designed for throwing, but don't have the weight or bal-

ance for great distances. The same is true of most objects weighing less than half a pound. Javelins, more so than spears, are designed for distance throwing.

Miscellaneous items weighing over a pound (0.45 kg) and less than 10 pounds (4.5 kg), such as rifles, can be thrown about half as far as the 1/2 pound (.22 kg) object. Normal and extremely strong characters can hurl a weight equal to the weight he can carry four inches per each P.S. point. This means the person with a P.S. 9 can toss 90 lbs (40.5 kg) up to 2-1/2 feet (0.6 to 0.75 m) away. The hero with a P.S. of 17 can toss 340 lbs (154 kg) up to 5 ft, 6 inches away (1.75 m).

Supernatural characters can hurl their maximum carrying weight one foot (0.3 m) per P.S. point. So a supernatural character with a P.S. of 24 can hurl an incredibly heavy object (up to 1200 pounds/544 kg) a whopping 24 feet (7.3 m).

Movement and Exertion

Keep the game simple and quick moving. Light activity, such as walking, jogging, driving, standing guard, doing repairs and similar activity, can be conducted for hours without affecting the character adversely. Both players and Game Master should apply common sense and logic to the duration of an activity. Even intense activity, such as 20 minutes of combat followed by rest or light action, will not impair the character's efficiency. It's all a matter of pacing.

Prolonged periods of combat or heavy exertion (an hour or more of intense, continual, physical exertion) will take its toll on the character. Reduce the following once every hour:

Speed -2
Initiative -2
Parry and Dodge -1
Damage -2



Supernatural Strength & Damage

The **Nightbane** and other supernatural creatures inflict a great deal more damage than normal humans, even humans with extraordinary strength. While the strongest human on Earth may be able to bend metal bars and lift great weights, he would not

be able to punch through a metal door or tear through a brick wall. Supernatural beings can do these and other incredible feats. Instead of simply adding the P.S. bonus to damage, supernatural beings use the damage table below to determine base hand to hand damage, and then add P.S. bonuses.

Supernatural damage and hand weapons: When wielding a hand weapon, such as swords, clubs and knives, the supernatural being rolls both for its basic hand to hand damage and the weapon's damage. **Example:** A Nightbane with a P.S. 24 is wielding a sword (1D8 damage). His base hand to hand damage is 3D6+9, so when using a sword he will roll 3D6+9 plus the 1D8 sword damage and add the results together.

Optional Rule: Normal weapons are in danger of breaking when wielded by somebody with supernatural strength. A good rule of thumb is to assume a weapon is in danger of breaking whenever total damage inflicted exceeds more than *three times* the weapon's maximum base damage — in the case of the 1D8 sword, more than 24 points of damage might break the sword. Every time that much damage is inflicted, there is a 01-30% chance that the weapon will break. Heavy, sturdy weapons, and very well-crafted blades (a master smith's katana, for example) can withstand more damage; do not roll unless damage exceeds *five times* the weapon's maximum damage. Magical weapons and artifacts are basically indestructible and are at no risk of breaking.

Supernatural Strength Damage

Add the P.S. damage bonuses to all these attacks.

P.S. 15 or less: Inflicts 1D4 S.D.C. on a restrained punch, 1D6 on a full strength punch, or 2D6 S.D.C. on a power punch (counts as two melee attacks).

P.S. 16 to 20: Inflicts 1D6 S.D.C. on a restrained punch, 2D6 on a full strength punch, or 4D6 on a power punch (counts as two melee attacks).

P.S. 21 to 25: Inflicts 2D4 S.D.C. on a restrained punch, 3D6 on a full strength punch, and 6D6 with a power punch (counts as two melee attacks).

P.S. 26 to 30: Inflicts 2D6 S.D.C. on a restrained punch, 4D6 on a full strength punch, or 1D4×10 on a power punch (counts as two melee attacks).

P.S. 31 to 35: Inflicts 2D6 S.D.C. on a restrained punch, 5D6 on a full strength punch, or 1D6×10 on a power punch (counts as two melee attacks).

P.S. 36 to 40: Inflicts 2D6 S.D.C. on a restrained punch, 6D6 on a full strength punch, or 2D4×10 on a power punch (counts as two melee attacks).

P.S. 41 to 50: Inflicts 2D6 S.D.C. on a restrained punch, 1D6×10 on a full strength punch, or 2D6×10 on a power punch (counts as two melee attacks).

P.S. 51 to 60: Inflicts 2D6 S.D.C. on a restrained punch, 2D4×10 on a full strength punch, or 3D6×10 on a power punch (counts as two melee attacks).

Step 2: Hit Points & S.D.C.

Hit points might best be thought of as life points because they indicate how much physical damage (cuts, bruises, etc.) the character can withstand before he/she dies. These are the points that are observed during a battle (or melee) to determine how

much damage is inflicted on friend or foe. Each time a character is struck by a weapon he takes physical damage. The individual players keep score of how many hit points their character has by subtracting the damage from his/her character's hit points each time that character is hit by a weapon. Likewise, the Game Master keeps score of how much damage the player inflicts upon his opponent. When a character has zero hit points, he is in a coma and will soon die unless extensive medical aid is applied. When a character's hit points have been knocked far below zero, he is dead and beyond saving.

Determining Hit Points

Now that you have some idea of what hit points are about, let us get into the technical aspects of their determination and use.

1. Base Hit Points: Having rolled up your 8 attributes, you will recall that one is physical endurance (P.E.). The physical endurance score indicates a character's base/starting amount of hit points. This number means that he can lose that many hit points before dying.

Some players will have a character with a lot of hit points, but don't get too cocky, a gun or even a knife can whittle you down to size in one melee round and a supernatural monster might chop a character down with a few punches. Others will find themselves with a character who has only a handful of hit points (as little as 3). Don't despair or feel cheated, you'll just have to use cleverness and cunning in avoiding direct confrontations until you've built up your hit points or acquire some body armor.

2. Building Hit Points: After determining your base hit points, pick up one six-sided die, roll it, and add the number rolled to your hit point base. Only roll one six-sided die one time.

As your character grows in knowledge and experience he/she will gain more skill and expertise in his chosen profession. At the same time he will also mature physically, increasing his hit points. Thus, each time a character attains a new experience level, roll one six-sided die and add it to the existing number.

3. Notes on Supernatural or Non-Human Characters: The previous information applies to the creation of normal human beings. This includes the Nightbanes' human forms (also known as the Facades). Supernatural beings (including the Nightbanes' Morpheus forms, the minions of the Nightlords, and others) tend to have many *more* hit points than normal humans. These changes are noted in the individual **Racial Character Class (R.C.C.)** descriptions. Keep in mind that even the toughest Nightspawn can still be mowed down by concentrated gunfire or even several humans equipped with primitive hand weapons.

S.D.C. or Structural Damage Capacity

There are two types of S.D.C. The first applies to *living creatures* and is a sort of supplement to hit points. The second applies to inanimate, *non-living* structures such as chairs, locks, doors, buildings, vehicles, and so on.

Determining physical S.D.C. is simple. Characters with a military, police, detective, or athletic occupation or background roll 1D4×10 for S.D.C., while all others roll 3D6 for S.D.C. This S.D.C. base can be increased through physical skills, such as boxing, body building, etc. In this way, a player can build and toughen a character as much as he or she desires. *All S.D.C.*

points/bonuses are cumulative. Nightbane and supernatural creatures will have additional S.D.C. bonuses, reflecting their inhuman toughness. Even so, they are still vulnerable to blade and bullet, tooth and claw.

When a character is injured or hurt, the damage is first subtracted from his or her S.D.C. points. S.D.C. damage is painful, but not deadly. It's like a movie where John Wayne gets shot, punches it out with three desperadoes, and when it's all over, dusts himself off and says "Ah shucks mam, it's only a scratch"; S.D.C. in action.

It is only after ALL S.D.C. has been depleted that damage is subtracted from hit points. Hit point damage is serious, and potentially life threatening.

Inanimate objects, such as buildings, vehicles, furniture and so on, also have S.D.C. points. In this case, the S.D.C. indicates the total amount of damage that the object can withstand before it breaks, crumbles or is destroyed.

These S.D.C. function exactly like hit points, except that they apply to non-living things. Any damage sustained is subtracted from the S.D.C. When the S.D.C. is reduced to zero, it is broken or smashed beyond repair.

A note to the Game Master: The S.D.C. system just described is a standard rule in most Palladium Books games. From time to time I hear the complaint, for example: How can somebody be bashing or shooting into a door and the door is in perfect condition until all its S.D.C. are depleted? My answer is: It's not in perfect condition. Using the example of the door, the G.M. should explain exactly what's happening. "You bash into the door with your shoulder. It's a very solid door and you inflict minimal damage (give S.D.C. damage). You realize that it will take quite a while to gain entry this way and you may hurt yourself." Or "You can feel the door give a little under your great strength (give S.D.C. damage). Another bash and the door's frame cracks and moans, but it still holds (give S.D.C. damage). It will take another couple of attempts (as the door's S.D.C. dwindles), but it's definitely giving." Or "Your sub-machinegun riddles the wood door with a dozen holes (something the player can look through), but the door is still locked and holding strong."

Obviously, attacks on normal objects will scrape, dent, crack, splinter, crumble and so on, even if the object is not destroyed. To smash or destroy something may require multiple attacks, and in some cases, like being locked behind an iron door or bulkhead without a weapon or proper tools, it will be impossible to damage the item at all.

Recovery of Hit Points & S.D.C.

After a battle, characters who have sustained physical damage must tend to their wounds. The attending of wounds can be administered by fellow characters, trained medical personnel or by oneself, if the character has the *first aid skill* and is not physically impaired.

First aid-type treatment include basic and immediate medical applications and methods such as the cleaning and bandaging of wounds, stop bleeding, the use of antiseptics, and so on, until the character can receive better medical care.

Recovery: Non-professional treatment. This is basic, first aid treatment or well intentioned help from non-medically

trained people. This type of treatment may be used if the character is not able to seek professional treatment immediately. It is not necessarily inferior treatment, especially for minor injuries or ailments, but just lacks the full facilities and experience of a major medical institution. **Rate of Recovery:** Two hit points per day (24 hours) and/or 4 S.D.C. points per day.

Recovery: Professional treatment. This is medical treatment from a doctor, clinic, hospital, or psychic healer. **Rate of Recovery:** Two hit points per day for the first two days, and four hit points per day for each following day, until the character has regained all his/her original hit points. S.D.C. points are restored at a rate of 6 per day. Nightbane and other nonhuman beings possess superior capabilities and heal much quicker, some even regenerate.

Surviving Coma And Death

When a character's hit points are reduced to zero (or less), he/she collapses, lapsing into a coma. This character is near death and will die in a matter of hours unless he/she receives immediate medical treatment.

How much damage below zero a character can undergo is indicated by the physical endurance (P.E.) attribute. A character can take one point of damage below zero (negative 1, -2, -3, etc.) for each P.E. point. **Example:** A character with a P.E. of 9 will lapse into a coma at zero hit points, but still lives up to a negative 9. However, if the character receives more damage (which is very possible) than the P.E., he is dead, with no hope of recovery. Thus, if a character with a P.E. of 9 takes 10 points or more below zero, exceeding his P.E., he is beyond medical help and dies.

Coma Length

The length of time a character in a coma will survive without treatment is again indicated by the P.E. Add one hour for each P.E. point. **Example:** P.E. 9 = 9 hours, P.E. 10 = 10 hours, and so on.

Recovery From a Coma

Whether or not a character survives the coma and is stabilized (brought back to, at least, one hit point above zero) is determined by the roll of percentile dice. If the player rolls two successful recovery rolls out of three tries, the character breaks out of the coma and is no longer in danger of dying. This also means that he is brought up to one hit point above zero. Recovery of hit points from that time on is standard; see *Recovery of Hit Points*. **Note:** This can be attempted every hour.

Recovery Ratio (roll 2 out of 3)

- Treatment from nonprofessional, medical individual, but with medical skills: 1-18%.
 - Treatment from an intern or nurse (R.N.): 1-32%.
 - Treatment from a doctor without proper facilities: 1-46%.
 - Treatment from a doctor at a clinic (fair facilities): 1-56%.
 - Treatment from a hospital: 1-66%.
 - Treatment from a major, large hospital: 1-70%.
-

Optional Recovery Side-Effects From Severe Damage/Near Death (Hit Points)

Roll on this table when a character has lost all of his/her hit points and has been near death (coma). *Impairment is permanent* as a result of the grave physical damage. **Note:** This is not a mandatory table, but is left up to the game master's discretion.

01-10 No permanent damage.

11-20 Major stiffness in joints; reduce P.P. by 2.

21-39 Minor stiffness in joints; reduce P.P. by 1.

40-55 Legs impaired; walk with a limp, reduce Spd by 2.

56-70 Major scarring; reduce P.B. by 2.

71-82 Chronic pain; reduce P.E. by 1.

83-92 Minor brain damage; reduce I.Q. by 1.

93-00 Major brain damage; reduce I.Q. by 2 and M.E. by 1.

Optional Damage Rules

A character receives serious physical damage when he loses a great amount of hit points. The following is a list of side-effects from physical damage. The effects of the damage are generally temporary and cumulative. Thus, if a character suffers severe damage within a short period of time, he or she will suffer the multiple effects of physical damage. Roll each time severe damage is endured.

Optional, Minor Injury Table

Note: None of these effects are permanent or life threatening. Minuses apply to that one limb. Speed minuses affect the whole body. Remember, effects are cumulative; roll each time the character is badly hurt.

Duration is typically about 1D4 days unless indicated otherwise

01-14 Minor bruises and lacerations. -2 on Spd and -1 to dodge.

15-29 Severely bruised and battered muscles. -1D4 on Spd and -1 to P.P. and P.S.

30-44 Damaged (sprain, pulled, cut, etc.) arm or shoulder. -3 to P.P. attribute and -2 to parry. Duration of injury is 3D4 days.

45-59 Damaged leg or hip. Speed is reduced by half and the character is -2 to dodge. Duration is 3D4 days (unless magically or psychically healed).

60-74 Damaged hand and/or wrist. -1 P.P., -2 P.S., cannot lift a weight of more than 10 lbs (4.5 kg) with that hand, and the character is -10% on all skills that require the use of the hands.

75-89 Head Injury: -5% on all skills and -1 on Spd.

90-00 Damaged back or pelvis. -1 to P.E., reduce attacks per melee round by one, and Spd by 50%. Furthermore, the character cannot lift or carry more than 10 lbs (4.5 kg) without excruciating pain (double penalties from the pain). Duration is 3D4 days (unless magically or psychically healed).

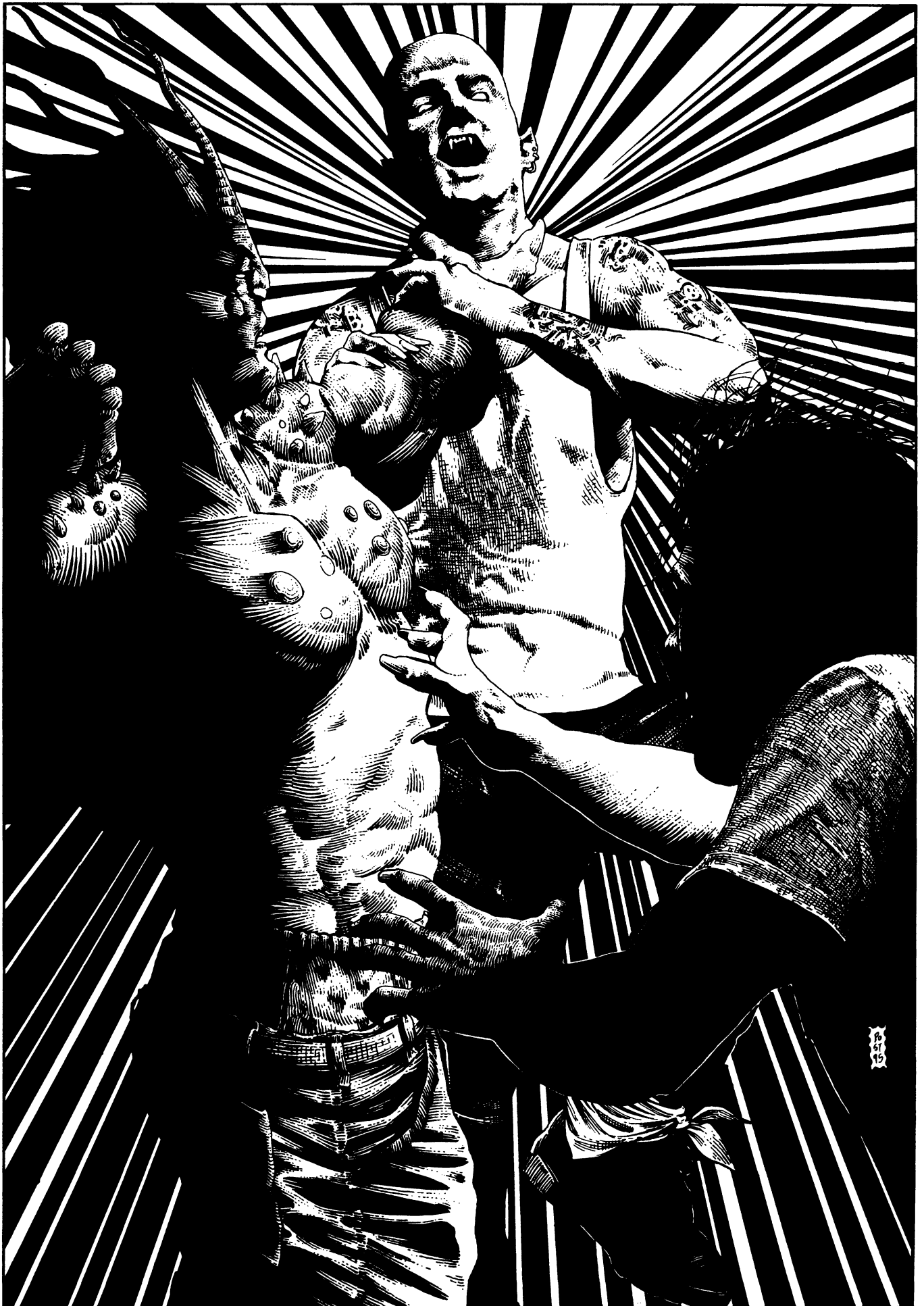

Optional Side-Effects from Physical Damage (Hit Points)

Roll on this table when 80% to 99% (almost all) of hit points are depleted. Impairment is temporary, but lasts 1D4 weeks.

- 01-10 Severely battered and bruised.** Reduce Spd by half, combat bonuses by 2 points, and -3 to dodge.
- 11-20 Torn arm muscle.** -3 to P.P., -2 to P.S., -1 attack per melee round, -2 to strike or parry, and the character cannot lift or carry more than 10 lbs (4.5 kg) without excruciating pain (double penalties from the pain).
- 21-29 Torn leg muscle.** Reduce Spd by half and -2 to dodge.
- 30-39 Fractured bone: arm.** Reduce P.P. and P.S. by 40%, -5 to strike or parry, and the character cannot lift or carry more than one pound (0.45 kg) without excruciating pain (double penalties from the pain).
- 40-49 Fractured bone: leg.** Reduce Spd by half (if in a cast; -80% if not) and -4 to dodge.
- 50-59 Fractured bone: ribs or pelvis.** -2 to P.E., reduce attacks per melee round by one, and Spd by 50%. Furthermore, the character cannot lift or carry more than 5 lbs (2.3 kg) without excruciating pain (double penalties from the pain).
- 60-69 Broken bone: ribs or pelvis.** -4 to P.E., reduce attacks per melee by half, and Spd by 80%. Furthermore, the character cannot lift or carry more than 5 lbs (2.3 kg) without excruciating pain (double penalties from the pain). Double duration unless healed by magic or psychic powers.
- 70-79 Punctured lung.** -4 to P.E., reduce attacks per melee by half, and Spd by 80%. Furthermore, the character fatigues three times faster than normal.
- 80-89 Weakened immune system and fever.** The character is weak, has caught a virus and suffers from a constant low-grade fever, chills, and fatigue. Reduce P.E. by half, P.S. and P.P. by 25%, reduce attacks per melee round and combat bonuses by half, and Spd by 40%. Furthermore, the character fatigues twice as quickly as normal.
- 90-00 Severe concussion.** Reduce attacks per melee and all combat bonuses by half, reduce speed by half, and the performance of all skills is at -30%.

Step 3: Selecting a Character Class

In **Nightbane**, there are three major varieties of Character Classes available to player characters. **Occupational Character Classes (O.C.C.s)** are determined by what the character does for a living. For the most part, these are normal men and woman defined by their chosen profession. Some O.C.C.s include Police Officer, Doctor, Scientist, Spy, etc.

Racial Character Classes (R.C.C.s) apply to characters who are not human, but belong to another species — in the **Nightbane** world, most such species are supernatural in origin. R.C.C.s have all the attributes (which may be higher or lower than human equivalents), special bonuses and abilities, and the description of the race in question. Some R.C.C.s may have skill lists, or suggested O.C.C.s characters which that race might pursue.

Finally, **Psychic Character Classes (P.C.C.s)** are basically human beings who have special powers and abilities, usually psionic or magic in nature.

While most player characters in the **Nightbane** world will belong to the **Nightbane R.C.C.**, some players may wish to try something else for variety. It is up to the game master to decide whether or not specific O.C.C.s, R.C.C.s and P.C.C.'s will be appropriate for his/her campaign. Different beings from a variety of worlds can be found in **Beyond the Supernatural, Rifts RPG, Rifts Conversion Book**, and other Palladium products. Of course some modifications may be required.

Skills and Skill Selection

Each O.C.C. has three skill categories: O.C.C. skills, O.C.C. related skills, and Secondary skills.

O.C.C. skills are the areas of expertise and training that all characters receive when they select that profession. The bonus in parentheses reflects that specialized training.

O.C.C. Related Skills are additional areas of formal training and knowledge. In many cases, these skills will also reflect the character's occupation and interests. Not all skill categories are available for skill selection and will be marked "none." Many of the skill categories that are available will indicate specific restrictions (if any) and possible skill bonuses. Skill bonuses will be indicated in parentheses. The skills that most relate to one's O.C.C. have the highest bonuses.

Secondary skills are things that have been learned without formal training. They are hobbies, interests, and abilities that a person has learned himself by reading, or watching others and practicing what he has seen. These skills are also selected from the list of available skill categories. However, **no** skill bonuses are applicable! The bonus indicated in parentheses applies only to "other" skill selections. Thus, all secondary skills start out at the Base Skill level.

Skill Bonuses

The base skill level is denoted in each skill description. Bonuses received by one's O.C.C. are added to that base skill. This is a one time skill bonus.

Characters may also have an I.Q. attribute bonus and this too is added to the base skill level as a one time bonus.

Skill proficiencies increase as characters grow in experience. This is not so much a bonus as a designation of increased mastery over one's abilities. The amount that the skill level increases is also noted in each skill description. **For example:** The communication skill of *radio: basic* reads: **Base Skill:** 45%+5% per level of experience. This means that a first level character without O.C.C. or other bonuses has a base skill proficiency of 45%. At second level +5% is added to increase the skill to 50%. At third level it increases to 55%, at fourth, 60%, and so on.

Maximum skill level is limited to 98%, because there is always a margin for error no matter how skilled one is.

P.P.E. Points

P.P.E. Points are the amount of potential psychic energy (P.P.E.) that a character possesses. P.P.E. is necessary to cast spells and for other mystical needs. Unless stated otherwise under one's O.C.C., R.C.C. or P.C.C., the amount of P.P.E. is minimal in adults, particularly humans, roll 2D6.

Step 4: Equipment and Money

All characters are given a basic list of standard equipment typical for that O.C.C. Likewise, each character has a certain amount of money in the form of cash or savings. This means that the character starts out with the basics and some cash; poor, but not destitute. Money is a great motivator for action in a role-playing scenario, so it is intentionally kept limited to start. Needing a roof over one's head or food in one's belly can lead a character to consider actions that can develop nicely into an adventure. As always, a character can spend the money immediately for additional equipment or save it for later.

Step 5: Rounding Out One's Character

The final step is to add color to your character. The only mandatory requirement is the selection of an **alignment** and understanding how the **experience levels/system** applies to you. Everything else is optional, including insanity. Use it or do not. Insanity rules will be most appropriate in long campaigns.

Alignments

By Kevin Siembieda

The Alignments

Good: Principled and Scrupulous

Selfish: Unprincipled and Anarchist

Evil: Miscreant, Aberrant and Diabolic

ALL players must choose an alignment for their character.

Alignments are an important factor in developing a character and the elements of "role" playing. Whether we are consciously aware of it or not, every person has his or her own code of ethics and morals as well as a sense of justice and what constitutes good and evil, right and wrong. It is this sense of right and wrong that helps to build our moral fiber and mold our behavior and reactions to people, events, and circumstances in the world. It is this code that makes the thought of stealing or hurting somebody abhorrent to one person, but acceptable to another.

So it is with the player and non-player characters in Palladium's role-playing games. The *alignment* of a character is his or her view of the world, justice, honor and the value of life. Alignments should be regarded as a guideline for the character that will indicate how he or she is likely to react to any given situation, violence and good and evil.

It is natural to have conflicted emotions and want to give into hatred or anger and kill or hurt, but characters of a good alignment are not likely to give in to such dark emotions. Similarly, a selfish or evil character may, to his surprise, suddenly find compassion or a sense of loyalty to another character and find himself wanting to help him (which he may or may not do). Moral dilemmas and the conflict they bring are part of life. It is natural to have such feelings even when *playing* a fictional character. It's also what adds to the drama of a situation and part of what makes role-playing fun.

Try to stay in alignment and act accordingly. However, a player may find himself slipping (or slipped) out of character. The G.M. should stop the game for a moment and, as the referee/director of the story, point out that the player's intended actions goes against the character's alignment. The G.M. should then warn that moving forward will cause the character to change alignment. **For example:** A principled good character that acts in hatred and deliberately tortures another being is likely to drop to the *anarchist* or even miscreant alignment. A

principled character who decides to steal or "bend" the law is likely to drop to a scrupulous or unprincipled alignment. Meanwhile, a miscreant evil character who has learned the value of friendship and begins to perform acts of good and compassion, or forsakes his evil/criminal ways, may go up to anarchist or unprincipled (and eventually, even higher). Note that it seems easier to give in to cruelty and dark emotions and thus drop in alignment, than it is to become (or stay) good. A single terrible act of evil can plummet a good character's alignment, but it should take numerous acts of kindness and goodness to climb back to a good alignment (often going up one notch at a time). Playing in character (e.g. in alignment) can be a challenge, but loads of fun.

Neutral

First of all, there is no such thing as an absolute or true neutral. All people tend toward good, evil or self-gratification. An absolute true neutral could not make a decision, go on an adventure, kill, or take any action of any kind without leaning toward good, evil or self-gratification. It is humanly impossible and is, therefore, eliminated in the context of this game. (I realize that some of the philosophers out there may disagree with this, but that's a topic for philosophical debate and not a factor of this game. Sorry, no neutrals).

GOOD ALIGNMENTS

Principled Scrupulous

Because a character is of a good alignment, it does not make him/her a saint. Good characters can be just as irritating, obnoxious, and arrogant, even prejudiced and full of quirks. However, life and freedom are of the highest priority. Such a person can always be trusted in a life and death situation.

Principled (Good)

Principled characters are, generally, the strong, moral character — the "Boy Scout" or do-gooder paladin of the group. He or she is usually compassionate, caring, cooperative and sincere.

Principled characters will . . .

1. Always keep his word.
2. Avoid lies.
3. Never kill or attack an unarmed foe.
4. Never harm an innocent.
5. Never torture for any reason.
6. Never kill for pleasure.
7. Always help others.
8. Work well in a group.
9. Respect authority, law, self-discipline and honor.
10. Never betrays a friend.
11. Never breaks the law unless conditions are desperate. This means no breaking and entry, theft, torture, unprovoked assaults, etc.

Scrupulous (Good)

Scrupulous characters value life and freedom above all else, and despise those who would deprive others of them. This type of hero is typically portrayed in many Clint Eastwood and Charles Bronson films; the person who is forced to work beyond the law, yet for the law, and the greater good of the people. They are not vicious or vindictive men, but are men driven to right injustice. I must point out that these characters will always attempt to work with or within the law whenever possible.

Scrupulous Characters Will ...

1. Keep his word to any other good person.
2. Lie only to people of selfish or evil alignments.
3. Never attack or kill an unarmed foe.
4. Never harm an innocent.
5. Never torture for pleasure, but may use muscle to extract information from criminals or evil characters.
6. Never kill for pleasure; will always attempt to bring the villain to justice alive no matter how vile he may be.
7. Always help others.
8. Attempt to work within the law whenever possible.
9. Bend and, occasionally, break the law when deemed necessary. This means they may use strong-arm techniques, harass, break and enter, theft, and so on.
10. Distrust authority.
11. Work with groups, but dislike confining laws and bureaucracy (red tape).
12. Never betrays a friend.

SELFISH ALIGNMENTS (But Not Necessarily Evil)

Unprincipled (Selfish)

This, basically, good person tends to be selfish, greedy, and holds his/her personal freedom and welfare above almost everything else. He/she dislikes confining laws, self-discipline and distrusts authority. This is the Han Solo, Star Wars, character. The guy who is always looking for the best deal, associates with good and evil characters, is continually tempted to lie and cheat, and hates himself for being loyal and helping others.

Unprincipled Characters Will . . .

1. Have a high regard for life and freedom.
2. Keep his word of honor.
3. Lie and cheat if necessary (especially to those of anarchist and evil alignments).

4. Will not kill an unarmed foe (but will take advantage of one).
5. Help those in need.
6. Not use torture unless absolutely necessary.
7. Work with a group, especially if profitable.
8. Never harm an innocent.
9. Never kill for pleasure.
10. Dislike authority.
11. Never betray a friend.

Anarchist (Selfish)

This type of character likes to indulge himself in everything. He is the insurgent, con-man, gambler and high roller; the uncommitted freebooter seeking nothing more than self-gratification. This character will, at least, consider doing anything if the price is right. These people are intrigued by power, glory and wealth. Life has meaning, but his has the greatest meaning. Laws and rules infringe on personal freedom and were meant to be broken. An anarchist aligned person is always looking for the best deal, and will work with good, selfish or evil to get it; as long as he comes out of the situation on top. The anarchist is continually teetering between good and evil, rebelling, and bending the law to *fit* his needs. Often mercenaries fall into this category.

Anarchist Characters Will . . .

1. May keep his word.
2. Lie and cheat if he feels it necessary.
3. Not likely to kill an unarmed foe, but certainly knockout, attack, or beat up an unarmed foe.
4. Never kill an innocent (but may harm or kidnap).
5. Not likely to help someone without some ulterior motive (even if it's only to show-off).
6. Seldom kill for pleasure.
7. Use torture to extract information (not **likely** to torture for pleasure).
8. Does not work well in a group (this is the cocky, loudmouth who is likely to do as he damn well pleases).
9. Have little respect for self-discipline or authority.
10. May betray a friend.

EVIL ALIGNMENTS

Miscreant

Aberrant

Diabolic

All evil characters are not bent on universal genocide or domination over all living creatures. They are not all maniacal people actively seeking to harm innocent people. Nor are all evil characters sadistic and untrustworthy. Many evil characters may actually seem kind or likable.

There is nothing wrong with playing an evil character, although he may not survive too long if he betrays or harms too many people. This is fantasy role-playing, not reality. You can play any type of character you desire, just continue to play in character.

Evil alignments are a step beyond the self-gratification of the selfish alignments. Evil characters are ruthless individuals who are willing to say or do anything to achieve their goal. Human life has little meaning to them, and friends tend to be (but not always) people to use, and discard when they are no longer of value. Evil aligned people do not automatically slay any good

aligned person because of different ethics and philosophy. All the better to use good to achieve their own goals, for the end always justifies the means.

Miscreant (Evil)

This self-serving, unscrupulous character is out only for himself. Power, glory, wealth, position, and anything that will make his life more comfortable is his goal. It matters not who gets caught in the middle, as long as he comes out smelling like a rose. This person will lie, cheat and kill anyone to attain his personal goals.

Miscreant Characters Will . . .

1. Not necessarily keep his word to anyone.
2. Lie and cheat anyone; good or evil.
3. Most definitely attack an unarmed foe (those are the best kind).
4. Use or harm an innocent.
5. Use torture for extracting information and pleasure.
6. May kill for sheer pleasure.
7. Feels no compulsion to help without some sort of tangible reward.
8. Work with others if it will help him attain his personal goal.
9. Kill an unarmed foe as readily as he would a potential threat or competitor.
10. Has no deference to laws or authority, but will work within the law if he must.
11. Will betray a friend if it serves his needs.

Aberrant (Evil)

The cliché that there is “No honor among thieves” is false when dealing with the aberrant character. This is a person who is driven to attain his goals through force, power, and intimidation. Yet the aberrant person stands apart from the norm, with his own, personal code of ethics (although twisted ethics by the standards of good). He expects loyalty from his minions, punishing disloyalty and treachery with a swift, merciful death. An aberrant person will always keep his word of honor and uphold any bargains. He will define his terms and live by them, whether anyone else likes it or not.

Aberrant Characters Will . . .

1. Always keep his word of honor (he is honorable).
2. Lie to and cheat those not worthy of his respect.
3. May or may not kill an unarmed foe.
4. Not kill (may harm, kidnap) an innocent, particularly a child.
5. Never kills for pleasure.
6. Not resort to inhumane treatment of prisoners, but torture, although distasteful, is a necessary means of extracting information.
7. Never torture for pleasure.
8. May or may not help someone in need.
9. Work with others to attain his goals.
10. Respect honor and self-discipline.
11. Never betray a friend.

Diabolic (Evil)

This is the category where the megalomaniacs, violent, and most despicable characters fall. This is the cruel, brutal killer who trusts no one and has no value for anyone or anything that gets in his way. Aberrant aligned characters find these dishonorable people just as revolting as a good aligned character.

Diabolic Characters Will . . .

1. Rarely keep his word (and has no honor).
2. Lie to and cheat anyone.
3. Most certainly attack and kill an unarmed foe.
4. Use, hurt and kill an innocent without a second thought or for pleasure.
5. Use torture for pleasure and information.
6. Kill for sheer pleasure.
7. Likely to help someone only to kill or rob him.
8. Not work well within a group (consistently disregarding orders to do as he pleases).
9. Despise honor, authority, and self-discipline.
10. Associate mostly, with other evil alignments.
11. Betray friends (after all, you can always find friends).



Supernatural Creatures

Supernatural creatures (especially villainous NPCs) must have an alignment. Most will be evil; especially miscreant and diabolic. ALL supernatural creatures, whether they are ghostly entities or slithering monsters, will radiate their alignment. This psychic emanation is part of its nature and can not be hidden or disguised. To a psychic sensitive, the emanations of evil are as distinctive and recognizable as a pungent odor.

Human practitioners of magic for evil purposes, or individuals who associate with evil supernatural creatures, do not, themselves, radiate an unnatural evil aura. However, those who knowingly and willfully use such dark forces are always of evil or anarchist alignment. These are the vengeful, greedy or power hungry fools who will stop at nothing to achieve their goals. Goals they will attain even if it means calling upon horrible, evil forces from another world to prey on their own kind.

Nightbane , Wampyrs and Guardians, despite their supernatural powers, do NOT radiate an alignment or an aura of supernatural evil. Psychics will recognize them as supernatural beings, but will be unable to truly sense their intentions or disposition.

Experience Points

Except in specially devised scenarios and tournaments, there is no winner in a role-playing game. The accumulation of heroic deeds, friends, prestige, weapons, equipment, knowledge, and skills, can be construed to be the results of winning. If a character survives and meets with success in his endeavors, that is winning. However, there are rewards besides the acquisition of material goods and reputation, and those are developing your character's skills, knowledge, and abilities. This is accomplished through the gathering of experience points.

Why An Experience Point System?

By Kevin Siembieda

The reason I use an experience point system is because I find them extremely realistic and practical. Training is useful, but there is no substitute for experience. I don't know how many times I have read a comic book with the main character thinking to himself, something like "Only my years of experience enabled me to beat him." or "He's good, but lacked the years of experience and training to handle the situation." Practical experience in the field is an important and real factor in the development of a character.

The experience system is specifically designed so that characters will mature fairly rapidly, tapering off as they reach higher levels of experience (around fifth and sixth level).

Why do the experience levels only go to level 15? Because characters are not likely to ever reach that level, even after years of regular play. In my original, **Palladium Role-Playing Game** play-test campaign, after two years of regular, weekly, long (averaged 9 hours) playing sessions; the characters averaged 7th to 9th level and progressing, ever so slowly, toward tenth level. Realistically, a high level character is not necessarily all that much fun to play unless the campaign maintains a high level of challenge and adventure.

Experience Points And Their Application

It is difficult to devise a point system by which a game master can judge and reward his players fairly. The ultimate purpose of experience points and experience levels is to provide a means by which the player's character can grow and develop. Many fantasy role-playing games have their own unique system, charts, equations, and computations for distributing experience points. You may want to adapt one of these systems to this game if that's what you're comfortable with. Many games avoid the whole question of experience points by using a system in which points are pumped back into the powers, but this leaves skills undeveloped, as well as being pretty drab.

The subjective method of observation and logic introduced in the **Palladium Role-Playing Game** has been so well received that I'm just transplanting it into *Nightbane* and all of our games. I feel that any twit can punch-out or blast a villain that just crawled out of the woodwork. Most experience systems concentrate on the "kill factor," but what about the thought process? What about the decisions, plans, or motives behind a particular

action? Doesn't cleverness and a cool head count? Aren't these the true ingredients of good role-playing? Shouldn't the brilliant medical student playing a character with an I.Q. of 4 (and staying firmly in character, saying and doing things as the character would, even though he realizes the stupidity as a player) get experience for playing in character? Hell Yes!!! Considering how flexible and subjective most of the other role-playing conditions and rules are, I don't see the logic in having a strict, limited experience point system.

Each player's character involved in a given situation/confrontation should receive the appropriate experience points. The game master should make a list of his players at the beginning of the game and jot down each player's experience points as they gather them throughout the course of the game. At the end of the game, the game master totals each player's points and gives them the total so that they can keep track of their growing experience and skills.

The difficulty with this system of determining experience points is the subjectivity. The game master must utilize the proceeding experience outline with some thought. **Example:** Eight third level characters brimming with psychic power and armed to the teeth attack and subdue one, lone, fourth level villain or minor monster. The eight players should receive experience points for subduing a minor menace. After all, the poor guy didn't have a chance and presented no real threat to the characters. However, if one or two first or second level characters subdued the same villain, they should receive experience for subduing a major or even a great menace, because the threat and ingenuity involved are much greater.

I have found this method stimulates imaginative playing instead of promoting slash and kill. Game masters, don't be Santa Claus heaping wonderful amounts of experience points; be fair and tolerant. Let your players truly earn their experience points; growing in skill, knowledge and power. If you have a group of players rising rapidly in experience levels, you will know it's because they are clever and imaginative players. And that's what this game is all about!

Character Experience Levels

Each character class has a listing for levels of experience. A character involved in an adventure gains experience points for his thoughts, actions and deeds. As these experience points accumulate, the character will reach new plateaus, indicating his continual growth, development, and mastery over his powers and skills. Each time a player's character accumulates enough experience points to reach the next level of experience, his skill increases accordingly. In most instances, magic and special powers also increase in range, duration, power/damage, and scope. **Example:** When a first level scientist character has accumulated at least 2051 experience points, he has attained second level, and all his skills become second level; meaning that he can perform them at a higher level of proficiency.

A clever plan, a quick attack, all earn experience points. The more experience points a character receives, the higher the level

he attains and the greater his abilities. **Players**, be certain to keep a careful record of the experience given to you at the end of each game. When a character attains a new level, be certain to tell the game master so that the skills and hit points can be increased accordingly.

Experience And Hit Points

Each time a character reaches a new level of experience the player gets to roll 1 six-sided die and adds the number rolled to the character's hit points. This indicates the physical development and maturity of the character as he develops.

Per Level Of Experience

Per level of experience, or per each level of experience, or per level of the psychic, indicates that the person can perform a skill, psychic power, or ability at his highest level of experience. This often indicates the amount of damage that can be inflicted or a duration of an effect.

EXPERIENCE POINTS TABLE

Action	Experience Points
25	Performing a skill (successful or not).
25	Clever, but futile idea.
100	Clever, useful idea or action.
100	Quick-thinking idea or action.
200	A critical plan or action that saves the character's life and/or a few comrades.
400-1000	A critical plan or action that saves the entire group or many people.
100-300	Endangering the character's own life to help others.
500-700	Self-sacrifice (or potential self-sacrifice) in a life and death situation (like leaping in front of a fireball meant for someone else to save that person, even though he/she is likely to die, or offering his/her own life to save the group or another).
100	Avoiding unnecessary violence.
100-200	Deductive reasoning and/or insight.
50	Good judgment.
50	Playing in character bonus.
50-100	Daring (clever or not).
25-50	Killing or subduing a minor menace.
75-100	Killing or subduing a major menace.
150-300	Killing or subduing a great menace.



Insanity

In the context of this game, we will assume that all player characters are mentally and emotionally sound. Any insanities, developed from this point on, will be the result of trauma. A psychological trauma may result from a violent, emotional experience or shock. As psychic investigators, the characters will be somewhat prepared and hardened to frightening, unnatural or bizarre experiences. A trauma that will result in an insanity will have to be quite horrible.

TRAUMA

I've found that having a character roll on the insanity tables after a terrible trauma is very appropriate, realistic and fun; adding a new element to the game. What constitutes a traumatic experience is, in part, up to the game master and the actual situation.

The following is a guide to some traumatic situations requiring a roll on the Random Insanity Tables.

Long period of physical and/or mental torture.

Two to eight weeks: Roll once on the Insanity Table. Nine weeks to months: Roll once on the Insanity Table and once on the Neurosis Table.

Drug Induced Hallucinations that were particularly terrifying, hideous, or realistic.

Roll once on the Phobia Table. If extremely traumatic, lengthy, or reoccurring hallucinations, roll on the Random Insanity Table. A real life encounter with the subject of a traumatic hallucination is likely to cause more trauma. 70% chance of developing another insanity; roll on the Random Insanity Table.

Witnessing or experiencing a shockingly grotesque atrocity.

Roll on the Phobia Table.

Terrible, frightening or unusual brush with death.

Roll on the Random Insanity Table.

Witnessing the terrible or shocking death of a deeply loved one.

Roll on the Psychosis Table.

Severe physical disability.

60% chance of alcoholism or drug addiction.

The cause (accidental) of several innocent peoples' deaths.

(applies to characters of a good alignment).

Roll on the Random Insanity Table.

INSANITY TABLES

RANDOM INSANITY TABLE

(Resulting from Trauma) Roll percentile dice.

1-10 **Reborn**; alignment reversal; good becomes evil, evil becomes good (selfish becomes principled or scrupulous).

11-20 **Neurosis**; roll on the table that follows.

21-25 **Compulsive Liar**; even if of a good alignment.

26-30 **Kleptomaniac**; a compulsion to steal, even if of a good alignment.

31-40 **Obsession**; roll on the table that follows.

41-50 **Phobia**; roll on the table that follows.

51-60 **Psychosis**; roll on the table that follows.

61-70 **Fear of Animals**; see neurosis.

71-80 **Recluse**; prefers to be alone, quiet, unobtrusive.

81-90 **Affective Disorder**; roll on the table that follows.

91-00 **Fear of the Dark**; see neurosis.

Note: More than one phobia, obsession, psychosis, or affective disorder is possible. If the same one is rolled, ignore it and roll again.

RANDOM INSANITY TABLE (Optional)

1-19 Affective Disorders

20-45 Neurosis

46-65 Phobia

66-85 Obsession

86-00 Psychosis

AFFECTIVE DISORDERS

1-19 **Frightened** by loud noises to the point of cowering and wetting self.

20-35 **Disgusted** by anything sticky, and will go to any length to avoid touching it.

36-54 **Obsessed** with cleanliness, and must clean up any area he/she is at for more than a few minutes.

55-75 **Outraged** by acts of violence, becoming violent himself; 72% chance of going berserk and attacking the perpetrator of the violent act without regard for self. Bonuses: +1 to strike, +2 to damage.

76-88 **Hates** music and musicians, and will try to destroy or stop the source of those terrible noises.

89-00 **Intimidated** by spoken language; cannot speak meaningful sentences, and must use sign language or written communication.

NEUROSIS

1-18 **Fear of the Dark** (spent much time locked in closets) to the point of gibbering and total collapse while in the dark.

19-34 **Fear of Animals** (chewed on by the family pet while a nipper) to the point of running away when confronted by small, furry things.

35-49 **Cannot tell the Truth**; compulsive liar, even if of a good alignment.

50-64 **Invasion of the Body Snatchers**: Acute paranoia toward all supernatural entities, those of alien heritage and even humans born off the Earth. ("They're out to get ya! They could be anybody!! even you!!").

65-85 **Fear of Heights** (Uncle Goober used to dangle the character, by one foot, out of windows) to the point of being frozen above the second story; character is fine as long as ground is not visible.

86-00 **Fear of Success** (Mom always said you weren't any good): Character will sabotage self at critical moments. The following minuses apply during critical, or high pressure moments (battle, danger, watched by others, etc.): -15% to all skills, -3 to strike, dodge, parry and damage.

PSYCHOSIS

1-15 **Hysterical Blindness** when under pressure, 1-89% likelihood of happening — roll for each situation.

16-28 **Paranoid type**; everyone is out to get you/trusts no one.

29-49 **Manic depressive**; alternate severe depression one week (suicidal, nobody loves you — -5% on all skills) with manic episodes the next week (everything is great and I'm the best that there ever was! — +5% on all skills). 30% chance of alcoholism.

50-73 **Schizophrenia**; you are passive and easily frightened; jumpy. You hear voices telling you that all the angels are dead; worry about what angels are. 50% chance of alcoholism or drug addiction.

74-85 **Mindless aggression**; roll percentile:

51-94 Semi-functional: When frustrated, angry, or upset, there is a 72% likelihood of going berserk and lashing out at anyone/everyone around until killed or confined; will take 3-18 (3D6) minutes of confinement to regain composure.

95-00 Non-functional/homicidal: Continually going berserk until confined or killed; have one lucid day a week and try to talk your way out of confinement.

86-00 **Become a psychiatrist** and try to cure everyone around (they're all sick, even if only you have the perspicacity to tell); be sure to demand stiff fees.

PHOBIAS (A deep, overriding fear)

01-03 Undead

04-06 Reptiles

07-09 Scientists

10-12 Mutants

13-15 Snakes

16-19 Ghosts

20-22 Confining Enclosures

23-26 Skeletons

- 27-29 Darkness
- 30-32 Graveyards/Burial Mounds
- 33-35 Abandoned Old Houses/Buildings
- 36-39 Giant Creatures/Monsters
- 40-44 Basements/Cellars
- 45-48 Corpses
- 49-51 Users of Magic
- 52-54 Spiders
- 55-57 Tombs
- 58-61 Cats
- 62-64 Heights
- 65-67 Dogs
- 68-70 Contamination
- 71-73 Psychic Strangers
- 74-77 Insects
- 78-80 Flying
- 81-84 Bats/Bat-Like Things
- 85-87 Water
- 88-90 Computers
- 91-93 Psychic Healing
- 94-96 Open Spaces
- 97-00 Supernatural Entities

Note: If the same phobia is rolled, the player must re-roll.

PHOBIAS

A phobia is an irrational fear which may result from a horrifying/traumatic experience. The object of the phobia can be anything: bugs, snakes, the dark, heights, flying, guns, typewriters, anything which may have been the focus or cause of the severe psychological trauma. While there are scientific names for specific phobias, it is far easier to simply identify the object of the phobia.

To determine a specific phobia, the player can roll on the *random table* which follows, or the game master and player can decide on a phobia which best applies to the severely traumatic experience. In the latter case, the determination of a phobia should be made on a common sense basis. For Example: If a character has had a horrifying experience in a haunted house, walked through spider webs, descended into a dark cellar and encountered a walking skeleton, one of the following phobias could easily apply; fear of empty old houses, fear of the dark, fear of spiders or insects, of cellars, of corpses, etc.

G.M. Note: Dealing with the supernatural will constantly send characters into scary, horrifying, bizarre and deadly situations. But it is only the most horrifying and unexpected experiences that *may* create a phobia or other insanity. Remember, the characters will be prepared and hardened to sights, concepts and creatures that might bedazzle the mind of a normal, unsuspecting person.

Phobic Panic

The character who suffers from a phobia will become terrified when the object of fear is encountered. If the character is surrounded by friends who can talk and soothe away his fears, the person may be able to contain himself long enough to safely avoid it (40% chance). However, if the character is alone, already nervous or feels threatened, he or she will be overcome by fear. This is a phobic panic.

Upon reaching the breaking point, the character's mind will defend itself by causing the character to respond in one of the

following ways. (Roll percentile dice).

1-25 Pass Out/Fall unconscious for 2 to 8 minutes (roll 2D4).

26-80 Flee/run away at top speed. Panic-stricken, the character will ignore the outcry, pleas or needs of his companions. All the terrified person knows is that he or she must escape. The character will run and run until he is certain he's escaped the object of his fear, or until subdued. The person will fight only if there is no other way to escape and then only until he/she can get away and run.

81-00 Paralyzed with fear, the character can only cry, whimper or scream. Physically, the character will stand completely rigid or huddled in a corner, immobilized with fear. He/she can *not* run, use skills, fight or move in any way (no attacks per melee), until the object of the fear is removed or destroyed, or he is dragged away from it.

OBSESSIONS

Obsessions are either an intense, irrational love/desire of something, or an intense hatred/loathing. The former is likely to cause the obsessed person to obtain his desire, while the latter is likely to cause the obsessed person to avoid or destroy the object of his obsession. *The game master* can decide which is most appropriate under the circumstances or roll once on the following table:

Focus of the Obsession

1-50 Love/Desire

51-00 Hate/Destroy

Obsessions

1-5 Timeliness (either a fanatic about being punctual or always late).

6-12 High technology (either loves to acquire/use or loathes it).

13-20 Women (or men, if a woman character)

21-27 Wealth

28-35 Secrecy (either prizes his secrecy above all else, or abhors even the thought of keeping secrets).

36-43 Specific individual.

44-50 Specific object/item or animal.

51-55 Appearance (fashion plate or slob).

56-63 Danger (either loves the thrill of danger, which usually means throwing caution to the wind, the more deadly the better; or, despises danger, overly cautious, worry wart, jumpy).

64-70 Food (covets only the finest foods and drink, or would, just as readily, eat worms and stale food as anything else; a slob).

71-78 Alcohol (either a heavy drinker with a keen taste for the finest liquor, or a fanatical, anti-alcohol prude).

79-86 Gambling (will bet it all, or an anti-gambling fanatic).

87-92 Solitude (either loves quiet and being alone to the point of growing irrationally angry and frustrated if continually bothered or interrupted; or can't stand the thought of being left alone for even short periods of time).

93-00 Crime-busting: Loves it if a hero; obsessed with stomping out crime and evil everywhere. If a villainous "crime lord". Loves the thrill of being a criminal mastermind.

Note: This insanity may drive a character to incredible (even outrageous) lengths, to satisfy his or her obsession.

CURES FOR INSANITY

Affective Disorder or Neurosis: Therapy and counseling, and/or the use of hypnosis. Requires a minimum of three months of therapy, with the following results:

- 1-29 No effect; requires another three months of therapy.
- 30-69 Half cured; person feels occasional return of old neurosis or disorder when under stress, 48% chance.
- 70-00 Total cure.

Psychosis: Therapy and possible use of hypnosis and drugs to control the moods and tension/stress. Requires a minimum of six months of therapy, with the following results:

- 1-33 No effect; requires another six months of therapy.
- 34-68 Psychosis replaced by phobia.
- 69-00 Total cure.

Phobia: There is no cure for phobias, but prolonged or repeated exposure to the object of the fear will lessen the intensity of the fear. Requires a minimum of three months of therapy, with the following results:

- 1-39 No effect; requires more therapy.
- 40-88 Fear is lessened so that the person can function normally, but he/she still doesn't like the phobia object — ugh!
- 89-00 Fear is intensified so that there is a 50% likelihood that the person will become completely paralyzed until the source of the fear is removed, or the person is physically removed.

Therapy sessions generally cost \$75 each, with two sessions per week (this includes treatment for each category of insanity). Similar therapy can help obsessions.

EFFECTS OF ALCOHOLISM

(Roll for effects and disposition while intoxicated)

- 1-10 Mean, hostile, strong; +2 to damage.
- 11-20 Quick temper, argumentative; +1 on initiative, -1 to parry or dodge.
- 21-30 Impulsive, takes risks; +2 on initiative.
- 31-40 Quiet, withdrawn; -2% on all skills.
- 41-50 Paranoid, trusts no one, agitated; +1 on initiative.
- 51-60 Moody, sad; -5% on all skills.
- 61-70 Secure/self-assured only while intoxicated; -2% on all skills when sober.
- 71-80 Depressed, pessimistic; -5% on all skills.
- 81-90 Hyper, agitated, always moving, distracted; -2 on initiative.
- 91-00 Super syndrome; believes he/she is best when intoxicated. +5% on all skills when intoxicated, -10% when sober.

Totally Drunk (staggering)

The alcoholic is in a totally drunken state 25% of the time (intoxicated as often as possible — 80% of the time), and tends to drink even more during a crisis — 50% of the time.

When totally drunk, the following penalties apply:

- * -4 on initiative.
- * -2 to strike, parry and dodge.
- * Reduce speed by half.
- * Reduce all skills by -12%

Alcoholism can be cured, and requires willingness to seek aid, abstinence from all alcohol, therapy and support of friends.

Withdrawal Symptoms:

First Week: -5% on all skills, -2 on initiative, strike, parry and dodge. Very sick, shaky, insecure. 40% chance will go back to drinking.

Second Week: -2% on all skills, -2 on initiative; -1 to strike, parry and dodge. Still shaky, insecure, craves alcohol. 20% chance will fall back to drinking. Roll for both weeks.

Third through Sixth Week: -2 on initiative. Still shaky, insecure, but feeling more confident. 13% chance will fall back to drinking. Roll for each week.

The next six months: Now it's a battle to stay dry; 15% chance the character will return to alcohol under extreme pressure. Roll for each pressure situation, such as near death (of self or friend), major failure, crucial situation relying heavily or entirely on the person, etc.

After those six months: There is still a possibility of returning to drink when under extreme pressure, as explained above; 5% in a crisis. If the ex-alcoholic should ever drink alcohol again, there is a 43% likelihood of becoming addicted again. Roll for each *drink*. Note: A character can attempt to fight alcoholism repeatedly, regardless of numerous failures.

THE EFFECTS OF DRUG ADDICTION

Drug addiction is generally more severe in its effects and initial withdrawal symptoms. However, once detoxified/dry, the person is less likely to return to drugs than an alcoholic. Most references to drug addiction refer to hard drugs, such as L.S.D., heroin, P.C.P., barbiturates (downers), amphetamines (speed), cocaine derivatives, and mood altering drugs.

Roll for effects and disposition while intoxicated

- 1-10 Quick temper, argumentative; +1 on initiative.
- 11-20 Totally passive, will *not* attack, confused, wants to be left alone. -5 to parry, dodge, and roll with punch or fall.
- 21-30 Extremely paranoid. Trusts no one, not even friends; +1 on initiative.
- 31-40 Disoriented. Has difficulty following movement; -4 to parry and dodge, -2 to strike.
- 41-50 Hallucinations. Totally oblivious to reality; -4 to parry and dodge, 50% chance of not recognizing friend or foe, or attacking a friend (thinking him an enemy), or not recognizing danger, or cringe in terror of battle phantoms.
- 51-60 Withdrawn, quiet; -6% on all skills.
- 61-70 Secure/self-assured only while high; -4% on all skills when not on drugs.
- 71-80 Depressed, pessimistic; -8% on all skills.
- 81-85 Reoccurring hallucinations when under severe pressure/combat. 43% chance of reoccurrence/flashback, same as hallucinations listed previously.
- 86-91 Hyper, agitated, always moving, distracted; -2 on initiative, -2% on all skills.
- 92-00 Super syndrome; believes his abilities are heightened by drugs; +1 to strike, parry and dodge; +6% on all skills when high. -1 to strike, parry and dodge; -12% on all skills when straight (not on a drug-high).

General notes concerning drugs:

- Takes 15 to 20 minutes to take effect.
- Effects last 45 minutes to two hours.
- Remains in system, even after the high is gone, for 48 hours.
- Addicts *need* a continual supply, taken at least once or twice a day (or more often, depending on the drug and desired effects).

Drug addiction can be cured, and requires a willingness to seek treatment and being slowly weaned off its dependency by

gradual substitutes. Total withdrawal, or going "cold turkey," is the sudden abstinence from any drugs.

Withdrawal Symptoms (cold turkey)

First Week: -35% on all skills, -8 on all combat skills, violently ill: nausea, vomiting, cramps, etc. Requires regular observation and facilities. 75% likelihood of taking the drug if it's available.

Second Week: -20% on all skills, -4 on all combat skills, very weak, shaky, nauseated. 50% chance of taking the drug if it's available.

Third Week: -10% on all skills, -2 to strike, parry and dodge. Weak and insecure, but feeling considerably better. 28% chance of taking the drug if available.

Fourth Week: Completely detoxified, only psychological addiction remains. 14% chance of taking the drug if made available. Suggest continued therapy/counseling.

The next six months: This is the battle to stay dry. 10% chance will return to drugs if under extreme pressure.

After those six months: There is little chance of turning to drugs, even if under pressure; 3% chance.

Note: A character can attempt to fight addiction repeatedly, despite numerous failures to do so.

Skill Descriptions

Skill List by Category

Communications

Cryptography
Laser
Optic Systems
Radio: Basic
Radio: Scramblers
Surveillance Systems
T.V./Video

Domestic

Cook
Dance
Fishing
Play Musical Instrument
Sewing
Sing

Electrical

Basic Electronics
Computer Repair
Electrical Engineer

Espionage

Detect Ambush
Detect Concealment
Disguise
Escape Artist
Forgery
Intelligence
Interrogation Techniques
Pick Locks
Pick Pockets
Sniper
Tracking
Counter-Tracking
Wilderness Survival

Mechanical

Aircraft Mechanics
Automotive Mechanics

Basic Mechanics
Locksmith
Mechanical Engineer
Weapons Engineer

Medical

Criminal Sciences & Forensics
Forensic Medicine
First Aid
Holistic Medicine
Paramedic
Medical Doctor
Pathology
Toxicology

Military

Demolitions
Demolitions Disposal
Military Etiquette
Strategy/Tactics

Physical

Hand to Hand: Basic
Hand to Hand: Expert
Hand to Hand: Martial Arts
Hand to Hand: Assassin
Acrobatics
Athletics (general)
Body Building & Weight Lifting
Boxing
Climbing
Gymnastics
Prowl
Running
Swimming
S.C.U.B.A.
Wrestling

Pilot Skills

Airplane
Automobile
Boat: Sail Type
Boat: Motor and Hydrofoils
Boat: Ships
Helicopter
Horsemanship
Hover Craft (ground)
Jet Aircraft
Jet Fighters
Jet Packs
Motorcycle
Truck
Tanks and APCs

Pilot Related Skills

Navigation
Read Sensory Equipment
Weapon Systems

Rogue Skills

Computer Hacking
Concealment
Palming
Pick Locks
Pick Pockets
Prowl
Streetwise
Streetwise - Drugs (special)

Science

Anthropology
Archaeology
Astronomy
Biology
Botany
Chemistry
Chemistry - Analytical
Mathematics: Basic
Mathematics: Advanced

Technical

Art
Computer Operation
Computer Programming
Language
Literacy
Lore — Demons and Monsters
Lore — Geomancy or Lines of Power
Lore — Nightbane
Lore — Nightlands
Lore — Religion
Lore — Vampires
Photography
Research
Writing

Weapon Proficiencies

W.P. Archery and Targeting
W.P. Battle Axe
W.P. Blunt
W.P. Chain
W.P. Knife
W.P. Polearm
W.P. Sword
W.P. Whip
W.P. Revolver
W.P. Automatic Pistol
W.P. Bolt-Action Rifle
W.P. Automatic and Semi-automatic Rifles
W.P. Sub-Machinegun
W.P. Heavy

Wilderness

Carpentry
Boat Building
Hunting
Identify Plants & Fruits
Land Navigation
Preserve Food
Skin and Prepare Animal Hides
Track Animals

Communications

Cryptography: Skill in recognizing, designing, and cracking secret codes and messages. The character must study the code for two hours to attempt to break it successfully. A failed roll means the individual must study the code for an additional two hours before he can try to break it again. The character may attempt to break the code sooner, after only 10 minutes of study, but suffers a penalty of -30%. **Base Skill:** 25% +5% per level of experience. **Requires:** Literacy.

Laser: This skill provides the character with an indepth knowledge of sophisticated laser communication systems and fiber optic communications. **Base Skill:** 30% +5% per level of experience. **Requires:** The radio: basic, electrical engineer, and computer operation skills.

Optic Systems: Provides expert training in the use of special optical enhancement equipment such as telescopic lens, laser targeting, thermo-imagers, passive light intensifiers, infrared and ultraviolet systems, polarization, light filters, optical scanners, and related devices. **Base Skill:** 30% +5% per level of experience. Adds a special one time bonus of +5% to T.V./video skill if both are selected.

Radio: Basic: This is the rudimentary knowledge of the operation and maintenance of field radios and walkie-talkies, wire laying, installation, radio procedure, communication security and visual signs/communications, as well as Morse code. It does not include repairs. **Base Skill:** 45% +5% per level of experience.

Radio: Scramblers: This is training in the use of electronic masking, scrambling and unscrambling equipment, and codes for the transmission of radio signals. **Base Skill:** 35% +5% per level of experience.

Surveillance Systems: This is the study and understanding of the operation, methods, and techniques in the use of surveillance systems. Includes motion detectors, simple and complex alarm systems, audio/visual recording and display equipment, recording methods, amplified sound systems, miniature listening devices (bugs, line tapping), and some optical enhancement systems (specifically as they relate to camera lenses).

Tailing, or following someone without their knowledge, is another form of surveillance. This also includes stake-out procedures. A failed surveillance roll indicates that the tail was spotted and the subject is aware of being followed/observed.

A failed roll in the use of surveillance equipment means that the equipment does not function as desired, impairing or preventing surveillance; i.e. bug does not transmit, recording garbled, film blurred or fails to record, etc.

A failed roll when hiding listening devices means the bug does not function and is easily discovered through the course of casual activity.

Base Skill: 30% +5% per level of experience. **Requires:** Electronics: basic or electrical engineering and computer operation and literacy (the latter two are needed only for complex, high-tech systems).

T.V/Video: Indepth training in the use of video and audio recording equipment, filming, editing, dubbing, title making, duplication, and transmission. Includes the use of field equipment, i.e. portable video camera, and studio equipment, i.e. editing and transmission, etc. **Base Skill:** 25% +4% per level of experience.

Domestic

Note: Characters can attain *professional* quality by selecting the same domestic skill twice. Add a one time bonus of +10% and note that the end result is of superior quality.

Cook: Skill in selecting, planning, and preparing meals. A cooking roll failure means that the cooked food is not properly prepared. It is edible but tastes bad (greasy, too spicy, sour, burnt, leaves a bad after-taste in mouth, etc.). **Base Skill:** 35% +5% per level of experience.

Dance: A practiced skill in the art of dancing. The character is especially smooth and graceful, a joy to dance with. Can learn new dance steps/moves much more quickly than somebody who can not dance. **Base Skill:** 30% +5% per level of experience.

Fishing: The fundamental methods and enjoyment of the relaxing sport of fishing. Areas of knowledge include the use of lures, bait, poles, hooks, lines, and the cleaning and preparation of fish for eating. Also includes a basic knowledge of freshwater fish, their habits and taste. **Base Skill:** 40% +5% per level of experience.

Play Musical Instrument: The individual has learned to play a particular musical instrument with a fair amount of skill. The sound is generally pleasant (except when a bad roll is made). Note that each specific instrument requires the selection of this skill. For example: a character who can play the guitar, violin, and harmonica must select the *play musical instrument* skill three different times. **Base Skill:** 35% +5% per level of experience.

Sewing: The practiced skill with the needle and thread to mend clothing, do minor alterations, and layout, cut and sew simple patterns. This is not a tailoring ability, but can become tailoring if the player selects this skill twice. **Base Skill:** 40% +5% per level of experience.

Sing: The simple ability to read music and carry a pleasant tune. **Base Skill:** 35% +5% per level of experience.

Electrical

Basic Electronics: This is a rudimentary understanding of the principles of electricity, simple circuits, wiring, and so on. This person can do basic wiring, repair appliances, and read schematics. **Base Skill:** 30% +5% per level of experience.

Computer Repair: Knowledge of the internal electronics of computers and related devices (terminals, printers, modems, etc.). The character can attempt to repair or sabotage computers. Note that figuring out the repair or sabotage procedure counts as one roll, and the actual repair is a second roll. A failed roll means the repair is faulty and does not work (try again). No computer operation or programming skills are included nor required to fix computers. Many computer repair personnel don't even know how to turn the computer on! **Base Skill:** 25% +5% per level of experience.

Electrical Engineer: Knowledge of electricity. Characters can diagnose and locate electrical problems, repair complex electrical devices, wire entire buildings or vehicles, and build electrical equipment. The character can also attempt to bypass security systems, alarms, and surveillance systems, but at a penalty of -20% for simple systems and -50% for complex systems (reduce these penalties by half if the character also has the *sur-*

veillance systems skill). **Base Skill:** 30% +5% per level of experience. **Requires:** Advanced mathematics skill and literacy. **Note:** There is a -30% penalty when working on *alien* or extremely unfamiliar electronics.

Espionage

Detect Ambush: Training which develops an eye for spotting location and terrain suitable for ambushes and being ambushed. It also provides a rudimentary knowledge of guerrilla tactics used by the enemy. **Base Skill:** 30% +5% per level of experience.

Detect Concealment: This is a skill which enables the individual to spot and recognize camouflage, concealed structures/building and vehicles, as well as the ability to construct unobtrusive shelters, use camouflage and blend into the environment. **Base Skill:** 25% +5% per level of experience.

Disguise: The character knows how to apply make-up, wigs, skin putty, dyes, and other special effects in order to alter his appearance or that of somebody else. **Base Skill:** 25% +5% per level of experience.

Escape Artist: The methods, principles, and tricks of escape artists. Includes muscle control (tensing and relaxing muscles), flexing and popping joints, knowledge of knots, and the ability to conceal small objects on the person. The character can try slipping out of handcuffs, ropes, straitjacket, etc. **Note:** Picking locks is a separate and distinct skill. **Base Skill:** 30% +5% per level of experience.

Forgery: The techniques of making false copies of official documents, signatures, passports, I.D.s, and other printed material. The forger must have an original or photocopy to work from in order to make an accurate copy. Skilled forgers can recognize other counterfeits at -10%. **Base Skill:** 20% +5% per level of experience.

Intelligence: This is the specific training in the practices and principles of recognizing and analyzing sources of information about the enemy, observation techniques, counterintelligence measures and proper procedure. This includes the practical assessment of sights and sounds, estimation of ranges, what to report, handling prisoners of war, and handling captured documents and equipment (tagging and reporting to group leaders or proper authorities). This means the character will be able to accurately estimate ranges, the number of enemies, direction, purpose, and assess the importance of specific information.

Further intelligence training includes a working knowledge of indigenous guerrilla warfare, enemy practices, appearance, and current activities. This enables the intelligence officer to recognize suspicious activity as guerrilla actions and identify guerrilla operatives. **For Example:** A particular booby trap, or weapon or mode of operation may be indicative of guerrilla activity in the area. It may be up to the character to confirm the existence of the enemy and their strengths, number, and location.

Another area of training made available to intelligence is the identification of enemy troops, officers, and foreign advisors. This means the person learns the many distinguishing ranks and marks that identify specific military units, special forces, groups, and leaders of the enemy. Such identification can pinpoint and confirm enemy operations, goals, and movement, as well as confirm outside intervention/aid.

Note: A failed roll in any of the areas of intelligence means that evidence is inconclusive, or that the character has incorrectly assessed the information/situation and is uncertain. A failed roll involving individual clues may mean the person has dismissed it entirely as being meaningless (game masters use your discretion). **Base Skill:** 32% +4% per level of experience.

Interrogation Techniques (NEW): This skill is learned by policemen, intelligence officers, etc. The character knows the techniques to get information from (typically unwilling) subjects. This includes such old methods as “good cop/bad cop” (one interrogator is threatening and intimidating, the other is sympathetic and friendly), deceiving and misleading the subject into giving away information, and similar methods. The character can also judge if the subject is lying (the game master might assess bonuses and penalties depending on how good a liar the subject is). This skill also includes some basic knowledge on methods of torture, from basic tactics like depriving the subject of sleep, to the old “medieval” instruments and new, sophisticated techniques like sensory deprivation, partial electrocution, and drugs. **Note:** Only evil characters will engage in torture routinely. **Base Skill:** 40% +5% per level of experience.

Pick Locks: The character knows the methods and tools for picking/opening key and basic tumbler type locks. This does not include sophisticated computer or electronic locks.

It takes 1D6 melee rounds for each attempt to pick a lock. A failed roll means the lock holds; try again. **Base Skill:** 30% +5% per level of experience.

Pick Pockets: An ability to remove items from a person without their being aware of it. If a pick pocket attempt fails, the item has NOT been removed and there is a 67% likelihood of the intended victim recognizing the intent of the action. **Base Skill:** 25% +5% per level of experience.

Sniper: This skill represents special training in long-range rifle firing and marksmanship. Only rifles that can be made to fire a single round or blast can be used for sniping (no automatic/multi-firing rifles). Adds a bonus of +2 to strike on an *aimed* shot.

Tracking: Visual tracking is the identification of tracks, and following the path of men or animals by the signs they leave on the ground and vegetation. Tracking is a precise art, requiring much practice. The skill includes the evaluation of tracks, indicating whether the person being tracked is loaded down with equipment, running, moving slowly (by measuring the space between steps), and so on. By this means, the tracker can estimate the person’s rate of movement, apparent direction, the number of persons in the party, and whether the person knows he is being followed. Other methods of tracking require recognizing other telltale signs, such as blood and other stains, broken and displaced vegetation, overturned rocks, litter (such as cigarette butts, ration cans, candy wrappers, soiled bandages and camp fire remains), and even odors carried by the wind.

Tracking also includes the recognizing of dangerous animals by their tracks, habits and feces. Likewise, tire tracks of vehicles can reveal much, such as size and type of the vehicle, the weight of its load, etc.

Counter-Tracking techniques are also known, such as covering one’s trail, misdirection, parallel trails, avoiding obvious pitfalls like littering and others.

A **failed roll** means that the signs are inconclusive, vague or misleading. Additional signs must be found to verify or clarify (roll again). Three consecutive failed rolls means the tracker has completely lost the trail. Roll once every 40 yards/meters when *following* a trail. Persons attempting to follow a skilled tracker are -25% when following his trail, if he is deliberately trying to conceal that trail (however, his rate of travel is reduced by half). **Base Skill:** 25% +5% per level of experience.

Wilderness Survival: Techniques for getting water, food, shelter, and help when stranded in wild forests, deserts, or mountains. Characters without this skill will not be able to stay healthy for more than a few days in the wilderness once their supplies run out. **Base Skill:** 30% +5% per level of experience.

Mechanical

Aircraft Mechanics: The understanding of aerodynamics and the training to repair, rebuild, modify, and redesign conventional aircraft; including single engines, twin engine airplanes, jets, helicopters and hovercraft. **Base Skill:** 25% +5% per level of experience.

Automotive Mechanics: The ability to repair, rebuild, modify, and redesign conventional vehicles with internal combustion (gas) engines. It also includes body work, turbine engines, methanol, ethanol and diesel truck engines. When working on hover jet systems for ground vehicles is possible, but with a -20% penalty. Working on reactor engines there is a -40% penalty. **Base Skill:** 25% +5% per level of experience.

Basic Mechanics: A general familiarity and understanding of basic mechanics. This character can fix a toaster, repair a bicycle, replace a belt on a motor, repair or replace a switch, handle or a knob, replace a spark plug, change oil, assist in automobile repairs, maintain machinery, read a schematic and similar fundamental tasks. **Base Skill:** 30% +5% per level of experience.

Locksmith: The study of lock designs and the ability to repair, build, modify and *open* locks. The methods, techniques, and tools of lock picking include the old-style key and tumbler, combination, and modern electrical locking systems. **Time requirements:** 1D4 melees to open an antiquated key type lock or simple tumbler/combination type, 1D4 minutes to open an elaborate tumbler type, 2D4 minutes to open a simple electronic lock (usually by patching in a bypass system), and 1D4 hours to break a complex, state-of-the-art electronic lock system such as those used in high security and restricted areas. Super high-tech systems, such as those used by the military and government, will require 3D4 hours and have a skill penalty of -20%.

If an unsuccessful skill roll is made, the lock is not opened and the process must be repeated. If an attempt to open an electronic lock fails, roll again. A second failed roll means that the lock is irreparably damaged and can *not* be opened! **Base Skill:** 25% +5% per level of experience. **Requires:** At least basic electronics skill (-5% penalty when working on complex or high-tech locks) or electrical engineer (+5% bonus).

Mechanical Engineer: Training, understanding, and knowledge of how machinery is designed, operated, built, and maintained. Characters can attempt to redesign, modify, repair, construct, or sabotage mechanical devices (includes nuclear reactor driven turbines and atomic engines). The player must first roll to see if his character can figure out how to operate/ana-

lyze/design a machine. When a successful diagnostic roll has been made, roll again to determine when the character can fix/change/build the mechanism.

Base Skill: 25% +5% per level of experience. **Special Bonus:** Add a one time bonus of 5% to the locksmith and surveillance systems skills if mechanical engineering is also known. There is a -30% penalty when working on *alien* or extremely unfamiliar mechanics. **Requires:** Basic or advanced mathematics, at least basic electronics, and literacy.

Weapons Engineer: This skill is usually reserved for military personnel. The character can maintain, repair, modify, mount, and figure out most weapon systems. He can repair an assault rifle and install a missile system into a vehicle. The engineer can also add and repair body armor and is an expert welder. **Base Skill:** 25% +5% per level of experience. **Requires:** Mechanical engineering and basic electronics.

Medical

Criminal Sciences & Forensics: Basic knowledge of police skills, including basic criminal law, fingerprinting, ballistics (matching bullets to weapons and angles of impact), and general investigative techniques.

Forensic medicine is the method and techniques which enable the character to find evidence regarding the cause of death, time of death, and other details when examining a corpse. **Base Skill:** 35% +5% per level of experience. **Requires:** Biology, chemistry, chemistry analytical, advanced mathematics, and literacy.

First Aid: Rudimentary medical treatment which includes how to bandage wounds, stop bleeding, administer CPR/artificial respiration, and use antiseptics and common anti-inflammatory drugs and painkillers. **Base Skill:** 45% +5% per level of experience.

Holistic Medicine: Training in the recognition, preparation, and application of natural medicines usually made from plants and their parts (roots, leaves, fruit). The holistic doctor is basically a natural pharmacist and naturalist who creates drugs from vegetation and studies common ailments. He can find and use plants to create salves, balms, ointments, and lotions to soothe burns, boils, rashes, and insect bites, reduce swelling, as well as create local anesthetics, and to heal wounds faster (twice as quick as normal). Potions and tonics are created to settle upset stomachs, induce drowsiness, or hallucinations. The individual can also make alcohol and poison (hemlock and mandrake, for example).

The student of herbology also has a good knowledge of plant lore and when and where to find healing plants, edible fruit, berries, roots, and bark, as well as how to use and/or avoid dangerous flora. The character can also preserve foods and knows how to set and mend bones, bandage cuts, and suture cuts.

Note: Plants are seasonal and the right root or leaf may not be readily available in certain times of the year/season, or may be found exclusively in remote regions. Game masters should use a certain amount of common sense and drama with this skill. **Base Skill:** 20% +5% per level of experience. A failed roll means the treatment or concoction did not work.

Paramedic: An advanced form of emergency medical treatment which includes *all* first aid techniques, the setting of broken bones, suturing of wounds, use of oxygen and emergency medical equipment, administering of drugs, knowledge of how to move a critically injured person, and other life saving techniques.

A failed roll means the patient has not responded to treatment or that the treatment has been improperly administered. **Note:** For serious injury or coma, roll three times, consecutively, on percentile dice. A roll of two successful out of three means the wound has been properly treated or that the patient's condition has been stabilized. Failure means the patient's condition is unchanged. Another character can immediately attempt to apply medical aid or the same player can try again, but only after the character has spent six minutes for reexamining and/or concentration on the problem. **Base Skill:** 40% +5% per level of experience.

Medical Doctor: The medical doctor is a trained surgeon and has a doctorate in the medical sciences.

Areas of training include: clinical skills, medical discipline, code of ethics, physiology (muscle, respiratory, blood, body fluids), pathology (diseases, their structure and function), rudimentary pharmacology (use, reaction, and interaction of drugs), laboratory skills, and techniques and methods of data collection. The medical doctor (M.D.) is also a trained surgeon. **Base Skill:** 60/50% +5% per level of experience. The first percentage number is the doctor's ability to accurately diagnose the problem. The second percentage number is the doctor's skill at successfully treating the problem. **Requires:** Biology, pathology, chemistry, basic or advanced mathematics and literacy.

Pathology: This branch of medicine deals with the nature of diseases, their cause, and symptoms, and the functional and structural changes caused by disease. Training includes anatomy, physiology, cell biology, manifestation of disease, tissue injury and repair, abnormal cell structure, metabolism, diagnosis of human disease, tissue culture methods and applications, analysis of drugs in biological samples and laboratory research, investigative methods, and use of instruments, tools and equipment. **Base Skill:** 40% +5% per level of experience. **Requires:** Biology, chemistry, and literacy skills.

Toxicology (NEW): This is a specialty in medicine that deals with poisons, venoms and toxins, their manufacture, composition and antidotes. This skill is useful for both healers and assassins. A successful skill roll will help determine if poisons have been used on somebody and even the general type of poison/toxin used (a definite answer may require an autopsy and the forensics skill). **Base Skill:** 40%+5% per level of experience. **Requires:** Biology, chemistry, and literacy.

Military

Demolitions: Demolitions provides the person with an advanced knowledge in the use and workings of explosives and detonation devices for the purpose of blowing up bridges, buildings, and sabotage. This includes *all* types of explosives, such as mines, dynamite, plastics, nitro, blasting caps, etc. It also includes a basic understanding of the strategic placement of mines and booby traps. This will increase the character's awareness of suspicious rope, string, and wire. **Base skill:** 60% +3% per level of experience. A failed roll means a dud; no explosion.

Demolitions Disposal: This skill enables the character to safely defuse unexploded mines, bombs, explosive booby traps, dud artillery rounds, dud explosive charges, or any other explosive device. **Base Skill:** 60% +3% per level of experience.

Military Etiquette (NEW): This skill grants a basic understanding of the way the military works. It includes basic rules of behavior (when to salute, how to address superiors/subalterns, etc.) as well as how to deal with military bureaucracy, who to contact to get things done, and other useful information. A character with this skill will have a good idea of how matters are handled in military bases and facilities, from the setting of watches to where to get live ammo (actually getting the ammo is a different matter altogether, of course). **Base Skill:** 35% +5% per level of experience.

Strategy/Tactics (NEW): This is part of the training given to combat soldiers and officers, and includes a basic understanding of the "military doctrine" of the army in question, including preferred methods of fighting (on both a small scale engagement or a full battle), "do's and don'ts," guerilla warfare, and other basic military methods. A successful strategy/tactics roll will reveal some hints as to the best way to approach a potential combat or military situation, like recognizing potential attack/retreat areas, getting good fields of fire, recognizing a good location for a crossfire or booby trap, etc. **Base Skill:** 30% +5% per level of experience.

Physical

Special Note: One of the unique aspects of this RPG is that the player can build and increase his or her character's physical attributes (P.S., P.P., P.E., Spd., S.D.C.) by selecting physical skills that will build and develop the body's muscles and endurance. ALL attribute and skill bonuses are accumulative. However, a specific physical skill may only be chosen once, including hand to hand skills.

There are four major kinds of fighting techniques available to the characters. Boxing and wrestling adds to the techniques and power of a specific hand to hand training. Characters without combat training have one hand to hand attack per melee at levels one and two, but get a second attack at level three and a third attack at level nine.

Hand to Hand Basic: Provides elementary fighting techniques and methods of attack and self-defense as taught in military basic training or in self-defense classes. *See the combat section for listing of specific abilities.*

Hand to Hand Expert: An advanced form of self-defense and unarmed combat usually taught to commandos. *See the combat section for listing of specific abilities.*

Hand to Hand Martial Arts: This is some form of oriental fighting skill (karate, kung-fu, etc.) that teaches advanced hand to hand combat. *See the combat section for listing of specific abilities.*

Hand to Hand Assassin: This is an advanced form of combat with an emphasis on immobilizing or killing one's opponent quickly. *See the combat section for listing of specific abilities.*

Acrobatics: Aerial feats of agility and strength, such as walking a tightrope, high wire, trapeze, and stunts performed above ground. Other physical abilities include rolls, somersaults, leaps, and falls. Provides all of the following:



Automatic kick attack at first level; 1D8 damage.
 60% +5% per level — Sense of balance
 60% +3% per level — Walk tightrope or high wire
 80% +2% per level — Climb rope
 60% +5% per level — Back flip
 40% base climb ability or adds a +15% to climb skill.
 30% base prowl ability or adds a +5% to prowl skill.
 +2 bonus to roll with punch or fall
 +1 to P.S.
 +1 to P.P.
 +1 to P.E.
 +1D6 to S.D.C.

Athletics (general): Training in, and enjoyment of, vigorous exertion for competitive sports, exercises, and contests of strength, endurance, and agility. Provides the following bonuses:

+1 to parry and dodge
 +1 to roll with punch or fall
 +1 to P.S.
 +1D6 to Spd.
 +1D8 to S.D.C.

Body Building & Weight Lifting: The building of muscle tone and body strength through weight lifting and exercise. Provides the following:

+2 to P.S.
 +10 on S.D.C.

Boxing: Classic art of fighting with fists. Training helps build the body and reflexes. Skilled boxers will *automatically* knock-out opponents on a roll of a natural twenty. The victim of a

knockout will remain unconscious for 1D6 melees. Unlike normal knockout/stun, the player does not have to announce that he is trying to knock out his opponent before making a roll to strike.

The following bonuses are provided:

+One additional attack per melee.
 +2 to parry and dodge
 +1 one to roll with punch or fall
 +2 P.S.
 +3D6 on S.D.C.

Climbing: Knowledge of the tools and techniques for climbing up sheer surfaces. Players should roll once for every 20 feet (6 m) of a vertical climb. If the roll fails, it means he is losing his grip, however, every “skilled” climber gets a chance to regain his grip, roll again. Two consecutive failed rolls means the character falls. **Base Skill:** 40% + 5% per level of experience.

Rapelling is a specialized, rope climbing skill used in descending from helicopters, scaling walls and cliff facings. For game purposes, rapelling will include ascending and descending climbs. **Base Skill in rapelling:** 30% +5% per level of experience.

Gymnastics: Learning to do falls, rolls, tumbles, cartwheels, somersaults and to work the parallel bars and rings. This sport builds great upper body strength, grace, and balance. Provides all of the following:

Automatic kick attack at first level; 2D4 damage.
 50% +5% per level — Sense of balance
 60% +3% per level — Work parallel bars & rings
 70% +2% per level — Climb rope

70% +5% per level — Back flip
25% base climb ability or adds a +7% to climb skill.
30% base prowl ability or adds a +5% to prowl skill.
+2 bonus to roll with punch or fall
+2 P.S.
+1 to P.P.
+2 to P.E.
+2D6 to S.D.C.

Prowl: This skill helps the character to move with stealth; quietly, slowly, and carefully. Techniques include balance and footing, short steps and pacing, rifle positioning, prone positions for low visibility, and crawling. A failed prowl roll means that the character has been seen or heard. If the prowl roll is successful, then the character is not seen or heard and may make a sneak attack. **Base Skill:** 25% +5% per level of experience.

Running: A routine of running and exercise to build speed and endurance. Provides the following:

+1 to P.E.
4D4 to Spd
1D6 to S.D.C.

Swimming: The rudimentary skill of keeping afloat, dives, swimming and lifesaving techniques. The percentile number indicates the overall quality of form as well as skill of execution. A character can swim a distance equal to 3x his P.S. in yards/meters per melee. This pace can be maintained for a total of minutes equal to his P.E./endurance. **Base Skill:** 50% +5% per level of experience.

S.C.U.B.A.: The letters S.C.U.B.A. stand for Self-Contained Underwater Breathing Apparatus. Individuals learn the methods and equipment needed for skin diving and underwater swimming. A character can swim a distance equal to 2x his P.S. in yards/meters per melee. This pace can be maintained for a total of minutes equal to his P.E./Endurance. **Base Skill:** 50% +5% per level of experience. **Note:** The maximum safe depth without getting the bends is about 120 feet (36.5 m). Deeper depths are possible with depressurization, special suits and submarines. Swimming is required to S.C.U.B.A.

Wrestling: As taught in old high schools and colleges, wrestling is more of a sport than a combat skill, but it does provide some useful combat moves. Provides the following:

Body block/tackle does 1D4 damage and the opponent must dodge or parry to avoid being knocked down (lose one melee attack if knocked down).

Pin/incapacitate on a roll of 18, 19, or 20.

Crush/squeeze does 1D4 damage per squeeze attack.

+1 to roll with punch or fall

+2 to P.S.

+1 to P.E.

+4D6 to S.D.C.

Pilot Skills (Ground, Air, Water)

Airplane: Includes old propeller, single and twin engine types. **Base Skill:** 50% +4% per level of experience.

Automobile: Manual and automatic transmissions; includes dune buggies, jeeps, and small trucks. **Base Skill:** 60% +2% per level of experience.

Boat: Sail Type: Small sailing and medium sized sailing yachts, and fishing boats. **Base Skill:** 60% +5% per level of experience.

Boat: Motor and Hydrofoils: These include all types of small motor driven boats and yachts. **Base Skill:** 55% +5% per level of experience.

Boat: Ships: This includes all large sailing and motor driven seafaring vessels. **Base Skill:** Sailing ships 45% +5% per level of experience. Motor driven ships 44% +4% per level of experience.

Helicopter: The specialized skill required in flying all types of helicopters, including combat 'copters (but must have the weapons systems skill to operate weapons on a combat helicopter). **Base Skill:** 35% +5% per level of experience.

Horsemanship: In certain places, the horse is a popular means of transportation. The skill includes the basic principles of riding, the care and feeding of the animal, recognizing breed and quality, charging, and jumps. The percentile number is used whenever the character tries to determine breed and quality, and for special jumps or maneuvers. **Base Skill:** 40% +4% per level of experience.

Special Bonuses: The horseman has the advantage of height, leverage, and velocity when attacking on a horse. This provides the following bonuses when charging on horseback: +1 to parry and dodge, +4 damage. Note that a person cannot shoot a projectile weapon of any kind (bow and arrow or gun) with any degree of accuracy. An aimed shot is impossible on a moving animal! Bursts are possible if the horse is moving quickly, but not at a full gallop. At full gallop, the shooter can fire only as *wild*.

Note: At the G.M.'s discretion, this skill can also apply to riding supernatural animals/monsters (not applicable to intelligent creatures) at a **Base Skill:** 24% +4% per level of experience.

Hover Craft (ground): The knowledge needed in piloting hover cycles and other hover vehicles used for ground transport. These vehicles can be tricky, because they utilize several air jets and directional thrusters that pushes the craft along, above the ground, on a cushion of air. The vehicles can usually attain great speeds and are capable of driving over incredibly rugged terrains and make sensational jumps over craters and ravines. **Base Skill:** 50% +5% per level of experience.

Jet Aircraft: Includes large and small commercial transport jets. **Base Skill:** 40% +4% per level of experience.

Jet Fighters: Training includes flying, maneuvering, aerial combat strategies, and typical fighter jet weapon systems. **Base Skill:** 40% +4% per level of experience.

Jet Packs: This is the piloting skill of backpack like units that strap to the back of an individual to carry him airborne. The typical jet pack is a one person unit capable of hovering above the ground and flying at an average altitude of 300 feet (91.5 m). **Base Skill:** 42% +4% per level of experience.

Motorcycle: This skill includes the piloting of all two and three wheeled vehicles such as motorcycles of all types, dirt bikes, and mopeds. **Base Skill:** 60% +4% per level of experience.

Truck: This piloting skill specifically applies to large cargo and transport vehicles like eight to sixteen wheeled commercial trucks and multi-ton transports. **Base Skill:** 40%+4% per level of experience.

Tanks and APCs: Military vehicles often have unconventional controls and handle differently than conventional vehicles, especially the many ton, armored, combat vehicles such as tanks

and armored personnel carriers (APC). Thus, special training is required to pilot them. **Base Skill:** 36% +4% per level of experience.

Pilot Related Skills

Navigation: Training in map reading, star charts, course computation, following landmarks, and use of navigational equipment. Includes land, air, and water navigation, as well as piloting by instruments alone. A failed roll means the pilot is off course. Roll 2D6×100 for most aircraft, 4D6×100 for jets, and 2D6×10 for ground vehicles to determine how many miles/kilometers they are off course. Roll for every hour that one is off course. **Base Skill:** 40% +5% per level of experience. **Requires:** Basic math read sensory equipment, and at least minimal literacy.

Read Sensory Equipment: Individuals with this training can operate, maintain, understand, and “read” or interpret sensory data from all types of conventional sensor devices. These devices include radar, sonar, motion detectors, surveillance equipment, optical enhancements, instrument panels, and so on. Note that characters without this skill cannot understand nor operate aircraft, radar, or detection/surveillance equipment. **Base Skill:** 30% +5% per level of experience.

Weapon Systems: This is the complete understanding of weapon units and systems incorporated in military vehicles. It includes machineguns, missile and grenade launchers, cannons, and other heavy weapons systems. Adds a special bonus of +1 to strike when using these type of weapons; this does not include hand-held weapons (see *Weapon Proficiencies*). **Base Skill:** 40% +5% per level of experience.

Rogue Skills

Computer Hacking: This is a computer skill similar to computer programming, however, the emphasis of the skill is breaking computer access codes to gain illegal access to other computer systems and steal or sabotage its data. The character is an expert in tracing computer data, bypassing defense systems, and breaking (“hacking”) codes; add a one time bonus of +5% to the cryptography, surveillance, and locksmith skills if the character is a hacker. **Base Skill:** 15% +5% per level of experience. **Requires:** The ability to read and write, computer operation, computer programming, and at least basic mathematics.

Concealment: The practiced ability to hide small items on one’s body or in hand, usually by continually moving it around from hand to hand or place to place unnoticed. Objects must be no larger than 14 inches in height and length, and six inches in width. The weight must also be 10 pounds or less (4.5 kg). The smaller and lighter the object, such as a knife, gem, key, credit card, etc., the easier it is to conceal (add a bonus of +5%). Larger items such as a book, scroll, club, statue, or similarly large or heavy object are more difficult to conceal on one’s person for obvious reasons. **Base Skill:** 20% +4% per level of experience.

Palming: Simply the ability to pick up and seemingly make a small object, such as a coin, key or credit card, disappear by concealing it in one’s hand. Adds a bonus of +5% to the pick pocket skill.

Base Skill: 20% +5% per level of experience.

Pick Locks: The character knows the methods and tools for picking/opening key and basic tumbler type locks. This does not include sophisticated computer or electronic locks.

It takes 1D6 melee rounds for each attempt to pick a lock. A failed roll means the lock holds; try again. **Base Skill:** 30% +5% per level of experience.

Pick Pockets: An ability to remove items from a person without their being aware of it. If a pick pocket attempt fails, the item has NOT been removed and there is a 67% likelihood of the intended victim recognizing the intent of the action. **Base Skill:** 25% +5% per level of experience.

Prowl: This skill helps the character to move with stealth; quietly, slowly, and carefully. Techniques include balance and footing, short steps and pacing, rifle positioning, prone positions for low visibility, and crawling. A failed prowl roll means that the character has been seen or heard. If the prowl roll is successful, then the character is not seen or heard and may make a sneak attack. **Base Skill:** 25% +5% per level of experience.



Streetwise: This skill instills an understanding of the darker side of city life and the scoundrels who roam those streets. The streetwise character will be able to recognize gang members by their actions and philosophies, gang colors (emblems and clothing that denote membership to a particular organization), gang symbols and mannerisms, and dangerous locations and gangland haunts. The individual will also recognize a potential brawl situation, assess a gang member’s rank/power in the organization, and know some of the hangouts, modes of operation, rituals, ethics, and perhaps even notorious gang leaders of the more infa-

mous street gangs. This skill also includes the ability to recognize and locate black market dealers/organizations, illegal clinics, drugs and arms dealers, and similar criminal outfits. **Base Skill:** 20% +4% per level of experience.

Streetwise — Drugs (Special): The following additional street knowledge can be included as part of the regular streetwise skill or used as an additional rogue skill; G.M.'s choice. If used as a separate skill, the **Base Skill** proficiency is 25%+5% per level of experience.

The streetwise: drug skill gives the character the ability to recognize characters addicted to drugs, street corner pushers, big time dealers, drug smugglers, DEA agents, and undercover agents looking to bust dealers. Similarly, the character has a good idea what drugs cost, how to use them, and where to buy them (even if he doesn't use them himself). The character also knows most of the "street names" of common drugs, recognizes the drug when he sees it and knows the general effects and dangers it represents. He can also recognize the symptoms in others and can guess what drug a user may be high on with reasonable accuracy (roll under skill ability).

Science

Anthropology: This is the behavioral study of man and other intelligent life forms and their environments. Studies include societies, customs and beliefs, religions, political structure, as well as rudimentary history and archaeological background. It is important to note that anthropology is more concerned with the study of modern races and societies than it is with ancient ones. This is especially important when dealing with other races and cultures in the present time, to avoid accidentally breaking taboos or codes of behavior. It will also tell the anthropologist whether he may be dealing with a dangerous people (hate humans, fear technology or magic, are cannibals, worship demons, etc).

The skill can also be used in the examination of items/artifacts and ruins to identify the probable people/race, purpose, and technological level. The character can identify the period in which the item was used (contemporary or ancient), but is not skilled enough to tell whether an item is an authentic artifact or a forgery. **Base Skill:** 20% +5% per level of experience.

Archaeology: This is the scientific study of relics of ancient civilizations by excavation and analysis of artifacts. Studies include proper excavation (digs) techniques, preservation, restoration, and dating methods (including carbon dating), as well as a rudimentary history and anthropology background. **Base Skill:** 20% +5% per level of experience.

Astronomy: The study of the stars and other celestial bodies, their movements, positions, cycles, alignments, and interrelations with the earth and each other. This knowledge can also be used to determine direction, approximate distances, identify seasons, and tell the time of day. **Base Skill:** 25% +5% per level of experience.

Biology: Basic understanding of cells, anatomy, physiology, evolution, and genetics. The character will know how to use a microscope, cultivate bacteria, and how to classify new organisms. **Base Skill:** 30% +5% per level of experience.

Botany: Plants, their categories and functions, are studied extensively. Characters will know the basics of cross-fertilization

and germinating, as well as growing experimental plants. **Base Skill:** 25% +5% per level of experience.

Chemistry: The basic understanding of chemical principles and formulae. Characters know enough chemical laboratory procedures for analyzing and synthesizing chemical compounds in order to be competent assistants. **Base Skill:** 30% +5% per level of experience.

Chemistry - Analytical: Training in chemical engineering theories useful in the analysis of compounds and their practical applications. Characters will be highly skilled in the use of laboratory equipment and can analyze and synthesize chemicals. **Base Skill:** 25% +5% per level of experience. **Requires:** Chemistry, advanced mathematics, and literacy. Computer operation is highly suggested but not required.

Mathematics - Basic: Knowledge of basic math, including the ability to count, addition, subtraction, multiplication, division, and fractions. **Base Skill:** 45% +5% per level of experience.

Mathematics - Advanced: Knowledge of all basic and advanced mathematics, including algebra, geometry, trigonometry, calculus, and techniques for advanced mathematical formulae. **Base Skill:** 45% +5% per level of experience.

Note: Literacy and Computer skills are found under **Technical** skills and computer hacking is found under **Rogue Skills**.

Technical

Art: The ability to draw or paint or sculpt or do craft-work. Scholastic art training indicates a professional quality, while a secondary skill indicates a talented amateur. **Base Skill:** 35% +5% per level of experience.

Computer Operation: A knowledge of how computers work, along with the skills to operate peripherals like keyboards, printers, and modems. Characters can follow computer directions, enter and retrieve information, and similar basic computer operations. However, this does NOT include programming or hacking. **Base Skill:** 40% +5% per level of experience. **Requires:** Literacy.

Computer Programming: Advance computer knowledge that includes designing, programming, debugging, and testing computer programs and software. Hacking is possible, but at a penalty of -40% unless the character also has the computer hacking skill (see **Rogue Skills**). **Base Skill:** 30% +5% per level of experience. **Requires:** Computer operation and literacy.

Language: Characters with a language skill can understand and speak in a language other than his own native tongue. Language is one of the few skills that can be selected repeatedly in order to select several different languages. Each selection gives the character knowledge of a different language and costs one skill selection each time. **Base Skill:** 50% +5% per level of experience.

Literacy: By the end of the 20th century, literacy has decreased even in industrialized nations, to the point that the U.S. enjoyed less than a 90% literacy rate among the adult population. Characters must thus pick up literacy as a skill to determine that they can read beyond the most basic levels.

Like the language skill, the character may be able to read and write several different languages, but each language counts as a

separate skill selection. **Base Skill:** 30% +5% per level of experience.

Lore (A General Description)

Lore is a study and knowledge of historical and contemporary beliefs, myths, legends, folk-tales, stories and unorthodox theories regarding the supernatural or the unexplained. All lore skills will focus, in depth, on a particular area of interest and includes an historical and scientific viewpoint, as well as the less orthodox opinions. The skill percentage is used to indicate the degree of current knowledge and to recognize a subject's/item's relationship (if any) to any existing beliefs/myths or occurrences.

Lore — Demons and Monsters: This is a study of demonic entities and monster lore throughout the ages and around the world. It includes ancient and primitive cultures' belief in demons, possession, reputed demon places of habitation, appearances, habits, weaknesses, strengths and similar data. This knowledge also includes unusual creatures or monsters, past and present, including the Loch Ness Monster, giants, bigfoot/yeti, sea serpents, and other unusual creatures, their habitats, characteristics and so on. As a skill, it can help the character to recognize what may be a particular type of demon or monster by description, drawings, photos, footprints, legends, ritual, or action. **Nightbane Note:** In the world of Nightbane, this skill will NOT be very useful in studying or understanding the Nightbane themselves, although it may help identify some of the servants of the Nightlords. The Nightbane's incredible variety has given rise to so many legends that only someone who is aware of this mysterious race could hope to make sense of them. When dealing with Nightbane, HALVE the effective skill level. **Base Skill:** 35% +5% per level of experience.

Lore — Geomancy or Lines of Power: A study of ley lines, burial mounds, places of power, megaliths, and geomancy beliefs, past and present. Geomancy and ley lines are the belief that certain places on earth are polarized with an unknown energy or forces that can heal, cause paranormal phenomena, attract supernatural forces, or open dimensional gateways. The study includes "known" locations of such places, such as Stonehenge and the Bermuda Triangle, as well as the many theories behind them and the legacy of legends, mysteries, disappearances and dangers linked to each. The skill will provide the character with insight about the areas and enable him/her to recognize specific, known places of power, as well as recognize unknown megalithic markers of these revered or feared places. **Base Skill:** 30% +5% per level of experience.

Lore — Nightbane (NEW): This is a comprehensive study of the Nightbane species, their powers, limitations, and the myths and beliefs associated with them. Very few non-Nightbane have the crucial pieces of evidence that would allow them to have this skill, and those fortunate few usually gained the knowledge from a Nightbane who was willing (or forced) to pass the knowledge on. **Base Skill:** 30% +5% per level of experience.

Lore — Nightlands (NEW): The study of the shadowy parallel dimension ruled by the Ba'al. This skill includes knowledge about the inhabitants of the Nightlands, including the Nightlords, Doppelgangers, Hunters and Hounds, and others. This skill is most often found in the hands of mystics and psychics who have seen the Nightlands with their own eyes, but a number of occultists have also unearthed a few forbidden books discussing this

mysterious plane of existence. **Base Skill:** 25% +5% per level of experience.

Lore — Religion: A comprehensive study of the world's religions, past and present, their beliefs, rituals, holy places, pantheons of deities and supernatural creatures (demons, spirits, angels), stories of creation, myths and legends. The skill will help the character recognize specific rituals, their purpose, the deity(s), icons, and similar information. **Base Skill:** 30% +5% per level of experience.

Lore — Vampires (NEW): The study of the undead, their habits, origins, powers and weaknesses. The skill will help a character determine if a person is under the sway or control of a vampire, or whether or not a victim has been killed by the undead. It will also aid in differentiating fact from superstition regarding the vampire's vulnerabilities and strength, the few ways to truly destroy them, and basic vampire-hunting tactics. At the higher levels of knowledge (65%+), the character may have some idea about vampire intelligences, the Wampyr sub-race, and other detailed information. **Base Skill:** 30% +5% per level of experience.

Photography: Training in the art of still photography, the use of lighting, cameras, lenses, filters, and other camera equipment, as well as storage, development, enlargement, and duplication of film/photos. **Base Skill:** 35% +5% per level of experience.

Research: Training in the use of methods, techniques, and locations, for finding information, including public records, libraries, federal information services, data bureaus, interviews, surveys, demographics, trade journals, clipping services, computer services, and legal searches. This skill is helpful in locating information about people, places and things. The *game master* will ultimately regulate the availability of accessible, known information regarding a particular subject. In some cases, there may be a ton of history and information, while, in others, very little or nothing at all (which may reveal something by its sheer lack of info). The research skill simply gives characters access to available data. **Base Skill:** 50% +5% per level of experience.

G.M. Note: A good rule of thumb is to let characters investigate/research something as much as they want, but keep the game moving along. If no information is available, find out where they are conducting research and say something like, "Despite the help of a clerk, and three hours of research, you still find nothing (or nothing unusual)." "If the character(s) wishes to keep looking, let him, but quickly click off the hours; "Another hour and still nothing." If another player conducting research elsewhere says, "What do I find in the City County Building?" Make the answer "Nothing", or "Something quite surprising," and tell him/her something in private. Do not drag out the research aspect, but do consider a reasonable length of imaginary game time. Likewise, if the information is common knowledge or easy to locate, fast forward through what might be a couple of hours of research and tell the character what he has found. ANY CHARACTERS CAN DO RESEARCH AND ASK QUESTIONS! However, the research skill will reduce the amount of time by half and the character is trained to notice relevant data that an untrained character is liable to overlook. Thus, for the truly mysterious, secret or difficult information, have the character with the research skill try to uncover it. Only roll to determine success on these difficult or hushed up bits of information, including addresses, unlisted telephone numbers, car license plate numbers, obscure and suppressed data.



Writing: The ability to write prose (stories), poems, or journalistically (article, reports, news). Scholastic training indicates a professional quality, while the secondary skill indicates a talented amateur. A failed roll means an awkward and poorly written work that is boring and difficult to understand. Try again. Note that the written word can be a powerful tool in helping others understand the threats they are facing. **Base Skill:** 25% +5% per level of experience. **Requires:** Literacy.

Weapon Proficiencies

Note: There are two categories of weapon proficiencies (W.P.): Ancient and Modern.

Ancient Weapon Proficiencies:

Each ancient W.P. provides combat training with a particular type of weapon. The result is hand to hand combat bonuses to strike and parry whenever that particular weapon is used. All bonuses are accumulative. Each W.P. counts as one skill. The character may select several W.P.s or few. **Note:** Characters without a W.P. can use any weapon, but without benefit of the W.P. bonuses.

W.P. Archery and Targeting: This is an expertise with thrown and bow weapons. It includes throwing spears, forks, slings, short bow, long bow, cross bow, and modern bows. **Bonuses:** Add 20 feet (6.1 m) to the normal effective range per level of the character, +1 to parry with that weapon (effective at level one), and +1 to strike at levels 2, 4, 6, 8, 11, and 14. **Note:** The character loses all bonuses and rate of fire is half when riding on horse back or a moving vehicle. **Rate of Fire:** Two at level one, +2 at level three, +1 at levels 5, 7, 9, and 12.

Bow/Weapon Type and Ranges	Damage Per Arrow/Weapon
Boomerangs — 60 ft/18.3 m	1D6 damage
Throwing Sticks & Irons — 30 ft/9.1 m	1D6 damage
Sling Shot — 80 ft/24.4 m	1D6 damage
Spear — 100 ft/ 30.5 m	1D6 damage
Short Bow — 340 ft/104 m	1D6 damage
Long Bow — 640 ft/195 m	2D6 damage
Modern Compound Bow — 700 ft/213 m	2D6 damage
Traditional Cross Bow — 600 ft/183 m	1D8 damage
Modern Cross Bow — 700 ft/213 m	2D6 damage

W.P. Battle Axe: Training in all types of battle axes and picks. **Bonuses:** +1 to strike at levels one, four, eight, and twelve. +1 to parry at levels two, five, nine and thirteen. +1 to strike when thrown at levels three, eight and twelve.

W.P. Blunt: Training with all types of blunt weapons, including maces, hammers, cudgels, pikes, staves, and clubs. **Bonuses:** +1 to strike and parry at level one, and another +1 to strike and parry at level four, eight and thirteen.

W.P. Chain: Training with all types of chain weapons, including ordinary lengths of chain, nunchaku, flail, and ball or mace and chain. **Bonuses:** +1 to strike at level one, add another +1 to strike and parry at level four, add another +1 to parry at level eighth, and +1 to strike and parry at level thirteen.

W.P. Knife: Training with all types of knives. **Bonuses:** +1 to strike when thrown at level one, +1 to strike and parry at level two, add another +1 to parry at level four, add another +1 to strike and throw at level seven, add +1 to parry at level eight, and +1 to strike, parry, and throw at level eleven and fifteen.

W.P. Polearm: Training with the large spear-like weapons known as the polearm. Also includes tridents. **Bonuses:** +1 to strike at levels one, five, nine, and fourteen. +1 to parry at levels one, three, six, nine and twelve. +1 to strike when thrown at levels two, five, nine and fourteen.

W.P. Sword: Combat skills with large and small swords, including fencing type training. Includes rapiers, sabers, two handed, and short swords. **Bonuses:** +1 to strike and parry at levels one and three, and add another at levels seven, eleven, and fourteen.

W.P. Whip: Skill at “whipping” or snapping with long, flexible, light weapons. **Bonuses:** Start with +1 to strike at level one. +1 to strike at 3rd, 5th, 7th, 9th, 11th and 13th levels. +1 to damage at 4th, 8th, and 12th. +1 to entangle at 2nd, 6th, 8th, 10th, and 14th levels. A typical whip and Cat-o-Nine tails inflicts 1D6 damage, a bull whip 2D4 damage.

Modern Weapon Proficiencies:

Note: These are areas of training and practiced skill with a particular type of modern weapon. Each W.P. counts as one skill selection. Modern W.P. bonuses are found in the combat section under *Modern Weapon Proficiency Explanation*. Characters with no knowledge of modern weapons can fire loaded weapons, but will take twice as long to reload and always shoot “wild”; no bonuses to strike.

W.P. Revolver: All cylinder style hand guns; not automatic (trigger must be pulled each time the gun is fired).

W.P. Automatic Pistol: All modern military automatic pistols (automatic means the weapon keeps firing while the trigger is depressed and until the trigger is released or the rounds are all expended).

W.P. Bolt-Action Rifle (hunting & sniping): Includes most hunting rifles; not an automatic firing weapon.

W.P. Automatic and Semi-automatic Rifles: Includes all assault rifles like the M-16 and AK-47.

W.P. Sub-Machinegun: Includes all small automatic weapons like the Uzi.

W.P. Heavy: Includes machineguns, bazookas, LAWS, and mortars.

Wilderness

Boat Building: This skill enables the character to build a variety of rafts, small rowboats, large flatbed boats, and canoes. A small raft (two man) can be made within 1D6+1 hours if the lumber or other suitable materials and tools are readily available. A large raft will take about 4D6 hours, a canoe 2D6 days, rowboat 4D4 days, large flatbed 1D4×10 days. Time is doubled or tripled if trees must be cut down and wood prepared. Of course, the time can be reduced if several knowledgeable people are working on the construction. A failed skill roll means the boat has leaks. Trying to patch it will require 4D4 hours. **Base Skill:** 25% +5% per level of experience.

Carpentry: A fundamental knowledge of working with wood. The character knows how to prepare, treat, and preserve wood, recognize quality craftsmanship, can repair damaged wood and wood items, and build (chests, chairs, tables, cabinets, houses, etc.). Adds +5% bonus to the boat building skill if taken. **Base Skill:** 25% +5% per level of experience.

Hunting: The skill of killing and preparing an animal for food. **Special Bonuses:** Add the following bonuses to the appropriate skills: +2% prowl, +5% track animals, +5% skin animals, +5% wilderness survival, and +5% to cook the catch only. No base skill.

Identify Plants & Fruits: Training in the recognition of the many different types of plants and vegetation and where they grow. The emphasis is placed on edible, herbal, and poisonous plants. **Base Skill:** 25% +5% per level of experience.

Land Navigation: This skill enables the person to stay on course while traveling over land by means of observation. It includes mentally marking/recognizing geographic landmarks, estimating distance and movement, recognizing sounds, night travel, and other navigational tricks. The player should roll once for approximately every three miles (4.8 km) traveled. A failed roll means the character is drifting off course; 2D10×100 yards/meters. Consecutive failed rolls means the individual does not realize that he’s off course and continues in the wrong direction.

Note: A group of average men can cover about five miles (8 km) an hour at a brisk, but relaxed, pace through grassland, along dirt roads or pavement. Travel through dense forest or jungle, at a cautious pace, with eyes open for danger, is about one mile (1.6 km) an hour. Heavy rain or snow, fog, swamps, etc., will also reduce speed. **Base Skill:** 36% +4% per level of experience.

Preserve Food: Knowledge in the preparation of foods for storage and later consumption. Includes canning fresh fruit and vegetables, making jams and honey, drying fruit, vegetables, and herbs, drying meat and fish, plus various smoking, salting, and pickling methods. **Base Skill:** 25% +5% per level of experience.

Skin and Prepare Animal Hides: Training in the methods and techniques in skinning, tanning, stretching, and preserving animal hides as fur or leather. Adds a +5% bonus to the sewing skill. **Base Skill:** 30% +5% per level of experience.

Track Animals: This skill enables the character to identify an animal by its tracks, scent, droppings, and habits. The individual can also follow the animal’s tracks and other signs. This means he can also estimate how fresh the tracks are, what direction they are heading, whether the animal is hurt or sick, and guess its age. The habits and habitats of animals and animal behavior are also learned.

Tracking humans with this skill is also possible, but is done with a penalty of -20%. **Base Skill:** 20% +5% per level of experience.



Modern Weapon Combat

MODERN WEAPON PROFICIENCIES

The system for modern weapons presented here is identical to the rules and those found in the pages of the **The Revised Heroes Unlimited, Ninjas & Superspies, Robotech and Rifts**. While I feel these rules play much more quickly and cleanly, the original rules (still found in TMNT) are probably a little more realistic. Game masters and players can use *either* modern weapon combat systems without fear of disrupting the playability of either game.

The following rules *can* be applied to all of *Palladium Books*[®] *role-playing games*.

Weapon Proficiencies (W.P.) are areas of training and practiced skill with a particular type of weapon, such as revolver or sub-machinegun. This skill provides special bonuses to strike when using that weapon. Do not add this strike bonus to your character's hand to hand or combat skill bonuses to strike.

Weapon Proficiencies provide the following bonuses:

Aimed: +3 to strike.

Burst: +1 to strike.

Wild: No bonus or penalty.

Training also enables the character to easily reload, disassemble, unjam, clean and otherwise maintain the weapon. **Recognizes weapon quality** — 30% at level one and +6% per each additional level of experience. **Add a bonus** of +1 to strike for every THREE levels of experience beyond level one. When firing a weapon, there are three main modes or categories of attack: *aimed, burst or wild*.

AIMED

An aimed shot means a person takes the time to carefully aim and squeeze off one, well placed shot. Each individual shot takes one full attack. Thus, if a character has four attacks per melee he/she can shoot FOUR aimed shots. This applies to all weapons. Roll to strike for each shot.

Bonus to Strike is +4 with a revolver or +3 for all others.

BURST

A **burst** is the shooting of several rounds, immediately one after another. Aim is more hasty and the recoil moves the weapon with each shot, reducing the accuracy. *Semi-automatic/automatic weapons, machineguns and sub-machineguns*, are designed for burst firing. The concept is that, while accuracy is reduced, the odds of hitting one's target with multiple rounds is increased because more shots are fired.

Bonus to Strike is +1 with all weapons.

Note: Roll to strike once to see if the entire burst hits. Do not roll for each individual bullet. If the burst misses its target, then all the rounds in that burst miss.

BURSTS OR SPRAYS FROM AUTOMATIC WEAPONS AND SUB-MACHINEGUNS

Short bursts fire 20% of the entire magazine; i.e., 30 round magazine — 6 rounds/bullets are fired. Damage: Roll the normal damage dice for ONE round x2. Uses up one attack. Can be fired at only one target.

Long burst fires 50% of the entire magazine; i.e., 30 round magazine — 15 rounds/bullets are fired. Damage: Roll the normal damage dice for ONE round x5. Uses up one attack. Can be fired at only one target.

Entire magazine: Shooting off the entire clip/magazine within a melee round is possible. 100% of the rounds are fired. Damage: Roll the normal damage dice for ONE round x10. Uses up *two* attacks that melee. Can be fired at only one target. Machineguns are the only exception to this rule.

Spray: Shooting a burst at several targets at once is possible, but the same as shooting wild. You must fire a *long burst or an entire magazine* in order to spray. See shooting wild.

SHOOTING WILD

Shooting wild occurs when a trained character shoots without taking time to aim. This usually applies when the person is blinded, angry, running, rolling, leaping, shooting from a moving vehicle, etc.

Bonus to Strike: With a W.P. there is no bonus or penalty; with no W.P. the person strikes at -6. Long bursts or the entire magazine must be fired. Counts as two attacks. Can be fired at one target or in a spray. Damage for shooting wild at one target: Roll normal damage dice for ONE round x2. Roll once to strike with the wild burst. Hitting an innocent bystander is a real possibility when shooting wild; 20% chance. Roll for each wild burst fired. Damage is the normal damage from one round (a wild shot).

Spraying an area with bullets can be dangerous and is considered to be shooting wild. The object of a spray is to hit several targets simultaneously. **First**, roll once to determine if you strike the target area; 1D20; 5 or higher strikes as usual. Then roll 1D4 to determine how many individual targets are struck within the target area. However, each target gets a roll to dodge to avoid getting shot. Damage is the normal damage from one round. Hitting an innocent bystander is even more likely; 50% chance. Damage is from one round (wild shot).

Bursts or Sprays from a machinegun is different only in the number of rounds fired, targets struck, and chance of hitting a bystander. Machineguns have a much greater ammunition capacity, so it does not have to use the same percentage of its entire clip.

Short burst/one target: 10% of rounds/magazine; inflicts normal round damage x2. Counts as one attack.

Short burst spray: 10% of rounds/magazine; inflicts normal damage from ONE round, hits 1D4 targets.



Long burst/one target: 30% of rounds/magazine; inflicts normal damage x5. Counts as one attack.

Long burst spray: 30% of rounds magazine; inflicts normal damage from ONE round, hits 1D8 targets. Counts as one attack.

Empty the entire magazine/one target: All rounds fired; inflicts normal round damage x20. Counts as all melee attacks/one full melee.

Empty the entire magazine in a spray: All rounds fired; inflicts normal round damage x2, hits 2D8 targets. Counts as ALL melee attacks/one full melee. Chance of hitting innocent bystanders is 70%.

A Special Note About Shotguns:

Shotguns can fire once or twice per melee (double-barrel). It can fire both rounds simultaneously or one at a time. Buckshot scatters, and will strike the specific target plus 1D4 others within its blast area (approximately a 15ft/4.6m area).

NATURAL ENERGY BLASTS

Supernatural characters whose power enables them to emit energy blasts, whether it be fire, electricity, or other forms of energy, can use their energy attack as often as their combined hand to hand attacks allow. For Example: If the creature has FOUR hand to hand attacks, it can fire energy blasts as often as FOUR times per melee (15 seconds). If the character has five or six hand to hand attacks, five or six blasts can be fired. As always, the types of attacks can be combined.

HAND TO HAND COMBAT

The combat system of Nightbane is really just an adaption of the rules from Heroes Unlimited and Ninja Turtles. It is designed to be fast moving and easy to understand. All combat strikes, parries and dodges are resolved by rolling twenty-sided dice.

STEP 1: Determine Initiative

Any time opponents square off for battle, the game master must determine who has the initiative. In other words, who will attack first. Successful *Sneak Attacks* or *Long Range Attacks* will always have initiative for that melee. Otherwise, whoever *rolls highest* on a twenty-sided die will attack first. In the case of a tie, reroll. Initiative is rolled only once per melee. That roll will determine the pace for that entire melee.

STEP 2: Attacker Rolls Strike

The next step is for the first attacker to **roll a twenty-sided die**. If the result is a four or less (counting bonuses), then the attacker misses. *Any roll above a four (4) hits the opponent*. But, if the roll is a five (5) or better, *and less than the opponent's Armor Rating (A.R.)*, then damage may be done only to the S.D.C. of the opponent's armor (see A.R./Artificial Body Armor). A roll over the opponent's A.R. does direct damage to the charac-

ter's S.D.C. and Hit Points. Note that special attacks like Knock-out/Stun or Death Blow must be declared BEFORE rolling to strike.

STEP 3: Defender May Parry, Dodge or Entangle

Any time an attacker rolls a successful hit, the defender can choose to parry, dodge, or entangle. *Parrying* can be done automatically by anyone trained in any form of Hand to Hand combat. That means that the parry can be performed without wasting a melee attack. Non-combat trained characters will lose their next melee attack every time they parry.

NOTE: Bullets and energy attacks cannot be parried, but CAN be dodged. Defending by dodging or entangling means automatically giving up the next melee attack.

Entangle means the character actually pins or snares an opponent's weapons or arm. The defender can only defend against attacks within his line of vision. Attacks from the rear cannot be parried, dodged or entangled.

STEP 4: Attacker Rolls Damage

If a successful strike is not parried, dodged or entangled, the attacker rolls for the amount of damage inflicted and adds any damage bonuses. Critical strikes do *double damage*. Combined critical strikes, like a natural twenty and a jump attack, do triple damage. Add the damage bonus to the roll before doubling or tripling. A natural, unmodified, 20 is always a critical strike. A normal punch inflicts 1D4 damage.

STEP 5: Defender May Attempt To Roll With Punch

If the attack is a blunt, physical attack (fist, foot, club, staff, etc.), then the defender can attempt to Roll With The Punch. In order to roll with punch, the defender must match or better the attacker's roll to strike. Successfully rolling with a punch means the character takes *half* damage. Successfully rolling with a knockout punch means the character takes double damage, but is NOT unconscious or stunned. Rolling with a death punch results in loss of half of all remaining S.D.C. and hit points. Failing to roll with punch means taking full damage off of the defender's S.D.C. and/or hit points. The same rules apply to falls as well.

Continuing The Combat

Once the above is completed, the process is repeated for whoever lost the initiative. So long as the opponents have melee attacks left, the combat continues back and forth. When all the attacks or actions per melee round of all opponents are finished, it's time to start a new melee round. Initiative is redetermined at the *beginning* of every melee round. That is to say, that if a character has four attacks per melee, when *all* attacks are used, a new melee round begins.

COMBAT TERMS

A.R.: This is a character's **Armor Rating**. The A.R. indicates what an attacker must roll in order to do damage to the character. Any roll of 5, or better, will strike a character with no body armor. Characters with **Artificial Body Armor**, metal armor, bulletproof vests, etc., can easily be successfully attacked by rolls falling under the artificial armor's A.R.; doing damage to the S.D.C. of the *body armor*, but not to the S.D.C. of the defender. Or, by striking above the armor's A.R., damaging the character's personal S.D.C. and/or hit points, but not the body armor S.D.C. **Example:** A defender has a natural A.R. of 5 and is wearing body armor with an A.R. of 8. If the attacker rolls 9 or better, then damage is done directly to the defender. A roll of 5, 6, 7, or 8, would only hurt the body armor, not the wearer. A roll of 1, 2, 3, or 4, would totally miss.

Damage Table (Basic)

Human Fist — 1D4

Human Kick — 1D6 or 1D8

Black Jack — 1D6

Bull Whip — 1D8

Thrown Small Objects — 1D4

Falling — 1D6 per 10ft (3.0 m)

Collision — 1D8 per 10mph (16 kmph)

Smashing through Glass — 1D4

Dropped or Thrown

Large Objects — 1D8 per 100lbs (45 kg)

1D8 per 40ft, and 1D4 per 4mph (6.4 kmph)

Death Blow: An automatic kill. The defender can try to roll with death blow by rolling over the attacker's strike. If the defender is not killed, then the current S.D.C. and hit points are reduced to half. This attack is available only under certain conditions.

Dodge: A character dodges by moving out of the way of the attack. Dodging always takes up one attack/action per melee round. To Dodge, the defender must roll higher than the attacker's strike roll on a twenty-sided die.

Entangle: A defender can attempt to trap the weapon or arm of an attacker. This is done instead of parrying or dodging, and takes up one attack per melee. An entangle is successful if the defender rolls above the attacker's strike roll. It takes one attack and a roll to entangle to keep an opponent's arm or weapon entangled every melee round. In order to get free, the entangled opponent must roll a dodge against the entangle roll.

Hand to Hand Combat: Fighting skills that provide the characters with attacks per melee, bonuses, and techniques. Characters without combat training have only one attack per melee and have no automatic chance to parry.

Hit Points: This is the number of points of damage a character can take before dying. Characters don't lose hit points until their S.D.C. is down to zero. A character's base hit points is the P.E. plus 1D6. Another 1D6 of hit points is gained every time the character advances an experience level. Lost hit points are not recovered without medical attention.

Initiative: Whoever gets to attack first is considered to have the Initiative. Initiative is automatic in sneak attacks and long-range attacks. In most other cases, each opponent rolls a

twenty-sided, highest roll gets the initiative. Rolling for initiative takes place at the beginning of each melee round of combat.

Kick Attack: This is a karate-style kick. It is a normal attack that does 1D4 damage for the untrained, or higher with hand to hand skills (1D6 or 1D8). Anyone trained in hand to hand combat can do a kick attack.

Knockout/Stun: Anyone hit by a knockout or stun attack will be temporarily incapacitated. The victim is not necessarily unconscious, just dazed.

Jump Kick: A Jump Kick is performed by leaping completely off the ground and attempting to land feet-first on an opponent. Jump Kick can be used only by those skilled in hand to hand martial arts. The advantage of a jump kick is that it works as a *critical strike* and doubles the normal damage inflicted. The disadvantage of a jump kick is that no other attack may be performed in that melee round (all attacks for that melee are used up in the kick). The jump kick must be the character's first attack of that melee round. For the rest of the melee round, the character can only parry, dodge or move into position.

Leap Attack: An airborne assault where the weapons and/or fists are wielded in mid-leap. A leap attack must be made only at the beginning of a melee round and, like the jump kick, uses up *all* attacks for that melee. Usually, only a single strike can be made during a leap attack. However, if two opponents are close together, the attacker can leap between them and strike both of them at the same time; roll to strike for each character. After the leap, the character may not attack again until the next melee round, but can parry or dodge or move into position. Automatic parries work in mid-leap, but dodges are impossible. A successful leap attack is a critical strike and does double damage.

Long-Range Attack: By using a long-range weapon from a distance, an attacker can perform an undetected, *first strike*. Provided the attacker is not seen, the defender automatically loses initiative and may not dodge the first attack that melee round.

Melee or Melee Round: Exactly 15 seconds. The segment of time combatants have to strike, counter and/or return strike. Generally, playing characters have two or more attacks per melee.

Multiple Attackers: Takes place when an opponent is faced by more than one attacker. Characters with hand to hand combat skills can attempt to parry any attacks within their line of sight. The defender from multiple attackers can strike at only one target at a time (see leap attack for a rare exception).

Natural Twenty: This is the result of 20 when rolling a twenty-sided die. A strike with a natural twenty will always be a critical strike. If someone with a strike bonus of +2 rolls an 18, then they have an attack roll of 18 *plus* unnatural, bonus modification; NOT a natural twenty, and is not a critical strike. A natural twenty beats all other rolls and can only be parried or dodged by *another natural twenty*.

Paired Weapons: Certain kinds of weapons, such as Sais, Nunchaku, knives, clubs and swords, can be used as paired weapons. Masters of paired weapons can strike and parry simultaneously, can do twin strikes against a single target or against a pair of targets, and can parry two, different opponents at the same time. In other words, warriors skilled in

paired weapons often can do two actions for every one of their melee attacks. BUT, every time they use twin actions they LOSE their automatic parry.

Parry: A defender can attempt to parry most physical attacks. This is done by blocking the attacker's blow with a weapon or hand. Characters trained in hand to hand combat can parry without losing melee attacks. Bullets and energy attacks *cannot* be parried!

Pull Punch: The ability to control the force of a hand to hand attack. Usually used to reduce the blow to less than killing force. The character can choose to do half damage, quarter damage, a single point or no damage at all. A character must declare a pulled punch, and the player must roll 11 or better on a twenty-sided die; failure means full damage is inflicted.

Roll with Punch/Fall: Hand to Hand combat fighters can reduce the damage from blows and falls by rolling. If the defender is successful, then only half damage is taken. Roll with punch/fall does not work against energy blasts, bullets, fire, bladed weapons, psionics or radiation. Victims must roll higher than the attacker's roll. *Falling* characters must roll a 14 or higher, on a twenty-sided die, to roll with the fall.

Saving Throws: Occasionally, characters must roll to save against exotic attacks like poison, gas, insanity, psionics, etc.

Lethal Poison — 14 or better

Magic: Spell — 12 or better

Magic: Ritual — 16 or better

Non-lethal Poison — 16 or better

Harmful Drugs — 15 or better

Acids — No save possible. Dodge!

Insanity — 12 or better

Psionics — 15 or better for non-psionics

10 or better for psionic

S.D.C.: This stands for *Structural Damage Capacity*, which is the amount of damage an object can absorb before breaking. Living creatures also have S.D.C.; it represents their physical resistance to damage. All the S.D.C. of a living thing must be reduced to zero before the hit points can be affected.

S.D.C. Table (Basic)

Below are the S.D.C. values for a variety of objects. When an object's S.D.C. is reduced to zero, it is considered broken. Game masters should exercise common sense in applying these values. For example, a normal human cannot break through a vault door with bare fists, no matter how many times natural twenties are rolled.

The S.D.C. of different weapons is applied only if someone is actually attempting to break the weapon. A properly wielded sword can inflict or parry many times its S.D.C. On the other hand, using the sword to wedge open a door could easily snap it off.

It is also important to note that the S.D.C. applies to the entire object. A bullet can penetrate many objects with only a small fraction (about 2%) of S.D.C. loss. For example, if a bullet, punching through an exterior brick wall, hits a target, it would inflict normal damage minus the 4 points of S.D.C. it wasted getting through the wall.

Airplane, Single Engine — 400 S.D.C.

Airplane, Jet Airliner — 2000 S.D.C.

Boat, Canoe/Rowboat — 40 S.D.C.

Boat, Cabin Cruiser — 450 S.D.C.

Boat, Cargo Freighter — 8000 S.D.C.
 Box, Wood Shipping Crate — 12 S.D.C.
 Box, Metal Shipping Crate — 48 S.D.C.
 Car, Compact — 250 S.D.C.
 Car, Luxury — 450 S.D.C.
 Car, Door Only — 150 S.D.C.
 Car, Windshield Only — 100 S.D.C.
 Door, Interior Wood — 100 S.D.C.
 Door, Exterior Wood — 170 S.D.C.
 Door, Metal Grill — 350 S.D.C.
 Door, Solid Metal — 600 S.D.C.
 Door, Metal Safe — 800 S.D.C.
 Door, Bank Vault — 5000 S.D.C.
 Handcuffs, Regular — 60 S.D.C.
 Handcuffs, Heavy — 120 S.D.C.
 Lock, Common Latch — 40 S.D.C.
 Lock, Dead Bolt — 100 S.D.C.
 Lock, Heavy Padlock — 75 S.D.C.
 Motorcycle — 100 S.D.C.
 Truck, Medium Sized Pick-up — 450 S.D.C.
 Truck, Half-Ton Pick-up — 600 S.D.C.
 Truck, 18 wheeler — 800 S.D.C.
 Wall, Interior Plaster — 120 S.D.C.
 Wall, Exterior Wood — 150 S.D.C.
 Wall, Exterior Brick — 200 S.D.C.
 Wall, Cinder Block — 300 S.D.C.
 Wall, Reinforced Concrete — 400 S.D.C.
 Weapon, Hard Wood — 40 S.D.C.
 Weapon, Metal Sword — 100 S.D.C.
 Weapon, Small Pistol — 35 S.D.C.
 Weapon, Assault Rifle — 75 S.D.C.
 Weapon, Artillery Piece — 1500 S.D.C.
 Window, Ordinary Glass — 20 S.D.C.
 Window, Plexiglass — 35 S.D.C.

Simultaneous Attack: Instead of defending with a parry, dodge or entangle, a character can choose to do a simultaneous attack. In this case, the character does not defend ("Go ahead, hit me; I can take it!") and simply attacks in response. The advantage of a simultaneous attack is that *neither* opponent can parry, dodge or entangle. In all probability, both will take damage. *Exception:* An opponent with paired weapons can engage in simultaneous attack (with one weapon) AND parry (with the other), OR, both the paired weapons can be used to strike with NO parry.

Sneak Attack: An attacker may lie in wait (ambush), attack from behind, or sneak up (prowl) on an opponent. If the foe does not discover the attacker, then the sneak attack is successful. The sneak attacker always has initiative, and the defender is not able to parry or dodge the sneak attack.

Strike: Anyone attempting to hit an opponent must roll to strike. As with all combat rolls, a roll to strike is made with twenty-sided dice.

Throw: Simply, this means throwing a weapon. Rolling to throw is exactly the same as rolling to strike, except that there are different bonuses per weapon type. See Weapon Proficiency.

NOTE: A character may use ANY type of weapon, but gets no combat bonuses, such as strike or parry, unless he has a Weapon Proficiency (W.P.) in that particular weapon. This applies to modern and ancient weapons.



HAND TO HAND: BASIC

- Level** 1 Two attacks per melee; +2 to pull/roll with punch, fall or impact.
2 +2 to parry and dodge.
3 Kick attack does 1D6 points damage.
4 One additional attack per melee.
5 +1 to strike.
6 Critical strike on an unmodified roll of 19 or 20.
7 +2 to damage.
8 Judo-style body throw/flip; does 1D6 damage, and victim loses initiative and one attack per melee.
9 One additional attack per melee.
10 An additional +2 to pull/roll with punch, fall or impact.
11 An additional +1 to parry and dodge.
12 An additional +1 to strike.
13 Critical strike or knockout from behind.
14 An additional +2 to damage.
15 An additional attack per melee.

HAND TO HAND: EXPERT

- Level** 1 Two attacks per melee; +2 to pull/roll with punch, fall or impact.
2 +3 to parry and dodge.
3 +2 to strike.
4 One additional attack per melee.
5 Kick attack does 1D6 damage.
6 Critical strike on an unmodified roll of 18, 19 or 20.
7 Paired weapons.
8 Judo-style body throw/flip; does 1D6 damage, and victim loses initiative and one attack.
9 One additional attack per melee.
10 +3 to damage.
11 Knockout/stun on an unmodified roll of 18, 19 or 20.
12 An additional +2 to parry and dodge.
13 Critical strike or knockout from behind (triple damage).
14 An additional attack per melee.
15 Death blow on a roll of natural 20.

HAND TO HAND: MARTIAL ARTS

- Level** 1 Two attacks per melee; +3 to pull/roll with punch, fall or impact.
2 +3 to parry and dodge; +2 to strike.
3 Karate-style kick does 1D8 damage.
4 One additional attack per melee.
5 Jump Kick (critical strike). Entangle.
6 Critical strike on an unmodified roll of 18, 19 or 20.
7 Paired Weapons.
8 Leap Attack (critical strike).
9 One additional attack per melee.
10 Judo style body throw/flip; does 1D6 damage victim loses initiative and one attack.
11 An additional +4 to damage.
12 An additional +2 to parry and dodge.
13 Knock out/stun on an unmodified roll of 18, 19 or 20.
14 An additional attack per melee.
15 Death blow on a roll of a natural 20.

HAND TO HAND: ASSASSIN

- Level** 1 +2 to strike.
2 2 attacks per melee.
3 +3 to pull/roll with punch/fall.
4 +4 to damage.
5 One additional attack per melee.
6 +3 to parry/dodge. Entangle.
7 Knock out/stun on an unmodified roll of 17-20.
8 One additional attack per melee.
9 Kick attack does 1D6 damage.
10 Critical strike on an unmodified roll of 19 or 20.
11 +2 to strike.
12 Death blow on a roll of a natural 20.
13 One additional attack per melee.
14 +2 to damage.
15 +2 to strike.

Note Hand to Hand Assassin: This is taught to characters trained by secret organizations (CIA, Mafia, etc.), this is the specialized science of killing. It includes learning Automatic Parry, Pull Punch, Roll with Punch/Fall, Kick Attack (1D6 damage), Knockout/Stun, Critical Strike and Death Blow. It does NOT include the ability to do Jump Kick or Leap Attack.

PSYCHIC COMBAT ATTACKS PER MELEE

Psychic combat is quick and simple. Each psychic attack counts as one of your character's physical attacks. Thus, if your character has four hand to hand attacks per melee, he or she can substitute up to four psychic attacks. Of course, a player can mix the physical and psychic in any combination, three physical and one psi-attack or two physical and two psychic attacks and so on. Most psychic powers are not appropriate for combat, but during a combat sequence, each physical and psychic *activity* counts as one *combat action*/attack that melee. The total number of combat actions per melee is equal to the total hand to hand attacks per melee. Note that some psi-abilities require time to prepare which might make any other attacks/action impossible.

A reminder: All *player* characters automatically start off with two attacks/actions per 15 second melee. Additional attacks per melee are gained from the hand to hand skills and boxing. A **typical non-player character** gets only one attack per melee plus hand to hand combat and/or boxing skill additions. A **supernatural creature's** number of attacks vary with each individual type, usually two to six attacks per melee. The rules for mixing or substituting psychic attacks still apply.

SAVING THROWS AGAINST PSYCHIC ATTACKS

Psychic attacks which assail the mind, emotions or physiology of a person can always be fought off through the force of one's own will and mental endurance. Psychic attacks that fall into this category include: empathy, empathic transfer, telepathy, mind control, hypnosis, and bio-manipulation. Some psychic powers for which there is no saving throw are telekinesis, levitation, pyrokinesis, presence sense, and see aura.

Even ordinary people have a chance of fighting or saving against a psychic attack. However, those who have psychic abilities have a much better defense against such attacks than ordinary people.

To save against a psychic attack, a 20-sided die is rolled to mentally parry the attack. A high roll will successfully save against the assault, indicating that the person is NOT affected by the psi-power (no damage or reaction).

Non-psychics must roll a 15 or higher to save against psi-attacks.

The other psychics need only roll a 10 or higher. Each P.C.C. will indicate the roll needed.

Note that many of the characters also get a bonus to save vs psychic attack. For simplicity's sake *all supernatural creatures* must roll a 15 or higher to save, but most have bonuses to save against psi-attacks.

INNER STRENGTH POINTS

The use of a particular psionic ability draws upon the astral body or inner strength of the individual. Each specific psionic power will indicate exactly how many I.S.P. are required to perform that ability. When a psionic has exhausted all of his I.S.P. he is unable to perform any more psionic feats until he has had sufficient rest.

The recovery of I.S.P. can be done in one of two ways: *Total Relaxation* and/or sleep at a rate of 2 I.S.P. for every hour, or through meditation. *Meditation* is a skill ability in which the psychic places himself in a simple hypnotic trance. This meditative trance provides maximum relaxation, recovering 4 I.S.P. per hour.

Perception Rolls (NEW)

This type of roll uses the same mechanics as combat, horror factor, and saving throws. **Perception rolls** are used to simulate the character's five senses (sight, hearing, smell, taste and touch) in situations where noticing something might be important or relevant. Searching a room, standing watch, listening through a door, peering into night-shrouded underbrush to see what might be lurking there — these are all situations where a perception roll might be called for.

To determine whether the character's perception finds something, the player must roll a 20-sided die. Add I.Q. bonuses (use the M.E. bonus table, but use I.Q. instead), and any O.C.C. and R.C.C. bonuses. Also, all characters get a +1 to perception at levels three, nine, and fifteen. The Game Master then compares the roll to the table below.

Situation	Perception Roll Number
Easy ; hearing a loud noise, finding a bright-colored object against a white background	4 or better.
Moderate ; looking for somebody in a well-lit area; hearing a slight noise.	8 or better.
Challenging ; looking for something in a poor light; hearing something over a noisy background.	14 or better.
Difficult ; finding something in the dark; hearing a snake sliding over a carpet.	17 or better.

Combining Perception rolls with Skills: A number of skills, among them prowl, detect ambush, concealment, and detect con-

cealment, all may impact on perception rolls. When a perception roll is attempted against a skill roll, treat it as a combat roll; both characters (the person using the skill and the one using a perception roll) roll a D20, and the higher roll wins. To quickly convert a skill percentage, divide the skill total by 15. **Example:** Roger is sneaking up on a Nightbane. Roger's prowl skill is 70%; the Nightbane has a perception bonus of +5. The Prowl skill is converted to +4. Two twenty-sided dice are rolled. Roger's roll total is 11; the Nightbane's perception roll is a 21 — the Nightbane turns towards Roger, fangs bared ...



THE HORROR FACTOR

All supernatural creatures have a horror factor. The horror factor represents either the hideous appearance of the monster or its overwhelming aura of evil and power (or a combination of the two). Whenever a human encounters one of these monstrosities,

the character must roll a 20-sided die to see whether or not he or she is momentarily stunned by the sheer horror of the thing. This horror factor roll might be thought of as a saving throw or mental parry. Fortunately, the characters only need to roll for the first melee of each encounter, *not* every melee of combat.

To save against the Horror Factor (H.F.) the player must roll a 20-sided die. Just like a parry, the roll must be equal or higher than the horror factor. For Example: A slobbering creature, with a horror factor of 10, emerges from a crypt. All characters must roll to save against horror. A successful save is 10 or higher on one roll of a 20-sided die. Everybody except poor Tom

rolls above a 10. Tom rolls a 6, his character is momentarily stunned with horror.

A **failed roll** means that the character is so overwhelmed with horror that he or she is temporarily stunned. What this translates to in game terms is that the character loses initiative (don't even roll for it), loses one attack/action that melee, and is the *last* person to attack/take action and can not defend himself against the creature's *first* attack that melee (no parry or dodge). Fortunately, the character snaps out of the shocked stupor quickly and can join in the combat that same melee. By the second melee, the character has completely regained his senses, functioning as normal.

Psionic Powers

Psionics are the powers of the mind, often known as Extra-Sensory Perception (ESP), telepathy, psychokinesis, and similar terms. In the world of **Nightbane**, psychic powers are a powerful and very real force which can affect thoughts, the physical world, and the living bodies of people or animals. Dark Day and its aftermath has increased the overall psychic energies in the world, multiplying the numbers and powers of people with psychic abilities.

All character classes that deal mostly with psionic powers are known as *Psionic Character Classes (P.C.C.s)*. Only one P.C.C. is presented in this book. Future **Nightbane** sourcebooks will develop a number of new P.C.C.s and new psychic abilities. The Psychic Sensitive, Nega-Psychic, Psi-Mechanic and others can be found in the pages of **Beyond the Supernatural** and are suitable for use in **Nightbane** without need for conversion.

Inner Strength Points

Every use of a psionic ability temporarily uses up a certain amount of psychic energy we call **Inner Strength Points (I.S.P.)**. Each specific psionic power will indicate exactly how many I.S.P. are required to perform that ability. When a psionic has exhausted all of his I.S.P., he is unable to perform any more psionic feats until he acquires sufficient rest.

Meditation & Recovery of Inner Strength Points

Meditation is an automatic skill/ability known to all psychics. It is the only ability that can be done at any time and costs no I.S.P. to perform. Meditation is not so much a psi-power as it is a mental discipline that enables the psychic to concentrate deeply and focus one's abilities and thoughts. The exact techniques of meditation may vary from focusing on a mental object or notion to chanting or humming a mantra. The result, regardless of technique, is a deep relaxation and focus to achieve insight and harmony into one's self and the world around him.

A relaxing meditative state also offers the following benefits to all psionics: one hour of meditation restores six (6) I.S.P. and is the equivalent of two hours of sleep/rest for the physical body.

Inner Strength Points can also be restored during sleep and/or total relaxation at a rate of two (2) per hour.

Saving Throws Against Psionic Attacks

Psionic attacks which assail the mind, emotions, or physiology of a person can always be fought off through the force of one's own will and mental endurance. Psionic attacks that fall into this category include empathy, empathic transmission, mind wipe, telepathy, hypnotic suggestion, and bio-manipulation. Some psionic attacks for which there is no saving throw include levitation, pyrokinesis, telekinesis, presence sense, healing touch, force field, and mind bolt. However, a parry or dodge may be appropriate in some cases, like dodging a mind bolt or telekinetic attack.

All saving throws are made on a 20-sided die. **Non-psionic** characters must roll a *15 or higher* to save vs psionic attack. **Minor** and **Major psionic** individuals must roll a *12 or higher* to save.

Master psionic characters, including all psychic P.C.C.s, need to roll a *10 or higher* to save. **Note:** Be certain to add any possible bonuses from the M.E. attribute and/or any other sources of protection.

The Influence of Ley Line Energy

Range and **duration** are increased by 50% when near a ley line (within two miles/3.2 km) and doubled when within a mile (1.6 km) of a *nexus* point.

Damage from psionic energy attacks, such as psi-sword, pyrokinesis, electrokinesis, and telekinesis, is doubled when within a mile of a ley line *nexus* point (there's no additional damage from a ley line alone). **Note:** Most damage-causing psionic abilities are not described in this book, but will be in future **Nightbane** sourcebooks.

Attacks per Melee

Equal to the number of physical, hand to hand attacks (usually 2 to 5). *See Psychic Combat in the Combat Section.*

Psionic Abilities in Animals

Most large mammals seem to have innate, natural psychic senses that warn them about the presence of supernatural forces. As odd as it may seem, animals associated closely with humans

on a friend/helper level have the most pronounced psi-abilities. Thus, dogs, cats and horses exhibit the greatest extrasensory perception. **Each animal has the following abilities:** See the invisible, sense evil, sense magic, sixth sense and empathy (receives only).

Each ability is an automatic instinct that helps the animal *avoid* the supernatural. **Range:** 600 foot area (183 m). The animal will sense the use or presence of these forces in the area, but also in specific people or creatures as well. The animal's reactions will always be the same; intense nervousness, jumpiness, whimpering, hissing, growling, howling and alertness when psionic and magic energies are sensed to be nearby. If possible, the animal will try to leave the area and flee if he gets the opportunity. Only a loyal canine companion may stay with his human friend/master.

When cornered face to face with the source of magic or supernatural forces, the animal will attack and attempt to flee. A dog or cat will raise the hairs on its back, bare fangs and growl or hiss in a menacing warning. A horse will whine, stomp and rear. If the person or creature does not back off, the animal will attack. The cat and horse will attack only to make a path of escape and to let the unnatural being know that they know its true essence. 1-60% of the time, all canines will attack to kill! The remaining 40% of the time (61-100%) the animal will flee. **Note:** Dogs, cats, and other animals *cannot* be trained to sniff out magic or supernatural creatures. Their natural instinct is to run away. They will NOT search out these forces for anybody or any reason, and will flee as soon as the opportunity arises.

The animal's use of psychic abilities is automatic and natural. Consequently, they do not get an I.S.P. rating.

Animals and Magic

All living creatures have potential psychic energy points. An arcanist, especially evil ones, may sacrifice an animal to get its potential psychic energy. Remember, the P.P.E. of all creatures doubles at the moment of death and a sorcerer can capture and use that energy when it is unleashed.

The following is a list of animal types, their P.P.E., and Hit Points:

Birds (small) - 1D4 P.P.E./1D4 Hit Points
Birds of Prey - 2D6 P.P.E./1D6 Hit Points
Mouse - 1D4 P.P.E./One Hit Point
Rat/Other Rodents - 2D4 P.P.E./1D4 Hit Points
Domestic Cat - 3D4 P.P.E./2D4 Hit Points
Wild Cats (Predator) - 3D6 P.P.E./6D6 Hit Points
Large Wild Cats (Lion/Tiger) -4D6 P.P.E./6D6 +20 Hit Points
Small Canine - 2D6 P.P.E./3D6 Hit Points
Large Canine - 3D6 P.P.E. /4D6+10 Hit Points
Wolf - 4D6 P.P.E. /6D6 +15 Hit Points
Bear - 2D6 P.P.E./3D4 x 10 Hit Points
Mustelid (Weasel/Badger) - 2D6 P.P.E./4D6 hit Points
Cattle - 4D6 P.P.E./4D6+10 Hit Points
Horse - 4D6 P. P. E. /6D6+10 Hit Points
Monkey - 2D6 P.P.E./2D6 Hit Points
Apes - 4D6 P.P.E./4D6+6 Hit Points
Lizard - 1D6 P.P.E./1D6 Hit Points
Fish - 1D4 P.P.E./1D4 Hit Points

Animal Saving Throws

Animals, like humans, get an automatic roll to save vs magic attacks, however, all such saves are -4.

Animals also get to save vs psychic attacks and must roll a 15 or higher to save.

Note: An incapacitated animal prepared for sacrifice is helpless and an automatic kill (death blow).



The Psychic P.C.C.

Dark Day didn't just herald an invasion from another world. It also raised the psychic energies coursing through the planet. Thousands of "normal" men and women, who might have had occasional psychic flashes, hunches, or premonitions, suddenly felt their powers come to life in an unprecedented way. Existing psychics who had already mastered their abilities to some degree, often found their powers expanded and more reliable.

Psychics have a number of abilities which allow them to sense the supernatural, manipulate the world with the power of the mind alone, and even heal wounds and disease. These powers have the unfortunate side-effect of revealing to them the Nightlords and their minions, which makes them targets for extermination! Persecuted by the monster-controlled government, psychics have to hide and seek the companionship of other outcasts (like the Nightbane). Many have decided to fight back and have joined forces with secret societies, cults, the Nightbane, the Spook Squad and others. Some have become psychic mercenaries, others adventurers, and some still try to hide and live in peace.

This P.C.C. assumes that the psychic was a young, normal man or woman who has suddenly discovered new abilities, and may soon be forced to abandon his/her normal life.

The Powers of a Psychic:

1. **At first level**, the psychic automatically has the following abilities:

See Aura
Sense Evil
Meditation
Presence Sense

2. **Additional psionic abilities:** In addition to the above, the psychic character gets to select two powers from each of the healing, sensitive and physical categories. One additional power can be selected from any category for each additional level of experience.

3. **I.S.P.:** To determine the character's amount of Inner Strength Points, take the number of M.E. as the base, roll 1D4×10, and add it to the base number. The character gets another 10 I.S.P. for each additional level of experience. Considered to be a master psionic.

4. **P.P.E.:** Most of the character's P.P.E. has been expended in the development of psychic abilities. Permanent **P.P.E. Base:** 1D6.

Attribute Requirements: Only psionic powers, but a high I.Q. and M.E. are strongly recommended.

P.C.C. Skills: Determine the character's work or educational background. A college student might have a good grasp of two or three scientific or technical skills, while a blue-collar worker might know a number of mechanical, electronic or domestic skills.

Speak/Literate in Native Language 98%
Select 4 work-related/educational-related skills (+15%)
Select 1 Domestic skill of choice (+10%)

Hand to hand: basic can be selected as one "other" skill, hand to hand: expert at the cost of two "other" skills, or martial arts (or assassin if an evil alignment) for the cost of three "other" skills.

P.C.C. Related Skills: Select 10 other skills. Plus one additional skill at levels three, five, eight, ten and thirteen. All new skills start at the base skill level.

Communications: Any
Domestic: Any (+5%)
Electrical: Any (+5%)
Espionage: Wilderness survival only.
Mechanical: Any (+5%)
Medical: Any (any skill other than first aid, holistic medicine and Paramedic counts as two skill selections, however)
Military: None
Physical: Any
Pilot: Any (+5%)
Pilot Related: Any
Rogue: Any
Science: Any (+5%)
Technical: Any (+5%)
W.P.: Any
Wilderness: Any (+5%)

Secondary Skills: The character also gets to select six secondary skills. These are additional areas of knowledge that do

not get the benefit of the bonuses listed in parentheses. All secondary skills start at the base skill level.

Standard Equipment: Varies with occupation/background, plus a basic car, pick-up truck or motorcycle.

Money: 3D6×100 in cash and 1D6×1,000 in possessions.

Descriptions of Psychic Abilities

AN ALPHABETICAL LIST OF ALL PSYCHIC ABILITIES

Sensitive

Astral Projection
Clairvoyance
Death Trance
Divination
Empathic Transmission
Empathy
Meditation
Mediumship/Clairsentience
Mind Block
Object Read/Psychometry
Presence Sense
See Aura
See the Invisible
Sense Evil
Sense Magic
Sixth Sense
Speed Reading
Suggestion
Summon Inner Strength
Telepathy
Total Recall

Physical

Alter Aura
Bio-Manipulation
Death Trance
Ectoplasm
Electrokinesis
Hydrokinesis
Impervious to Cold
Impervious to Fire
Impervious to Poison
Levitation
Meditation
Mind Block
Pyrokinesis
Resist Fatigue
Resist Hunger
Resist Thirst
Speed Reading
Summon Inner Strength
Telekinesis
Total Recall

Healer

Deaden Pain
Exorcism
Healing
Healing Touch
Impervious to Cold
Impervious to Fire
Increase Healing
Induce Pain
Induce Sleep
Psychic Diagnosis
Psychic Purification
Psychic Surgery
Resist Fatigue
Suggestion

PSYCHIC SENSITIVE ABILITIES

Astral Projection

Range: Self

Duration: 5 minutes per level of experience.

I.S.P.: 8

Through intense concentration/meditation (4D4 minutes of preparation) the psychic can free his mind, or inner self, from his physical body. This psychic inner self is the astral body, a whitish, semitransparent, ghostly image of the character's physical form. A long silver thread or *cord* connects the astral body with its physical self. If the cord is severed the character is likely to die of sudden shock as body and soul are torn asunder. There is only a 30% chance the astral self can locate its physical body without the silver umbilical cord (roll best 2 out of 3).

The physical body lapses into a coma-like trance when the astral self has left it. In this state the body is completely helpless. It can not walk, move or think; it is completely catatonic.

The hazards are threefold. **First**, if the physical body is killed, the astral body is forever lost and will fade away within six hours. **Second**, if the astral body gets lost or captured while in the astral plane, the body will begin to waste away and die. (**Note:** One minute of our time is equal to one week in the astral plane). **Third**, the astral body is vulnerable to psychic attacks and attacks from ghosts, entities and creatures of the astral plane.

There are two levels of astral projection, *coexistence* (physical body and spirit form) in the material world and/or *the astral plane* (another dimension). Astral projection from the physical body into the *material world* creates a ghostly specter of the astral self which can be seen only by other psychics, young children under 13 years old, animals and most supernatural creatures. While in astral form, the character automatically gains the ability to float, fly (mach one/670 mph maximum), see the invisible, pass through solid objects, impervious to physical harm (including cold, heat and energy), and see and hear as usual. The astral body can not communicate with the physical world except through telepathy or empathy, nor speak to, smell or touch anything on the material plane. The astral self is little more than a mute, ghostly observer. Of course, this is a great way to locate invisible supernatural entities, as well as spy on other humans on the material plane (although limited by short sprints. See duration).

Traveling in astral form has its own very special dangers. While the character can see the invisible and other astral travelers, they can also see him. This makes him susceptible to their psychic and astral form attacks, for two astral travelers can lock into hand to hand combat as well. The most vulnerable target is the silver cord which is the astral traveler's lifeline to the physical world. Fortunately, the cord has an *Astral S.D.C.* which is two times that of the person's physical hit points and S.D.C. combined. The thread-like silver cord is a difficult target to hit; attackers are -6 to strike. The astral body also has an S.D.C. two times greater than the hit points and S.D.C. of the physical body combined. This means if the character has 18 hit points and 28

S.D.C., both the astral body and its silver cord have 92 Astral S.D.C. each ($18+28=46 \times 2=92$ each). Remember, magic and psychic influence have full effect on the astral body. This includes exorcism, which will force the astral traveler to leave the immediate area (400ft radius) and not return for 24 hours. The astral traveler has the same number of attacks per melee, bonuses, hand to hand, skills, knowledge and psychic powers that he or she has in the material plane.

Entering the astral plane is like entering the twilight zone. After a minute of concentration, the astral gateway appears as a bright patch of shimmering, white light. Once the astral traveler passes through it, he will find himself in an endless expanse of white light, and rolling, white clouds. There is no up or down, no bottom or top; no north or south, no land or air or sea, just endless, slowly swirling white. Time too, is a different or altered state, for what would seem to be a week in the astral plane is barely one minute in the physical world. Time and space twisted and distorted, the astral traveler can travel from one end of our planet to the other, in the blink of an eye, by hopping through the astral plane. While this may sound wonderful, the astral plane has its dangers as well. **First**, the distortion of place and time makes it extremely difficult to find the material world and one's dormant, physical body. Even trying to follow the silver cord can lead to nowhere.

To return from the astral plane to the physical body, roll on the following table: Each roll will determine the astral traveler's state of mind and sense of direction. The percentile dice can be rolled up to three times per melee (15 seconds). The player must roll "definitely certain" to successfully return. The player may keep trying until he succeeds or time elapses.

Location of the Physical Body

Roll Percentile Dice to Return from the Astral Plane

1-30 Hopelessly Lost (roll again).

31-50 Uncertain, confused (roll again).

51-76 Fairly certain of location; on the right track (roll again).

77-00 Definitely certain of location. (Whew! Made it Back).

- Astral travel with a *partner* is a much safer way to travel, because if one can find his body, he can lead the other one out with him.

Note: Traveling on the material plane in astral form is infinitely easier than the astral plane. To find the physical body, the character need only return to where he left it. If it has been moved or hidden, the astral self can sense its location with a 60% efficiency (roll once per melee).

The other danger lies in being attacked by other beings in the astral plane. Entities and elemental creatures of magic live in the astral plane or travel through it. These beings are usually hostile, evil forces. While the astral body can not touch or communicate with the material world, the astral body is quite solid to other inhabitants of the astral plane. The astral body is also vulnerable to magic and psychic powers, as well as physical assault by astral entities.

The energy which composes the astral plane is responsive to thoughts and desires. The strongest astral beings can mentally or magically control what a small area might look like. This means that the astral plane is made up of hundreds or perhaps thousands or even millions of tiny astral "kingdoms" adrift within the vast whiteness. Exactly what these kingdoms look like is up to the entity that creates it. Some may look like a modern city,

other castles or forests, while still others, a frightening landscape. Perhaps this is where legends of visitations to heaven and hell originate? It is always wise to avoid an astral kingdom, because only the most powerful entities and astral beings can create and maintain them. In Professor Victor Lazlo's book, "Worlds Within Worlds," he provides us with this firsthand account of astral travel:

"Although I myself have only minuscule psychic abilities, what might be considered a latent psychic (very latent), I had never been able to achieve astral projection. However, lord, high priest Vish-taal assured me that he could help me achieve the reputed state and lead me into the astral plane. So I bravely began my excursion into the ethereal realm that coexists with our own. After nine days of fasting, consuming only herb broth prepared by Vish-taal once per day, I was ready at last. We meditated together for three hours then, before I realized it, I was looking down at my own body. The sensation must be akin to floating in the weightlessness of space. The room seemed somewhat out of scale and distorted, like looking through a fish-eye lens. Suddenly I realized Vish-taal was floating next to me. He assured me that all was well and that after a few more out of body experiences I could see the material world as clear as normal. But today our goal was the astral plane. He took hold of my shoulder and beckoned me to come. With that, we both rose upward through the ceilings of the next three floors, the roof and skyward. I must confess that my 23 years as an investigator of the paranormal had not prepared me for this experience. All my professional cool had fled me the moment I left my body. I was so enthralled with the events and images that without the guidance of Vish-taal I would have bobbed about the room like a dumfounded child seeing Disneyland for the first time. Everything seemed to sweep by me, stealing my full attention for that moment, giving away to the next sensation and the next. As I sped skyward at a speed I can not begin to guess, the sparkling body of my astral guide caught my attention. For the first time, I noticed that our astral bodies were aglow with a bright, translucent, blue-white light with countless tiny flashes of white, yellow, and blue light, like a thousand microscopic strobe lights set for a slow pulse. A thread of translucent silver unreeled itself as we rocketed ahead. Vish-taal yanked my attention with the words 'the gateway'. Before us was a glittering wall of light which we plunged through at great speed, without pause. Suddenly we were plunged into a world of swirling white, broken only by wisps of white clouds. There was no longer any sense of up or down. Direction had no meaning. Without my astral guide to calm me I would have become lost in the vastness of the white infinity. Vish-taal assured me that with training one could sense the material world and use it like an invisible compass. I must admit that after what seemed to be about a half hour, I was able to discern shapes and patterns in the endless white clouds and mists. A strange calm seemed to take hold of me and made the whiteness seem far less alien. Then, after a long while, appearing through a fog-like mist stood a forest. Shades of green and brown and grey leaped out of the whiteness. A blue sky broken by cumulus clouds radiated around the green. Without realizing it, I had automatically gravitated toward the oasis of color. Suddenly, a sensation of evil shot through me like a hundred burning needles. Never in my experience as a minor psychic sensitive had I ever felt such hatred, such loathing. To my left a billow of grey and black storm clouds began to roll out from the green

trees. The blue sky darkened and the clouds shot toward me with an anger I can not describe. Vish-taal's voice echoed in my ears: Go now we must, Victor. We should not try battle with this one. Now Victor, away from the dark. Flee with me and look not back.' We sped through the white and I did not look back. Obviously, I survived to tell this tale. When we returned to our physical bodies, I was still shaking. Vish-taal smiled knowingly and said, Victor, you see much adventure this day. I will send food while you much relax.' With a wink, the old yogi left me with my own thoughts.

"The experience seemed to last several hours. I would hazard to guess eight or nine. Yet the wall clock confirmed with my wristwatch that less than six minutes had actually elapsed. Did I experience astral travel? Or was it sensory deprivation? The wily old priest could have easily drugged my broth or even hypnotized me. I had seen him expertly use hypnosis on others on countless occasions. But the old man and I had been friends for years and I honestly don't think my mentor would deceive me. So this then was the astral plane. I wish I could relate the details with greater clarity, but as I said, my objectivity and skills as an investigative reporter deserted me. One thing that did strike me was how much my astral plane experience seemed to mimic the transmissions of Lt. Taylor from Flight 19, which disappeared in 1945 over the Bermuda Triangle. In that celebrated and much disputed case, five Air Force Avenger Torpedo Bombers disappeared during a routine flight near Ft. Lauderdale, Florida. The leader's (Lt. Taylor) radio transmissions were bizarre. He reported that both compasses were out, and on a fairly clear winter afternoon, could not find Ft. Lauderdale. Other transmissions speak of vast whiteness and swirling clouds. Of not being able to find the sun or ascertain any sense of direction. Not even up or down. The transmissions faded in and out until they stopped. The final transmission: "We'll fly west until we hit the beach or run out of gas." Flight 19 disappeared without a trace. The most logical explanation is that the five aircraft perished in a sudden squall; not that any storms were known to have arisen that afternoon. Is it possible that some mysterious force opened a portal into the astral plane? A portal that the five bombers, and a sixth search aircraft and its crew of thirteen, inadvertently flew into? It is a possibility I must investigate further."

Excerpted from Victor Lazlo's WORLDS WITHIN WORLDS, 1977.

Clairvoyance

Range: Self (although the image could pertain to people or places thousands of miles away).

Duration: 6D6 melees

I.S.P.: 4

Base Skill: 58%+2% per level of experience.

This allows the psychic to see or feel glimpses of the possible future. This is achieved through meditation or intense concentration in which the clairvoyant thinks about a particular person, event or place. Add +5% to the base skill if the person involved is a friend or loved one. Clairvoyance is unpredictable and can not be turned on and off like a light bulb. Sometimes it works (if the roll is under the base skill) and sometimes it does not (when the roll is above the base skill). A failed roll means the psychic received no insight to the future.

A clairvoyant trance can be attempted as often as *twice every day*. The message can be a sudden feeling that somebody is in need (“something’s wrong. It’s Janet! I’ve got to see her!”) or, more often, a sudden flash of insight, a sudden image that races through the mind. The image is like a brief snippet of film from a movie or a dream. Often all the details are not clear, but the potential danger is. For example, “The psychic character is in a trance or meditation, thinking about his/her friend Janet. Suddenly, the mind is flooded with an image of Janet rushing down a crowded street. It’s dusky, like morning, twilight or evening. She seems very upset. The traffic light changes to amber. Janet races into the street, ignoring the light. It turns red. There’s a car, squeal of tires, Janet screams. The image ends. Is Janet hurt? Killed? Unknown, but the danger is clear. There are also other hints of information: the time of day, Janet seeming upset, rushing, etc. The glimpse into the future could be twenty minutes, eight hours, 24 hours, or a week. The psychic has no way of knowing. Of course, he has the advantage of recognizing the potential danger as it begins to unfold and may be able to avoid it, stop it or change the outcome. The image may last a few minutes or be a sudden flash lasting but a few seconds. The flash could be a peculiar noise, a face, or a specific image, like a particular door or object.

It is important to note that sometimes a clairvoyant image will occur unintentionally, without the psychic trying to do so. These most often manifest themselves as dreams or nightmares during sleep. The clairvoyant dream is exactly like the image from a meditative trance described previously. The precognitive flash of the future may also occur unbeckoned while awake, but this is extremely rare. These brief glimpses of the possible future happen because the clairvoyant is acutely attuned to his world. Anything that might hurt or change that world (including people and places) will often be foretold in a flash of insight.

Game Masters: Be careful of revealing too much. Use the examples provided as a guide. Remember, these are brief glimpses of the possible future, not a motion picture. The psychic can NOT engage in any actions, combat or otherwise, during a moment of clairvoyance or the image will instantly stop. It usually requires 2D4 melees of concentration or meditation before the image occurs. Remember, a failed base skill roll means absolutely nothing happens, but still burns up the 4 I.S.P. and the time.

Death Trance

Range: Self

Duration: As long as the psychic senses he must feign death, up to a maximum of four days.

I.S.P.: 2

A state of mind over matter that slows the metabolism to such a degree that it creates a temporary state of suspended animation, simulating death. Without hospital facilities, even a medical doctor is likely to believe the character is dead (1-89% likelihood). The effects of drugs, toxins and chemicals are slowed to a crawl, doing damage or effect, but will take full effect the instant the death trance is stopped (unless treatment is administered first). While in the death-like state, the psychic cannot be roused or respond to any type of stimulation, including psychic probes. This means he is incapable of attacking or defending himself in any way until the trance is broken.

Divination

Range: Self

Duration: 2D4 minutes

I.S.P.: 3

Base Skill: 42%+2% per each additional level of experience.

Divination is a *precognitive* ability to sense the future. Throughout the history of the world there have been fortunetellers who claim to foretell the future by reading tarot cards, sticks, palms, tea leaves and other things. This precognitive power is much less accurate and detailed than clairvoyance. With divination there is no image, no sound, no tangible memory or flash, only an impression.

To perform a divination, the diviner must meditate for at least 15 or 20 minutes. The tools or item(s) read by the fortuneteller are laid out/spilled before the psychic, their random patterns providing *hints* to the future. No specific questions or details can be revealed, such as, “Yes, if you go to the house this evening you will be attacked by a madman and murdered with a knife.” Instead, what *might* be revealed is something like, “I see the specter of death. It waits hungrily. I see violence and yes, madness.” or “Death awaits you at the house.” Neither says that the character will be killed, but does confirm that somebody or something may be out to kill him. This is the way divination should work, small *impressions* of the *possible* future. **The game master** should never predetermine the outcome of a game or an event within a game. Like real life, there are too many x-factors which can change what may seem inevitable. Consequently, keep the divination answers a bit general to give yourself maximum flexibility of play. NEVER make a situation completely hopeless!

The diviner can try to divinate his own future, but with a -10% skill penalty, or the future of ONE person at a time. **The person can ask** up to 13 questions which the diviner will try to answer. The divining character must roll percentile dice for each question. **A failed roll** means he senses *nothing* and cannot answer the question. Professional fortunetellers will make up some intriguing line of malarkey like, “The wheels of the future are always turning. Too many things could influence your future in this regard (in answer to the question). Proceed with caution.” or “Something blocks my vision. I can tell you nothing.”

There are all types of methods and items of divination. The psychic’s personal orientation/focus must be limited to one or two types. Select one (or two maximum) focuses/objects needed for divination. **Note:** The character cannot see into the future without using the item(s).

DIVINATION FORMS TABLE

ARITHMANCY: The use of numbers, either in patterns which reoccur around the person or selected randomly, to tell their past or predict their future. See also Numerology.

ASTRAGALOMANCY: Divination by the use of dice or marked pieces of bone. This technique includes modern dice, the Viking system of “casting the runes” and the casting of human and animal knucklebones used by African witch doctors.

BELOMANCY: Foretelling the future by throwing arrows to the ground and observing the pattern they form. This particular technique would be well suited to primitive or modern, bow-using cultures.

CARTOMANCY: This form of divination is done literally by the “turn of a card.” It uses special decks of cards, known as

Tarot, but can also be done with a regular deck of playing cards. Each card is ascribed a specific meaning and are laid in a pattern. Meditation on the cards and the pattern they form give the divination. Cartomancy has always been one of the most popular kinds of fortunetelling and has existed from the time of the Pharaohs of Egypt.

CEPHALOMANCY: This divinatory skill uses the bumps and depressions which can be found on a person's skull to predict their future. It is vaguely related to palmistry in that the person's entire future is supposed to be written on their body.

CHIROMANCY: Also known as palmistry, this art teaches the user to read the future in the lines found in the palms of the questioner's hands. Each line is supposed to govern one particular area of life, including Life, Love and Fortune.

CRYSTALOMANCY: Another very common form of divination, this technique uses a crystal ball as an aid for seeing into the future. There are many arguments among experts as to whether the answers/visions actually appear within the crystal or just within the mind of the seer, who uses the crystal only as a focus.

EMPROMANCY: This is divination by the studying of objects placed in a sacrificial fire, especially as to any shapes or forms seen in the smoke or the fire itself.

GEOMANCY: Divination by tossing pebbles on the ground and analyzing the pattern they form. The pebbles can either be special ceremonial stones, or they can simply be a handful of stones picked up on a beach.

HYDROMANCY: This skill requires the use of a small pool of water in which the seer analyzes the ripples and other disturbances of the pool itself.

ICTHYOMANCY: Very popular in cultures which depend upon fish for existence, this is divination by the examination of the entrails of a fish.

KLEIDOMANCY: By suspending a pendulum over an alphabet and asking questions, the pendulum is supposed to spell out the answers. A cousin to this skill today is the modern Ouija board.

LECANOMANCY: One of the most beautiful and most expensive of the divinatory arts, gems are dropped into still pools of water and the ripples they create are analyzed for hints about the future.

MOLYBDOMANCY: This is divination by observing the pattern formed by molten lead after it has been dropped onto a smooth surface.

NUMEROLOGY: A very popular form of divination for the last hundred years or so, this art analyzes numbers connected to a person's name and date of birth, using a very stringent system for reducing alphabetical names to numbers.

PESSOMANCY: This is divination by observing the size, shape, texture, etc., of a pebble drawn randomly from a pile.

PHYLLORHODOMANCY: Taking literally the old saw that each flower carries a message, this technique analyzes the pattern formed by the petals and leaves of a rose to divine the future.

PYROMANCY: According to the practitioners of this technique, by analyzing a fire, paying special attention to the flames and any smoke or sparks, the future can be told.

TASSEOGRAPHY: This is the reading of tea leaves; a specialty of old women in tea houses and restaurants around the world.

XYLOMANCY: This technique analyzes the pattern of spikes thrown on the ground. Somewhat related to Belomancy, the best known example of this system is the Chinese "I Ching," or Book of Changes, system.

Empathy

Range: 100 foot area (30.5 m)

Duration: Two minutes (8 melees) per level of experience.

I.S.P.: 4

Saving Throw: Standard; a save vs empathy means the psychic can not get a clear sense of the emotions of that particular person. To save vs empathy the person must roll to save once each melee. Mind block will prevent any empathic emanations from the blocked person.

Empathy is a psi-ability that makes the psychic aware of, or feel, the emotions of other people, animals and supernatural creatures. The strongest emotions are easiest to sense: hate, anger, terror, love. Feeling for emotions can often be used to establish that somebody or something is nearby, but can not be used to pinpoint an invisible or hiding person/creature. Empathy can be especially helpful in recognizing and communicating with ghosts and other supernatural creatures.

Questioning a person/being while using empathy can be very handy in establishing how they are reacting to you. In a limited sense, empathy can be used like a lie detector to see if the emotions match the verbal response. For Example: "Did you know the deceased?" The verbal answer is no, but there is a sudden flare of nervousness and fear (or hate). This doesn't mean the guy is the killer, but it might mean he is lying about knowing the dead man. Further questions might pull out a strong emotion such as anger or hate (or happiness), which may confirm the psychic's suspicions that this man might be involved in the murder. However, remember that this is, at best, circumstantial evidence and definitely inadmissible in court. Physical proof must be found, but the empathic readings may put characters on the right track. Also, remember that the empathic psychic is feeling the person's real emotions, not interpreting their significance. A very nervous person may always radiate fear or anxiety, while a cold-blooded, pathological killer may feel nothing at all and stay calm and cool as he lies through his teeth. The feeling of hate may mean that the person did know the murder victim, or knew of him, and hated him for any number of reasons. That does not mean he killed him. As you can see, interpreting emotions can be a tricky thing.

Haunting ghosts and entities rarely mask their emotions. Thus, the psychic can easily tell if one or more is nearby (within 100 feet/30.5 m) and what it is feeling. "I sense great sorrow." or "Do as it says! It is angry, almost crazed. I think it will carry out its threat if you try to stop it."

Empathic Transmission

Range: 60 feet (18.2 m)

Duration: 2D6 minutes (2 to 12 minutes)

I.S.P.: 6

Attacks Per Melee: Equal to the individual's psychic abilities; usually 2 or 3 psi-attacks per melee.

Saving Throw: Standard

This incredible ability enables the psychic to instill a powerful emotion into another living creature; person, animal or supernatural being. Each psychic attack/transmission can only affect one creature at a time. Several supernatural creatures have this ability or some aspect of it.

Despair or Sorrow: Invokes great emotional upheaval, deep sorrow and a sense of loss. There is a 50% chance of the victim surrendering or leaving without a battle; furthermore, victims are -2 to parry and dodge.

Confusion: Disorients the person so badly that he has no sense of direction, time, or of what is exactly going on. Victims are -3 to strike, parry and dodge, and lose initiative in any combat.

Fear: Invokes unreasoning terror in all those affected. Victims are -3 to strike, parry and dodge, plus there is a 66% chance that those affected will turn and run.

Hate or Anger: Will prompt those affected to act rashly, charge, attack, argue violently, etc. Victims are likely (60% chance) to attack, kill, harm, or betray those they dislike; +1 (yes, that's plus) to strike, -1 to parry and dodge.

Love or Peacefulness: Will induce a deep feeling of serenity, dispelling anger, hatred, sorrow, and so on. Hostile opponents are likely (60% chance) to reconsider their actions, deciding not to attack, show mercy, leave without being overtly cruel or destructive, halt a rampage, and so on. It does NOT make its victims docile sheep, but curbs hostility.

Trust: Will make its victims believe everything the psionic tells them, but only while under the empathic influence. Life threatening suggestions that go against deep-seated fears or ideals provide an additional savings throw against the suggested action; with a bonus of +3 to save.

Meditation

Range: Self

Duration: Varies with the person's needs.

I.S.P.: None

Meditation is the only ability that can be done at any time and costs no I.S.P. to perform. Meditation is not so much a psychic power, as it is a mental discipline. The character meditates by dwelling upon a single notion, mental object, or mantra (a repetitious chant or humming), to achieve a deep relaxation, focus, or to gain insight and harmony into one's inner self, nature and the universe. Meditation is often required to use psychic and magic powers.

Mediumship/Clairsentience (Seance)

Range: Self

Duration: 2D4 minutes (plus 3D4 minutes of preparation)

I.S.P.: 4

Base Skill: 30%+2% for every P.P.E. point that can be drawn on.

Some individuals are especially sensitive to psychic impressions and can open themselves to the supernatural forces. The clairsentience power operates on two levels. **First:** The psychic sensitive acts as a beacon, *calling* out to haunting ghosts or other entities. This makes the psychic's presence known, as well as invites the entity(s) to come forth and communicate.

Second, the psychic acts as a *medium* through which the entity can speak (temporary possession) or as the mediator (the person who asks the questions). As the mediator of a seance group, someone other than the psychic beacon is temporarily possessed, but only the mediator can ask questions. The spirit or entity will temporarily enter the medium or psychically susceptible member of a seance group to communicate. The voice is often the voice of the spirit force, not the person, and might be in a foreign language. The entity may not speak at all, but write or draw its message. Communications are usually brief, seldom lasting more than five minutes and ending abruptly. The entity is *not* bound to answer questions truthfully, although good alignments have no reason to lie (evil entities lie freely). The person selected as the "mouthpiece" will remember nothing that occurred while possessed. If the person has latent psychic powers or many P.P.E. points, the possessing force will be able to draw on that energy reserve to create other phenomena such as telekinesis, empathic transfer, etc. The spirit's words and actions can not be controlled, making physical manifestations all the more frightening. This accounts for gusts of wind, rapping, table movement, etc. Fortunately, the possession is short-lived, or contact can be broken by breaking the chain in the seance.

The seance chain is composed of a group of people who sit, holding each other's hands to create a circle. The group can be a mere two people or as many as a dozen. It is pointless for the psychic medium to open himself up to a seance without at least one other, because he can not remember what happens while under the control of the entity. Another reason for having several people is that each person can feed the medium with their own potential psychic energy (P.P.E.). Each person in the seance chain can temporarily contribute up to half of his/her P.P.E. to the cause. The only requirement is to truly desire communication with a supernatural force. Each *supporter* of the communication link adds P.P.E. fuel. Each P.P.E. point increases the bases skill by +2%. The psychic medium can draw on all of his P.P.E. points, which is usually 8 or 10. Every P.P.E. point from a person *opposed* to the communication reduces the success ratio by -2%. A *nega-psychic* who is a member of a seance chain will reduce the success by -4% per each of his P.P.E. points. However, the *nega-psychic* can *observe* a seance without any ill effects. The use of the P.P.E. energies is momentary and returns to full level within minutes, but may leave some participants with a slight feeling of dizziness or fatigue for those few minutes. The seance can be broken at any time by letting go of each other's hands. **Game Master's Note:** The behavior of the ghost or entity that communicates through the medium will depend on the type of entity, its alignment and its plans. Many haunting ghosts want help if they can get it, while poltergeists are pure mischief. The more powerful, evil entities may mislead or mock the characters, or even lash out during a seance, using the participants' own P.P.E. against them. However, a seance assault is usually more frightening than deadly. The spirit force can communicate in voice, writing, symbols/drawings, or sometimes with telepathy or empathic transfer as well. A brief gust of wind often whips up out of nowhere, small objects are knocked over or rattle about, the table may move or levitate as much as two feet above the floor and another psychic may sense the entity's emotions. The most sensational and violent seances may produce hurling objects which can inflict minor physical damage to the seance participants, ectoplasmic apparitions, empathic transmis-

sions (usually fear, confusion or despair) and even magic spells/assaults. Regardless of the strength and ferocity of the creature's response/onslaught, the seance can *always* be instantly stopped by just one person breaking the chain of holding hands. The moment somebody lets go, the mini-circle of P.P.E. power is broken and the entity is dispelled from the host medium's body. At that same instant, all physical and mental manifestations cease.

In the case of non-psychic seance attempts (ordinary people without the aid of a professional psychic or medium), the base skill is equal to the number of P.P.E. points linked by the hand holding. The person with the most P.P.E. or one with latent psychic abilities is the likely one to be selected by the entity to communicate through.

Mind Block

Range: Self

Duration: 10 minutes per level of experience.

I.S.P.: 4 (per each duration period)

This is the ability to completely close or block oneself from all psychic/mental emanations. When intentionally closed to supernatural or psychic forces, the character can not sense anything, can not use psychic abilities, nor be influenced by others. A mind block will prevent penetration of telepathy, empathy, hypnotic suggestion, and empathic transfer. It can be an invaluable protective mask when dealing with malevolent psychic forces. Adds a bonus of +1 to save vs all psychic and mental attacks.

Object Read (Psychometry)

Range: Touch

Duration: Varies; usually about 2D6 minutes.

I.S.P.: 6

Saving Throw: None

Base Skill: *Impressions:* 56%+2% per level of experience. *Images:* 48%+2% per level. *Present:* 38%+2% per level of experience.

This uncanny ability enables the psychic sensitive to receive impressions and images from an object regarding its use, history and last owner. This is done by holding the object and concentrating on a specific line of thought or opening up to general impressions (the latter is always more vague and random). Just as a psychic must open himself to sense evil or magic, he must open himself to the object. If successful, he will receive impressions and/or images revealing bits of information.

Impressions include: General alignment of its last owner (good, selfish, evil), general emotional state of mind (anger, happy, sad, hate-filled, confused, etc.), the object's general purpose (what it is used for), whether or not the last owner is living or dead, and whether the item has been used with/by magic or supernatural forces. Object read will also conclusively indicate whether the item is currently enchanted or contains a supernatural force/entity (as well as *its* alignment and emotions). If the item *is* possessed, an object read makes the reader totally vulnerable to psychic attack (no bonuses to save).

Images: The psychic can also see images of isolated events which have happened in the past. This will provide brief *snippets* of images and events that will offer glances of the previous

owner and others close to him. Traumatic and emotion filled events/images are the easiest to see. Impressions will accompany the images, adding to the story as it unfolds. *Information includes:* approximate age, height, weight, build, race, sex, sometimes occupation, hair color and length; special facial or body features, such as a scar or tattoo or beard (very often the exact facial features are out of focus, blurred or obscured); the object's use/purpose; and some special event, usually very traumatic, important or happy. Often the event image will be fragmented as if it was a piece of movie film edited by a crazy man. The event will always be one in which the object was involved in some way.

The present can also be glimpsed, but costs an additional 4 I.S.P., with no guarantee of success. Sometimes the psychic can focus in to see and feel the last owner as he or she is at that very moment. This will provide an idea of what is his current state of mind/emotion, appearance/dress, general location (that is to say, a bedroom, office, street, outdoors, etc. No address or sense of close or far is provided), general features (shaved his beard, dyed hair, etc.) and so on. The psychic may be able to identify a place or person by feature, if he has seen it before or runs into it/him in the near future.

The success or failure of an object read: roll percentile dice once for impressions and once for images. The roll must fall under the character's base skill ability to succeed. A roll higher than the base skill means a failure and the psychic feels and/or sees nothing. Impressions and images are two different things, so *roll for each*. The psychic may get no impressions, but see images or vice versa. The present can *not* be seen unless the psychic was successful on at least one of the previous read impressions or images rolls. Once an object has been read it can *not* be read again by the same psychic, even if he did not see or feel a thing. Of course, the psychic can attempt to object read other items, but each attempt will cost 6 I.S.P.

Presence Sense

Range: 120 foot/36 m area

Duration: 2 minutes (8 melees) per level of experience.

I.S.P.: 4

Saving Throw: None

Presence sense is a sixth sense which will alert the character to the presence of supernatural and magic creatures in the area. The ability can not pinpoint the location of the presence, but will give the psychic the impression of whether it is near (within 50 feet/15.2 m) or far (beyond 90 feet/27.4 m). It will also give the character a vague idea of how many presences there are; one (1 or 2), a few (3 to 6), several (7 to 14), or many (15 or more). The psychic can also sense human presences, but with much less accuracy. It is more of a feeling of "We are not alone." The person's distance is undeterminable and the number of people is limited to a sense of one or two or many (and that is only right 50% of the time).

See Aura

Range: 60 feet (18.3 m) and must be visible.

Duration: 2 melees (30 seconds)

I.S.P.: 6

Saving Throw: None, but a mind block will hide the presence

of psychic abilities, the level of P.P.E., and possession by a supernatural force.

All things, organic and inorganic, have an aura. The aura has many distinctions and can be used to see or sense things invisible to the eye. *Seeing an aura will indicate the following:*

- Estimate the general level of experience. Low (1-3), medium (4-7), high (8th and up).
- The presence of magic (no indication of what or power level).
- The presence of psychic abilities.
- High or low base P.P.E.
- The presence of a possessing entity.
- The presence of an unusual human aberration which indicates a serious illness, non-human, or mutant, but does not specify which.

Note: Can not tell one's alignment from "see aura."

See The Invisible

Range: 120 foot/36 m distances.

Duration: 1 minute per each level of experience.

I.S.P.: 4

Saving Throw: None

The character can see forces, objects and creatures which can turn invisible or are naturally invisible. Even if the creatures have no form per se, the psychic will be able to discern the vaporous image or energy sphere which is the being. This includes ghosts, entities and the astral body.



Sense Evil

Range: 140 foot/42.7 m area.

Duration: 2 minutes (8 melees) per level of experience.

I.S.P.: 2

Saving Throw: None

This psi-power is a much more refined ability to feel the presence of evil. All supernatural creatures radiate their alignment, good or evil. A psychic sensitive will automatically feel supernatural evil without spending a single I.S.P. However, to get a clearer picture of the evil force(s) the character must open himself and use the sense evil ability.

The sense evil psi-power will indicate the general number of *supernatural evil*: one, a few (2-6), several (7-14), or many (15 or more). It can also register the intensity of the evil and pinpoint the general location of the source(s) to a particular room(s), possessed object or person, or distance; i.e. very near (within 15 feet/4.5 m), near (within 50 feet/15.2 m), or far (60 to 140 feet/18.2 to 42.7 m). The character can track the source of supernatural evil, like a bloodhound, by sensing how close it is to him.

Evil emanations from human beings are much less distinct and can *not* be felt unless the source-person has an immediate evil intention and has psychic powers or is psychotic. The former can mask his evil intentions with a mind block.

Sense Magic

Range: 120 foot/36 m area

Duration: 2 minutes per level of experience.

I.S.P.: 3

Saving Throw: None

The ability to sense magic is much like the sense evil psi-power. The psychic can feel magic energy, tell whether it is near (within 20 feet/6.1 m) or far (up to 120 feet/36 m away) and follow the emanations to pinpoint their source as a particular place, room, person or object. **Note:** Invisible, magical supernatural creatures or objects can only be traced to a general area, like a specific room or corner. The psychic will also be able to sense whether or not an object has magic powers, if a person or item is enchanted/under a magic spell (this does *not* include psychic powers), when magic is being used within the area (120 feet) and when a person is casting a spell (users of magic do *not* radiate magic energies until they call upon them).

Sixth Sense

Range: 90 feet/27.4 m

Duration: Until the danger passes or happens.

I.S.P.: 2

Saving Throw: None

The sixth sense is a power that gives the psychic a precognitive flash of imminent danger to himself or somebody near him (within 90 feet/27.4 m). The character will not know what the danger is or where it will come from, nor who it will be directed at when in a group. All he will know is that something life threatening will happen within the next 60 seconds (4 melees)! The sixth sense is triggered *automatically*, without the consent of the psychic, whenever his life is in great peril or the life of somebody he greatly cares about (friend, loved one, etc.). The sixth sense is only triggered by an *unexpected, life threatening* event which is already set into motion and will happen any second. The power *can not* be called upon at will to sense for traps or ambush. Instead, it works like an automatic reflex. If the character has used all his I.S.P. the sixth sense is temporarily rendered inoperative.

Bonuses:

The sudden flash of insight provides the following bonuses. All bonuses apply only to the initial *melee* when the attack occurs.

+6 on initiative roll

+2 to parry

+3 to dodge

The character can not be surprised by a sneak attack from behind.

Speed Reading

Range: Self

Duration: 3 minutes per level of experience.

I.S.P.: 2

This is the ability to read and comprehend the written word extremely quickly. Speed of reading is 30 pages per minute/4 melees. The psychic will retain the information as he would normally. Highly technical texts will reduce the speed reading by half (15 pages per minute) and may require two readings.

Suggestion (Hypnosis)

Range: 12 feet/3.6 m, with eye contact.

Duration: Varies with each circumstance and subject; rarely more than a few hours maximum.

I.S.P.: 2 per idea or attempt to implant an idea.

Saving Throw: Standard

The power of suggestion is a psychically boosted form of simple hypnosis. The power is limited to relaxing/calming somebody down, putting a person or animal in a light sleep, helping a person to relax and focus on a particular thought (good for helping someone to remember things) and implanting subtle ideas. The implanting or "suggestion" of an idea must be subtly worked into a comment. The suggestion must be kept simple and clear, such as "You know you can *trust* me" or "You feel like you *have a fever*. Yes, you do have a *fever*. You're burning up (with *fever*). You should *lie down*." or "You don't want to go there." The power of suggestion can also be used to make the victim imagine sounds and images. "Did you hear that? Listen! *Footsteps!* You hear the *footsteps*, yes, you do!" Or, "At *midnight the specter appears*. Everybody who is ever present *sees the specter at midnight*." The poor individual who fails his saving throw will, indeed, imagine he sees something at midnight.

The power of suggestion can *not* make a person think he's a chicken, nor does it make a person the psychic's charmed, zombie slave that obeys his every command. It simply soothes or implants a notion into someone's thoughts. Sometimes that little bit can be an important edge.

Note: A successful save against a suggestion means the idea is not implanted. The psychic may try again (at the cost of another 2 I.S.P.).

Summon Inner Strength

Range: Self

Duration: 10 minutes per level of experience.

I.S.P.: 4

This psi-power enables the character to draw on his inner reserves of strength to ward off pain and fatigue. Every time the psychic calls upon his inner strength, the following bonuses apply:

- Add +10 S.D.C.
- Add +2 to save vs poison or toxins.
- Add +5% to save vs coma/death.
- Fatigue is temporarily forgotten and the character can function as if he was fully rested for the full duration of the summon inner strength power.

Telepathy

Range: Read surface thoughts up to 60 feet/18.3 m away or two-way telepathic communication — 140 feet/32.7 m.

Duration: 2 minutes per level of experience.

I.S.P.: 4

Saving Throw: Conditional. When a person suspects that he is being telepathically probed he can resist, getting the *standard* saving throw. Mind blocks will completely prevent telepathic probes or communications as long as the block is up.

The power of telepathy allows the psychic to eavesdrop on what a person is thinking at a particular moment. This is done by focusing on that one person and picking up on his or her surface thoughts. *Surface thoughts* are those thoughts and musings uppermost in a person's mind. A deep probe into memory is not possible. Although the psychic can read the thoughts of several people, he can only do so by focusing on *one* person at a time. Simultaneous, multiple mind reading is impossible for the character.

Limited telepathic communication is also possible. The telepath can *send* a directed thought message to one person at a time. The message must be as brief and clear as possible. Like, "John, I need you immediately. Hurry!" or "Stop! Don't do that." "Come here," "Look Out" or "Press the green button." However, two-way telepathic communication is not possible except between two telepathic psychics.

Total Recall

Range: Self

Duration: Permanent

I.S.P.: 2

The character remembers every word he reads. Specific blocks of information can be recalled in perfect detail at will. Each block of information costs 3 I.S.P. to recall in absolute detail. If all I.S.P. have been expended the memory is a little fuzzy, so that exact quotes and details may be impossible to recall. Roll percentile: 1-50 — remembered in full detail, word for word; 51-80 — details are forgotten, but the full essence of the ideas are clear; 81-00 — can only recall the most basic concepts; no details nor strong comprehension.

PHYSICAL PSYCHIC ABILITIES

Alter Aura

Range: Self

Duration: One hour per each level of experience.

I.S.P.: 2

Saving Throw: None

A truly unique power that many psychic investigators claim is impossible and does not exist. Only a handful of physical psychics can manipulate their physical energy in such a way that it changes their aura. The altered aura will send the wrong message to those who can see auras. Alterations include:

- General level of experience can be made to seem much lower (level 1 or 2) or much higher (2D4 levels higher) than it really is.
- Conceal the presence of psychic powers.
- Conceal level of base P.P.E. (made to seem much lower).
- Conceal the presence of magic.



Bio-Manipulation (the evil eye)

Range: 160 feet/48.8 m

Duration: 4-16 minutes (roll 4D4)

I.S.P.: 10

Saving Throw: Standard

The psychic is able to induce physical trauma to the nervous system of others by sheer force of will and psychic energy. This psi-power is often known as “the evil eye.”

There are seven types of bio-manipulation effects. Each affects only one person per attack and can be used in any combination. Intended victims must be within line of vision or their exact location known to the psychic. Each costs 10 I.S.P. to inflict.

This psychic power enables the psychic to temporarily manipulate specific biological functions or conditions in human and animal life-forms. *The duration can be extended 4-16 (4D4) minutes per additional 6 I.S.P.*

Blind: Temporarily knocks out the victim’s optic nerves, rendering that person quite helpless. Victims are -9 to strike, parry and dodge.

Deafness: Can be caused by manipulating the eardrum. Victims cannot hear anything, and are -6 to parry or dodge attacks from behind. In addition, the shock of suddenly becoming deaf makes them -3 to strike, parry or dodge any other attacks, and they automatically lose the initiative on all attacks.

Mute: Impairs the victim’s vocal cords, making speech impossible. Victims are likely to be shocked and panic, making them -2 to strike, parry and dodge for the first melee ONLY.

Pain: By manipulating the nerve centers, the psionic can induce terrible pain, shooting throughout the body. Victims are -6 to strike, parry, and dodge, and take one point of damage off their hit points (not S.D.C.) per each minute affected.

Paralysis: Immobilizes the motor part of the brain, causing legs and arms to stop functioning. Victims are completely incapacitated for the duration.

Stun: This attack disorients and confuses its victims. Victims forfeit one attack per melee, speed is cut by half, and are -4 to strike, parry and dodge.

Tissue Manipulation: Affects the tissue’s connecting nerve fibers which can cause a variety of effects. By irritating the nerve fibers a victim will suddenly feel itchy, as if suddenly breaking out in a severe rash. Through endothermic manipulation, the victim can be made to suddenly feel cold or hot while everyone around him feels fine. This is done by manipulating the body chemical which absorbs heat. ALL three conditions are more annoying or frightening than physically impairing. In each case the victims are -1 to strike, parry and dodge.

Saving Throw: Standard; if a character successfully saves against the attack he is not affected at all. This applies to all seven bio-manipulative attacks.

Death Trance

Range: Self

Duration: As long as the psychic senses he must feign death, up to a maximum of four days.

I.S.P.: 1, (It’s easier for the physical psychic to control his body, because that’s the focus of his powers).

A state of mind over matter that slows the metabolism to such a degree that it creates a temporary state of suspended animation, simulating death. Without hospital facilities, even a medical doctor is likely to believe the character is dead (1-89% likelihood). The effects of drugs, toxins and chemicals are slowed to a crawl, doing damage or effect, but will take full effect the instant the death trance is stopped (unless treatment is administered first). While in the death-like state, the psychic can not be roused or respond to any type of stimulation, including psychic probes. This means he is incapable of attacking or defending himself in any way until the trance is broken.

Ectoplasm

Range: 40 feet+5 feet per level of experience(12.2+1.5 m).

Duration: 4 minutes (16 melees) per level of experience.

I.S.P.: Vapor — 6 I.S.P., Solid — 12 I.S.P.

This mystifying ability enables the psychic to create a slightly luminous, vapor-like substance that is extruded from the pores. Ectoplasm has two forms: an invisible vapor and a luminous, solid state.

The vapor is a sort of floating, probing finger that can snuff out candles, open doors, knock over or pick up small objects (weighing under 9 ounces/255 grams), tap somebody on the shoulder, rustle leaves and knock on a door. The ectoplasmic vapor can be seen only by its creator, psychics and supernatural beings who can *see the invisible*, or with *infrared optic systems* (including i.r. camera lenses, i.r. gun sights, etc.). Ectoplasm, although an invisible vapor, has *physical properties*, which means it can not go through walls or other solid obstructions. Thus, a person walking into an ectoplasm stream may feel a slight sensation, like walking into a spider’s web or brushing against a cotton ball. Often a person will unwittingly walk into and snag the stream of floating ectoplasm, pulling or stretching it along without being aware of it. In such cases, the psychic must maneuver the snagged portion to loop around the human obstruction. The creator of the vapor can control the full length of the vaporous stream like a floating tentacle. Although the vapor can not go through solid objects, it can slip through keyholes, cracks under doors or loose seals around a window. If a breeze can blow through, so can ectoplasm. The only drawback is that the character must be able to see the ectoplasm to maneuver it.

The solid state of ectoplasm can be a startling sight, for it is clearly visible to everyone. In this form the ectoplasm can be shaped into an extra limb, such as a hand or arm and hand, or tentacle or even a foot. The ectoplasmic limb appears as a white, slightly luminous appendage connected to a trail of ectoplasm stretching back to its creator like a lifeline of silly putty. The appendage and its connecting line can hover, float, levitate and fly (at a speed of 18). The solid ectoplasmic limb has much greater strength; able to carry, lift or hold up to 40 lbs/18 kg, but can not squeeze through the tiny openings that the vapor can. An opening must be at least the size of a quarter for solid ectoplasm to

fit, and then the limb must be turned into a thin tentacle and reformed on the other side of the opening. Ectoplasm can also be used to create a face or even a full figure, although detailed features are impossible. Ectoplasmically created images may explain apparitions reported during some seances.

Ecto-Combat: The ectoplasm vapor and solid form both have an *automatic dodge* against all attacks directed at any of its length. That means an attempt to hack the middle of the ectoplasmic stream/connecting line will see that portion of the ectoplasm suddenly swerve, loop or bend with a life of its own to avoid the attack. The dodge at the midsection (or anywhere else) does not count as an attack/action by the appendage at the other end. The appendage also gets an automatic dodge in addition to its attacks/actions per melee. A vapor or solid appendage *must* be controlled by its creator at all times (except the automatic dodge); thus, it has a number of attacks/actions equal to its creator's. So, if the psychic has four attacks per melee, the ectoplasm appendage also has four attacks. However, each attack/action by the ectoplasm counts as one of the character's attacks/actions that melee.

The solid ectoplasm appendage is not a great tool for combat. It limits the person's attacks/actions per melee and has minimal strength; equal to about a P.S. attribute of 4. A punch or kick does a mere one point of damage. Damage can be increased by the appendage using any type of hand-held weapon under 40 lbs and less than five feet (1.5 m) in length. Small modern weapons, such as a pistol or revolver, can be used, but are minus -10 to strike. The vapor can not use any weapons weighing more than 9 ounces and can inflict no damage of its own.

Ecto-Combat Statistics

- Vapor and solid get an automatic dodge against all attacks, including multiple or simultaneous attacks.
- +5 to dodge; applies to vapor and solid.
- +1 to parry; applies to vapor and solid.
- +1 to strike; applies to vapor and solid.
- Astral S.D.C. is 40 plus one hit point. Applies to vapor and solid. If the ectoplasm is destroyed the creator takes one hit point and 10 S.D.C. of physical damage.
- Vapor inflicts no physical damage, but can touch, tap or pick up and carry objects weighing 9 ounces or less.
- Solid ectoplasm inflicts one point of damage in combat or by weapon.
- Attacks or actions per melee are equal to its creator's. Each attack/action by the ectoplasm, excluding dodges, counts as one of the character's attacks that melee. A pair of ectoplasmic limbs will divide the attack between the two equally.
- Sunlight or bright artificial light (250 watts) reduces the range to half.
- Maximum range possible for vapor and solid is 40 feet plus 5 feet per level of experience (12.2+1.5 meters per level).
- One full melee (15 seconds) is required to create an ectoplasm vapor or solid appendage.
- Half a melee (7 seconds) is needed to withdraw/return ectoplasm into its creator.

Electrokinesis

Range: Varies

Duration: Varies

I.S.P.: Varies

Electrokinesis is a psychic power that allows the psychic to exert amazing physical control over electricity.

1. Electrical Resistance. The psychic can manipulate his body so to become resistant to electricity. Up to 60,000 volts will inflict no damage or ill effect. Currents greater than 60,000 volts, including lightning and magic electricity, do half damage. **Range:** Self. **Duration:** 3 minutes per level of experience. **I.S.P.:** 4.

2. Electrical Discharge: The character can cause *static* electricity within a six foot (1.8m) area, as well as emit an electrical discharge by touch. *The discharge* can be a little jolt or inflict up to 1D6 damage as often as once per melee. **Range:** touch or 2 foot distance. **Duration:** Instant. **I.S.P.:** 2 per each discharge.

3. Manipulate Electrical Devices: Through focused thought, the psychic can enforce a limited control over electrical devices, such as turn off and on light switches, computers, televisions, radios, blenders, microwave ovens, flashlights, toys (battery and plug types), windshield wipers, and all types of electrically operated appliances, toys and devices. He can also manipulate the controls of the device, such as volume, channel selection, tuners, speakers, change speed, dim lights, and so on. A dozen different electrical functions can be manipulated each melee. This can mean flicking the light off and on six times (12 functions/6 off, 6 on) or turn on the T.V., turn its volume up to the max. and turn on 10 other appliances (12 functions in all). **Range:** 45 feet+5 feet per level of experience (13.7+1.5 m per level). **Duration:** 2 minutes per level of experience. **I.S.P.:** 4. **Note:** The character does not need to see the devices to manipulate them. He can feel their presence.

4. Sense Electricity: The psychic can sense or feel electricity and pinpoint its exact location with fair expertise. **Range:** 45 feet+5 feet per level of experience. **Duration:** 2 minutes of extreme sensitivity when he can pinpoint every source of electricity in the area. **I.S.P.:** 2 per every two minutes. **Base Skill:** 55%+5% per each additional level of experience. *A failed roll* means only 1D6×10% of all the electrical devices/sources of electricity could be sensed.

Hydrokinesis

Range: Varies

Duration: Varies

I.S.P.: Varies

This ability enables the character to use psychic energy to sense and influence water.

1. Sense Chemical Impurities: The psychic can sense whether or not water is polluted/contains other substances. The exact nature of the additive or pollutant may be unknown, but he will know that it is not completely natural. *When sensing water, first roll to determine:* **1) Pure or Drinkable** (non-hazardous/tap water) 70%+5% per each additional level of experience. **2) Second**, roll for **general nature of the pollutant**; this identifies whether it is chemical/drug (not deadly, but will cause a reaction if drunk) or poison/toxin (deadly or harmful if swallowed). Success ratio in identifying the general nature of the pollutant is

35%+5% per each additional level of experience. **Range:** self/six inches. **Duration:** One minute (4 melees). **I.S.P.:** 2 per minute.

2. Boil Water: The psychic can increase the temperature of water, raising it to boiling level within one minute (four melees). Up to one gallon (3.8 liters) can be affected. Once set a boiling, it will take the usual amount of time to cool. This power can *not* be made to boil the water or blood in a living creature. **Range:** 8 feet (2.4 m)+2 feet (.6 m) per level of experience. **Duration:** One minute (4 melees). **I.S.P.:** 3 per gallon of water.

3. Water Spout: An ability that enables the psychic to control and hurl water. The effect can be used to make water bubble (but not heated), shoot straight up like a geyser or a water blast hurling across a room like a short, powerful spray from a garden hose. Up to one gallon of water can be manipulated and hurled up to a distance of 20 feet. **Note:** The fluid must be 75% water to be controlled, such as punch, hot coffee, chicken soup, tea, kool-aid, etc. Forget about hurling ice (frozen does not count), paint, gasoline or cake batter.

Making water leap with a life of its own can be startling to others and can make a great distraction if handled right. Hurling normal water or a cool drink into somebody's face/eyes will momentarily blind and surprise the individual, causing him/her to lose initiative and one attack that melee. Hurling hot or boiling water on the body (especially the crotch) will have the same results. Hurling *boiling water* in the face is horribly painful, causing 2D4 damage, loss of initiative, loss of all attacks for 1D6 melees and temporary blindness for 3D6 melees (-10 to strike, parry and dodge). Characters of a good alignment will not hurl boiling water in the face unless under an absolutely life and death circumstance.

Hurling range: 20 feet/6.1 m. **Duration:** Instant. **I.S.P.:** 5. **Bonus:** +1 to strike. Making water bubble or rise up like a fountain can be maintained for up to 30 seconds (2 melees). **Note:** The psychic can influence up to one gallon of water up to 20 feet away, whether he can see it or only feel its presence.

4. Sense Water: The character can sense the presence of any water exposed to the open air automatically, at no cost of I.S.P. **Range:** 20 feet/6.1m. **Duration:** Permanent. **I.S.P.:** None. **Note:** Underground rivers, airtight containers, etc., can *not* be sensed.

Impervious to Cold

Range: Self

Duration: 20 minutes per level of experience.

I.S.P.: 2

A mind over matter discipline which enables the character to suffer absolutely no ill effects or discomfort from exposure to even extreme freezing conditions.

Impervious to Fire/Heat

Range: Self

Duration: 3 minutes per level of experience.

I.S.P.: 4

Another mind over matter discipline enabling the psychic to endure intense heat, fire, boiling water, hot coals, and so on without suffering pain, damage or scarring. Magic fires inflict *half* damage.

Impervious to Poison/Toxin

Range: Self

Duration: 2 minutes (8 melees)

I.S.P.: 4

The character can negate the full effects of poisons and toxic chemicals which he has ingested (eaten or drank) or introduced into the bloodstream, as long as he/she has advance knowledge of its deadly properties. A poison, toxin, or drug which has been unknowingly inflicted (and starting to take effect) can be negated too, but will do *half damage* or effect before it can be completely negated. **Bonuses:** Identify poisons — 30%+4% per level of experience; +2 to save vs poisons and drugs.

Levitation

Range: Up to 60 feet/18.3 m away.

Duration: 2 minutes per level of experience.

I.S.P.: Small — 2, medium — 6, large — 6 per every 10 pounds of weight.

Saving Throw: None

Levitation is a limited form of telekinesis that can raise an object (or even a person) straight up into the air and suspend it there (hover). Small objects weighing two pounds (0.9 kg) or less are the easiest to levitate. Maximum height is 8 feet (2.4 m) plus one foot (0.3 m) per each level of experience. Medium size objects weighing 3 to 20 pounds (1.4 to 9.1 kg) are more difficult, requiring greater concentration. Maximum height is 6 feet (1.8 m) plus one foot (0.3 m) per level of experience. Large objects or people weighing over 20 lbs cost 6 I.S.P. plus 1 I.S.P. for every 10 lbs beyond 20. Thus, a 125lb weight (56.7 kg) would require 17 I.S.P. to raise it into the air. Maximum height is 4 feet (1.2 m) plus one foot (0.3 m) per level of experience.

Meditation

Range: Self

Duration: Varies with the person's needs.

I.S.P.: None

Meditation is the only ability that can be done at any time and costs no I.S.P. to perform. Meditation is not so much a psychic power as it is a mental discipline. The character meditates by dwelling upon a single notion, mental object, or mantra (a repetitious chant or humming), to achieve a deep relaxation, focus, or to gain insight and harmony into one's inner self, nature and the universe. Meditation is often required to use psychic and magic powers.

Mind Block

Range: Self

Duration: 10 minutes per level of experience.

I.S.P.: 4 (per each duration period)

This is the ability to completely close or block oneself from all psychic/mental emanations. When intentionally closed to supernatural or psychic forces, the character can *not* sense anything, can not use psychic abilities, nor be influenced by others. A mind block will prevent penetration of telepathy, empathy, hypnotic suggestion, and empathic transfer. It can be an invaluable protective mask when dealing with malevolent psychic forces. Adds a bonus of +1 to save vs all psychic and mental attacks.



Pyrokinesis

Range: Varies

Duration: Varies

I.S.P.: Varies

Pyrokinesis is a psychic power that gives a character the power to manipulate fire.

1. Fire Resistant: The psychic can endure great heat and fire with minimal ill effect. **Damage** is reduced by half. Magic fires do full damage. **Range:** Self. **Duration:** 5 minutes per level of experience. **I.S.P.:** 2.

2. Spontaneous Combustion: The ability to create a spark that will ignite combustible material, such as paper, old rags, dry grass, gasoline, etc. Note: Human hair should not be considered a combustible material. This is a slow fire, starting with a tiny spark and grows. Initially, it is not a roaring blaze. **Range:** Can be ignited up to 30 feet away (9.1 m). **Duration:** Instant; fire will last and spread until it is put out or there is nothing to burn. **I.S.P.:** 2.

3. Fuel Flame: The character can feed the fire with psychic energy, doubling it in size. **Affects** a 10 feet (3 m) area. **Range:** Up to 30 feet+5 feet for each additional level of experience. **Duration:** Instant. **I.S.P.:** 4.

4. Extinguish Flames: The power to instantly put out an area of fire. **Affects** a 15ft (1.5 m) area of fire. **Range:** Up to 30 feet+5 feet per each additional level of experience. **Duration:** Permanent until set on fire again. **I.S.P.:** 4.

5. Create Flame: The incredible ability to create fire out of thin air. Can be an 8 feet pillar of fire affecting a 4ft (1.2 m) area or a 6 foot wall of fire stretching six feet long (1.8 m) plus one foot per each additional level of experience. **Damage:** 4D6 from the pillar, 6D6 from the wall, plus both have a 72% likelihood of setting any combustibles they touch ablaze (including cloth, rugs, curtains, furniture, etc.). **Range:** Cast up to 30 feet+2 feet per additional level of experience. **Duration:** 2 minutes per level of experience; longer if it sets other things on fire. **I.S.P.:** 20.

Another fire creation ability is the hurling of a *fire ball*. **Damage:** 6D6, **Range:** 30 feet+2 feet per each additional level of experience. **Duration:** Instant. **Bonus:** +2 to strike. **I.S.P.:** 25.

6. Sense Fire: The psychic can sense or feel the presence of fire and pinpoint its exact location. **Range:** 100 feet+5 feet per level of experience. **Duration:** 2 minutes of extreme sensitivity when he/she can pinpoint the exact location of every fire in the area. **Base Skill:** 90% success ratio. A failed roll means only 2D4×10% of the fires can be located by sensing. **I.S.P.:** 2 per every 2 minutes.

Resist Fatigue

Range: Self

Duration: 1 hour+20 minutes per level of experience.

I.S.P.: 4

A mind over matter discipline which enables the character to engage in physical activity without suffering from exhaustion. Although fatigue is temporarily suspended, the psychic will feel extremely tired and may even collapse when the psi-power's time limit lapses.

Resist Hunger

Range: Self

Duration: 6 hours

I.S.P.: 2

Another mind over matter discipline that subdues any feeling of hunger, allowing the character to function at full effectiveness without nourishment. It is important to point out that while the psi-power maintains full operations, the body is still suffering from malnutrition and starvation. Loses 3 lbs of weight per day.

Note: A psychic can survive up to 60 days, functioning as normal, without any food by continually using resist hunger. On day 61 the character will lapse into a coma. Under this extreme condition, 60 days of food deprivation while still fully active physically, the character is -20% to save vs coma/death.

Resist Thirst

Range: Self

Duration: 6 hours

I.S.P.: 6

This ability is identical to the resist hunger psi-power except it applies to the consumption of water. It does not negate the long-range damage from dehydration.

Speed Reading

Range: Self

Duration: 3 minutes per level of experience.

I.S.P.: 2

This is the ability to read and comprehend the written word extremely quickly. Speed of reading is 30 pages per minute/4 melees. The psychic will retain the information as he would normally. Highly technical texts will reduce the speed reading by half (15 pages per minute) and may require two readings.

Summon Inner Strength

Range: Self

Duration: 10 minutes per level of experience.

I.S.P.: 4

This psi-power enables the character to draw on his inner reserves of strength to ward off pain and fatigue. Every time the psychic calls upon his inner strength, the following bonuses apply:

- Add +10 S.D.C.
- Add +2 to save vs poison or toxins.
- Add +5% to save vs coma/death.
- Fatigue is temporarily forgotten and the character can function as if he was fully rested for the full duration of the summon inner strength power.

Telekinesis

Range: Up to 60 feet (18.3 m) away.

Duration: 2 minutes per level of experience.

I.S.P.: Small — 3, medium — 8, large (over 20 lbs) — 8+1 per every 10 lbs of weight.

Telekinesis is the ability to move objects without any other means than directed psychic energy. The character can make an object hop, fall, roll, rise into the air, suspend it there (hover) or make it fly across the room.

In order to move an object by telekinesis, the item must be clearly visible, within the psychic's range (60 feet/18.3 m) and the point of focus. As usual, the psychic must concentrate on what he is doing; thus, each telekinetic feat counts as one of the character's physical attacks. The total number of telekinetic attacks is equal to the character's number of physical attacks per melee; usually 3 or 4. One can attack with telekinesis by hurling an object as if thrown or causing it to buzz about a room, swinging and hitting like a club controlled by an invisible hand. Several objects can be telekinetically thrown around within the same melee round, but not simultaneously. The psychic can only concentrate on one item at a time. **For Example:** A physical psychic with four, normal, hand to hand attacks per melee can perform four attacks with telekinesis. First, he makes a flower vase fly from the table, aiming it at his opponent's head. Second, he makes the lamp hurl at the guard at the door. Third, the table is suddenly flipped up on end and, fourth, the doorknob is turned and the door flung open. Four attacks or actions using telekinesis.

As we can see in the example, telekinesis can be used to do more than make objects fly around. The telekinetic power can be used to open doors, flick switches, press buttons, turn knobs and dials, open windows, make a rocking chair rock and so on. The range of possibilities is extensive when you stop and think about it. Remember, each action counts as one of the character's physical actions/attacks per melee.

It is easiest to move or hurl small objects weighing two pounds (0.9 kg or less). Maximum height or distance is 60 feet (18.3 m). Medium size objects weighing 3 to 20 pounds (1.4 to 9.1 kg) are more difficult to manipulate. Maximum height or distance is reduced by half — 30 feet (9.1 m). Large or heavy objects weighing over 20 lbs are the most difficult to maneuver, reducing maximum height and distance to 15 feet (4.6 m). I.S.P. cost for large, heavy objects is 8 I.S.P. for the first 20lbs (9.1 kg) plus one I.S.P. for each additional 10lbs (4.5kg) of weight. This means it would cost 19 I.S.P. to move a 125lb (56.7kg) weight (8 I.S.P. for the first 20lbs+11 I.S.P. for the remaining 105lbs). Remember, the height and distance of effect is limited to 15 feet (4.6m) for such a heavy item.

Combat Bonuses:

- +3 to strike with telekinesis; physical/skill bonuses to strike do not apply when telekinesis is used.
- +4 to parry with telekinesis by using a controlled object to parry or sheer telekinetic force to block an attack. Counts as a medium, heavy object; costs 8 I.S.P.
- Damage from Hurlled Objects:
 - Small: 6 ounces to 1 pound — 1D4
 - Small: 1 to 2 lbs — 1D6
 - Medium: 3 to 4 lbs — 2D4
 - Medium: 5 to 10 lbs — 3D4
 - Medium: 10 to 24lbs — 3D6
 - Large: 26 to 40 lbs — 4D6

Add 1D6 for each additional 20 lbs of weight.

Note: Telekinesis is not a force field, thus, while it can be used to parry/block a punch, kick, club, knife or even sword, it can not stop bullets, arrows, gas, flying tackles, and similar attacks. Furthermore, a failed roll to telekinetically parry means the psychic did *not* parry and *is* struck by his opponent.

Total Recall

Range: Self

Duration: Permanent

I.S.P.: 2

The character remembers every word he reads. Specific blocks of information can be recalled in perfect detail at will. Each block of information costs 3 I.S.P. to recall in absolute detail. If all I.S.P. have been expended, the memory is a little fuzzy so that exact quotes and details may be impossible to recall. *Roll percentile:* 1-50 remembered in full detail, word for word; 51-80 details are forgotten, but the full essence of the ideas are clear; 81-00 can only recall the most basic concepts no details nor strong comprehension.

PSYCHIC HEALER ABILITIES

Deaden Pain

Range: Immediate proximity, touch or within 3 feet (0.9 m).

Duration: One hour per level of experience.

Length of Trance: Two minutes (8 melee rounds).

I.S.P.: 4

The ability to deaden pain can be used as a painkiller which temporarily negates existing pain or as an anesthetic to be used for surgery.

Exorcism

Range: Immediate area, touch or within 8 feet (2.4 m).

Duration: Instant, if successful.

Length of Trance: 30 minutes of preparation and 6D6 minutes with the possessed person or animal. Note: can only exorcise the living.

I.S.P.: 10

The healer can perform a rite of exorcism that uses psychic energy to expel the loathsome being from its mortal, host body. A completely successful exorcism will free the victim of the supernatural force that controls him and send it back to its own non-earthly world. A partially successful exorcism will drive the evil force out of the possessed person or animal, but does *not* send the damnable thing back to its own dimension. Thus, it can try to possess the healer or flee to wander the Earth in search of new victims. An exorcism can only be used on living persons or animals whose bodies are inhabited by a supernatural entity or creature. *Also see possession.*

Roll to determine success for an exorcism at the end of the time period. **First**, roll to see if the being has been expelled from its victim's body. **Success ratio:** 28%+7% per each additional level of experience. **Second**, roll to see if the thing is forced back into its own dimension. **Success Ratio:** 21%+7% per each additional level of experience. A failed roll means the creature can remain in our dimension, but it must leave the area and can not possess the same individual for at least six months. **Note:** The chance of a successful exorcism on a *nega-psychic* is reduced by half, as is the success ratio for sending the being back to its own dimension. The same is true of some of the more powerful supernatural beings.

During the exorcism, the possessing force can use whatever powers it may have, as well as physical attacks or any special psychic abilities of its host body. Fortunately, the rite of exorcism weakens the creature, reducing its number of attacks per melee by half. It is wise to always have one or more assistants to help defend against the being's attacks and actions. Sedating the physical host body will immobilize it, but will not prevent psychic attacks or the creature's use of its natural powers. Too many assistants or spectators can be a liability, for the creature may attempt to flee by possessing one of them. An exorcism can be attempted on the same individual as often as the healer desires.

Healing Touch

Range: Touch.

Duration: Instant, with lasting effects.

Length of Trance: Two minutes (8 melee rounds).

I.S.P.: 6

The healing touch is a remarkable healing ability that can instantly heal cuts, burns, bruises and similar physical wounds. The touch restores 1D8 hit points *or* 2D6 S.D.C. The healing touch can only be used on other living creatures, never on himself.

Impervious to Cold

Range: Self

Duration: 20 minutes per level of experience.

Length of Trance: 1D4 melees for preparatory meditation.

I.S.P.: 2

A mind over matter discipline which enables the character to suffer absolutely no ill effects or discomfort from exposure to even extreme freezing conditions.

Impervious to Fire

Range: Self

Duration: 3 minutes per level of experience.

Length of Trance: 2D4 melees for preparatory meditation.

I.S.P.: 4

Another mind over matter discipline enabling the psychic to endure intense heat, fire, boiling water, hot coals, and so on, without suffering pain, damage or scarring. Magic fires inflict *half* damage.

Increased Healing

Range: Touch or within 3 feet (0.9 m).

Duration: 2D4 days.

Length of Trance: 1D6 hours.

I.S.P.: 10

The healer is able to stimulate *another* person's healing energies, dramatically increasing one's recuperative powers. Hit points and S.D.C. recovery are double the normal professional treatment rate.

Induce Pain

Range: Touch or within 6 feet (1.8 m).

Duration: As long as the trance is maintained.

Length of Trance: One melee/15 seconds is needed to prepare, before pain can be inflicted. The length of the pain inducing trance is completely up to the psychic.

I.S.P.: 2 per minute.

Saving Throw: Standard

The ability to inflict a terrible, debilitating pain without physically damaging the living creature. Victims are -6 to strike, parry and dodge, lose initiative, skills are -30%, and attacks per melee are half. There is a good chance of the victim passing out after five minutes of continuous pain; 50%+10% per each additional minute.

Induce Sleep

Range: Touch or within 6 feet (1.8 m).

Duration: One hour per level of experience (or until awakened).

Length of Trance: Two minute preparatory meditation.

I.S.P.: 4

Saving Throw: Standard; plus unwilling victims are +5 to save vs psychic attack.

This is not an offensive ability, but is intended to be a recuperative power to induce sleep on those who are ill, exhausted, or an insomniac. The person will fall into a normal, restful sleep from which he can be easily roused. Unwilling victims of the induce sleep psi-power get a +5 bonus to save (because this is not the intent of the ability) and can not be involved in combat at the time.

Psychic Diagnosis

Range: Touch or within 3 feet (0.9 m).

Duration: Immediate knowledge.

Length of Trance: 2D4 melees of meditation.

I.S.P.: 4

Saving Throw: None; except for the nega-psychic, standard.

The psychic healer can sense physical pain, damage, disease and possession with absolute clarity. This pinpoint accuracy enables the character to suggest treatment or to conduct psychic surgery.

Psychic Purification

Range: Touch

Duration: Immediate

Length of Trance: 6D6 minutes of meditation.

I.S.P.: 8

Saving Throw: None; except for the nega-psychic, standard.

The healer can use his abilities to slow a person's metabolism and destroy chemicals, drugs, poisons, and toxins in the body.

The effects of the drugs/impurities are immediately halted at the beginning of the meditation, and completely destroyed/negated by its end. Damage sustained prior to the psychic's intervention still exists.

Psychic Surgery

Range: Touch

Duration: Varies with injury.

Length of Trance: 2D6 minutes of preparatory meditation, plus the duration of the surgery (which is half the time of conventional modern medicine).

I.S.P.: 14

Psychic surgery is used to repair broken bones, internal injuries, the removal of foreign objects (bullets, etc.), or when a character has suffered so much damage that he or she has lapsed into a coma (zero or less hit points). *The recovery from a coma* (near death) is equal to treatment from a hospital, 1-66%, when psychic surgery is used. Note that there is absolutely no scarring from psychic surgery and minimal pain (no pain if the deaden pain psi-ability is used). No tools are needed, only the psychic's hands. **Note:** A psychic diagnosis *must* be made before surgery is possible.

Resist Fatigue

Range: Self

Duration: One hour plus 20 minutes per level of experience.

Length of Trance: 1D6 melees of preparatory meditation.

I.S.P.: 4

A mind over matter discipline which enables the character to engage in physical activity without suffering from exhaustion. Although fatigue is temporarily suspended, the psychic will feel extremely tired and may even collapse when the psi-power's time limit lapses.

Suggestion (Hypnosis)

Range: 10 feet (3.0 m), with eye contact.

Duration: Varies; rarely more than an hour or two.

Length of Trance: One melee (15 seconds) of preparatory meditation.

I.S.P.: 4 per idea, or attempt to implant an idea.

Saving Throw: Standard.

This ability is identical to the psychic sensitive.

The Nightbane

The Nightbane are the central characters of the Dark Day invasion. They are creatures both mundane and nightmarish, normal people gifted and cursed with great power and thrust into extraordinary circumstances. On the day of their Becoming, they learned that their human bodies hid something far more powerful and terrifying than they could ever imagine. This discovery is followed by the fact that, like it or not, they have been thrown into a war with supernatural forces. A war that will only end with victory or death.

The Two Sides of the Nightbane: The two forms “worn” by Nightbane are symbolic of the duality that affects the entire race. Nightbane have a human form, contemptuously called the **Facade**. It is the shape they grew up with and which they considered their only shape before the Becoming. After their supernatural nature manifests itself, the Nightbane can switch back and forth between the Facade and an alien, monstrous form known as the **Morphus**. Nobody is sure which one is the “real” or “true” form, although most Nightbane tend to consider the Morphus to be their “true” shape. Each Nightbane is forced to deal with that question of identity. Are they humans gifted with a shadowy, alien shape and superhuman powers, or are they alien beings masquerading as humans? Or are they something else? Many of the Nightbane who have decided the second choice is true have turned their backs on humankind. Those who chose the first theory try to help their fellow humans by using their powers to heal and protect. Many more never find a satisfactory answer.

The Race of the Thousand Shapes: Unlike any known species, the Nightbane do not have a standard physical appearance. Each Nightbane has a unique Morphus, each of which has its own advantages and disadvantages. To determine the shape and abilities of a Morphus, refer to the **Creating the Nightbane Section** in this book. The form can be created randomly, half-randomly, or by player’s choice, depending on the style of the gaming group and the G.M. It is believed that the Morphus reflects the Nightbane’s personality, or is an aspect of his/her personality. Others think it might be the embodiment of the Nightbane’s soul, in all its beauty and ugliness. This means the Morphus’ appearance and powers can be used as a powerful role-playing tool to create angst, fear, suspicion, awe or wonderment.

Creating the Character

When creating a Nightbane character, the player should keep in mind that most Nightbane were normal young adults or teenagers until their Becoming. Even after their transformation, they do not automatically change into alien predators or savage monsters — although their appearance might suggest so. The contrast between the Nightbane’s alien appearance and their basically human personality and outlook is one of the main “themes” of this game.

It would be a good idea to ask oneself a number of questions about the character even before rolling dice and assigning attributes. Some of these answers should be written down and given to the Game Master, so he/she’ll have an idea of where the character is coming from. Where did the character grow up? Was he adopted by loving parents, or did he spend his years in orphanages, foster homes or even in the streets? What kind of education did he receive? All these factors will help decide which skills will be appropriate to the character.

Other questions can help define the character’s recent history. Where was he/she during **Dark Day**? What was the first Becoming like? Although Nightbane are extremely resilient to mental shocks, some players may decide their characters suffered some personality disorders as the result of their transformation. When and how did the character meet with others of his kind? Did he endure hatred and fear from former friends or loved ones? If not, does he still keep in touch with them?

Finally, the association with one (or none) of the Nightbane Factions will help round up the character. If the campaign is set 2-4 years after Dark Day, the Factions will be fairly well-defined and separate; during the beginning of the invasion, only two or three existed. How did the character come to join a Faction? What role does he play in it? Does he fully agree with the goals of his/her Faction, or is he just going along to survive? What are the character’s personal goals? Is he fighting the Nightlords (if he is) because he has no choice, or does he have nobler motives (and if so, what are they)?

Answering these questions will help define the character, and should provide the Game Master with ideas for sub-plots and adventure “hooks.”

The Natural Powers of the Nightbane

The following are abilities common to ALL Nightbane. None are available for use until after the first manifestation of the Becoming. Some of these supernatural abilities are only available to the character when in Morphus form. In other cases, the power may be increased in Morphus form but is also available, in a weaker state, while in human shape.

1. The Becoming: Nightbane appear to be normal humans until they experience their Becoming transformation. From that day forward they have two identities, human and superhuman monster. After the first Becoming, the Nightbane have the ability to shift at will from their human Facade to their Nightbane shape, the Morphus.

The Becoming takes one full melee round (15 seconds), unless the Nightbane makes a Mental Endurance save (12 or



higher; use M.E. bonuses, and is +1 at first level, and an additional +1 for every two levels after the first). A successful M.E. save means the Becoming will take less than one melee attack/action (about 3 seconds). The transformation process varies widely from one Nightbane to another. In some cases (especially when the Morphus is a lot larger than the Facade), clothes disappear, coming back only when the Nightbane returns to his Facade. In other cases, the Nightbane appears wearing the same clothing he had in his Facade, or is wearing a different set altogether. Players should decide which effect occurs with their character, subject to approval by the Game Master.

2. Supernatural Senses: The Nightbane have nightvision in both the Morphus and the Facade, but the range changes dramatically; 200 feet (61.0 m) in the Facade, or 500 feet (152 m) in Morphus form. Some Nightbane have Morphus with even more powerful nightvision, and can see in total darkness for 1000 feet (305 m). Nightbane in either form can sense the presence of other Nightbane (but not other supernatural creatures). The range of this sense is determined by the relative power of each specific character. The base range is 300 feet (91.4 m) plus 30 feet (9.1 m) per level. If the character can see his fellow Nightbane and he is in range, he will automatically know whether or not that person is a member of his race, regardless of the person's current form. If the Nightbane cannot see the person, he may still be able to sense the near presence, general direction and distance of a Nightbane by making a *perception roll*; this is a conscious effort.

3. Supernatural Attributes: Nightbane have supernatural strength and endurance. In addition to their great amount of S.D.C. and hit points, they can regenerate damage at the rate of 10 S.D.C./hit points at the end of each melee round! Massive damage (being hit by automatic weapons, for example) will overwhelm this regenerative power causing a coma or death. Nightbane are not invulnerable and they can be hurt or killed by any weapon!

4. Mirror Walk: While wearing their Morphus form, the Nightbane can use mirrors to cross over into and out of the Nightlands. To perform this ability, a mirror of any size, even a small hand mirror, will do, but the mirror must have a counterpart in the Nightlands. Typically, mirrors built into homes and buildings will have a counterpart in the alien dimension. Mirrors on vehicles rarely do because there are no cars in the Nightlands. Once the mirror walk is begun, the Nightbane's body will flow like thick liquid to pour through a mirror of any size. Seeing a Nightbane pour himself into a small mirror has a Horror Factor of 12 for those not familiar with the process. The Mirror Walk costs 2 P.P.E. points and takes one melee round (15 seconds) to perform. A Nightbane can carry additional cargo or equipment (not counting clothes) of up to 100 lbs (45 kg). The character can also transport other people through the mirror but at the incredible P.P.E. cost of one point per every two pounds (0.9 kg) transported in this matter. For example, carrying a 160 lb. (72.5 kg) person across the Mirrorwall will cost the Nightbane 80 P.P.E.!

5. Immunities: Nightbane are immune to all forms of *mind control*, including vampiric control, spells, and psionic powers. They are also immune to the vampire's slow kill bite (see the **Vampire Threat Section**). All other forms of attack inflict normal damage and magic or psionics can be very effective against them.

6. Morphus Powers and Bonuses: The actual appearance of the Morphus will grant the Nightbane a number of attribute bonuses and other abilities. Among them is the ability to fly, a higher Horror Factor, and bonuses to attributes and S.D.C. See the **Creating the Nightbane Section** for more information.

7. Talents: Nightbane instinctively master a number of powerful abilities collectively known as *Talents*. Nightbane gain more Talents as they advance in level, or can acquire them by "burning off" P.P.E. At first level, Nightbane gain one Talent at no cost; they can select more Talents by *permanently* spending P.P.E. Select one more "free" Talent at levels four, seven, ten and twelve.

8. Immune to Transformations: The Nightbane cannot be physically transformed by any means, including but not limited to the following: metamorphosis potions and spells, the transformation ritual, vampire transformation, petrification, turn to mist, curses, wishes, or any form of magic or supernatural transformation, spell or enchantment.

The Nightbane R.C.C.

The following are the basic stats applicable to ALL Nightbane. Specific training and orientation are presented for variations within the R.C.C. and may add a few different nuances to each character.

Attributes (Facade): Roll attributes normally (3D6). These are the attributes of the Facade, the human shape. The Facade's attributes are NOT supernatural. Hand to hand damage is normal, modified by standard P.S. bonuses. Most Nightbane talents cannot be used in the Facade; spells, if known, can be cast in either form.

Attributes (Morphus): The Morphus, or "true" form of the Nightbane, has higher than normal physical attributes. Add +10 to P.S., P.E. and Spd, and +6 to P.P. Also, some Nightbane characteristics may raise or lower attributes (see the **Creating the Nightbane Section**).

S.D.C. (Facade): The base S.D.C. is higher than human: 30 plus skill bonuses.

S.D.C. (Morphus): Add 2D6×10 S.D.C. to the Facade's S.D.C. total. Also, some Nightbane characteristics will raise this S.D.C. score (see **Creating the Nightbane Section**, below).

Hit Points (Facade): Standard (P.E. plus 1D6 per level of experience).

Hit Points (Morphus): P.E. x2 plus 2D6 per level of experience.

Horror Factor: Nightbane have a base Horror Factor of 6 regardless of the Morphus appearance (none in human form). The shape of their Morphus will increase this Horror Factor to a maximum value of 18 (see **Creating the Nightbane Section**).

P.P.E.: P.E. attribute (use the Facade's P.E.) plus 3D6×10+20. Add 3D6 P.P.E. per level of experience.

Average Life Span: Unknown. Many Nightbane are known to have lived over a thousand years, with some rumored to be over 5,000 years old!

Combat: While in the human, Facade shape, the character is limited to human fighting skills.



All Nightbane in Morpheus form have innate combat abilities equivalent to *hand to hand: martial arts!* These superior combat skills manifest themselves the moment the transfor-

mation is complete. In addition, while in Morpheus form, add one hand to hand melee action/attack and all appropriate bonuses. Players should keep track of combat bonuses separately for *each* form.

Damage: In Facade, by weapon or normal hand to hand damage only. In Morpheus, use the Supernatural Strength table. Some Morpheus also provide natural attack weapons such as claws, sharp teeth, etc.

Bonuses: Facade: +2 to save vs magic, +1 to save vs disease, +1 to save vs horror factor; all are in addition to attribute and skill bonuses.

Bonuses: Morpheus: +1 on initiative, +2 to strike, parry and dodge, +3 to roll/pull punch, +4 save vs magic, +3 to save vs psionics, +3 to save vs disease, and to +3 to save vs horror factor; all in addition to attribute and skill bonuses.

Magic Powers: None

Psionic Powers: None. Nightbane lack the capability to use psionic powers. Some Talents protect against telepathic intrusions, however.

Vulnerabilities/Penalties: None. Can be harmed by any and all normal weapons, magic and most other forms of attack.

R.C.C. Skills: Several choices are available and described. The *Basic* skill package is meant for Nightbane who start play as normal young adults in 21st Century America. The assumption is that those Nightbane have not had much training beyond high school or a few college courses.

The other skill packages are for Nightbane who have joined one of the Factions and reflects areas of special training.

In all cases, these skill packages are meant as guidelines; Game Masters *may* allow players to select skills outside the groupings if they can come up with a convincing reason why they should have them. Of course, the final decision is left to the G.M., who is under no obligation to allow special skills or training; it is his or her choice. **Player's Note:** Characters should be more than a list of stats and skills. When selecting skills, players should consider how the character came to learn them. Sometimes determining skills can help develop some interesting elements of the character's background, elements that can be used in campaigns and adventures by the Game Master.

Secondary Skills: In addition to any of the skill groups described in the R.C.C. packages that follow, Nightbane characters get to select six secondary skills from the list presented below. Select an additional two at levels four and eight. These are additional areas of knowledge that do not get the advantage of the bonus listed in parentheses. All secondary skills start at the base skill level. Also, skills are limited (any, only, none) as previously indicated in the list.

Alliances and Allies: Depending on their affiliation, Nightbane may be working with humans, Guardians, Vampires, Wampyrs, and other beings. However, most of the character's allies, friends and partners will be other Nightbane.

Weapons and Equipment: Varies with the affiliation and background of the Nightbane. A typical character is likely to own a car (even if it's a clunker), motorcycle or other civilian vehicle, as well as a set of clothing and personal effects. Some may own much more, including dress clothes, a home computer or lap-top/hand-held computer, boom box/radio, CD player or tape player, a camera, books, jewelry and other odds and ends.

A member of the Resistance, a gang, or other militant group is likely to own or have access to handguns, rifles and even military small arms. Radios, surveillance equipment, survival gear, computerized databases and such are also available on a case by case basis. For the most part, however, Nightbane depend on their abilities rather than hardware.

Money: The typical Nightbane starts with 3D6×100 worth of cash. If he belongs to a Faction, more funds might be made available for emergencies or special missions. Otherwise, they earn money in their Facade form or from whatever they can scrounge, salvage or steal (usually from the enemy). Some may operate as soldiers of fortune, thugs for hire, or specialists and consultants using their education, skills and/or special Nightbane abilities for fun and profit.

Basic Nightbane Skill Package

This is a “normal” high school student or college freshman with little in the way of “adventuring” skills at the time of his Becoming. This skill package applies to most *teenage* Nightbane and those created in a “Dark Day Campaign” (see the **Campaign Section** for more information). At the Game Master’s discretion, characters who later join one of the Factions could be allowed to pick some new skills from those packages as they progress in level.

R.C.C. Skills:

- Basic Math (+10%)
- Native Language and Literacy (+20%)
- Computer Operation (+10%)
- One Domestic Skill of choice (+15%)
- One Electrical, Mechanical, Science or Technical skill of choice, limited by prerequisites (+10%)

Hand to hand combat must be selected as an “other” skill. Hand to hand: basic costs one skill selection, expert counts as two, and martial arts or assassin count as three skill selections. Remember, this hand to hand ability applies only to the Facade. Most Nightbane fight with combat abilities equal to basic martial arts combat when in their Morphus shape; an innate, instinctual ability.

R.C.C. Related Skills: Select 10 other skills. Plus select two additional skills at level two, two at level five, one at level eight and one at level twelve. All new skills start at level one proficiency.

- Communications: Radio: Basic only.
- Domestic: Any (+10%)
- Electrical: Any
- Espionage: Wilderness Survival only.
- Mechanical: Any (+5%)
- Medical: First Aid and Paramedic only.
- Military: None
- Physical: Any
- Pilot: Any
- Pilot Related: Navigation and Read Sensory Equipment only.
- Rogue: Any
- Science: Any
- Technical: Any
- W.P.: Any “civilian” W.P. (does not include military weapons such as assault rifles or heavy weapons).
- Wilderness: Any.



Resistance/Spook Squad-Trained Nightbane Skill Package

This is a Nightbane who has joined one of the militaristic/guerrilla Factions. Alternatively, this skill package indicates a character who was serving in the military at the time of his Becoming. Basic military skills and some hand to hand abilities (for the Facade; the Morphus has natural combat abilities) are included in the package.

R.C.C. Skills

- Basic Math (+10%)
- Radio: Basic (+15%)
- Native Language and Literacy (+25%)
- Computer Operation (+15%)
- Pilot (Vehicle of choice) (+15%)
- First Aid (+10%)
- One W.P. of choice
- Hand to Hand: Basic

Hand to hand: basic can be changed to expert at the cost of one “other” skill, or to martial arts or assassin at the cost of two “other” skills. This hand to hand applies only to the Nightbane’s Facade.

Related Skills: Select 8 other skills. Plus select two additional skills at levels three and six, and one at levels nine, and twelve.

- Communications: Any (+10%)
- Domestic: Any
- Electrical: Any
- Espionage: Any (+5%)
- Mechanical: Any (+5%)

Medical: Any
 Military: Any (+5%)
 Physical: Any
 Pilot: Any (+5%)
 Pilot Related: Any (+5%)
 Rogue: Any
 Science: Any
 Technical: Any
 W.P.: Any
 Wilderness: Any (+5%)



Related Skills: Select eight other skills. Plus select two additional skills at levels three and six, and one at levels nine, and twelve. All new skills start at level one proficiency.
 Communications: Radio: basic: , cryptography and TV/video only (+5%).
 Domestic: Any
 Electrical: Any (+5%)
 Espionage: Intelligence and wilderness survival only.
 Mechanical: Any
 Medical: Any (+10%)
 Military: None
 Physical: Any
 Pilot: Any
 Pilot Related: Navigation and Sensor Operation only.
 Rogue: None
 Science: Any (+10%)
 Technical: Any (+10%)
 W.P.: Civilian weapons only.
 Wilderness: Any

Warlord Nightbane Skill Package

The character is (or was) a member of the Nightbane controlled Warlords. Or he might have been a gang member before changing from latent into a full-fledged Nightbane. The character has a number of street-survival skills, but little in the way of advanced education.

R.C.C. Skills

Basic Math (+5%)
 Speak Native Language; Literacy must be selected as an "other" skill (+10%)
 Streetwise (+15%)
 Prowl (+10%)
 Pick Locks (+15%)
 Running
 Two W.P.s (any)
 Hand to Hand: Basic
 Hand to hand: basic can be changed to expert at the cost of one "other" skill or to martial arts or assassin for two "other" skills.

Related Skills: Select six other skills. Plus select two skills at levels two and five, and one at levels eight and twelve.

Communications: Radio: basic only.
 Domestic: Any
 Electrical: Any
 Espionage: Any (+5%) except disguise, tracking, sniper, and wilderness survival.
 Mechanical: Any
 Medical: First Aid only.
 Military: Any
 Physical: Any (+5% when applicable)
 Pilot: Automobile, motorcycle, truck and motorboat only (+5%).
 Pilot Related: None
 Rogue: Any (+10%)
 Science: None
 Technical: Any
 W.P.: Any
 Wilderness: None

Trained Nightbane:

Nocturne/Seeker/Lightbringer Skill Package

A character who is a member of the more magic and/or scholastically oriented groups. These Nightbane will have a broad range of knowledge and technical/scientific skills. Or the character might have been a graduate student in any scholastic or scientific field when he changed.

R.C.C. Skills

Basic Math (+20%)
 Advanced Math (+10%)
 Native Language and Literacy (+30%)
 Two Languages of Choice (Literacy and Spoken) (+10%)
 Computer Operation (+20%)
 Two related Science or Technical Skills of choice (+15%)
 Nightbane Lore (+15%)
 Hand to hand combat must be selected as an "other" skill.
 Hand to hand: basic costs one skill selection. Expert counts as two, and martial arts or assassin count as three skill selections.

Creating the Nightbane

One of the unique characteristics of the Nightbane is that they have no set shape or qualities. There are literally thousands of variations, and it is said that no two Nightbane are exactly alike. In general, the Nightbane's Morpheus (true form) will reflect some part of the character's personality. For example: a character who was fascinated (or afraid) of snakes might turn into a were-snake creature or have scaly skin or a serpent's tongue. A shy and/or unattractive character might actually transform into an awesomely beautiful, albeit inhuman, form, or see himself as a monster and turn into a hulking beast.

To simulate the variety of forms, a number of **Appearance and Shape Tables** have been set up in the following section. *Random rolls* to select the appearance, abilities and limitations of the Nightbane is, in many ways, the easiest and always fun. This method is quick, but may leave the player unsatisfied with the results for his character. On the other hand, play-tests determined that it was fun to decide why the character's Morpheus looked like the randomly-rolled result. It turned out to be similar to interpreting a horoscope or Tarot Reading, and it actually gave players some ideas and insights on how to role-play their character.

Game Masters may alternatively allow the players to pick some selections and randomly roll on others: For example, the aforementioned character who is fascinated by snakes would get to *select* the Snake Form Table, and roll randomly to see what snake characteristics would occur. The combination works best if the player has an idea of what kind of Nightbane he'd like to play, but wants some randomness to add spice.

The last way is to simply hand-pick the selections the player wants for his or her character. This option can lead to abusive players trying to design super-powerful Nightbane and "killing machines" without regard for balance or role-playing, so the Game Master is cautioned not to use it unless his players are not likely to abuse their freedom, or he is not particularly concerned with game balance — and let's face it, fun may come ahead of both game balance and realism; although the **Nightbane RPG** can be used for moody, "dark" and introspective games, it can also be a "supernatural superhero" game (and lots of things in between); it's up to you.

Creating New Tables/Forms: Even all the tables below can't hope to compete with the imaginations of players and Game Masters. More tables and ideas for new forms and features will appear in future **Nightbane** supplements. As usual, these tables are provided as guidelines; thus a player may randomly roll for appearance and shape, make deliberate selections, or come up with his own (subject to G.M. approval). Game Masters and players are encouraged to add their own forms and concepts to the mix.

Game Masters and Players Note: Flexibility and imagination are the key. If a combination of rolls produces a ridiculous result, the description could be altered to fit the player's conception or rerolled. Players should get a Nightbane character they enjoy playing, but they shouldn't try to optimize their characters and turn them into ultra-powerful beings. Game Masters might



decide to put a “cap” on the number of attribute and S.D.C. bonuses if they feel their players are just trying to stack bonuses for the sake of power. Also, if the game is meant to have a serious bent, “silly” or humorous forms shouldn’t be allowed (on the other hand, a touch of humor might be appropriate for some campaigns). Don’t let die rolls rule the game. Be imaginative and have fun.

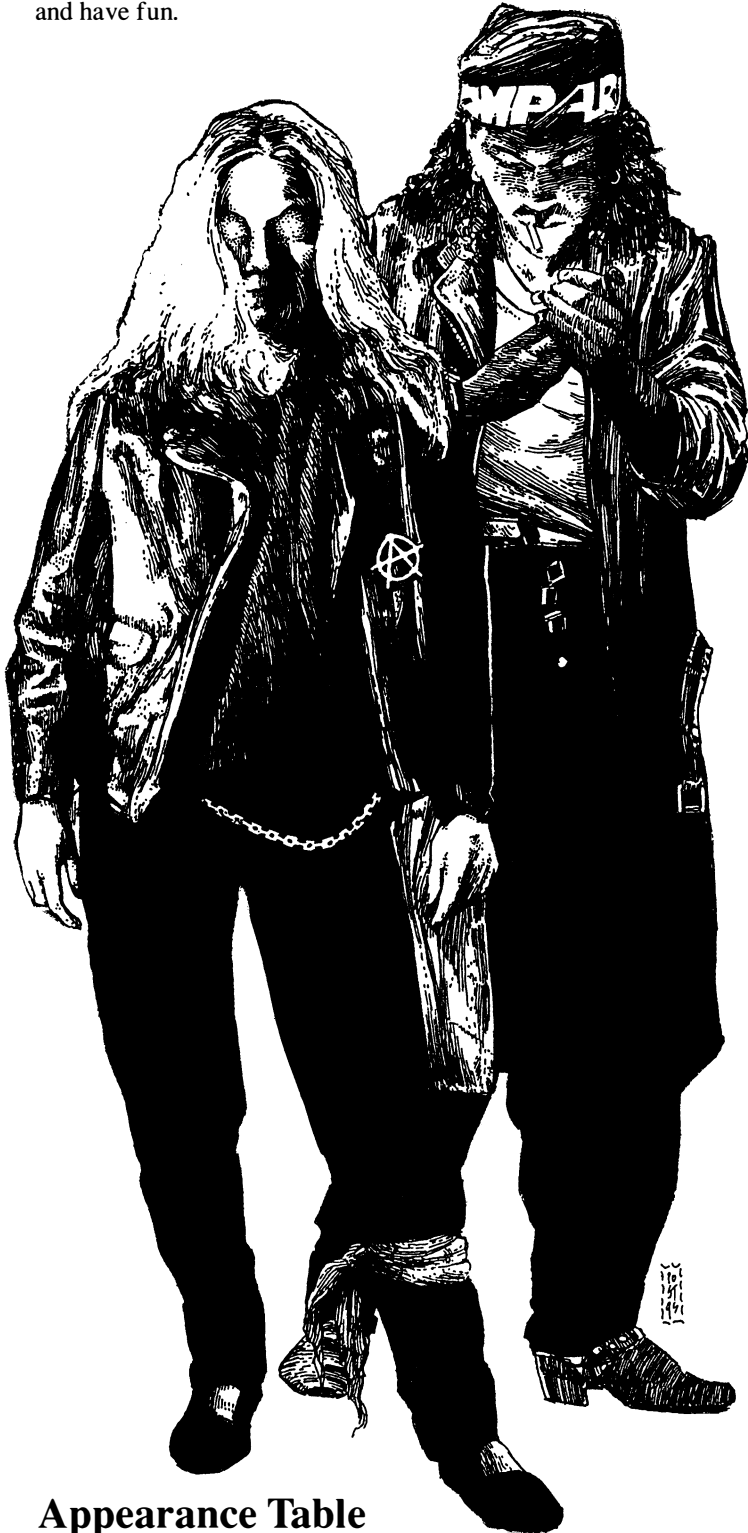

Appearance Table

Roll or select one.

01-20% — Almost human: The Nightbane’s Morphus is almost totally human, except for one inhuman trait that might be disguised or concealed — although sometimes the one trait is inhuman enough to give away the character’s true supernatural na-

ture. Roll once on the *Nightbane Characteristics Table* to determine unusual characteristics. If the result asks for more than one characteristic, ignore it and reroll.

21-30% — Inhuman but beautiful: The Nightbane combined a beautiful appearance with rolls on the *Unearthly Beauty Table* and the *Nightbane Characteristics Tables*.

31-45% Marred Beauty: The character has a beautiful True Shape, but it is marred by a gruesome stigmata. Make rolls on the *Unearthly Beauty Table*, the *Stigmata Table*, and the *Nightbane Characteristics Table*.

46-60% Lycanthrope: The Nightbane’s Morphus is a mixture of animal and humanoid traits. Roll once on the *Animal Form Table*.

61-75% Monstrous Lycanthrope: Not only is the Morphus form animal-like, it has hideous deformities that give it a terrifying appearance. Roll on the *Animal Form*, *Stigmata* and *Nightbane Characteristics Tables*.

76-90% Inhuman Shape: The Nightbane’s True Shape is a gruesome mockery of humanity. Roll on the *Stigmata* and *Nightbane Characteristics Table*.

91-00% Bizarre: Roll on the *Unearthly Beauty*, *Nightbane Characteristics*, *Animal Form*, and *Stigmata* tables. Then exercise your imagination to combine the alien result.

Nightbane Characteristics Table

01-20% Unusual Facial Features: Roll on the *Unusual Facial Features Table*.

21-40% Biomechanical: Roll on the *Biomechanical Table*.

41-60% Alien Creature: Roll on the *Alien Shape Table*.

61-80% Unnatural Limbs: Roll on the *Unnatural Limbs Table*.

81-90% Two characteristics: Roll or select two categories. Ignore any result of 61% or higher (alternatively, roll 1D6×10% to get a result between 10-60%). If you get the same characteristic twice, roll twice on the appropriate table.

91-95% Three characteristics: Roll or select three categories. Ignore any result of 61% or higher (alternatively, roll 1D6×10% to get a result between 10-60%). If you get the same characteristic twice, roll twice on the appropriate table.

96-00% Four Characteristics! As above, but roll four times.

Unearthly Beauty Table

Not all Morphus are horrible to behold. Some have a terrible beauty that produces fascination and awe instead of fear or loathing. Nightbane students are divided as to whether these shapes are the result of inner beauty brought to the fore, or an incarnation of some darker facet of the Nightbane’s personality. Although there aren’t any statistical figures to confirm this, it is widely believed that more female Nightbane have beautiful qualities than their male counterparts. The argument is that females are more concerned about their appearance, and this comes through when their Morphus manifests. Modern-minded Nightbane consider this to be so much male chauvinism and ignore it.

Beautiful Nightbane are often met with anger and contempt by others of their kind. The current nickname for attractive and not terribly deformed Nightbane is “Barbie” or “Ken” (some of the older Nightbane use “Venus” or “Adonis” instead). The “Barbies” inspire a great deal of jealousy among some Nightbane, who feel they got the short end of the stick. Also, a few “Barbies” claim that their beauty is the result of their purer or superior spirits or souls which does not endear them to the rest.

01-10% Doll-Like Appearance: The Nightbane’s body is small and toy-like. His or her skin becomes unnaturally smooth and featureless (no fingerprints), size is reduced by 2D6+10 inches (0.3 to 0.55 m), and body temperature is inhumanly cold. The character’s P.B. is raised by 6 points and from a distance, the character will be mistaken for a small child. If standing perfectly still, he or she might pass as a storefront mannequin. In a good light, the inhuman features of the Nightbane have a frightening aspect, providing a Horror Factor of 10.

11-30% Animal Magnetism: The Nightbane’s P.B. and M.A. are increased by 8 (minimum P.B. and M.A. is 20!). Not only is his/her Morphus incredibly beautiful, it radiates charisma. This is a mixed blessing, however, for the attraction the character exerts cannot be turned off. This can lead to a number of distractions, annoyances and even hazards, as total strangers make advances towards the character, or try to force their affections on him/her.

31-50% Elf Features: The character has slender and delicate features, oversized eyes and vaguely pointed ears, reminiscent of the legends of elves and faerie. Increase P.B. by 7 points (minimum 17) and size by 1D6 inches. Their unusual appearance has Horror Factor 6.

51-70% Physical Perfection: The Nightbane’s True Shape is at the peak of physical condition, with perfectly delineated muscles and a shape somewhere between a gymnast and a bodybuilder. Increase P.B., P.E. and P.S. by 1D4 each and S.D.C. by 4D6. The character projects an aura of danger that intimidates those around him, giving the Nightbane a base Horror Factor of 6.

71-90% Fallen Angel: A Nightbane with inhuman beauty; increase P.B. by 6 and S.D.C. by 3D6. Fallen angels also have feathered wings on their backs which provide a slow flying (Speed of 4D6 in the air ability).

91-95%: Combination of Two: Roll two times (ignore and reroll any result of 91% or higher) and combine the two results.

96-00% Other: The Game Master and player can develop a different form of unearthly beauty. The physical attractiveness could be balanced by an inhuman or intimidating feature. Alternatively, roll three times, and combine the results, as per 91-95%.

Animal Form Table

About one-third of Nightbane have animal shapes or characteristics in their Morphus. In earlier times, the animal characteristics were even more common, so these transformed Nightbane were believed to be the living embodiments of their animal totems or were-beasts. Animal shapes seem to reflect parts of the Nightbane’s personalities. For example, a strong-willed person (or, often, somebody who wants to be strong but was not in his normal life) could turn into a bear or wolf-like

creature. Free-spirited wanderers often take on the forms of birds and other fliers. Curious, coy or feminine people may have feline qualities, sneaky or weaselly fellows may have the characteristics of a weasel or rodent, and so on. Other forms just seem to be the result of interests and hobbies: many an insect collector has turned into a giant equivalent of a prized specimen! Warrior types often transform into wolf, lion or tiger form, while city-rats might actually become so in literal truth!

Even while rolling randomly, deciding what aspect of the character has been reflected in the Morphus might provide ideas on the specifics. The actual animal species is left to the player’s discretion. If the player rolls a Canine Form, is his character a wolf (warrior, team player), a dog (loyal companion, guardian), or a fox (wily trickster)?

All animal forms are capable of full human speech; the words may be twisted by the Nightbane’s inhuman shape, or they could be perfectly human-like (player’s choice). Hearing words coming from an animal adds +1 to the Horror Factor of the creature the first few times, until the person gets accustomed to it.

01-07% Bear: All large ursinoids. Roll on the *Bear Table*.

08-14% Amphibian: Mostly frogs and toads. Roll on the *Amphibian Table*.

15-20% Insectoid: All types of insects, from beautiful butterflies to disgusting dung beetles. Roll on the *Insectoid Table*.

21-27% Rodent: Rats, squirrels, beavers and similar creatures. City-bred Nightbane tend to favor rats, while those who grew up in the country often transform into wilderness varieties. Roll on the *Rodent Table*.

28-35% Arachnid: Spiders and scorpions. Roll on the *Arachnid Table*.

36-44% Bat: All varieties of pointy-eared flying mammals, including vampire bats, fox-bats, and others. Roll on the *Bat Table*.

45-53% Feline: All cats, from the great predators to small house cats. Roll on the *Feline Table*.

54-62% Snake: All crawling, non-legged, scaly creatures, from the huge anaconda to the tiniest garden snake. Roll on the *Snake Table*.

63-71% Avian: Any bird species can be selected (most of them are predatorial or scavenging birds, however). Roll on the *Avian Table*.

72-79% Canine: Dogs, wolves and foxes. Roll on the *Canine Table*.

80-88% Reptilian: Lizards (snakes have their own table) of all kinds. Roll on the *Reptilian Table*.

89-95% Equine/Bovine/Deer: Includes not only horses and cows, but all kinds of hoofed plant-eaters such as goats, deer, antelope, zebras, etc. Roll on the *Equine/Bovine/Deer Table*.

96-98% Combination of Two! Roll twice on this table (ignore and reroll any result of 96% or higher), and combine the elements from the two animals. To decide which bonuses apply, roll 1D6; 1-3 means the first animal selection is used, 4-6 means the second one is. **Example:** A Nightbane has snake and equine characteristics. The player decides the character is a centaur with a were-snake upper body. When selecting P.S. bonuses, the player rolls 1D6, on a roll of 1-3, he gets the snake P.S. bonuses; on a roll of 4-6 he gets the Centaur/horse P.S. bonuses.

99-00% Combination of three! Roll three times (ignore and reroll any result of 96% or higher) and combine elements from the three animals. To decide which bonuses apply to each attribute, roll 1D6: 1-2 means the first animal selection is used, 3-4 means the second one applies, and 5-6 grants the bonuses of the third selection.

Arachnid Table

Spiders and scorpions are living symbols of alienness. Nightbane whose Morphi have arachnid elements often felt like outsiders even before their Becoming. Spider Nightbane are often good schemers who like to spin complex webs of intrigue, for good or ill. Scorpion beings tend to be vicious predatorial types, stubborn and unwilling to compromise. Due to the natural human revulsion towards these creatures, they are among the most fearsome Nightbane forms. All arachnid characters instinctively have the base skills of climb at 55% and prowl at 25% whenever they change into their Morphus shape.

01-20% Full Arachnid: The Nightbane's Morphus is a giant spider or scorpion. In either case, the creature gets the following bonuses: +4 to P.S., +2 to P.P., +2 to P.E., +1D4×10 to Speed (can leap 20 feet/6.1 m), and +3D6×10 S.D.C., +2 on initiative and +1 on perception rolls. Add 6 to Horror Factor.

If a spider, the Nightbane can spin and shoot webbing (range: 60 feet/18.3 m, with 4D6 S.D.C. per length/application), bites inflict 2D4 plus injects a poison inflicting 4D6 S.D.C. (2D6 S.D.C. if a save versus lethal poison is made).

If a scorpion, pincers add one attack per melee round, do 3D6 S.D.C. hand to hand damage, and the stinger inflicts 3D6 S.D.C. plus it injects poison (same stats as spider's poison, above).

21-45% Were-Arachnid: A vaguely humanoid creature, with two legs and six arms if a spider, or two legs, two arms, two additional arms with pincers, and a tail/stinger if a scorpion. The head is an inhuman horror with four to six eyes, pincer-mouth and chitin or spider-fur instead of skin. The creature could never be confused for a normal human. Bonuses: +2 to P.S., +2 to P.P., +2D6 to Speed (can leap 10 feet/3.0 m), and 2D4×10 to S.D.C. +1 on initiative and +1 on perception rolls; add one additional attack per melee from the extra limbs. Add 1D4+2 to the Horror Factor.

If it is a spider shape, the Nightbane can spin and shoot webbing (range: 60 feet/18.3 m, has 3D6 S.D.C. per application), and its bite inflicts 1D6 plus injects a poison inflicting 4D6 S.D.C. (2D6 S.D.C. if a save versus lethal poison is made).

If a scorpion, pincers add 2D6 to hand to hand damage, and the stinger inflicts 3D6 S.D.C. plus it injects poison (same stats as spider's poison, above).

46-70% Humanoid-Arachnid: A "man-spider" or "man-scorpion," with a mostly humanoid shape, but with chitin or hair-covered skin, clawed hands, and either two additional spider-arms, or a scorpion's stinger. Bonuses: +2 to P.S., +1 to P.P., +1D6 to Speed (can leap 6 feet/1.8 m) and +1D6×10 S.D.C. Add 1D4 to Horror Factor.

If a spider, add one additional attack per melee round from the extra arms; the clawed limbs inflict 3D6 in addition to hand to hand damage.

If a scorpion, add one additional attack per melee round from the stinger which inflicts 2D6 S.D.C. plus poison that does 4D6 S.D.C. (2D6 S.D.C. if a save versus lethal poison is made).

71-90% Scorpion Pincers/Spider Limbs: The character has a normal human shape — except for the hands, which are tipped by either pincers or bony, hair covered fingers tipped with claws. The character's face also has a strangeness to it; the look of a predator always sizing-up its prey. Bonuses: +2 to P.S., +1 to P.E., +3D6 to S.D.C. The pincers inflict 3D6 in addition to normal hand to hand damage, spider-clawed hands do 2D6 damage. On the down side, the Nightbane's hands cannot grasp tools and weapons properly: -5 to use them and -30% in skill proficiencies that require dexterity and sensitive touch. Add 1 to Horror Factor.

91-00% Spider/Scorpion Centauroid: The Nightbane is a huge creature with the lower body of a spider or a scorpion, and the upper body of a humanoid-arachnid. The result is much taller and heavier than a normal human, making it difficult to fit into vehicles and enclosed spaces. Add +2 to P.S. +2 to P.P., +1 to P.E., +3D6 to Spd (can leap 12 feet/3.6 m), and +3D6×10 to S.D.C. Add 1D6 to Horror Factor.

If a spider, the Nightbane can spin and shoot webbing and its bite inflicts 2D4 S.D.C. plus injects a poison the same as the giant spider.

If a scorpion, pincers add 3D6 to hand to hand damage, and the stinger inflicts 3D6 S.D.C. plus it injects poison (same stats as spider's poison, above).

Avian/Bird Table

The player gets to select the bird's species. Nightbane tend to become predatorial or scavenger birds, although all kinds are possible. Avian Nightbane are often wanderers by heart, or those who covet the freedom to fly away from one's problems.

01-15% Full Bird Form: The character has almost no humanoid features, and basically appears as a giant bird of the player's choice. +1 P.S., +3 P.P., +3D6 S.D.C. Speed flying is 2D6×10. Exceptional vision (can see a rabbit, or read a sign two miles/3.2 km away): +2 to initiative and +3 to all perception rolls using sight. Beak slash/peck does 3D6 S.D.C. plus P.S. bonus. Feet claws add 1D6 S.D.C. to kick damage. While in this form, the Nightbane cannot manipulate guns and normal weapons (arms have been replaced by wings); most skills requiring manual dexterity will be at -40%. Add 1D4 to Horror Factor.

16-30% Were-Bird: The Nightbane is a bird-man (or woman), with hands at the end of the wings, a full bird's head, clawed feet, and a feather-covered body. +2 P.S., +2 P.P., +3D6 S.D.C. Speed flying is 2D4×10. Exceptional vision: +2 to initiative, and +2 to all perception rolls using sight. Beak slash/peck does 2D6 S.D.C. plus P.S. bonus. Feet claws add 1D6 S.D.C. to kick damage. While in this form, guns and hand weapons are at -4 to strike. Skills requiring manual dexterity will be at -25%. Add 1D6 to Horror Factor.

31-45% Man-Bird: The character has separate wings and arms, and fully developed hands ending in claws. The body is still covered by feathers, and the character has a small beak, nearly useless in combat. +2 P.S., +2 P.P., +3D6 S.D.C. Exceptional vision: +1 on initiative, and +2 to all perception rolls using



sight. Beak bite does 1D4 S.D.C. (no P.S. bonus). Speed flying is 1D6×10 and add 1D6 to Horror Factor.

46-55% Bird Head: The character looks like a normal human, except for his head, which is that of a bird's. Beak slash inflicts 3D6 S.D.C. plus P.S. bonus. Exceptional vision: +1 on initiative and is +2 to all perception rolls using sight. Add 1D6 to Horror Factor.

56-66% Bird Face: The Nightbane looks like a normal humanoid, except for large round eyes and an oversized beak protruding from where his mouth and nose would be! Beak slash does 3D6 S.D.C. plus P.S. bonus. Add 1D4 to Horror Factor and +1 on initiative.

67-80% Talons: The character's hands and feet turn into oversized bird-like talons. Add +1 to P.S. Claws add 2D4 to punch and kick damage. Add 1D4 to Horror Factor. Normal shoes and gloves are uncomfortable and painful to wear.

81-90% Feather "Hair": Instead of hair, the character's head is covered by feathers. Small feather growths appear throughout the body. Add 2D6 to S.D.C. and +1 to Horror Factor,

91-00% Winged Human: A normal-looking human, except for the wings protruding from the back. The wings can belong to any bird species. Add 2D6 to S.D.C., +1 to P.B., and the character can fly at a speed of 1D4×10.

Bat Table

Bat-like Nightbane have often been confused with vampires and demons. It may not be an accident that many Nightbane with such Morphi were fascinated with creatures of the night before the Becoming. During Dark Day, many an Anne Rice fan found himself or herself turned into something beyond the vampire tales' wildest imaginings. While vampire bats seem to be dominant among these Nightbane, all bat species can be found in one shape or another. All bat characters instinctively have the base skills of climb at 45% and prowl at 20% whenever they change into their Morphis shape.

01-20% Full Bat: The Nightbane has the shape of a giant bat, typically with a wingspan of over seven feet (2.1 m)! This Morphis has +2 to P.S., +2 P.E., +4 to P.P., a flying speed of 1D6×10+20, and +2D4×10 to S.D.C. Ultra-acute hearing adds +3 to initiative and +4 to any perception rolls involving sound, and unlike true bats, the Nightbane's vision is not impaired (same as a human's). Its arms are giant leathery wings with hands at the middle joint. This limits the character's ability to manipulate tools and use weapons (-6 to strike, -35% to perform skills; both are impossible when flying), although it can carry small objects in its hands or large items or people in its prehensile clawed feet. The clawed feet inflict 2D6 S.D.C. plus hand to hand damage, and its bite does 2D6 S.D.C. Add 1D4 to Horror Factor.

The bat form is also capable of using its screeching as a form of radar, allowing it to sense invisible figures and obstacles concealed in total darkness, fog, smoke, etc. Range is 500 feet (152 m).

21-40% Were-Bat: This Morphis is more human-like, although still predominantly bestial. The Nightbane is covered with fur, and its head is animalistic, with a snout and the oversized ears of a bat. Instead of arms it has full bat-wings, but they end in large, clawed hands that can be used to grasp objects and use tools or weapons (-3 to strike, -15% to perform skills; neither can be done while flying). Bonuses: +3 to P.S., +3 to P.P., +3 to P.E., and the character has a flying speed of 1D6×10. +1D6×10 S.D.C. Ultra-acute hearing adds +1 to initiative and +3 to any perception rolls involving sound. Unlike true bats, the Nightbane's vision is not impaired. The bat form is also capable of using its screeching as a form of radar/sonar, allowing it to sense invisible figures and see with obscured vision at a range of 200 feet (61.0 m). Claws on hands and feet inflict 2D4 S.D.C. in addition to normal hand to hand damage. Bite does 2D4 S.D.C. Add 1D6 to Horror Factor.

41-60% Humanoid Bat: The Nightbane's skin is sparsely covered by fur, and the face and features are mostly humanoid, with pointy but small ears and sharp fangs marring an otherwise normal face and head. Small bat-wings extend from beneath the arms, making normal clothing very uncomfortable to wear (the wings can be folded, but this restricts movement). Bonuses: +2 to P.S., +1 to P.P., and limited flying speed of 1D4×10. +1D4×10 to physical S.D.C., Acute hearing adds +2 to any per-

ception rolls involving sound; the Nightbane does NOT have the bat's sonar sense. Claws on hands inflict 1D6 S.D.C. in addition to normal hand to hand damage. Bite does 1D6 S.D.C. Add 1D4 to Horror Factor.

61-80% Bat Wings: The Nightbane looks like a perfectly normal human — except for the bat wings protruding from his/her back, which give him a demonic appearance. The wings allow for flight at a speed of 1D6×10 and +1 to dodge when flying. Add 4D6 to S.D.C., and +2 to Horror Factor.

81-00% Bat Head: A normal human body, topped by a perfect bat's head. Add 2D6 to S.D.C. Ultra-acute hearing adds +2 to initiative and +4 to any perception rolls involving sound. Unlike true bats, the character's vision is not impaired. The bat form is also capable of using its screeching as a form of radar, allowing it to sense invisible figures and see in total darkness, fog or smoke at a range of 500 feet (152 m). Bite inflicts 2D6 S.D.C. Add +2 to Horror Factor.

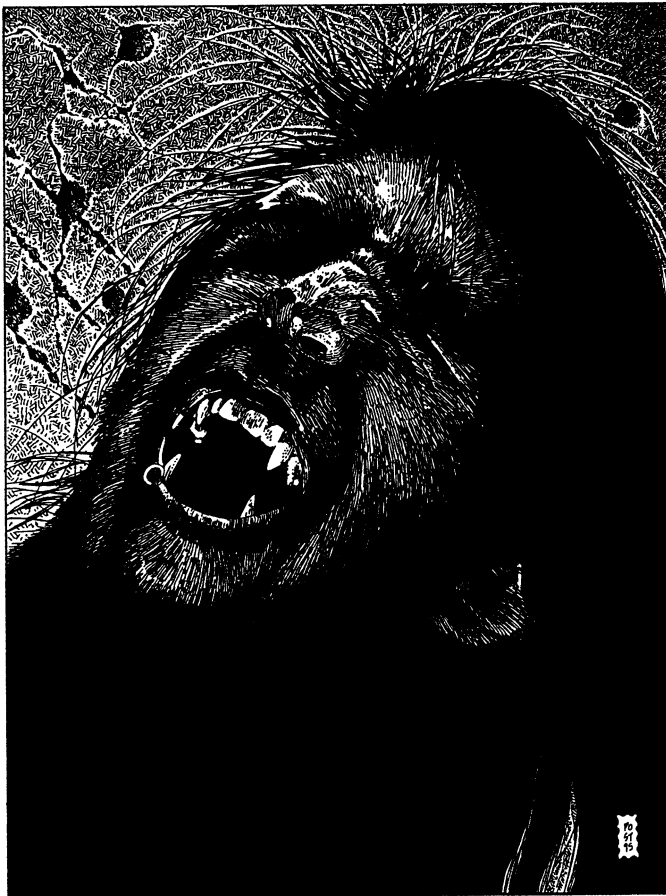

Canine Table

The choice of the specific canine species is left to the player. Wolves are the most common canine Nightbane, but dogs of all types, foxes and other canines, are possible. Wolf-like Nightbane are often leaders or team players, fiercely loyal to their "pack." Dogs have so many varieties that almost any personality or attitude can be reflected by one or more species, from bestial savagery (a pit bull or a Doberman) to dependable companionship (St. Bernard). Fox Nightbane are typically tricksters; they have been fairly common in Japan, perhaps due to the legends of fox-spirits. All canine characters instinctively get a base skill of track at 40% and swim at 50% whenever they change into their Morphus shape.

01-20% Full Canine: The Nightbane's Morphus is a large canine, commonly a huge wolf or dog that can pass for a normal member of the species unless other Nightbane characteristics apply. Bonuses: +5 to P.S., +1 to P.P., +3 to P.E., 2D6×10 to S.D.C., and Speed is raised by 12 points. Superior sense of smell and hearing adds +1 to initiative and +3 to perception rolls, and +15% to the tracking skills (if the character does not have a tracking skill, he automatically has it at +15% in his Morphus alone). Bite attacks do 5D6 S.D.C. and the wolf form can body-slam enemies (inflicts the equivalent of punch damage), but it cannot punch, kick, or use weapons or tools. Add +2 to Horror Factor.

21-45% Were-Canine: A humanoid-canine with full dog/wolf features, covered in fur, with a tail, and bigger than a normal human. Bonuses: +4 to P.S., +1 to P.P., +3 to P.E., and 2D4×10 to S.D.C. A bite attack does 4D6 S.D.C. and claws add 2D4 S.D.C. to hand to hand damage. Speed is raised by 6 points. +2 initiative and perception rolls are at +2. +10% to the tracking skills (if the character does not have a tracking skill, he automatically has it at +10% in his Morphus). Add 1D4+1 to horror factor.

46-70% Canine Humanoid: A less extreme version of the above, the character resembles the "wolf-man" of classical movies. The Nightbane has no snout or tail, but is covered in fur and has fangs. Heavy clothing could disguise his appearance to some degree (close up or when clearly visible in a good light, however, it would be obvious that this isn't a normal human being). Bonuses: +2 to P.S., +2 to P.E., +3 to Speed (and can leap 12 feet/3.6 m high or lengthwise), 1D4×10 to S.D.C., and +1 initiative and +1 to perception rolls. Bite does 2D6 S.D.C. and claws add 1D6 S.D.C. to hand to hand damage. Add 2 to Horror Factor.

71-80% Canine Centauroid: The Nightbane has the upper body of a were-canine (as above) and the lower body of a wolf! This four-legged creature is too big to fit inside most automobiles and may not fit in an elevator and other confined spaces. Bonuses: +6 to P.S., +4 to P.E., 2D6×10 to S.D.C., +1 to initiative and +2 to perception rolls. Its bite inflicts 4D6 S.D.C., and claws add 2D4 to hand to hand damage. Speed is raised by 4 points. Add 1D4 to Horror Factor.

81-00% Canine Head: A normal looking human with the head of a wolf or a dog! Bite inflicts 4D6 S.D.C., and the character has +1 on initiative and +2 to perception rolls. Add 1 to Horror Factor.

Equine/Bovine/Deer Table

This table covers most four-legged herbivores, from domestic cattle to wild deer, bison, antelopes and similar species. Horses and cattle have often been thought of as symbols of power and strength, as well as friends to humankind. The most common Nightbane shapes with these bovine or equine characteristics are the centaur and minotaur. It is very likely that the Nightbane gave birth to the legends of the mythical half-man, half-horse (or half-bull). A few Nightbane even transform into normal-looking animals, which may explain stories of magical horses or woodland creatures.

Note: Damage (unless otherwise indicated) is as follows: Kicks and head butts inflict double damage (typically 2D6 +P.S.

bonus) and jump and leap kicks do triple damage! If a horned/antlered creature, the Nightbane can head-butt and inflict 4D6 damage. All equine/bovine/deer Nightbane instinctively know how to swim at a base proficiency of 65% and climb at 30%.

01-20% Full Horse/Bovine/Deer Form: The Morphus form is that of a huge creature of the species in the list. The character may pass as a normal animal, although bigger than average and has a mean or tough appearance. Bonuses: +12 to P.S., +3 to P.P., +6 to P.E. and +1D6×10 to running speed. The character can also leap 10 feet (3 m) high or 15 feet (4.6 m) lengthwise and gets an automatic dodge (works like a parry and does not use up a melee attack/action). +3D6×10 to S.D.C. The character cannot use any weapons or tools, and may be too large to fit into most vehicles. +1 on initiative and +2 on perception rolls. Add 1D4 to Horror Factor.

21-45% Half-Man, Half-Animal/Were-Animal/Minotaur: The character has the basic bipedal shape of a muscle-bound human, but is covered with fur, has hooved or cloven feet, a tail, and the head of a horse, bull, deer, or similar animal (the bull is the traditional minotaur of myth and legend). Bonuses: +6 to P.S., +2 to P.P., +4 to P.E., and +4D6 to running speed. +2D6×10 to S.D.C. kicks and horn attacks inflict an additional 2D6 S.D.C. damage. +2 on initiative. Add 1D4+2 to Horror Factor.

46-66% Humanoid Shape: A less extreme version of the above, with a basically human form. Typically, the chest and arms are completely human, but the character has fur-covered legs and hooved/cloven feet. The head is mostly humanoid, but is likely to have horns or antlers and animal features (large eyes, long face, large flat teeth, etc.). These Nightbane may be responsible for myths about satyrs and the god Pan. Bonuses: +4 to P.S., +1 to P.P., +2 to P.E., and +2D6 to running speed. +1D6×10 to S.D.C. +1 on initiative and perception rolls. Add 1D4 to Horror Factor.

67-90% Centaur/Beast-Man: The character has the lower body of a horse, deer, moose, bull, or similar animal and the upper body of a normal man, with horns or antlers crowning the man's head. Bonuses: +6 to P.S., +2 to P.P., +5 to P.E., and +5D6 to running speed. +3D6×10 to S.D.C. The Nightbane's body may be too big to fit in vehicles or to maneuver well in most indoor settings. +2 on initiative and perception rolls. Add 1D4 to Horror Factor.

91-00% Equine/Bovine Head: A normal-looking human body with a full animal head. Bonuses: +1 to P.S., +1D6 to speed, +3D6 to S.D.C. and +1 on initiative and perception rolls. Add 1D4 to Horror Factor.

Feline Table

The player gets to select the features of a cat. Any feline, from prehistoric sabertooth tigers to household tabbies can be selected. Independent, lazy or sensual Nightbane tend to have some feline elements in their Morphus. Feline Nightbane may have triggered the persecution and killing of cats during the Middle Ages (especially during plague years) when cats were believed to be demonic creatures who had brought plague and disease to the world.

All feline characters automatically get a bonus of +2 to roll with fall or impact and instinctively get a base skill of climb at 45%, swim at 40% and prowl at 20% whenever they change into their Morphus shape.

01-10% Full Feline Form: The Nightbane becomes a large (or in the case of household cats, a giant) version of the species in question. +6 P.S., +3 P.P., +3 P.E., +3D6×10 S.D.C., nightvision is extended to 1000 feet (305 m), acute hearing adds +2 to initiative and perception rolls involving sound. Claws add 2D6 S.D.C. damage to supernatural strength. Bites inflict 4D6 S.D.C. Running speed is increased by 1D6×10, and the character can leap 30 feet (9.1 m) from a standing position and 60 feet (18.3 m) with a running start! The feline cannot use any weapons, tools or vehicles. Add 1D4 to Horror Factor.

11-26% Were-Cat: A humanoid feline creature, covered in fur and with full feline-shaped head and tail. +4 to P.S., +2 to P.P. and P.E., +2D4×10 S.D.C., +1D4×10 speed. Nightvision is extended to 1000 feet (305 m), acute hearing adds +2 to initiative and perception rolls involving sound. Claws add 2D4 S.D.C. to supernatural strength damage. Bite inflicts 3D6 S.D.C. Can leap 20 feet (6.1 m) from a standing position and 40 feet (12.2 m) with a running start. The paws make it hard to use weapons and tools: -4 to strike with guns and -20% (or -4) to use any weapons, tools or skills that require manual dexterity. Add 1D6 to Horror Factor.

27-42% Fur-Covered Humanoid: The Nightbane could pass for human in bad light, but his/her skin is covered with fur, the ears are feline and near the top of the head, the teeth are sharp feline fangs, has a long furry tail, and the eyes have vertical slits. Add +2 to P.S. and P.P., +1D6×10 to S.D.C., +3D6 to Speed. Claws add 1D6 S.D.C. to supernatural damage. Bite inflicts 2D6 S.D.C. Nightvision is 800 feet (243.8 m), and acute hearing adds +1 to initiative and +2 to perception rolls involving sound. Add 1D4 to Horror Factor.

43-58% Cat-like: Appears to be a normal person except for the eyes, which have vertical slits, the teeth (unnaturally long and sharp), and the retractable claws in the hands and feet. Add +1 to P.P. and +1D6 to Speed. Nightvision is 800 feet (243.8 m) and acute hearing adds +1 to perception rolls involving sound. Claws add 1D6 S.D.C. to supernatural damage. Bite inflicts 2D6 S.D.C. Add 1D4 to Horror Factor.

59-69% Feline Centauroid: The creature has the lower body of a giant cat, and the upper body of a were-cat! The Nightbane is almost as big as a horse, and cannot fit in most regular vehicles, elevators and even some doorways! Add +2 to P.P., +6 to P.S., +4 to P.E., and 3D6×10 to S.D.C. Speed is increased by 1D6×10. Claws add 2D6 S.D.C. damage to supernatural strength and bites inflict 3D6 S.D.C. Running speed is increased by 1D6×10 and the creature can leap 30 feet (9.1 m) from a standing position and 60 feet (18.3 m) with a running start. Add 1D6 to Horror Factor.

70-80% Cat Claws: The Nightbane gains retractable claws (add +5% to Climbing rolls) and inflicts 2D4 S.D.C. in addition to normal P.S. damage.

81-90% Cat's Head: The Nightbane has a normal humanoid body but his head is fully feline! Nightvision is 600 feet/183 m. Bite inflicts 4D6 S.D.C., +1 on initiative and +1D4 to Horror Factor.

91-00% Feline Features: A lesser form of Cat's Head (see above), in which only some of the person's features have a feline look. The character gains sharp teeth (bite inflicts 1D8 S.D.C. damage), cat's eyes with vertical slits (add +1 to perception rolls, nightvision is 500 feet/152 m), and furry, pointed ears near the top of the head.

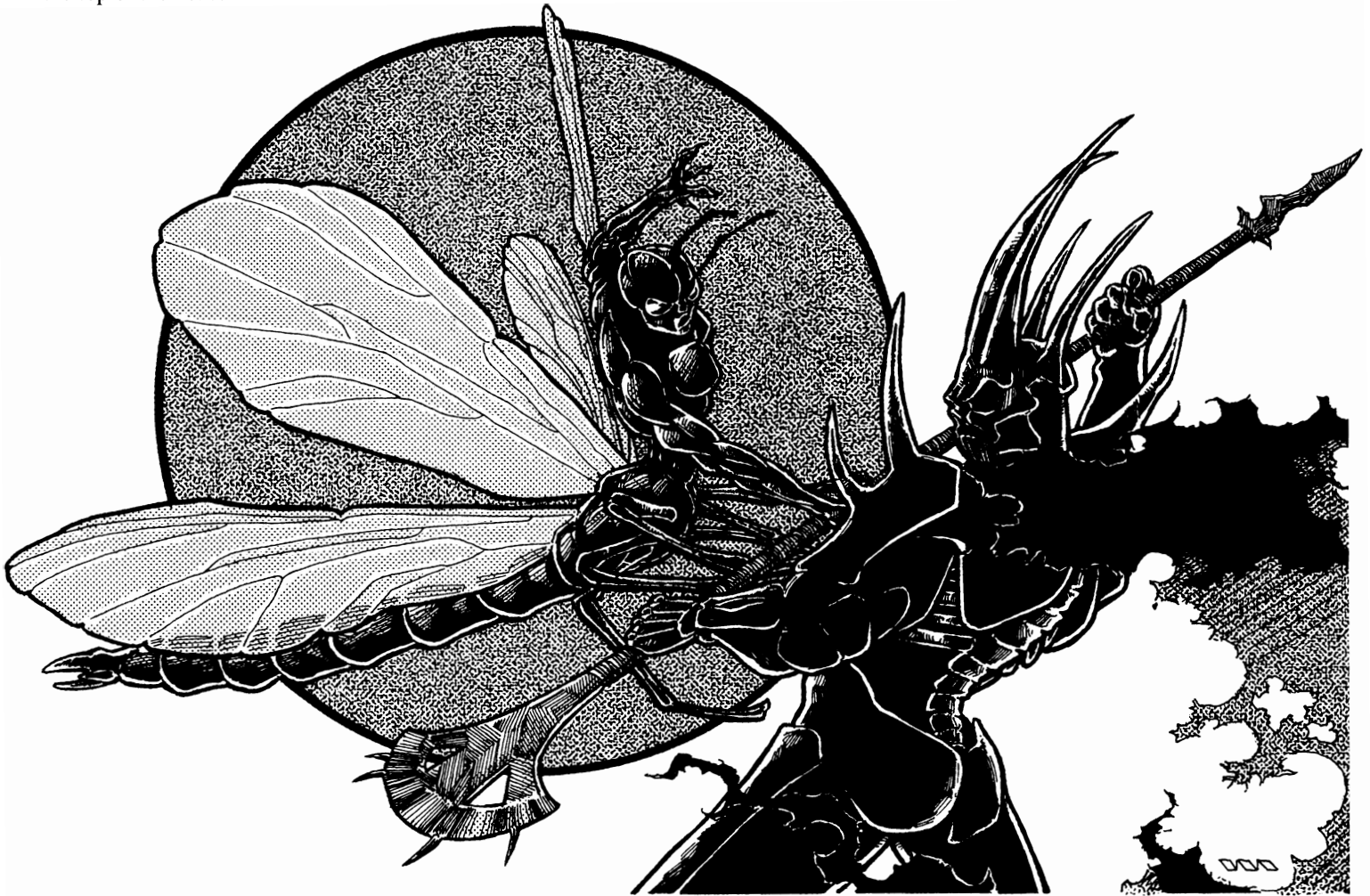

Insectoid Table

Insect-looking Nightbane became much more common after Dark Day than before. It is believed that the "new generation" of Nightbane feel alienated enough from the world that they subconsciously picked such alien shapes for themselves. Insect shapes range from the beautiful to the grotesque, but most are strange and intimidating. All insect Nightbane instinctively know how to swim at a base proficiency of 50%, have acrobatics at 50% and climb at 60% (unless stated otherwise), as well as +1 to roll with fall or impact.

As usual, the players select the insect species for his or character. If desired, Game Masters may modify the bonuses listed below to better represent the insect species picked by the player.

01-15% Giant Insect: The Nightbane becomes a giant insect at least six feet (1.8 m) in length (spiders and scorpions are not insects; ants, bees, wasps, flies, dragonflies, mosquitoes, beetles, preying mantis, butterflies, and moths are some common insect types). Most giant insect forms have at least one or two forms of attacks, be it pincers and bite or claws and stingers. Many can fly (with wings that lay on the back of the body like flies or protrude like butterflies) and others can run at great speeds.

Bonuses: +10 to P.S., +3 to P.P., +4 to P.E., and either +1D4×10 to running speed OR a flying speed of 2D4×10. +4D6×10 S.D.C. to hard body insects like ants and beetles, or 2D6×10 S.D.C. for soft body insects like flies and butterflies. The giant insect is +3 on initiative and +3 to all perception rolls. Add 1D6 to Horror Factor.

Claws add 1D6 S.D.C. to hand to hand damage, pincers 2D6, small insect mandibles 2D4 S.D.C. from bite attacks, medium 2D6 and large (like ants and beetles) 4D6 points of damage. Stingers like those of the wasp or bee inflict 2D6 damage from the stabbing attack and an additional 1D6 damage from poison, plus victims of the poison feel woozy and are -2 on initiative and -1 to strike, parry and dodge unless they successfully save vs non-lethal poison. The stinger does not fall off and the creature can sting repeatedly. The Nightbane will be unable to use tools or weapons or perform complex skills (-40% on skill performance that requires human hands and dexterity).

16-35% Were-Insect: A bipedal combination of human and insect, with two pair of clawed, spindly arms, hands and legs, vaguely humanoid shape, and insectoid head complete with antennae, pincer-like mandibles and multi-faceted eyes. Bonuses:

+6 to P.S., +3 to P.P., +3 to P.E., and either +5D6 to running speed OR a flying speed of 2D4×10. 3D6×10 to S.D.C. for hard body insects like ants and beetles, or 2D4×10 S.D.C. for soft body insects like flies and butterflies. Claws add 1D6 S.D.C. to hand to hand damage, and extra arms add one attack/action per melee round. Mouth mandibles inflict 3D6 points of damage. The insectoid is +2 on initiative and +3 to all perception rolls. Add 1D6 to Horror Factor.

36-55% Humanoid-Insectoid: The Nightbane's Morphus is basically human-like, with an extra pair of arms and a number of insectoid characteristics. The head is human, except for large, round, multi-faceted eyes and antennae. The skin is covered with a chitinous exoskeleton that provides 2D6×10 S.D.C. for hard body insects or 1D6×10 S.D.C. for soft body insects. The character may have insect wings, but otherwise has no other unusual limbs. Bonuses: +4 to P.S., +2 to P.P., +2 to P.E., and either +3D6 to running speed OR a flying speed of 1D4×10. Claws add 1D6 S.D.C. to hand to hand damage, and the pair of extra arms add one attack/action per melee round. The insectoid is +1 on initiative and +2 to all perception rolls. Add 1D4 to Horror Factor.

56-70% Insect Wings: The Nightbane has an otherwise normal body, except for the insect wings protruding from his back. Bonuses: 3D6 to S.D.C. and can fly with a speed of 1D4×10+20, and +1 to dodge when flying. Add 1 to Horror Factor.

71-80% Insect Head: An ordinary-looking human, except for the full insect head. Bonuses: 2D6 to S.D.C., +2 on initiative and +3 to all Perception rolls. The mandibles bite for 4D6 S.D.C. damage. Add 1D4 to Horror Factor.

81-90% Insect Eyes: The character has multi-faceted eyes. Bonuses: Polarized vision (work like sunglasses to reduce glare), can see in the ultraviolet and infrared spectrum of light and is +2 to all perception rolls. Unless the eyes are covered with sunglasses or mirror goggles, add +2 to Horror Factor.

91-00% Insectoid Centauroid: The Nightbane has the upper body of an insect-like humanoid with insect mandibles, eyes and antennae, and the lower body of a six-legged, giant insect; the insect body may also have wings. Bonuses: +6 to P.S., +2 to P.P., +2 to P.E., and +5D6 to running speed, plus 1D6×10 flying speed if it has wings. The insectoid is +1 on initiative and +3 to all perception rolls. Clawed hands add 1D6 S.D.C. to hand to hand damage, and mouth mandibles inflict 3D6 points of damage. Add 1D6 to Horror Factor.

Reptilian Table

Lizards of all kind are represented in the shapes of some Nightbane. It is possible that some of the legends of dragons may have originated from reptilian-shaped Nightbane. All reptilians instinctively know how to swim at a base proficiency of 45% and climb at 35%

01-20% Giant Reptile: The Nightbane has the shape of a giant lizard, typically over seven feet (2.1 m) tall, counting the tail (to determine the length of the Morphus, add 1D6 feet (0.3 to 1.8 m) to the character's Facade height). This giant form may be mistaken by onlookers as Komodo dragons, crocodiles and similar natural large reptilians. The reptile can move with great bursts of speed, but maximum speed cannot be maintained for more than 3D4 minutes. Bonuses: +3 to P.S., +4 to P.E. and +3

to P.P., +3D6×10 to S.D.C. and 4D6 to Speed. Its bite inflicts 4D6 S.D.C. damage and claws 2D6. +3 to Horror Factor.

21-40% Were-Reptile: A bipedal mixture of man and reptile, with the reptilian features predominating. The head is fully animal-like, and the arms and legs are underdeveloped but incredibly strong and tipped by razor sharp claws. Bonuses: +5 to P.S., +3 to P.E. and +2 to P.P., +2D6×10 to S.D.C., and 2D6 to Speed. Clawed hands and feet add 2D6 S.D.C. to hand to hand damage and +10% to climbing skill. The bite inflicts 3D6 damage. Add +1D4+1 to Horror Factor.



41-60% Humanoid-Reptilian: A human-shaped creature, scale-covered, but able to pass for a human if covered up in heavy clothing (i.e., a trench coat or a cape) or seen from a distance or in shadow. Bonuses: +3 to P.S., +2 to P.E. and P.P., 2D4×10 to S.D.C. and 1D6 to Spd. Clawed hands and feet add 2D4 S.D.C. to hand to hand damage and +5% to climbing skill. The bite inflicts 2D6 damage. Add 1D4 to Horror Factor.

61-80% Reptile's Head: A human body, except for the fully reptilian head. Bonuses: 2D6 to S.D.C. Bite inflicts 4D6 damage. Add 1D4 to Horror Factor.

81-00% Reptilian Centauroid: A huge creature that has the lower body of a reptile with four legs and tail, while the upper body is a scale-covered humanoid torso with a human-like head and features. This huge creature will be hard-pressed to fit into a vehicle or small room. Bonuses: +5 to P.S., +3 to P.E. and P.P., +3D6×10 to S.D.C. and 4D6 to Spd. Clawed hands and feet add 2D6 S.D.C. to hand to hand damage and the bite inflicts 3D6 damage. Add 1D6 to Horror Factor.

Rodent Table

This category includes all types of rats (the most common), mice, shrews, squirrels, chipmunks, rabbits, moles, and similar animals, whether or not they are actually true rodents, zoologically speaking. Rat-like Nightbane are very common in cities, and their shape often represents a will to survive at all costs, or a desire to hide in the shadows from the dangers of the world.

01-20% Full Rodent: The Nightbane's Morphus has the shape of a giant rat, roughly the size of a small bear or mountain lion. The creature is so large that nobody (not even New Yorkers) will confuse it for a normal animal. Bonuses: +2D6×10 to S.D.C., +4 to P.S. and +4 to P.P., +5 to P.E., +4D6 to Speed, is +10% to climb (if no climb skill is known the creature can instinctively climb at a base skill of 30%) and can leap 10 feet (3 m) high or lengthwise. The creature's acute senses add +1 to initiative and +3 to all perception rolls. Nightvision is 1000 feet (305 m). The giant rat can use tools or weapons but very poorly (-6 to strike or -30% on skill performance); they cannot punch or kick effectively, but can parry and slash with their claws: 1D6 damage from a claw strike, 3D6 S.D.C. from a bite and a body slam or jump kick does 2D6 damage. Add +1D4 to Horror Factor.

21-45% Were-Rat: A vaguely humanoid rat-creature, able to stand on two feet, with a long tail, fairly short arms, clawed hands, and a full rat's head. It is almost impossible to disguise the inhuman nature of the Nightbane, even with heavy clothing. Bonuses: +3 to P.S., +3 to P.P., +4 to P.E., +3D6 to Spd and 1D6×10 to S.D.C. Bite inflicts 3D6 S.D.C., and claws add 1D6 S.D.C. to hand to hand damage. The creature's acute senses add +1 on initiative and +2 to all perception rolls. Nightvision is 1000 feet (305 m). Add 1D6 to Horror Factor.

46-70% Humanoid Rodent: A fur-covered humanoid; the head is mostly human-like, but it tends to project forward more than normal, giving the Nightbane "weasel" or "rat" features. The creature has no tail and the fur is sparse enough near the face and hands to allow the character to pass for a normal human in bad light. Bonuses: +2 to P.S., +2 to P.P., +2 to P.E., +2D6 to Speed and +4D6 to S.D.C. Bite inflicts 2D6 S.D.C. and claws add 1D4 S.D.C. to hand to hand damage. Its senses add +1 to all perception rolls. Nightvision is 500 feet (152 m). Add +2 to Horror Factor.

71-90% Rodent Head: The Nightbane's body is a normal human, but the head is that of a giant rat or other rodent! Bite inflicts 2D6 S.D.C. The creature's acute senses add +1 to initiative and +2 to all perception rolls. Nightvision is 1000 feet (305 m). Add 1D4 to Horror Factor.

91-00% Rodent Centauroid: The Nightbane has the lower body of a giant rat, and the upper body of a humanoid. Add +4 to P.S., +5 to P.E., +2 to P.P., +4D6 to Speed, and 3D6×10 to S.D.C. Bite inflicts 3D6 S.D.C., and claws add 1D4 S.D.C. to hand to hand damage. The creature's acute senses adds +1 to initiative and +3 to all perception rolls. Nightvision is 500 feet (152 m). Add 1D4 to Horror Factor.

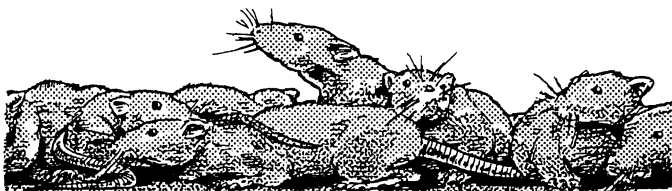

Snake Table

A traditional subject of fear and fascination, the snake is a common motif found among the Nightbane. Snakes are symbols of temptation, hunting, and subtlety. Cobra-based shapes are often found among Nightbane with leadership qualities or ambition. All snake Nightbane instinctively know how to swim at a base proficiency of 55% and climb at 40% (unless stated otherwise).

01-15% Full Snake Form: The character's Morphus has the shape of a giant snake (at least six feet/1.8 m in length; typically take the length of the Nightbane's Facade and add 1D6 feet/0.3 to 1.8 m to it). Bonuses: +6 to P.S., +3 to P.E., +2 to P.P. and +2D6×10 to S.D.C. The snake form has a base Climbing skill (60%, or add +20% to the character's current climbing skill, whichever is greater; applicable in Morphus form only). Add +5 to Horror Factor.

If the Morphus is that of a poisonous serpent (asp, cobra, rattlesnake, viper, etc.), its bite inflicts 2D6 S.D.C. plus venom does 6D6 damage (or 3D6 if a successful save versus lethal poison is made). Add another +1 to Horror Factor if poisonous.

A constrictor snake has all the base abilities of the *wrestling* skill, plus it can jab with its head or coil from its body to do the equivalent of punch damage. Crushing/constricting attacks do double the character's normal punch damage plus P.S. bonuses. Each act of constriction does damage and counts as one melee attack.

16-30% Limbed Snake: The Nightbane has a pair of scaly human-like arms, hands and legs stemming from a long snake-like body. The basic form remains that of a snake, with an over-long "neck" and a snake's head. The snake-man's "torso" can bend and twist with the full flexibility of a serpent and all limbs are double jointed and ambidextrous. Bonuses: Add one attack per melee round, +4 to P.S., +2 to P.E., +2 to P.P. and +2D4×10 to S.D.C. Add +15% to the Climbing skill if the character possesses it, otherwise base ability applies. Add 1D6 to Horror Factor.

If the Morphus is that of a poisonous serpent, its bite inflicts 2D6 S.D.C. plus venom does 4D6 damage (or 2D6 if a successful save versus lethal poison is made).

A constrictor snake has all the base abilities of the *wrestling* skill, plus it can jab with its head or coil from its body to do the equivalent of punch damage. Crushing/constricting attacks do double the character's normal punch damage plus P.S. bonuses. Each act of constriction does damage and counts as one melee attack.

31-50% Humanoid Snake: The character has the basic build and shape of a human being, but the skin is covered by colorful scales, the head and neck are those of a snake, and it has a long prehensile tail. In addition to the sharp fangs of a snake, the Nightbane also has sharp claws on his hands and feet that can inflict and additional 1D6 S.D.C. damage from punches/claw strikes and kicks. The bite inflicts 2D6 S.D.C., and if a poisonous variety, will inject a venom doing 3D6 damage (reduced to 1D6 on a successful save versus lethal poison). The tail can be used to hit, hold and carry objects or as an aid in climbing (add +10% to the climbing skill). Bonuses: Add one attack per melee round from prehensile tail, +3 to P.S., +2 to P.E., +1 to P.P., and +1D6×10 to S.D.C. Add 1D4+1 to Horror Factor.

51-70% Scaly Skin: A normal human body and features except for the scale-covered skin and eyes that are snake-like in appearance. Add 1D6×10 S.D.C. Add 1D4 to Horror Factor.

71-85% Half-Man, Half-Snake: A scale-covered human torso with arms and hands, a human head and a long snake-like body and tail. This Nightbane has no legs, and must crawl or climb using his/her lower body. The upper torso can bend and twist with the full flexibility of a serpent and all limbs are double jointed and ambidextrous. Bonuses: Add one attack per melee round, +4 to P.S., +2 to P.E., +3 to P.P. and +1D6×10 +10 to S.D.C. Add +20% to the climbing skill if the character possesses it.

If the Morphus is that of a poisonous serpent, its bite inflicts 2D6 S.D.C. plus venom does 4D6 damage (or 2D6 if a successful save versus lethal poison is made). Add 1D6 to Horror Factor.

A constrictor snake has all the base abilities of the *wrestling* skill, plus it can jab with its head or coil from its body to do the equivalent of punch damage. Crushing/constricting attacks do double the character's normal punch damage plus P.S. bonuses. Each act of constriction does damage and counts as one melee attack.

86-00% Snake's Head: The Nightbane has a normal human body, topped by a giant snake's head! Bite inflicts 3D6 S.D.C., plus if poisonous will do an additional 3D6 damage (1D6 if a successful save versus lethal poison is made). Add 2D6 to S.D.C., and 1D4 to Horror Factor.



Stigmata Table

Mockingly named after the "sacred wounds" said to appear on saintly people, stigmata are among the most disturbing deformities among the Nightbane. The common characteristic of all stigmata is that the Nightbane appears to be injured. The wound can be an open cut, blister, sore or a foreign object imbedded in the flesh. From time to time, the wound oozes with blood, puss, or other fluid. These wounds never heal, and are often a source of discomfort and pain to the character.

What do these marks represent? Are they an embodiment of the guilt, fears and psychic pain of the Nightbane? In times past, many religious people called Nightbane stigmata a sign of the devil and "the witches' mark." Modern thinkers believe them to be a reflection of psychological traumas. In a few cases, the stigmata are the result of terrible wounds suffered by the Nightbane just before his transformation. For example: 600 years ago when a young Nightbane first manifested his powers, he was under attack by soldiers. He had been stabbed and slashed repeatedly when the Becoming began, and as a result, his Morphus bore those wounds and they have never healed. Another example is *Burger-face* (see the **Campaign Section**), who first manifested when he was trapped in a burning building, and whose face has a horrible burned and mangled appearance.

Roll percentile dice to determine a stigmata.

01-05% Bloody Ooze: Covered in a slimy, blood-like liquid, making his skin slippery (add +2 to parry/dodge pins or grappling attacks). Add 1D4 to Horror Factor.

06-10% Corpse-Like: The Nightbane's skin is grayish-green, his eyes are sunken, and he looks like a days-old corpse, complete with the odor of death and signs of decay. Reduce P.B. by 25%, add 3D6 to S.D.C. and add 1D4 to Horror Factor.

11-15% Stitches: A crisscrossing of stitches at several points in the skin, gives the Nightbane the appearance of a "rebuilt" corpse. Sometimes, the limbs and body may not quite match. For example, the "sewn-on" limbs might belong to an animal, while the torso and head are human-like! This is particularly appropriate for lycanthrope Nightbane who bear stigmata. Add 3D6 to S.D.C. and 1D4 to Horror Factor.

16-23% Nails: Metal nails, pins, spikes or screws protrude from the character's skin. They can be localized to a few small areas on the body (around the eyes, on the forehead, hands, shoulders, torso, etc.), or they can completely cover the character (player's choice). Add 4D6 to S.D.C. and, if completely covered, a body slam inflicts 2D6 plus normal punch damage.

24-31% Razor Blades: Razor blades are unnaturally attached to the Nightbane. They may have replaced teeth or fingernails, or even cover the character like a porcupine's quills. Add 1D4+1 to H.F. The character gains +4D6 to S.D.C., and inflicts an additional 1D6 S.D.C. in hand to hand combat if the fingernails have been replaced with razors. Or a bite inflicts 2D6 S.D.C. if the razor blades appear in the mouth. If the blades are on the skin, body slams do 2D6 S.D.C. plus normal punch damage.

32-39% Broken Glass: Jagged pieces of glass are imbedded in the character's flesh. They can be located in small specific areas or cover the body. Same damage as razor blades above. Add 3D6 to S.D.C., and 1D4 to Horror Factor.

40-47% Barbed Wire/Razor Wire: Part of the character's limbs head, neck or torso are wrapped in barbed or razor wire, causing bloody wounds that never heal. Same damage as razor blades above. Add 4D6 to S.D.C. and 1D4 to horror factor.

48-55% Eternal Wounds: The Nightbane bears horrible wounds that never heal. Most often, the wounds are clearly visible and may appear to be deadly, including gaping chest wounds, gashes in the skull, cuts, gouges and other grotesqueries. The wounds cover any clothes the character wears with bloody patches in a matter of minutes, soaking through bandages and dressings after a while. Add 3D6 to S.D.C. and 1D4 to Horror Factor.

56-63% Missing Skin: Patches of skin or even the whole skin (player's choice) are missing, revealing bare muscle and bones. Add 3D6 to S.D.C. and 1D4+1 to Horror Factor.

64-71% Leatherboy/girl: Portions (or all) of the Nightbane's skin seems to have been replaced with shiny, polished leather, belts, bodysuits, and the like. S&M gear like hoods and straps are not uncommon, all grafted to the skin and flesh of the character. Metal studs, chains and other "decorations" finish the grotesque design. Add 5D6 to S.D.C. and 1D4 to Horror Factor.

72-79% Boils or Sores: Areas of the character's body are covered in open sores or festering boils. Add 3D6 to S.D.C. and 2 points to Horror Factor.

80-85% Zippers: Zippers close horrible wounds in the character's body. Add 3D6 to S.D.C., and 1 to Horror Factor. The Horror Factor is increased by 3 if the Nightbane opens the zipper to reveal the pulsing flesh or organs underneath!

86-90% Bones: Some (or even all) of the Nightbane's body has been stripped of flesh and muscle to reveal bare bone. Add 5D6×10 to S.D.C. and 1D4+1 to Horror Factor.

91-96% Biomechanical: Roll on the *Biomechanical Table*, but any modifications will appear to make bloody wounds or sores where the mechanics are attached or placed in the character! For example, if *Armorgraft* (see below) was rolled, the armor would appear to have been nailed or hammered into the flesh of the Nightbane, and its edges would have a patina of fresh blood! Add 1 point to the normal Horror Factor associated with that Biomechanical characteristic.

97-00% Combination of Two: Roll two times (ignore and re-roll any roll of 97% or higher) and combine the two characteristics and Horror Factor points.

Unusual Facial Features Table

Many Nightbane appear completely normal from a distance — until one looks them in the face.

01-07% Oversized Carnivorous Mouth: The Nightbane has supernaturally strong jaw muscles, enabling them to inflict 2D6 S.D.C. with a bite! Plus the character can hold on and continue biting (no attack roll is necessary, inflicts normal bite damage once at the beginning and once at the end of the round until dislodged or he lets go; no other combat actions are possible while using this attack). Add 1 to Horror Factor.

08-15% Glowing Eyes: The Nightbane's eyes glow with unnatural light, so bright that they can faintly illuminate a dark

area! Normal sunglasses will not be able to hide the glowing eyes, but mirror shades will. The Nightbane has enhanced nightvision (able to see in total darkness; range 2000 feet/610 m). Add 1 to Horror Factor.

16-22% Cyclops: The character only has one large eye in the middle of his forehead; perfect 20/20 vision. Add 2 to the Horror Factor.



23-30% Misshapen Facial Features: Some possibilities: The eyes are in the wrong place, the nose is flat or missing, the mouth is where the eyes should be and vice-versa, the creature has more than one mouth, and other bizarre features. Add 1D4 to Horror Factor.

31-38% Extra Eyes: The Nightbane has 1D4 additional eyes (roll or choose from 1-6 total eyes). They are arranged in two or three rows, and they can be human-sized or slightly smaller. Add +2 to perception rolls involving sight and +1D4 to Horror Factor.

39-46% Sharp teeth: The Nightbane has long fang-like teeth. The character's bite inflicts 3D6 damage. Add 2 to Horror Factor whenever the teeth are displayed (in a smile, for example).

47-55% Skull Face: The character's head is a fleshless skull (players may opt to let hair grow on the skull, or leave it bare). The skeletal head is sometimes surrounded by a nimbus of light or flames (1-30%), is completely fleshless and bare and grotesquely protrudes from a flesh neck (31-60%), looks more like a bony helmet or mask than a real head (61-90%), or has a different, unusual look (91-00%, the player may roll again for unusual facial features that further deform the skull, like small horns, and

additional eye sockets); roll or pick one. Add 2D4 to S.D.C., and 1D4 to Horror Factor.

56-62% Small Horns: The Nightbane has small, vestigial horns, typically similar to a goat's or a ram's. The horns can be disguised with a hat or other head covering. Head butt does 1D6 S.D.C. in addition to normal punch damage. Add 1 to Horror Factor.

63-70% Large Horns: Often similar to a ram's or deer's. The horns are so large that it is almost impossible to hide them. A head-butt inflicts 3D6 S.D.C. in addition to normal punch damage. Add 2 to Horror Factor.

71-78% Facial Tentacles: Writhing tentacles protrude from the face of the Nightbane! They can be situated anywhere in the the face; some examples include the chin for a "living beard" look, between the nose and mouth for a Lovecraftian appearance, or instead of hair for a Medusa-like look. Add 1D6 to S.D.C. and 1D4 to Horror Factor.

79-85% No Face!: The Nightbane has a perfectly smooth face; no eyes, mouth, or nose are visible. The creature can speak, but the voice seems to be coming from inside the smooth surface, and may have an inhuman quality, or simply sound muffled; player's choice. The lack of eyes does not impair the Nightbane's senses; it can see, smell and hear perfectly. To eat, food is seemingly pushed through the skin, like a soft membrane, where the mouth should be. Add 1D4 to Horror Factor.

86-90% Biomechanical: Roll on the *Biomechanical Table*, but only apply the results to the face/head of the Nightbane. The rest of the body may be normal or have completely different characteristics.

91-95% Alien Features: The Nightbane looks inhuman and alien. The head may be oversized with large (or small), black, almond shaped eyes, a tiny nose or nose holes, no facial hair, dark or pale complexion and other inhuman features (fangs, skin patterns, horns, etc.). Add 2 points to Horror Factor.

96-98% Two: Roll twice (ignore and reroll any result of 96% or higher) and try to combine the result. Some results might not make much sense at first, players are invited to use their imagination. For example: A player rolls for both Cyclops and No Face! In that case, the character has one central eye, and no other facial features. Or maybe he rolls Cyclops and Multiple Eyes instead; simply place one large eye in the middle, surrounded by smaller ones.

99-00% Three: As above, but roll three times.

Alien Shape Table

This category covers a wide variety of unusual shapes and forms that occasionally manifest in some Nightbane. Players are welcome to determine or guess what dark elements of their character's souls or subconscious are embodied in any of the alien forms listed below.

01-12% Plasmoid: The Nightbane's body has a semi-liquid consistency; he's made up of jelly-like blood! The basic shape of the character remains that of a bipedal humanoid (it can even have the exact outline of his Facade), but it can be changed at will, stretched, spread or even puddled into any shape the character wills. The character can squeeze through narrow openings

(even a couple of inches will do!), slip out of restraints and conceal himself as a glob or goo. Add 4D6 to S.D.C. and all physical attacks do half damage. Add 1D6 to Horror Factor.

13-24% Bark-like Skin: The character looks like a bizarre combination of a tree and human, with bark instead of skin, and often with leaves or vines instead of hair! Add 1D4×10 to S.D.C. and 1D4 to Horror Factor.

25-37% Bony Exoskeleton: The Nightbane is covered with bone-like plates or large scales, often with horn-like protrusions and short spikes. Add 1D6×10 to S.D.C. and 1D6 S.D.C. to all hand to hand damage. Add 1D4 to Horror Factor.

38-45% Thorns: Thorns protrude from the character's body! They may appear to be natural growths, or they might be stigma-ta-like, appearing to painfully pierce the character's skin! Add 4D6 to S.D.C. and 1D4 to Horror Factor.

46-54% Crystalline: The character looks predominately human, but has crystals that resemble quartz or diamonds growing out of his skin along the fingers, the bones of the hands, along the back of the arm, up and down the spine and at the elbow, shoulders and knees. The head can look completely human or the hair can be replaced with a cap of crystals or a crown of tall, jutting crystal. Add 2D4×10 to the S.D.C., heat and fire does half damage, and the character can parry bladed weapons and fiery torches with his bare hands. The fingernails are replaced by jagged crystal that slash doing 1D6 S.D.C. plus punch damage, and the crystal encrusted hands function similar to brass knuckles, adding 1D6 S.D.C. to punch damage. Furthermore, in bright light, the Nightbane glitters like a gem and may (1-60% chance) blind all who look at him from the reflected light. Add 2 points to Horror Factor.

55-66% Living Tattoos: The Nightbane's skin is covered with tattoos. Unlike normal body decorations, however, these tattoos change and move! The changes may reflect the character's current state of mind (i.e., an angry Nightbane might suddenly display violent or threatening tattoos) or might be controlled directly by the character (50-50 chance or select one). In the first case, the Nightbane has no control over the tattoos; they react to his emotions and may start squirming at any given moment. Add 1D6 to Horror Factor whenever someone notices the moving tattoos.

67-77% Unusual Skin Color: The Nightbane's skin has an inhuman hue. The color is too intense and sharp to be normal, body paint or dyes. Colors can include shades of yellows, reds, greens, blues, purple/violets, copper, gold, metallic grey, silver, pitch black, and stark white. Roll or pick one. Add 1 point to Horror Factor.

78-85% Hulking Monster: The character transforms into a huge, hulking brute with a large barrel chest, hunched back, long gorilla-like arms, and a comparatively tiny (human-sized) head. The face may be human, alien, animal, or monstrous in appearance. The misshapened hulk stands 1D6+6 feet tall (and that's with a hunched back), and weighs 80 pounds (36.3 kg) per every foot (0.3 m) of height! Bonuses: +1D6×10 to S.D.C., +1D4 to P.S., +2 to roll with fall or impact and add 1D4 to Horror Factor. However, reduce the character's speed by 10%.

86-95% Mouth-Covered Body! The Nightbane's body is covered by 2D6×10 tiny mouths! The mouths can make gestures, stick out their tongues, whistle, hoot, growl or even scream in a hellish chorus (adds 3 to Horror Factor when all of

them are screaming or screeching at once)! However, they cannot speak. The character can also grapple an enemy and let the tiny mouths bite him (this inflicts 1D4 damage per mouth; typically 1D6 mouths will bite at the same time). Add 1D4+2 to Horror Factor.

96-00% Combination of Two: Roll twice more (ignore and reroll any result of 96 or higher), and then combine the results.

Unnatural Limbs Table

01-10% Prehensile Tail: The Nightbane has a prehensile tail, which can be used to grasp and carry things or help climb. The tail is very strong, able to support the character's full body weight when suspended above the ground. However, it can only carry the equivalent of one-third of the character's body weight (typically about 60 lbs\27.2 kg). Add +20% to climb and balance when the tail is used and it adds one additional melee action/attack. Add 1 to Horror Factor.

11-20% Spiked Prehensile Tail: Same as above, except that the tail ends in a spike, blade, stinger or club with 2D4 small spikes at the end. Strikes with the tail inflict 2D6 damage.

21-30% Tentacles: The character has two tentacles in addition to his arms! These tentacles are very difficult to conceal (need at least a trench coat, cape or cloak). The limbs can grab and carry objects, but are unable to use firearms or other tools requiring fingers. A pair of tentacle strikes do 1D6 S.D.C. in addition to normal hand to hand damage, and provide one additional attack/action per melee round. Add 1D4 to Horror Factor.

31-40% Long, Sensitive Fingers: The fingers on the hands are three times longer than normal. They are delicate and sensitive, providing a bonus of +5% to each of the following skills or skill categories: Medical (all), demolitions (both), electronics (all), computers (all), pick locks, pick pockets, and climbing.

41-50% 2D4 Pairs of Tiny Arms and Hands: The character has several tiny arms about one-third the size of a normal arm, usually located along the length of his forearm(s) or clustered at the shoulder(s). Each has a P.S. of only 1D6 and inflicts only one point of damage in combat (and then only if a foe gets close enough). However, they can grab and carry small and or light objects or wield razor blades, small knives, or ice picks (1D4 damage each). Add 1D4 to Horror Factor.

51-65% Four Arms: The Nightbane has an extra pair of arms and hands. Adds one attack/action per melee round, and all are ambidextrous and double jointed. Add 1D4 to Horror Factor.

66-80% Pseudopods: At will, the Nightbane can extract 1D4+1 tentacle-like limbs from his flesh, much like an amoeba can extend pseudopods. The process of extending these limbs is utterly horrible to a human being, because these fleshy limbs break through the skin as if an unwholesome parasite were climbing out of the character's body! Treat the pseudopods as tentacles (see above), add one melee attack for each *pair* and each limb has 22 S.D.C. Add 1D4+2 to Horror Factor whenever the pseudopods are extended.

81-90% Articulated Spikes: The character has four spikes or spines that resembles the spine or legs of an insect. Each is about the size of a survival knife, but can extend to twice that length in an instant. They are distributed along the side of each forearm



(two on each arm) or on the chest, or sides of the body. These slim, chitinous limbs end in sharp points, and can move independent of each other like tiny, stiff arms and even rotate in a 360 degree circle. They are used to parry an enemy's hand to hand attacks (+2 to parry) and to stab or slash opponents who come within arm's length. The four spikes add one attack per melee round and each inflicts 2D6 S.D.C. damage, but they cannot grab or manipulate objects. Add 1D4 to Horror Factor.

91-00% Antenna: A pair of antennae are located on the character's head. Each can move like an arm, independent from each other, and can dodge attacks (+3 to dodge; each has 15 S.D.C., and will regenerate within 72 hours). They can look like any variety of insect or crustacean antennae and are typically, thin, whip-like limbs that extend 1D4 feet (0.3-1.2 m) in length. These sensitive "feelers" enable the Nightbane to move around in total darkness, can measure and detect changes in the air temperature and humidity (automatic), wind movement and direction (automatic), detect and identify common odors (66% proficiency), track by smell (50%), and sense an approaching rainstorm (70%; storm will arrive within 2D6×10 minutes). Adds 1 point to Horror Factor.

Biomechanical Table

Many occultists point to the existence of biomechanical Nightbane as proof that the Morpheus is some sort of physical manifestation that reflects the Nightbane's personality. How else could these unnatural and artificial looking components be part of the creature? Even before complex machines appeared, the earlier biomechanical Morphi had limbs shaped like swords, metal gauntlets, and other weapons and gizmos. In the times of the Industrial Revolution, some Nightbane who were reported to have steam-powered, piston-driven limbs and riveted-metal skins, appeared for the first time. In the last years of the 20th Century, "cyborgs" became fairly common. Biomechanicals seem to embody the fascination and love or abhorrence and fear the character has toward machines or science.

Despite their artificial appearance, biomechanical characteristics are as much a part of the Nightbane's living body as "natural" skin and bones. The biomechanical components do not have any of the limitations of true cybernetic prosthetics, and heal at the same rate as the Nightbane does.

01-10% Armorgraft: Pieces of archaic body armor (helmets, breastplates, gauntlets, chain mail, segmented mail) are fused with the Nightbane's skin. Add 1D6×10 to S.D.C. and 2 to Horror Factor.

11-20% Plastic: Parts or all of the character's skin have been replaced with plastic or rubber (player can pick the colors and texture). Add 5D6 to S.D.C. and 1 point to Horror Factor, unless, the skin coverings are made up of transparent plastic, revealing internal organs, in which case H.F. is 1D6.

21-25%: Rocket Jets: The Nightbane has metallic exhaust tubes and small jet engines growing out of his back! They provide limited flight: 80 mph (128 km), maximum altitude 5,000 feet (1524 m) and hover capabilities. There is actually a roaring sound of engines when the jets are used, so prowl is impossible even when hovering. Add 4D6 to S.D.C. and 1 point to Horror Factor.

26-30% Metal Teeth and Talons: The Nightbane has metal fangs and talons instead of normal teeth and fingernails (may be retractable). The metal teeth inflict 3D6 points of damage with a bite, and the claws add 1D6 S.D.C. to hand to hand damage. Add 2 to Horror Factor.

31-40% Metal Endoskeleton: Metallic bones are mixed with living flesh in grotesque ways. There is always a place where the metal seems to rip out of the skin, usually on the hands, arms, neck, cheeks and legs. Add 1D6 to H.F., +2 to P.S., +2 to P.E., and +2D4×10 to S.D.C.

41-50% Mechanical Limbs: The arms and legs of the Nightbane are obviously mechanical. They may be piston-driven, huge mechanisms of iron and bronze, or microchip covered or chrome-plated creations of the "cyberpunk" mythology. These limbs do not bleed when struck, instead a sort of oil or grease may ooze out or wires, metal components and other artificial "guts" are revealed. Add +4 to P.S., +1D4×10 to S.D.C. and (if the legs are also mechanical) +4D6 to Speed. Horror Factor is increased by 1D4.

51-60% Weapon Hand: One or both of the Nightbane's hands can metamorphosize, at will, into a hand to hand weapon such as a knife, a sword, battle axe, trident, sickle, etc. The weapon does normal damage for that particular weapon type, in addition to P.S. damage bonuses, and there is no risk of it breaking (see **Supernatural Strength Damage**). In addition, the character is +1 to strike and parry with his weapon limb and add 2 to Horror Factor.

61-70% Metal Exoskeleton: The character is covered in mechanical armor that can look hard and bulky with rivets and seams, or smooth and chrome-like — Victorian-era Nightbane often walked the world with riveted iron instead of skin. Modern characters tend to "favor" metallic bands or a combination of metal plates and bands, and resemble robots or suits of power armor. Add 3D6×10 to S.D.C., +2 to P.S., and +1 to P.E. Add 1D4 to Horror Factor.

71-80% Metal Head & Camera Eyes: The character's head looks like a robot or cyborg and instead of eyes, he has two camera lenses protruding from the eye sockets. These artificial eyes raise the character's Nightvision range to 2000 feet (610 m) and provides him with telescopic sight like a pair of high-powered binoculars, and polarized filters. Even more amazing, the Nightbane can turn his eyes into movie projectors, and show moving pictures of anything he remembers (the depiction will be literally as seen by his eyes and may reflect personal prejudices, bias, and emotions)! These two-dimensional projections have no sound, but are otherwise picture-perfect. Add 1D4 to Horror Factor.

81-90% Wheels or Treads: Instead of legs, the Nightbane is a two-wheeled man-machine hybrid. The upper body looks human or half human and half cyborg, while the lower body is a machine vehicle. The vehicle part of the body can look like a motorcycle, four-wheeled vehicle or miniature tank with treads. More than one motorcycle enthusiast has found himself grafted to a Harley Davidson, and gun-bunnies or military aficionados to the chassis of a tank! Add 2D4×10 to Speed, +3 to P.S., +2 to P.E., and 3D6×10 to S.D.C. The Nightbane may find it difficult to operate indoors or in confined spaces. Add 1D4 to Horror Factor.

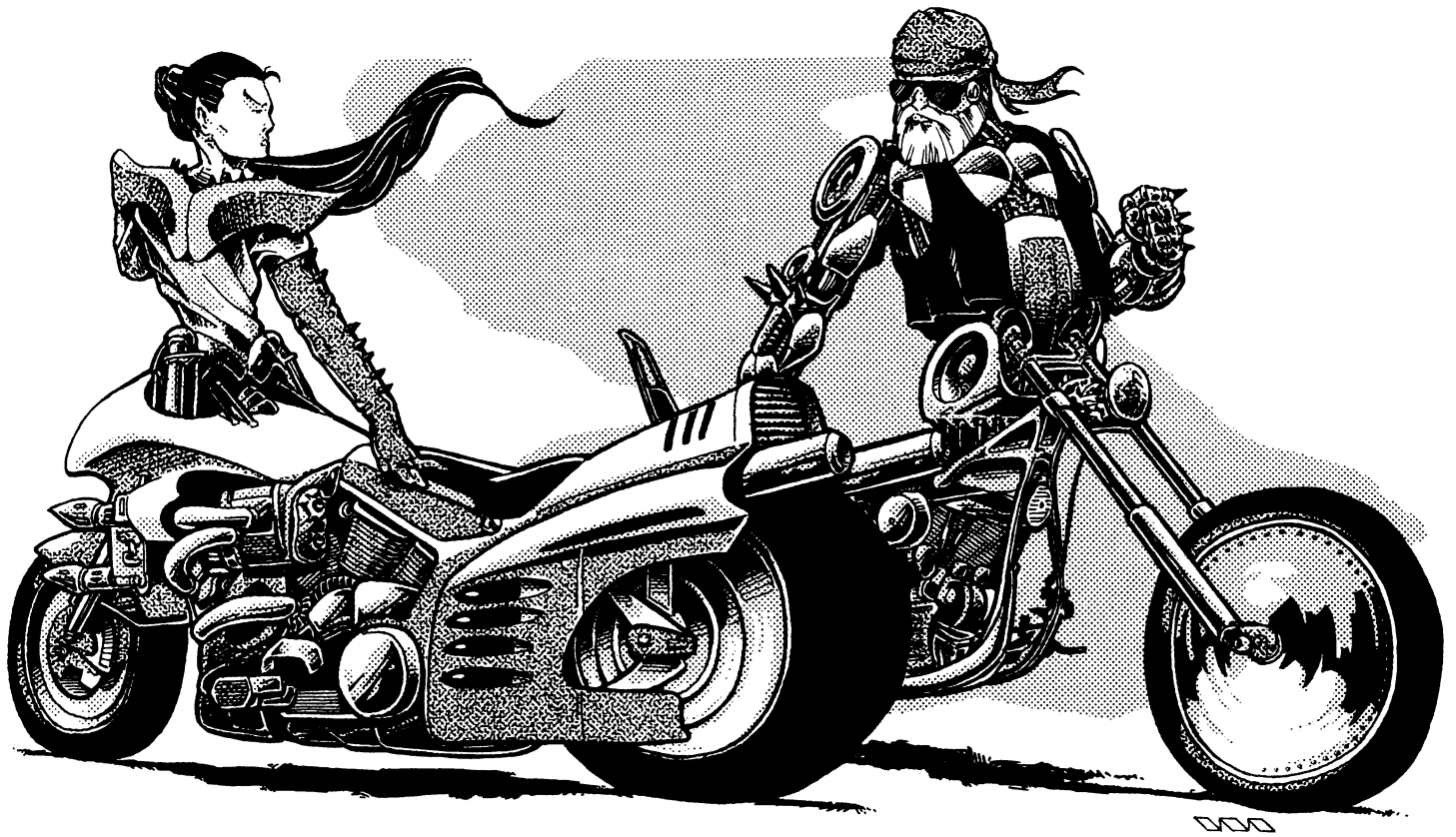

91-00% Gun Limbs: The Nightbane has one or more guns built into his body! The grotesque result is usually a weapon barrel protruding from flesh and muscle. These guns will have normal gun stats; the biggest gun available would be a rifle type doing 6D6 S.D.C. damage. **Note:** This advantage actually requires a permanent P.P.E. sacrifice, equal to 1 P.P.E. per die of damage, and 2 P.P.E. if the gun is an automatic weapon (capable of firing bursts). Additionally, the character has to find bullets for the gun! A maximum of 100 bullets can be “stored” inside the body (to do this, the Nightbane literally has to shove the bullets into his flesh, inflicting 1D6 S.D.C. to himself per 10 bullets). Add 1D4 to Horror Factor.

Nightbane[®] Talents

Talents are supernatural powers, somewhat similar to magic spells, instinctively known to Nightbane; they cannot be taught or learned. Talents typically appear for the first time at the first Becoming. Later on, additional Talents are acquired when the Nightbane focuses his mind intensely and wishes for them! Often, a Nightbane sees a Talent being used by someone else and will decide to try to develop it for himself. This is a mystical process in which the Nightbane uses his force of will and link to the supernatural to learn a new way to reshape his body’s mystic energies or view of reality. The process is arduous and painful, often requiring a sacrifice of a portion of the Nightbane’s life force!

There are two types of Talents. “Common” Talents are available to all Nightbane and are the most widely found among these supernatural creatures. Then there are “Elite” Talents, powers that are restricted to a few types of Nightbane. For the most part, Elite Talents are intimately related to the Nightbane’s Morpheus and his basic nature. Animal-like Nightbane for instance, often evidence powers to control and manipulate animals, while Biomechanical-oriented ones have powerful affinities toward machines.

P.P.E. and Talents

P.P.E. is short for Potential Psychic Energy, an invisible force that exists in every living being (see the **Magic Section** for more information on P.P.E.). Nightbane have an immense reservoir of P.P.E., and they use this energy to power their Talents. P.P.E. is used by Nightbane in two ways: 1. The Becoming, in which P.P.E. is permanently expended in the process of transforming the Nightbane. 2. To “fuel” the use of Talents, or by being “burned off” to permanently give the Nightbane the ability to use a new Talent.

Acquiring Talents

At first level, the Nightbane gains one Talent for free and one additional *free* ability at levels four, seven, ten and twelve. *Free* means it does not cost the character any of his P.P.E. base to acquire the Talent.

At level one and upon reaching each subsequent new level of experience, the Nightbane can purchase two additional Talents, but, each purchase will cost the character a *permanent* expenditure of P.P.E.! There is no limit as to how many Talents can be purchased. However, before players decide to go hog-wild and spend all their character’s P.P.E. on magic Talents, they should keep in mind that using those powers also requires a temporary

P.P.E. expenditure, similar to casting a spell. A Nightbane with seven Talents and only 10 to 20 P.P.E. will not be able to make much use of them, while a character with only three Talents and 100 P.P.E. will have a great deal of power and flexibility.

Some Talents require a degree of control and sophistication unreachable by younger and less experienced Nightbane. These powers are not available at the lower levels of experience, and must be acquired later in the course of a campaign. Those powers have their level requirements noted in the Limitations entry.

Note: Each Talent description will indicate the permanent P.P.E. cost to *acquire* a Talent, as well as the cost to use it again, like casting a magic spell. Remember, unlike a magic *spell* or ritual, Talents are an innate ability and cannot be taught or learned, they must be *desired*. Once a Talent is acquired, it is acquired for life and cannot be traded or exchanged for a different one; another reason to make selections carefully and with thought.

Using Talents

Using Talents requires a short period of concentration (usually a few seconds, equivalent to one melee attack/action), followed by the expenditure of P.P.E. This is why a character needs to keep a healthy reserve of psychic energy.

Some powers work only once and must be reactivated every time they need to be used. Others last for a period of time (from minutes to hours); at the end of that period, more P.P.E. must be spent to maintain the Talent's effect or it ends.

Different Nightbane manifest the same Talents in different ways, depending on their inherent nature. The manifestation of the Talent is left to the player to depict. For example, the **Darkwhip**, a tendril of black energy, might appear as a tentacle coming from an animalistic Nightbane; an arc of crackling black energy in the hands of a biomechanical; or even a black tongue coming from the mouth of a more inhuman-looking character. At the Game Master's discretion, the way the Talents manifest may temporarily increase the Nightbane's Horror Factor by a point or two, or even have their own Horror Factor.

Many Talents cannot be combined. Generally speaking, any Talent that transforms or alters the character prevents the character from using any other Talents for the duration of the power. Protective Talents can typically be used in conjunction with others, except where otherwise indicated. Other limitations may apply. For instance, the vast majority of Talents can only be used in the Morphus form.

Some abilities can be resisted by the target/victim. Typically, a save versus magic is required to successfully resist a Nightbane Talent.

Creating New Talents

Nightbane Talents are said to be limited only by the imagination and willpower of each person. The list below is far from exhaustive and new Talents will appear in future **Nightbane** sourcebooks. At the Game Master's discretion, he or his players may create new powers or use abilities found in other Palladium supplements like **Heroes Unlimited**, **Rifts**, **Mystic China**, and **Ninjas and Superspies**. The Game Master is the final arbiter as to what abilities are appropriate for his/her campaign. Remember, Nightbane is a dark fantasy/horror campaign, NOT a super-

hero game. Powers and abilities that would unbalance or detract from the atmosphere of the campaign should not be allowed. This will change from campaign to campaign or with personal taste and preferences, of course. When designing a new Talent, the P.P.E. expenditures (both for activation and permanent) should be balanced with the ones below. Typically, a minor ability will cost 2-5 P.P.E., while the most powerful ones might cost as much as 20-30 P.P.E. (permanent and to activate).

Alphabetical Nightbane Talents List

Anti-Arcane
Borrow Morphus
Darksong
Darkwhip
Doorway
Infectious Control
Lightning Rider
Mirror Search
Mirror Sight
Nightbringer
Premonition
Reshape Facade
See Truth
Shadow Blast
Shadow Shield
Shadow Slide
Sharing the Flesh
Shroud
Soul Shield
Splittin' Image
Storm Maker

Elite Nightbane Talents

Bloodbath
Deus Ex Machina (Machine Control)
Lord/Lady of the Wild (Animal Control)
Swarm Self

Common Nightbane® Talents

Anti-Arcane

When activating this Talent, the Nightbane is surrounded by an aura of black light (easily confused with the Shadow Shield described below). While this aura is in effect, the Nightbane is utterly invulnerable to the effects of magic! Any magical spell that can be resisted by a save against magic will have *no effect* on the character. Spells that must be dodged, or have no saving throw, will work normally. The Anti-Arcane will last one minute (4 melees), at which time it must be reactivated.

Limitations: Usable only by the Morphus. Not available until the character has reached fifth level.

Cost: 15 P.P.E. are permanently spent to acquire it and 20 are needed every time to activate it.

Borrow Morphus

This rare power allows a Nightbane to assume the Morphus of another of his kind! The “other” Nightbane whose likeness is being copied suffers no ill effect other than the shock of seeing his double. The character gains the shape, all physical attributes, S.D.C. and hit points of the “borrowed” shape. He can also use any of the Talents possessed by the Nightbane he is imitating, but only abilities that the borrowing character knew the other possessed. Furthermore, the borrowing Nightbane cannot use his own Talents until he resumes his true form. He also uses his own combat skills (modified by the borrowed form’s attribute bonuses) and his normal skills — the Talent borrows only the other person’s physical body and does NOT include the character’s memories, knowledge, or insanities. The transformation lasts 4 melee rounds (one minute).

Limitations: Usable by the Morphus only. Not available until fifth level.

Cost: 15 P.P.E. permanent; 15 to activate, plus 15 P.P.E. for each additional minute the borrowed Morphus is kept.

Darksong

The Nightbane can emit a piercing, deafening sound; it can be an inhuman howl, a mighty roar, an ultrasonic keening, or even electronic feedback, depending on the Nightbane’s Morphus. Targets must make a roll to save (P.E. bonuses apply); if they roll under a 10, they are stunned for 1D4 melee rounds. The attacker can raise the number needed to save by expending additional P.P.E.: +1 point per 3 P.P.E. The Darksong can be used against an area (60 feet/18.3 m radius); in that case, everyone in the area, friend or foe, must make a save, but they are at +4 to resist.

Limitations: Usable by the Morphus only.

Cost: 7 P.P.E. are permanently spent to acquire it; 5 P.P.E. are needed to activate it (+3 to raise the save number by +1).

Doorway

Creates a door of dark energy that leads to a specific location desired by the creator of it. Takes one melee round (15 seconds) of concentration. Range: To a location up to 1 mile (1.6 km) per 2 P.P.E. spent. The Nightbane must have been to the destination point at least once in his life, or he must have line of sight.

Limitations: Usable by the Morphus only. Not available until reaching 5th level.

Cost: 15 P.P.E. to permanently acquire it, and a minimum of 2 P.P.E. to activate (see above). This power can also open a doorway to the Nightlands or back, but this costs 40 P.P.E., plus 5 P.P.E. per mile (1.6 km).

Darkwhip

Creates tendrils of darkness that inflict *supernatural damage* with a P.S. equal to the amount of P.P.E. spent on creating them. Lasts for 4 melee rounds (one minute), after which they must be recreated. Range is 60 feet (18.3 m). The tendrils can have any shape, not limited to whips and tentacles, although those are the most common. The Darkwhip can be used to strike and also to entangle or disarm, provided those skills are known to the wielder.



Limitations: Usable by the Morphus only.

Cost: 8 permanent to acquire; 4 to activate (additional P.P.E. increases the amount of damage the whip inflicts with each strike).

Infectious Control

This often repulsive Talent allows the Nightbane to take over a person by “infecting” him with a portion of his body. The manifestations of this power are varied. Some Nightbane shoot spines or needles that pierce the flesh of the target, allowing them to take over. Others create little “parasites” that burrow into the victim’s body. Biomechanicals often drill or shoot wires or microchips into the victim. Some Stigmata sufferers actually force-feed the victim some of their blood to infect them. Once the infection is complete (usually takes one melee round from the time the piece of the Nightbane has entered the body of the victim), the subject is controlled by the Nightbane for one melee round (15 seconds). At the end of the round, the victim can try to resist (save vs magic); if he fails the save, he is under the control of the Nightbane for 30 minutes. New saves are allowed every 10 minutes.

While in control, the Nightbane can see, hear and experience everything his victim does while he acts as a puppeteer, controlling every word and movement of the victim. The main drawback is that the Nightbane has to split his concentration and attention between his own body and that of his victim. Thus, his attacks/actions per melee round are divided evenly between the

two bodies. He has no initiative bonus, and combat bonuses and skill performance is reduced by half, unless he relinquishes his control over his puppet.

The “infection” also allows the Nightbane to search the memories of his victim; one piece of information can be extracted by spending an additional 5 P.P.E. (and the victim gets a separate save to resist against the intrusion; this save is against psionic attack rather than magic). Each “memory search” takes 1D6 minutes and is limited to one small bit of information at a time.

Limitations: Usable only in Morphus form and is not available until 6th level.

Cost: 20 P.P.E. are permanently spent to acquire it; 20 P.P.E. to activate, plus 20 P.P.E. every additional half hour. The memory of the victim can be searched for an additional 5 P.P.E. per piece of information.

Note: Victims who have an M.E. of 7 or less are controlled for an hour at a time rather than the usual half an hour.

Lightning Rider

The Nightbane becomes a being of pure electrical energy! Unless a great deal of P.P.E. is spent, the electrical charge is weak and does not inflict damage. However, while in electrical form, the Nightbane can travel through conductive materials at enormous speeds. When the power is activated, the Nightbane disappears in a flash of electricity and “leaps” onto the nearest conductive material (metal and exposed wires works best). If no such material is around, the Nightbane appears to become a small pool of sparks, or a small crackling lightning ball that crawls around at a speed of 8.

With the invention of the telephone and electrical wires, this Talent came into its own and enables Nightbane to travel from one corner of the world to the next in a matter of minutes through them. Some Nightbane become extremely proficient in navigating through telephone exchanges. The easiest way, of

course, was to call the place one wished to travel to and then travel through the phone lines and jump out of the receiver! With the advent of computers and the Internet, this power has become even more influential. A character with Computer Operations can understand the information superhighway and hitch rides on modem calls. A character with Computer Programming can become the ultimate hacker!

Limitations: Usable by the Morphus only.

Cost: 15 P.P.E. to permanently acquire it; 10 to activate per minute (it takes one melee round of concentration to activate). The Nightbane can increase the voltage to inflict damage: 1D6 S.D.C. per 5 P.P.E., per each attack; 8 points of damage will fry most electronics like radios, computers, etc. Tempest-hardened systems will survive as much as 40 S.D.C. points before being disabled.

Mirror Sight

This and other mirror related talents and natural abilities give the archaic name of “looking glass” great new significance when dealing with the Nightbane and the Nightlords. This Talent enables the Nightbane to see the other side of a mirror, into the Nightlands, and vice versa, as if it were a window. A mirror or any highly reflective surface (glass, polished metal, a quiet body of water) must be available. The character can only see what the mirror image faces in the Nightlands, and vice versa. Some Nightlands creatures may sense they are being “looked at” and could cross over to confront or attack the “peeper” (see the **Nightlands Section** for more information).

Limitations: Requires a mirror; can be used by both Morphus and Facade. Duration is limited to 10 minutes per level of the character’s experience.

Cost: 5 P.P.E. for permanent acquisition; 2 to activate.

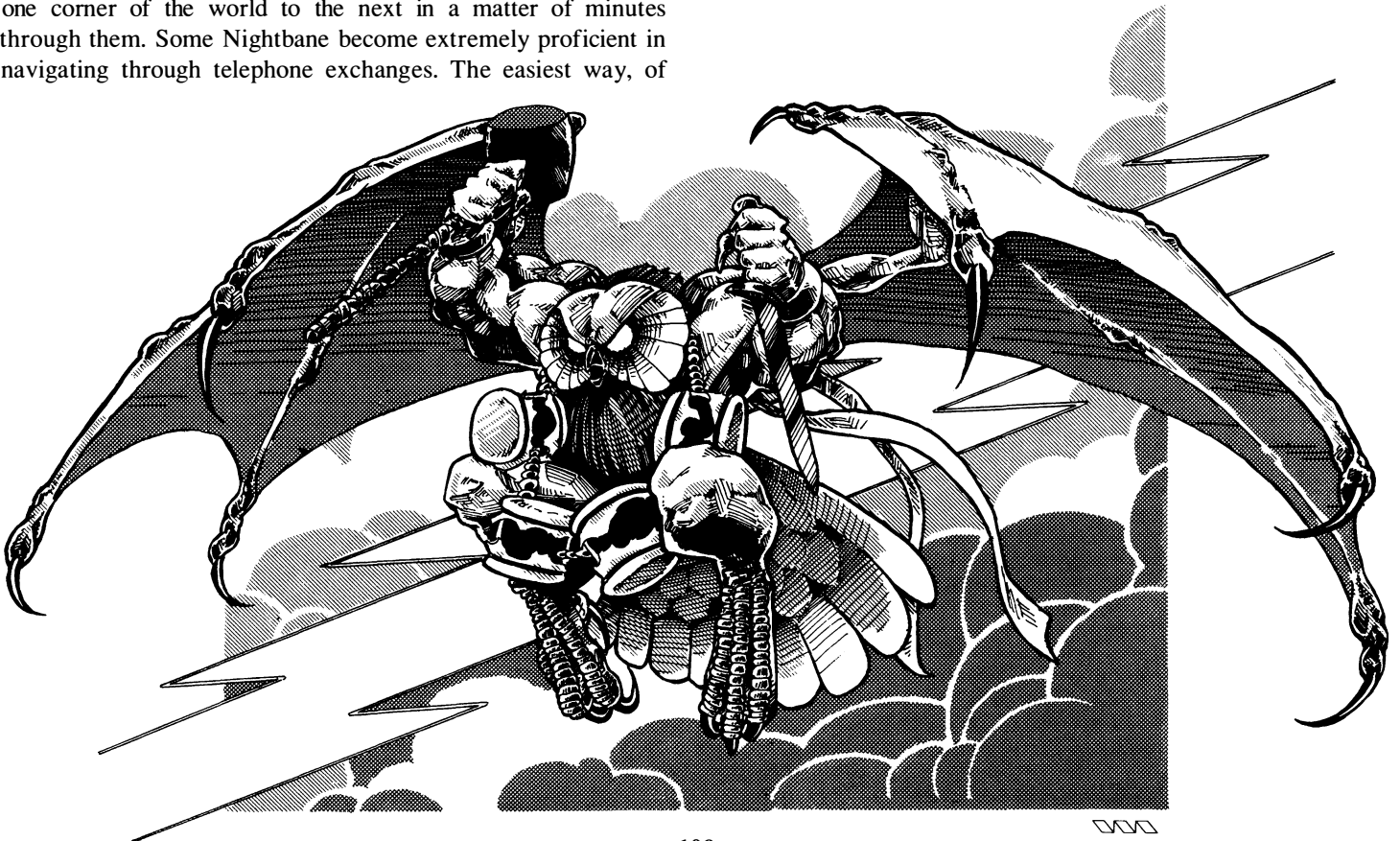

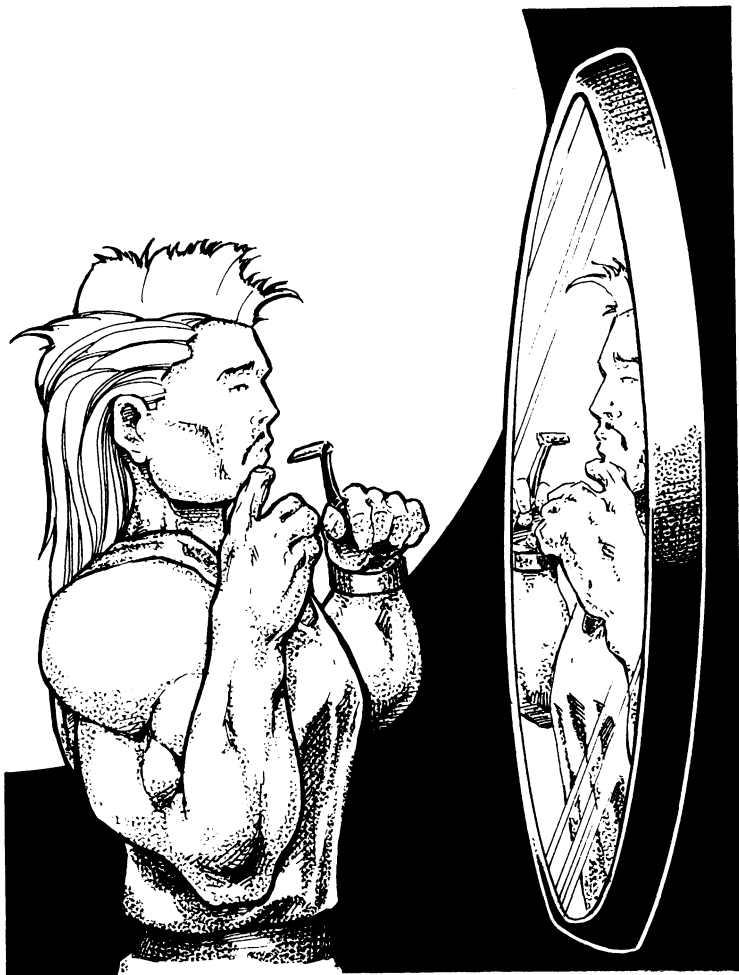

Mirror Search

Prerequisite: Mirror sight

The Nightbane is able to see through the mirror closest to the person or object he seeks. This is an area effect Talent that effectively scans a 10 mile radius (more if additional P.P.E. are expended) in search of the person or item sought. This does not mean that the nearest mirror will reveal the target of the search, but the closest area and mirror to it. For example: Searching for a kidnapped friend, the mirror search may reveal the image of a bathroom in a hotel. The name of the hotel is visible from the hanging towels, which may be enough to figure out, at least roughly, where the person is. Or there may actually be a mirror in the hotel room (there usually is) that shows the Nightbane's friend bound to a chair and being interrogated by two thugs and a Hound.

Limitations: Usable only by the Morphus.

Cost: 10 P.P.E. to acquire permanently; 15 to activate for a 10 mile area, +5 P.P.E. per additional 10 miles (16 km).

Note: Both mirror sight and mirror search show only images, not sound — it's like looking through the glass of a closed window into the room or area where the mirror is located (which may show parts of other rooms or a hallway, things outside the windows in that room, etc.).

Covering a mirror with a blanket, towel, or other covering will prevent a character from effectively using mirror sight and mirror search, because all the mirror will show is that it is covered. However, it does not prevent a Nightlord or other so empowered

being from traveling and entering that room through the covered mirror, even if wrapped snugly — the monster tears right through the cloth or tarp. However, painting the mirror will prevent such passage as well as the use of the mirror as a window.

Nightbringer

Absorbs light around the Nightbane, creating an area of darkness equal to 10 feet (3.0 m) in diameter per every 2 P.P.E. spent. The power also absorbs energy attacks, except Shadow Blast, Darkwhip and other darkness-based attacks and magic. People caught in the unnatural darkness are at -6 to strike, parry and dodge, and -4 on their perception rolls (penalties are half for creatures with nightvision).

Limitations: Usable by the Morphus only.

Cost: 5 P.P.E. to acquire permanently; 2 minimum to activate. Each additional 2 P.P.E. increases the diameter of the darkness by 10 feet (3 m).

Premonition

Gives the character feelings and visions about the future, often at unexpected times (ultimately, when the Game Master decides the character should get a vision, he does) or at moments of crisis. For the most part, a premonition will give the character a feeling that something good, bad or dangerous is going to happen soon, or at some particular place, or to some particular person. These feelings are just that, and do not come with any dreams or images.

“Visions” on the other hand, are usually images and/or short dream sequences that are accompanied by “feelings.” These images are often symbolic omens and can be cryptic (but G.M.s, not too cryptic) and may give some hints of things to come. For example: The Nightbane may have a reoccurring vision about a man or Nightlord, or minion slaughtering innocent people, his friends or even himself. The murderous figure is always in shadow so his features cannot be seen, but the vision always ends with the image of a stylized eagle. Then one day, the Nightbane meets a person with a tattoo of that eagle, indicating that this person is the culprit, but not always. The tattoo could be the symbol of a gang or cult worn by all its members in one fashion or another. Or it could be the logo for a corporation, or the emblem for a special police squad, the hilt of a magic sword, a statue, the cover of a book, and so on. At any rate, it gives our hero some warning about danger and who or what might be involved.

Limitations: Usable by the Morphus only. A premonition can happen spontaneously, or when the Nightbane actively attempts to sense the future.

Cost: 2 P.P.E. to acquire it permanently; 2 to activate and 2 when a spontaneous occurrence happens.

Reshape Facade

Although contemptuously called the Facade, the Nightbane's human form is as unique and real to him or her as the superhuman Morphus. Nightbane with this Talent can *temporarily* alter the shape of the Facade, changing the features, hair color and even the size of their human form. The more extensive the change, the more P.P.E. the transformation will cost. Imitating a

particular person is possible, but very difficult to get right (20% plus I.Q. bonus, plus 3% per level of experience).

Limitations: Usable by the Facade only. Not available until the 3rd level.

Cost: 12 P.P.E. to acquire it permanently, 6 to activate plus 4 per additional hour the disguise is desired.

See Truth

Every time this power is activated, the Nightbane will be able to see the true nature of one person or object. In the case of Nightbane, the character will be able to see the target's true Facade and Morphus forms, superimposed on one another. The alignment of the target can also be seen by the character; applicable to humans and Nightbane (in the latter case, counts as a separate use of this Talent). Furthermore, it will reveal strong magic emanations, the undead/vampires, serious illness, and strong emotions (hatred when the person is smiling and being nice, etc.); all considered aspects of the soul and/or personality of the target.

The subject saves against magic (12 or higher) to resist revealing the truth. The Nightbane can increase the difficulty of the save by expending more P.P.E.: every additional 4 P.P.E. raises the save number by +1 (maximum of 18, for 24 P.P.E.).

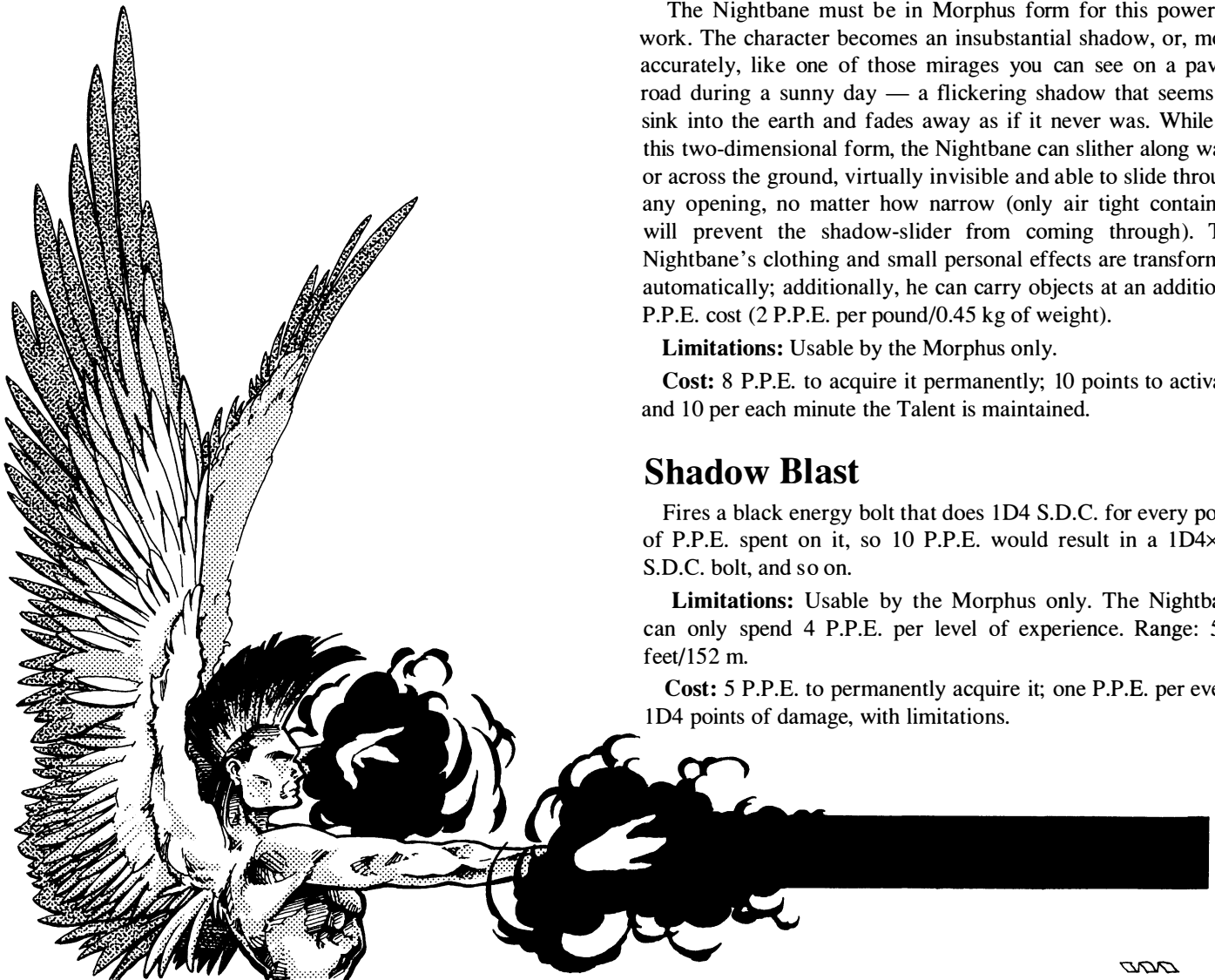

Limitations: Range: line of sight up to 300 feet (91.4 m) away.

Cost: 3 permanent, 2 points to activate, +4 to increase save number by one.

Shadow Shield

Creates a force field of dark energy around the Nightbane, providing 20 S.D.C. per 2 P.P.E. spent (P.P.E. spent cannot exceed 4 per level of experience). The Shadow Shield completely surrounds the character, protecting him from toxic gases, disease, punches, bullets, heat, fire, and similar dangers as long as it remains in force; it is the shield that takes the damage inflicted by such attacks.

Duration: 30 minutes per level of experience or until all the S.D.C. of the shadow shield is used up.

Limitations: Usable by the Morphus only; 4 P.P.E. points or 40 S.D.C. per level of experience.

Cost: 7 P.P.E. to acquire it permanently; 2 P.P.E. to activate with 20 S.D.C. plus additional P.P.E. to increase the level of protection.

Shadow Slide

The Nightbane must be in Morphus form for this power to work. The character becomes an insubstantial shadow, or, more accurately, like one of those mirages you can see on a paved road during a sunny day — a flickering shadow that seems to sink into the earth and fades away as if it never was. While in this two-dimensional form, the Nightbane can slither along walls or across the ground, virtually invisible and able to slide through any opening, no matter how narrow (only air tight containers will prevent the shadow-slider from coming through). The Nightbane's clothing and small personal effects are transformed automatically; additionally, he can carry objects at an additional P.P.E. cost (2 P.P.E. per pound/0.45 kg of weight).

Limitations: Usable by the Morphus only.

Cost: 8 P.P.E. to acquire it permanently; 10 points to activate and 10 per each minute the Talent is maintained.

Shadow Blast

Fires a black energy bolt that does 1D4 S.D.C. for every point of P.P.E. spent on it, so 10 P.P.E. would result in a 1D4×10 S.D.C. bolt, and so on.

Limitations: Usable by the Morphus only. The Nightbane can only spend 4 P.P.E. per level of experience. Range: 500 feet/152 m.

Cost: 5 P.P.E. to permanently acquire it; one P.P.E. per every 1D4 points of damage, with limitations.

Sharing the Flesh

This is a strange and horrific healing spell. The Nightbane touches an injured person to magically transfer the other person's wounds, injury and pain to himself. The person being healed falls into a coma or sleep that lasts 1D4 melee rounds and then awakens completely well. The effect is often gruesome, with nasty wounds spontaneously appearing on the Nightbane as the subject heals. The Nightbane can transfer as much damage as he or she can tolerate, which may be a little amount to all. This is actually a painful sacrifice on the part of the Nightbane as he/she heals as normal — fortunately, these creatures heal rapidly compared to humans.

Limitations: Usable only while in the Morphus form and the Nightbane must perform this act of sacrifice of his own free will. Healing critically injured/comatose characters requires the Nightbane to temporarily expend 24 P.P.E. points and 100 of his S.D.C. and/or hit points to stabilize the injured person and heal the most serious injuries (brings the character up to 2D6 hit points). However, the pain and shock to his system will put the Nightbane in a coma for 2D4×10 minutes. A Nightbane with less than a 100 S.D.C./hit points available at the time can perform the same healing but will die in the process.

Cost: 2 P.P.E. to acquire it permanently; 8 to activate (see above for coma cases).

The Shroud

This powerful Talent enables a Nightbane to become invisible and noiseless to both the normal vision and senses as well as to electronic devices like cameras, motion detectors, heat sensors, etc. This ability can be used selectively, enabling some people to see the character while others can't. Vengeful Nightbane have been known to drive a human insane by pursuing him in plain sight, invisible to everyone else. The victim's cries for help would be useless, for nobody else can see the monster threatening him!

The power is very expensive to maintain for long periods of time (10 P.P.E. per minute). Also, the moment the Nightbane attacks anybody (he can threaten, scream or make gestures all he wants), the Talent stops working and he becomes visible for all to see. Likewise, a Nightbane actively engaged in combat or other activity, or standing in plain sight, cannot activate this Talent to disappear. First, he must get out of sight.

Limitations: Usable only by the Morphus.

Cost: 12 P.P.E. to acquire it permanently; 10 P.P.E. to activate per each minute in effect.

Soul Shield

Protects against mental attacks/probes and the See Truth Talent. The Soul Shield acts like a psychic mind block, preventing most means of magical or psionic probes from intruding into the Nightbane's mind. More importantly, while the Soul Shield is up, any spell or power that tries to control or dominate the Nightbane's mind will automatically fail.

Those who attempt to read the protected character's mind will see only a pool of utter darkness. The mind reader/psychic will find it very difficult to pry himself from that darkness (a save versus psionics is necessary; roll every melee round), and until

he does, he will be unable to do anything other than stare vacantly into space.

Limitations: Usable by the Morphus only. Duration: One hour.

Cost: 6 P.P.E. to acquire it permanently; 4 to activate.

Splittin' Image

This powerful ability enables the Nightbane to separate his Facade and Morphus forms and act normally in both of them! The Nightbane in effect, becomes two people. The character is aware of what both sides are doing, but his consciousness must be focused on one form or the other (he can switch viewpoints at will). The form his consciousness is focused on acts normally; the other appears to lapse into a trance-like state and is at -2 on all combat and perception rolls, has half the normal attacks per melee round, and is at -40% to perform any skills.

Limitations: Usable only by the Morphus only. Not available until 5th level. Duration: One or more hours depending on the amount of P.P.E. expended. The character can merge back into one body at will.

Cost: 15 P.P.E. to acquire it permanently; 20 to activate it for one hour and 10 P.P.E. per each additional hour (can spend the P.P.E. "up front" or as needed).

Storm Maker

This powerful talent enables the Nightbane to control the weather. Rain, winds and the temperature can be altered. The more extreme the changes and the greater the area affected, the more P.P.E. the character must spend. This talent is particularly powerful because two or more Nightbane who know it can combine their efforts (and P.P.E.) to produce an even more powerful effect. There are legends of ancient Nightbane groups sending hurricanes and tornadoes against people who offended or injured them.

The P.P.E. cost varies; the effects take 1D6×10 minutes to manifest, and then lasts one hour. At the end of the hour, the same amount of P.P.E. must be spent to keep it going or it fades away. Some guidelines are given below:

A minor change in existing weather conditions like raising the wind by up to 5 mph (8 kmph), increasing or decreasing cloudiness, intensifying already existing rain, raising or lowering overall temperature by 4 degrees Fahrenheit: 5 P.P.E.

A moderate change of weather conditions like starting rain on an overcast day, turning a downpour into a storm or vice versa, raising or lowering overall temperature by 10 degrees Fahrenheit: 10 P.P.E.

Sudden, major change in weather like starting rain during a clear, sunny day, stopping a downpour, or creating a major thunder or electrical storm during a rainy day, raising or lowering overall temperature by 20 degrees Fahrenheit: 20 P.P.E.

Extreme changes in weather like creating a fog, or starting a hailstorm or electrical storm during a clear, sunny day — or turning a storm into a sunny day, turning a thunderstorm into a tropical storm with near-hurricane winds (70 mph/112 kmph), raising or lowering overall temperature by 30 degrees Fahrenheit: 40 P.P.E.

Total upheaval in weather such as starting a hurricane or tornado from scratch (90+ mph/144 km winds), create a blinding snowstorm, dissipating a hurricane or terrible storm, raising or lowering overall temperature by 50 degrees Fahrenheit: 80 P.P.E.

The base area affected has a radius of one mile (1.6 km). Each additional mile of radius doubles the previous P.P.E. cost. For example: causing a moderate change in the weather costs 10 P.P.E. for one mile/1.6 km, 20 P.P.E. for two miles/3.2 km, 40 P.P.E. for three miles/4.8 km, and 80 P.P.E. for a four mile/6.4 km radius.

Limitations: Usable only by the Morphus. Not available until reaching 5th level.

Cost: 20 P.P.E. to acquire it permanently; P.P.E. cost varies as described above.

Elite Nightbane® Talents

These powers have certain prerequisites. For instance, animal control abilities apply only to Nightbane who have some elements of those animals in their Morphus.

Elite Talents seem to be an extension of the Nightbane's self-conception, i.e. a machine-man might see himself capable of controlling other machines, but not animals. On the other hand, a biomechanical-animal Nightbane would have access to both types of powers.

Bloodbath

This grotesque power allows the Nightbane to use his own blood to suffocate victims. A stream of blood pours from the character (this inflicts 1D6 points of damage to the character, activating the Talent). The Nightbane is at +3 to strike with it. On a successful hit, the blood will rush into the victim's nose and throat, and cause him to choke! While drowning in blood, the victim is at -2 on all combat actions and is unable to use spells, Talents or any skill that requires concentration. The blood remains alive for 1D4 melee rounds, inflicting 2D6 points of damage at the end of each melee round. A successful save versus non-lethal poison will avoid damage for that round, but the penalties remain. Additionally, a victim unfamiliar with that attack must save versus a Horror Factor of 12 to avoid panicking. If panicked, the penalties for the victim are doubled.

Prerequisite: At least one characteristic from the Stigmata Table.

Limitations: Usable only by the Morphus. Not available until 3rd level. Duration: 1D4 melee rounds.

Cost: 15 P.P.E. for permanent acquisition; 8 to activate plus it inflicts 1D6 S.D.C. points of damage on the user.

Deus Ex Machina (Machine Control)

The Nightbane can control machines from cars to microwaves, to lamps or weapons. One device can be controlled for every three points of I.Q. he has (thus, a Nightbane with an I.Q.

of 13 could control 4 machines). The machines can then be made to do anything within their capabilities. For example, a lamp can turn itself on or off, but nothing else. A car or a motorcycle could start its motor and ride off (until it left the range of the effect). While the Nightbane can control several machines, only one of them can be directly controlled on an action-by-action basis. The remaining mechanisms can be given a general order for the rest of the round.

Example: The aforementioned Nightbane is trapped in a house by a number of NSB agents. Trying to create a diversion, he activates Deus Ex Machina and takes control of four machines, including a desk-top computer, a laser printer, a lawn mower just outside the house, and a lamp on the desk. He first orders the office machines to start the diversion, the lamp will turn itself on and off for a melee round, the computer will start making noise at the top of its Soundblaster speakers, and the laser printer will start spitting blank pieces of paper. As the NSB are distracted by the noises coming from the office, the Nightbane takes full control of the lawn mower and sends it roaring into their midst! As the agents shoot the hapless machine to pieces, the Nightbane quietly slips out the back. In a pinch, the character can also seize control of guns and even explosive devices to prevent them from firing (or detonating) or to shoot (explode) whether the user wants them to or not.

Prerequisite: At least one biomechanical characteristic.

Limitations: Usable by the Morphus only. Not available until the third level. Duration of control: One minute; Range: 300 feet (91.4 m).

Cost: 12 P.P.E. to acquire permanently; 4 to activate plus 6 for each additional minute of control or 20 for an additional 100 foot (30.5 m) radius of control.

Swarm Self

Causes the Nightbane's body to separate into 2D4×10 tiny animals of the same animal type as the character (see prerequisites, below). The Nightbane controls this swarm and is aware of everything they do or see. Each swarm member has 5 S.D.C. and 1 Hit Point. In combat, they do 1 point of S.D.C. damage individually or 5D6 S.D.C. from a group or swarm of 10 or more every melee round (all 10 attack one target; several groups of 10 can attack different targets).

The swarmlings have the same combat bonuses as the Nightbane when attacking individually; they are small targets, requiring a called shot at -5 to hit! If attacking as a group, each group of 10 will automatically swarm over a target in 3-5 seconds (equivalent to a melee attack/action) and inflict the damage at the end of each melee round. Attacks on the swarm have no modifiers to hit; a swarm of 10 critters will have 50 S.D.C. and 10 Hit Points. If the swarm takes more than half its S.D.C. damage, it means that half of the critters are dead, damage is reduced to 2D6. When all the S.D.C. is depleted, this means that only two swarmlings remain, and they attack and defend normally (see above).

The hit point (not S.D.C.) damage taken by the swarm carries over to the Nightbane's hit points after the swarm is destroyed or recalled. The swarmlings do not regenerate damage and the character must switch back to his normal Morphus form and limp away. At least two of the swarmlings must be present for



the Nightbane to rebuild himself, but most retreat and reform when reduced to 10 or 15. If all are destroyed, then the Nightbane is slain.

Prerequisite: At least one characteristic from the Animal or Insect Form Table. The creatures will be small versions of the animal. For example: A character with avian characteristics will be able to separate into a swarm of birds, a rodent into a swarm of rats or mice, arachnids into spiders or scorpions, insects into wasps bees or biting flies and so on.

Limitations: Usable by the Morphus only. Range: Self; once a swarm, the range is unrestricted.

Cost: 15 P.P.E. to acquire permanently; 10 to activate for the first two minutes and an additional 10 points for each additional two minutes.

Lord/Lady of the Wild (Animal Control)

The Nightbane gains mastery over any animal species he/she is associated with; thus, a wolf-life Nightbane will be able to control wolves and any canine animal, while a bird-like character would gain powers over all birds. The power has variable range and effects, depending on the amount of P.P.E. the Nightbane spends. Simple commands like “Come here,” “Attack this man,” “Go,” or “Make a lot of noise” will be readily heeded. A character with this power can also make animals behave in unnatural ways, like attacking armed men, something most animals will never do, dance in circles, leap through a wall of fire, etc., but this will cost more P.P.E. Some guidelines are described below:

Calling animals: Any animals of the appropriate species will come from up to a one mile (1.6 km) radius per level of experience: Costs 2 P.P.E. Once they get there, the animals will revert to normal unless new commands are given.

Minor, non-dangerous actions: Like making noise, hiding, fluttering about, or acting in fairly normal ways: Costs 1 P.P.E. per large animal or per group of up to ten small animals (rat/pigeon-sized or smaller).

Dangerous actions: Threatening humans, bite/attack, leap at, block or otherwise hindering armed humans, or behavior that goes against the animal’s normal behavior (asking a nocturnal animal to operate in the daytime, etc.): Costs 5 P.P.E. per large animal or per group of up to ten small animals.

Suicidal actions: Recklessly attacking humans or supernatural beings, intercepting vehicles (a flock of birds can bring down a plane by flying into its engines), fight to the death, and other suicidal or utterly unnatural acts: Costs 10 P.P.E. per large animal or per group of up to ten small animals.

Prerequisite: At least one characteristic from the Animal Form Table.

Limitations: Usable by the Morphus only. Not available until fourth level. Control is limited to the appropriate species. Range: One mile (1.6 km) to summon, 500 feet (152 m) to control/command. Duration: 15 minutes.

Cost: 15 to acquire permanently; activation varies as described above.

Magical O.C.C.s and R.C.C.s

Sorcerer O.C.C.

Over the centuries, many cultures have studied the secrets of magic. For many, the mastery of the arcane arts involved the meticulous study of ancient formulas, spells, and incantations. As the study of magic became unpopular or even persecuted, the sorcerers hid and pursued their search for knowledge in secret. These are the organized and “civilized schools” of magic that originated in ancient Egypt, Greece and Persia, unlike shamans and other “primitive” schools of magic (see the Mystic O.C.C. for information on the shamanistic paths of magic). Sorcerers believe that learned knowledge is the secret to magic. Their approach to wizardry is similar to the methods of scientists and scholars, which depends on the accumulation of information. Unlike mystics, sorcerers depend only on their wits, knowledge and the magical energies of the world to achieve results.

These modern-day wizards tend to be bookish, scholarly types. New students are usually discovered in colleges and universities, often involved in obscure research projects for the less well-known departments of history, archaeology and occult sciences. They are chosen for their belief in the mysterious and their dedication to mastering reality with the force of their own will. Under their nerdish exteriors, there often lies the heart of an adventurer, willing and able to take on any dangers to learn a little more.

Some sorcerers succumb to the thirst for power, and become self-serving scoundrels who exploit “mere mortals” with their powers. Others try to defend humankind with their hard-learned spells and incantations, usually trying to hide their powers to avoid fear and persecution. The majority tend to concentrate on learning ever more and become detached and sometimes even oblivious to the world around them. After Dark Day, however, even the most absent-minded magician knows that supernatural invaders threaten everything they hold dear, and that their “ivory towers” of scholastic knowledge will offer them no protection.

Through their studies, Sorcerers have developed mystical senses that attune them to ley lines, nexus points, and other mystical “hot spots.” They have also learned of the Nightlands, and some of them know spells and rituals that let them peer into that mysterious world. Most of them know little about the Ba’al and their minions and are now learning the hard way just how dangerous those beings truly are. As students of the occult, Sorcerers have sometimes made contact with Nightbane and have even taught a few the arts of magic (see the **Nightbane Sorcerer O.C.C.**).

O.C.C. Abilities and Bonuses:

1. Understand the principles of magic: Sorcerers know and understand the main principles of magic and sorcery, including rituals, symbols, incantations and paraphernalia. This allows



them to distinguish between fake “occult” materials and the real thing, as well as to determine the general purpose of specific items and even which supernatural forces are involved. **Base Skill:** 70% +2% per level of experience. A failed roll means the character does not realize or misunderstands the significance of the evidence, dismissing it as fake or maybe even thinking a forgery or charlatan’s scribbles are authentic.

2. Sense Ley Lines and Nexus Points: The sorcerer’s senses enable him to see ley lines, which are invisible to normal humans. The character will “see” the faint traces of psychic energy running down the ley lines or seething at nexus points. **Range:** Line of sight or one mile (1.6 km), whichever is less.

3. Initial Spell Knowledge: The sorcerer has the dedication, understanding and powers to focus and concentrate to cast magical invocations, read magic, and learn spells. At first level, the sorcerer may select three spells from each magic level one to four, for a total of twelve spells (three from each). Each additional level of experience, the character will be able to figure out/select one new spell equal to his own level of achievement/experience.

4. Learning New Spells: Additional spells and rituals of any magic level can be learned or purchased at any time, regardless of the sorcerer’s experience level. See the *Pursuit of Magic* in the **Magic Section** for details.

5. Magic Bonuses: +4 to save vs magic, +4 to save vs possession, +2 to save vs mind control, and +4 to save vs horror factor.

6. P.P.E.: Sorcerers become living batteries of mystic energy. The base P.P.E. of the sorcerer is determined by rolling 1D6×10

and adding it to the P.E. attribute. Add 2D6 P.P.E. per level of experience.

Attribute Requirements: I.Q. 12, M.E. 10, and P.E. 12.

O.C.C. Skills:

Read/Write/Speak Native Language 98%

Mathematics: Basic (+25%)

Computer Operation (+15%)

Research (+25%)

Two Lore skills of choice (+20%)

Two languages of choice (+15%)

One additional technical skill of choice (+15%)

Hand to band: basic can be selected as one “other” skill, hand to hand: expert at the cost of two “other” skills, or martial arts (or assassin if an evil alignment) for the cost of three “other” skills.

O.C.C. Related Skills: Select ten other skills, but two must be from the science category. Plus select two additional skills at level three, one at level six, one at level nine, and one at level twelve. All new skills start at level one proficiency.

Communications: Any (+5%)

Domestic: Any (+10%)

Electrical: Any

Espionage: Intelligence and wilderness survival only.

Mechanical: Any

Medical: Any (+5%)

Military: None

Physical: Any

Pilot: Any (+5%)

Pilot Related: Any

Rogue: None
Science: Any (+10%)
Technical: Any (+10%)
W.P.: Any
Wilderness: Any

Secondary Skills: The character also gets to select six secondary skills from those listed. These are additional areas of knowledge that do not get the advantage of the bonus listed in parentheses. All secondary skills start at the base skill level.

Standard Equipment: Varies. Most sorcerers own a small library (with books on history, the occult, myths and legends, etc.), a personal computer, pocket tape recorder, note pad, magnifying glass, backpack, work, casual and dress clothes, an inexpensive car or jeep, and other useful items.

Money: 3D6×100 +200 in cash, and 3D6×1,000 in property (includes equipment, vehicles and similar items).

Mystic O.C.C.

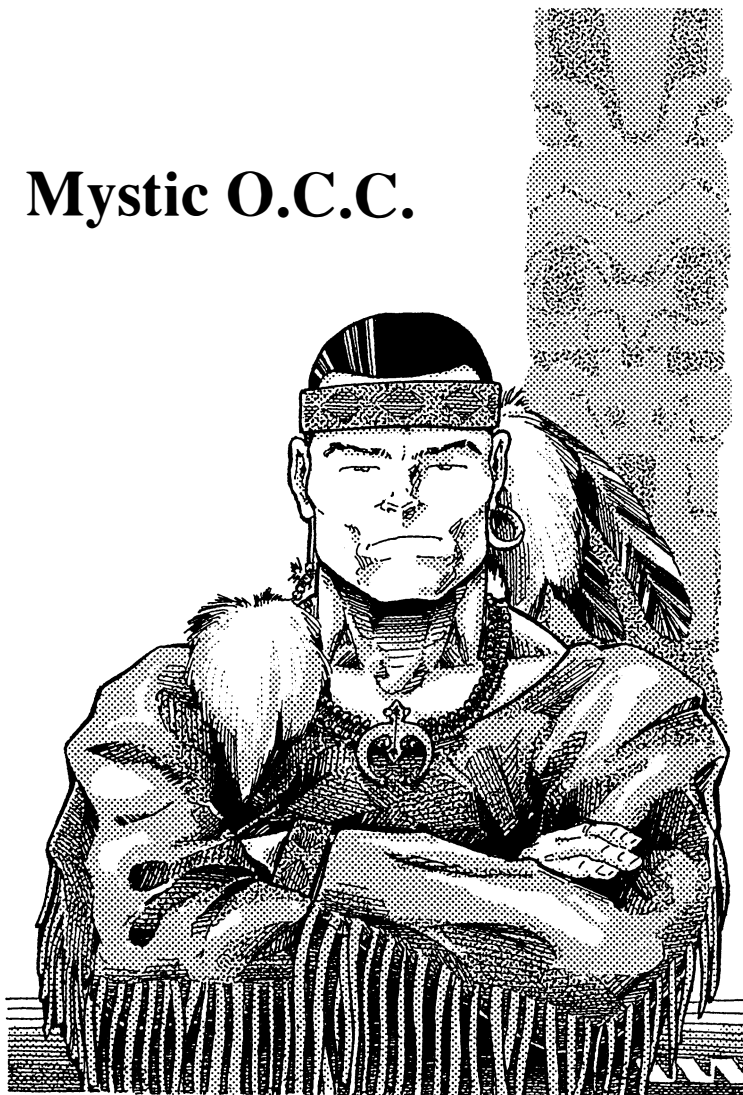

Sorcerers with their books and scrolls and complex studies represent one side of the magical coin. The other can be found among primitive peoples, and includes rainmakers, shamans and medicine men. The magical knowledge of these mystics is intuitive rather than rational. The mystic simply accepts the fact that they suddenly know something and have learned to trust their feelings and hunches. Where sorcerers research and practice, mystics meditate and disregard formal education in favor of fol-

lowing a “cosmic” or “spiritual” path. They open themselves to the realms of magic, and their magic is no less effective for being granted from outside themselves.

Mystics not only have magical powers, but their connection to the natural psychic emanations of the world gives them a number of psionic powers as well. There is the power to sense the presence of the supernatural; mystics from a hundred cultures were instantly aware that the world was being invaded moments before Dark Day started. Many of them have chosen to fight the enemy at all costs.

For the most part, mystics live in areas/cultures removed from the chaos and materialism of the “civilized” world. In the U.S., many mystics are Native Americans living on reservations, as well as Caribbean practitioners of Voudoun or Santeria, gypsies, neo-pagans, Taoist mystics, etc. An individual can be taught the ways of mysticism, usually involving philosophy, meditation, and an opening of one’s mind and body to the world. Many mystics claim that one does not learn to become a mystic, but is born with the gift.

O.C.C. Abilities and Bonuses:

1. Psychic Powers: At first level, the mystic gains the following powers: clairvoyance, exorcism, sense evil and sixth sense. Select three additional abilities from the Psychic Sensitive category and two from the Healer category. At levels three, five, seven and ten, select an additional power from either of those two categories. Considered to be a major psionic. **I.S.P.:** 1D4×10 plus the character’s M.E. number. Add 1D6+1 I.S.P. per each additional level of experience.

2. Initial Spell Knowledge: Like everything else, the mystic’s spell knowledge comes from within the character himself, on an intuitive level. The character spends years pondering about life, his place in it, and how magic might help him find that place in the world. If the character’s outlook is happy/optimistic, the spells are likely to be of a helpful, healing, protective and defensive nature. If the outlook or goal is power, wealth and prestige, the spells are likely to be of a more aggressive and offensive nature. A dark view of the world will result in spells that are defensive and revealing, as well as a few offensive ones. At the end of this period of contemplation, focus and development (usually taking years), the mystic finds himself gifted with magical powers.

At first level, select a total of six spells from the first and second magic levels. Once selected, they cannot be changed.

3. Learning new spells: The mystic will intuitively sense when he or she has reached a new metaphysical plateau (new level of experience). At each new junction in life, the character will find the time to meditate on life, his goals, and magic.

At second level of experience, the mystic can select a total of three additional spells from levels one, two, and three. Upon reaching the third level of experience, the mystic can select another three new spells from levels one to four. At fourth level and above, the mystic can select two additional spells from any of the levels, up to his corresponding experience level. Thus, a sixth level mystic can select two spells from any of the levels 1-6. Unlike the sorcerer, the mystic cannot learn spells independently nor is he likely to read symbols, runes or to perform rituals; he is dependent on his intuitive senses to gain all of his magic powers.

4. P.P.E.: 1D4×10 plus P.E. attribute number. Add 1D6+1 P.P.E. per additional level of experience.

5. Bonuses: +1 to save versus psychic attacks, +3 to save vs horror factor, +1 to save vs magic at levels three, six, nine and twelve, and +1 to spell strength (the number others must save against when you cast a spell) at levels four, eight, and twelve.

Attribute Requirements: I.Q. 9, M.E. 9 and M.A. 9 or higher.

O.C.C. Skills:

Read/Speak Native Language 98%

Select one additional language (+15%)

One Lore skill of choice (+20%)

Dance (+10%)

One Domestic skill of choice (+10%)

Hand to hand: basic can be selected as one “other” skill, hand to hand: expert at the cost of two “other” skills, or martial arts (or assassin if an evil alignment) for the cost of three “other” skills.

O.C.C. Related Skills: Select ten other skills, but at least two of them must be technical. Plus select one additional skill at levels three, six, nine, and twelve. All new skills start at level one proficiency.

Communications: Any

Domestic: Any (+5%)

Electrical: None

Espionage: Wilderness survival only (+10%)

Mechanical: None

Medical: Holistic Medicine only (+10%)

Military: None

Physical: Any

Pilot: Any

Pilot Related: Any

Rogue: Any

Science: Any

Technical: Any (+10%)

W.P.: Any

Wilderness: Any (+5%)

Secondary Skills: The character gets to select six secondary skills from those listed. These are additional areas of knowledge that do not get the advantage of the bonus listed in parentheses. All secondary skills start at the base skill level.

Standard Equipment: Most mystics will own very little, typically a pair of walking shoes, boots, a pair of gloves, a hat, travelling cloths, rain/trench coat, knapsack, backpack, mirror, portable radio or CD player, staff or walking stick and personal items.

A few of the more wealth-oriented ones may find themselves owning a huge mansion, a fleet of vehicles and other symbols of wealth and prestige. On the downside, these mystics are very rare, because they were easily found and destroyed during the days following Dark Day.

Money: Average Mystic: 2D6×100 in cash and 1D6×1,000 in possessions. Wealth-oriented Mystic: 4D4×1,000 in cash and 4D6×10,000 in possessions (includes housing, vehicles and equipment).



Nightbane® Sorcerer O.C.C.

Nightbane Sorcerers are a very rare breed; they are normal Nightbane that have been trained in the mystic arts, usually at the hands of a human sorcerer. About half of these characters were apprentices who never realized their supernatural natures until the time of their Becoming. The rest were discovered by sorcerers who decided to train them in the arts of magic. Some ancient Nightbane in the Underground Railroad are sorcerers and occasionally pass along their knowledge to worthy students.

Nightbane who choose to follow the path of magic face a difficult life. The demands of learning magic often conflict with the visualization needed to develop their Talents. Thus, the sorcerers end up being somewhat less effective at either specialty than either a dedicated human sorcerer or a normal Nightbane. On the other hand, the character can draw from both sources of power at will.

O.C.C. Abilities and Bonuses:

1. Understand the Principles of Magic: Same as the Sorcerer O.C.C.

2. Sense Ley Lines and Nexus Points: Same as the Sorcerer O.C.C.

3. Initial Spell Knowledge: The sorcerer has the dedication, understanding and powers of focusing and concentration to cast magical invocations, read magic, and learn spells. At first level, the Nightbane sorcerer may select three spells from each

magic level one to four, for a total of twelve spells (two from each). Each additional level of experience, the character will be able to figure out/select one new spell equal to his own level of achievement/experience.

4. Learning New Spells: Additional spells and rituals of any magic level can be learned or purchased at any time regardless of the sorcerer's experience level. See the *Pursuit of Magic* in the **Magic Section** for details.

5. Magic Bonuses: +3 to save vs magic, +2 to save vs horror factor, and +2 to save vs possession.

6. P.P.E.: The P.P.E. base of the Nightbane sorcerer is the same as that of all members of his race: $3D6 \times 10 + 20$ plus the P.E. attribute. Add $2D6 + 6$ per level of experience. Some of this P.P.E. is often "burned off" when purchasing Talents.

7. Nightbane Abilities: The character has all the natural powers of the Nightbane R.C.C.; see it for more details.

8. Talents: The Nightbane Sorcerer gains only one Talent at first level and gets no new Talents at later levels. He can buy more Talents, at the cost of permanent expenditure of P.P.E., but this will also limit the number of spells he can use.

Attribute Requirements: I.Q. 12 and M.E. 12.

O.C.C. Skills:

Read/Write/Speak Native Language 98%

Mathematics: Basic (+25%)

Computer Operation (+10%)

Research (+20%)

Two Lore skills of choice (+15%)

Two languages of choice (+15%)

One additional technical skill of choice (+10%)

Hand to hand: basic can be selected as one "other" skill, hand to hand: expert at the cost of two "other" skills, or martial arts (or assassin if an evil alignment) for the cost of three "other" skills. This hand to hand affects the Facade form only; the Morphus has natural combat powers roughly equivalent to the martial arts skill.

O.C.C. Related Skills: Select eight other skills, but two must be from the science category. Plus select two additional skills at level three, and one at levels six, nine, and twelve. All new skills start at level one proficiency.

Communications: Any (+5%)

Domestic: Any (+10%)

Electrical: Any

Espionage: Intelligence and wilderness survival only.

Mechanical: Any

Medical: Any (+5%)

Military: None

Physical: Any

Pilot: Any (+5%)

Pilot Related: Any

Rogue: None

Science: Any (+10%)

Technical: Any (+10%)

W.P.: Any

Wilderness: Any

Secondary Skills: The character also gets to select four secondary skills from those listed. These are additional areas of knowledge that do not get the advantage of the bonus listed in parentheses. All secondary skills start at the base skill level.

Standard Equipment: Varies. Most sorcerers own a small occult library, a personal computer, and other useful items.

Money: $3D4 \times 100 + 200$ in cash and $2D4 \times 1,000$ in property (includes equipment, vehicles and similar items).

Nightbane[®] Mystic O.C.C.

This is the most common magic-practicing Nightbane, one of the few who have a natural understanding of the energies coursing from the Nightlands to Earth. In many primitive or nature-oriented cultures, Nightbane were often considered to be "touched by the spirits" and blessed with the power to become the living embodiment of their totem spirits (perhaps for that same reason, animal-like Morphi are most common among the Nightbane of those cultures). Consequently, they were considered to be prime candidates to follow the path of mystical revelation.

O.C.C. Abilities and Bonuses:

1. Psychic Powers: Unlike human mystics, Nightbane have no psionic potential whatsoever. Instead, they rely on their Talents to be in tune with the world.

2. Initial Spell Knowledge: At first level, the Nightbane gets to select a total of five spells from the first and second magic levels.

3. Learning new spells: At second level of experience, the Nightbane Mystic can select a total of four additional spells from levels one, two, and three. Upon reaching the third level of experience, the mystic can select two new spells from levels one to four. At fourth level and above, the mystic can select one additional new spell from any of the levels, up to his corresponding experience level. Unlike the sorcerer, the mystic cannot learn spells independently; he is dependent on his intuitive senses to gain his magic powers.

4. P.P.E.: The P.P.E. base of the Nightbane mystic is the same as that of all members of his race. $3D6 \times 10 + 20$ plus the P.E. attribute. Add $2D6 + 6$ per level of experience. Some of this P.P.E. is often "burned off" when purchasing Talents.

5. Bonuses: +1 to save versus psychic attacks, +2 to save vs horror factor, +1 to save vs magic at levels three, six, nine and twelve, +1 to spell strength (the number others must save against when you cast a spell) at levels four, eight, and twelve.

6. Nightbane Abilities: The character has all the natural powers of the Nightbane R.C.C. see it for more details.

7. Talents: The Nightbane mystic gains one Talent at first level, and an additional Talent at levels three, seven, eleven and fifteen. Additional Talents may be purchased with P.P.E. points, but seldom more than one or two are ever purchased (it is not natural for a mystic to "force" matters).

Attribute Requirements: I.Q. 10, M.E. 9 and M.A. 9 or higher.

O.C.C. Skills:

Read/Speak Native Language 98%

Select one additional language (+10%)

One Lore skill of choice (+15%)

Dance (+10%)



Hand to hand: basic can be selected as one “other” skill, hand to hand: expert at the cost of two “other” skills, or martial arts (or assassin if an evil alignment) for the cost of three “other” skills. This selection only affects the Nightbane’s Facade; the Morphus instinctively knows the equivalent of hand to hand: martial arts.

O.C.C. Related Skills: Select seven other skills, but at least two of them must be technical. Plus select one additional skill at levels three, six, nine, and twelve. All new skills start at level one proficiency.

Communications: Any

Domestic: Any (+5%)

Electrical: None

Espionage: Wilderness survival only (+10%)

Mechanical: None

Medical: Holistic Medicine only (+10%)

Military: None

Physical: Any

Pilot: Any

Pilot Related: Any

Rogue: Any

Science: Any

Technical: Any (+10%)

W.P.: Any

Wilderness: Any (+5%)

Secondary Skills: The character gets to select four secondary skills from those listed. These are additional areas of knowledge that do not get the advantage of the bonus listed in parentheses. All secondary skills start at the base skill level.

Standard Equipment: Most mystics will own very little. A few of the more wealth-oriented ones may find themselves owning property, vehicles, equipment and stocks and bonds. On the down-side, these mystics are very rare, because they were easily found and destroyed during the days following Dark Day.

Money: Average Mystic: 2D6×100 in cash and 1D6×1,000 in possessions. Wealth-oriented Mystic: 2D4×1,000 in cash and 4D6×10,000 in possessions (includes housing, vehicles and equipment).

Magic

By Kevin Siembieda & C.J. Carella

Please Note: Throughout this section, magic is treated as a real, existing force, complete with theories and history. This is done for dramatic purposes. We must again express that this is purely a fictional work and actually has no bearing on the *real* world!!

The magic system described below is based on the system found in **Beyond the Supernatural** and **Rifts**. The major differences between **Nightbane** and those two RPGs revolve around the influence of the *Nightlands* on the magic practices of this game world. Among other things, since the Dark Day, the level of magical energy in this world is somewhere between the “weak” energy fields of **Beyond the Supernatural** and the “strong” ones on Rifts Earth. As a result, magic and psionic powers have more energy available, as well as additional potency and increased effects. Many new spells have been developed in this world, while others that are common in **Beyond The Supernatural** and **Rifts** are less well-known. Game Masters can add any spells from either of those games and their supplements if they feel they are appropriate (being careful to modify mega-damage magic to S.D.C. levels).

How Does Magic Work?

The basic concepts behind magic are simple. First, Magic is a natural force that has existed since the dawn of time. In earlier times, it was widely practiced by primitive cultures. It is believed that the Ba'al (now known as the Nightlords) were powerful sorcerers who were banished for delving into forbidden spells. Eventually, most cultures of humankind lost the secrets of magic and turned to science. Over the generations, magic became a myth, an element in the pages of fantasy and legends. A few isolated cults and groups of magicians conducted spells and rituals in secret, but to most people, it ceased to exist. The secrets were jealously guarded by individual magicians and small covens and sorcerers' circles.

Unknown to all but a few mystics and occultists, magic is a constant and ever present energy, like electromagnetism. Some parapsychologists call this energy **Potential Psychic Energy (P.P.E.)**. They called it “Potential” because everybody seems to possess a certain amount of this energy, yet only a few are able to draw upon it in a *paranormal* or magical way.

Magical energy runs in natural (but invisible) “rivers” and “streams” of potential psychic energy. These “streams” are called *ley lines*, and they run across the planet like an invisible web of mystic energy. The location where two or more ley lines cross over each other is called a *ley line nexus* or energy junction. P.P.E. is at its greatest strength at nexus points. Before humankind lost its belief in magic, it knew about ley lines and nexus points and marked these spots with stone circles and towers known as megaliths. In North America, the ancients marked

these places with huge mounds or animal effigies. In Central America and Egypt, great pyramids were erected.

Many of these places have long histories as sacred, magical, or haunted. Some were said to have healing powers, while others were attributed to be portals to hell! Ley lines and nexus points are places where the barriers of reality are weakened, allowing for the entrance of supernatural visitors from other dimensions. In the **Nightbane** world, ley lines and nexus points are intimately linked to the *Nightlands*.

Many of the megaliths, stone circles and pyramids also had astronomical significance. The buildings indicated the dawn of winter and summer solstice, planetary alignments, and other astronomical occurrences. These occurrences somehow caused the P.P.E. levels to dramatically increase for a brief period, lasting a few minutes to several hours. On these occasions, a man of magic could utilize the sudden burst of energy to create powerful magic or know that this was a time of danger and the area was to be avoided. The danger was that dimensional portals or “Rifts” would sometimes tear open, releasing strange and horrible monsters from other dimensions into our own. Most, but not all, of these Rifts open up into the *Nightlands*, releasing some of their monstrous inhabitants into our world. It is likely that the *Nightbane* are orphans from another world, or maybe humans who were transformed by other-dimensional energies.

Assuming all this is true, why was magic virtually unknown to modern man?

Investigations revealed that monsters may have certainly existed. All types of supernatural and magical phenomena were ignored or explained away with semi-rational explanations like mass hysteria, hoaxes, swamp gas, hypnosis, insanity, and so on. The more spectacular occurrences were accepted as “the unexplainable,” but relegated to late night TV specials, exploitive books, and sensationalistic tabloids, and forgotten. Modern man simply refused to believe in the paranormal and magic.

This refusal to believe may actually date back to ancient times. Many ancient cultures of the Middle East speak of an ancient war between the forces of Light and Darkness, that involved the Dark Lords (or Ba'al) and the Lords of Light. It is not clear whether the Lords were sorcerers, demons from another dimension, powerful *Nightbane*, ancient gods or their agents. When the war was over, the evil sorcerers had been banished into the Lands of Night (where they became the *Nightlords*). The devastating war and the horrors brought about by magic terrified the survivors. From that day on, magic was feared, its practitioners shunned and often forced to conduct their rituals in secret. Magic was forever tainted as an uncontainable force of destruction or evil. The Wars of Light and Darkness, and the evil the *Nightlords* often visited upon magicians, lingered and kept the old fears alive. Over the centuries, these fears caused magic to

become hidden and largely forgotten. During the Age of Reason, the knowledge had been so thoroughly lost that humankind believed it to be fantasy and no longer believed in it at all. Beneath the refusal to believe, however, there was the lingering fear that, even if it existed, magic was not a force to be used for anything but evil (as evident during the witch hysteria of several generations).

This refusal to believe in the paranormal is the single most significant reason why modern man has lost the secrets of magic. At best, so-called magic is a metaphysical phenomenon that functions on a different level of understanding than the laws of science held dear by modern people. Mental discipline and belief are the two keys to unlocking the secrets of magic. Without them, magic is impossible.

This explained why some people could perform magic or possessed psychic powers and others did not. Theoretically, everybody has potential psychic energy and at some point in life, has a great deal of it. As human beings mature both physically and mentally, their P.P.E. changes. The average adult has little P.P.E., yet an average teenager has more than at any other time in his life. What happens is that the P.P.E. energy is used up in one way or another. Its most constructive use is focusing on a particular area of interest. This could be where the concept of a natural talent and genius arises. A person's focus to develop a particular skill/talent is so strong that the potential psychic energy is channeled into developing that specific area. But this is only a fraction of what is possible by focusing and developing one's P.P.E., the individual can develop psychic or magic powers too.

The Return of Magic

Dark Day started a process in which an alien dimension became more closely aligned to Earth. Dormant energies held in check since the mythical Wars of Light and Darkness were once again unleashed into the world. As a result, the amount of available P.P.E. was greatly increased, both on the personal level (in the form of more individual P.P.E.) and worldwide (in terms of the energies available at ley lines and nexus points). More importantly, Dark Day itself and the subsequent events, had a profound effect on the belief in magic. Despite the pathetic, almost desperate attempts of the scientific community to explain Dark Day, most people became convinced that a true supernatural event had occurred. Suddenly, old superstitions, religious beliefs and mysticism seemed a lot less laughable. Science provided cold comfort when the sun didn't come out in the morning.

As a result, there are more people willing to believe in the power of magic than there has been in centuries. Ancient mystical tomes are being dusted off by would-be sorcerers, and ancient mystical societies are finding more worthy pupils. By 2005, the changes are still not readily apparent, but the world is about to undergo a radical shift in beliefs and attitudes. Even if (a big if) the Nightlords are defeated, the Earth will never be the same.

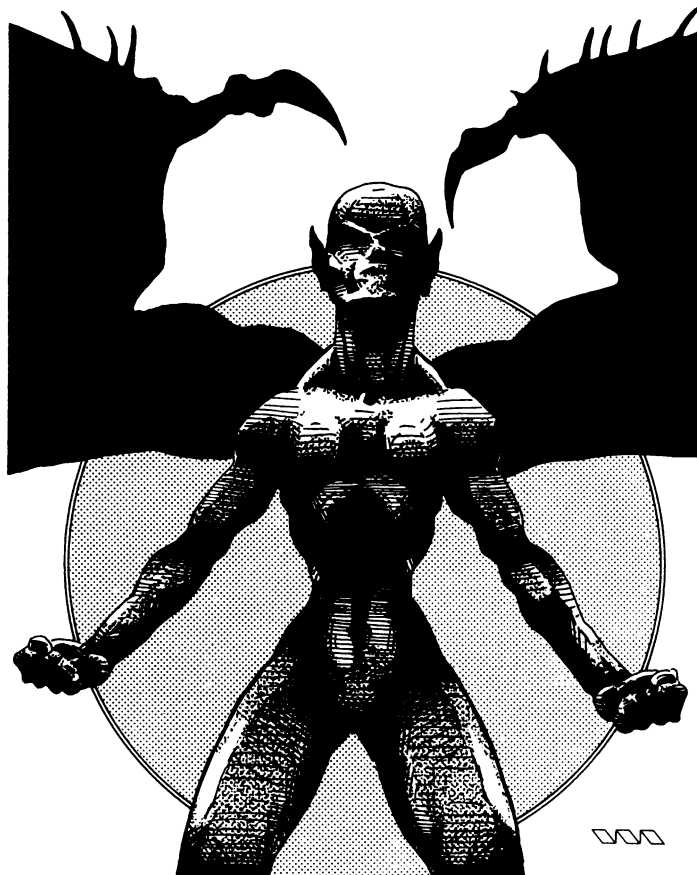

The Mastery of Magic

Step One: Belief

The first step in becoming a practitioner of magic is believing that magic is real and that one can master the knowledge and skill to perform it. The individual must see magic as an innate energy, a tool, that is not to be feared. It is man, not magic, that uses energies for good or evil purposes. This must be a 100% conviction: any glimmer of doubt will destroy any chances of learning magic.

Since most people don't believe in magic, it is lost to them. More importantly, many of those who believe in magic fear it and believe it is evil, a legacy of millennia of such teachings, dating back to the War of Light and Darkness. Both superstitious fears and "rational" disbelief are obstacles in the mastery of magic.

Step Two: Mental Discipline

Theoretically, anybody can learn magic; however, it is an extremely difficult process that proves to be impossible for most people. The young student of the magic arts must decide to channel his mystic development toward a particular focus and to learn mental disciplines akin to Zen or Oriental meditation. The individual must be able to completely rid himself of distracting thoughts and emotions, to concentrate on one thought with razor sharp focus, in order to direct magic forces.

To be an effective mage, the character must take this art of concentration a step further and be able to relax, clear his mind, and focus under the most distracting and frightening conditions.

It is a meditative art that must be learned to perfection. Unfortunately, the human mind is a cluttered and complex machine that is not easily mastered. Thus, the meditation skill alone will require *years* of intense practice and must be continued daily to keep sharp. The pursuit of magic is not for the impatient.

Role-playing Magician Characters: This amount of dedication and concentration should be role-played to depict realistic magician characters. Undisciplined, care-free and “lazy” types are unlikely to be magicians (there are exceptions, like the “prodigy” who hides his/her genius under a pretense of laziness and lack of discipline). Also, sorcerers spend so much time developing and maintaining their talents that they rarely have the time to “waste” with such things as fashion, entertainment, a personal life or even current events!

There are several areas of focus, or “schools of magic.” In this book, those schools are for the Sorcerer or the Mystic. Other forms of magic are also possible, but these two are the most common to Earth. Both disciplines have different outlooks, orientations and objectives, yet each will offer similar magical capabilities, as well as a variety of very different abilities.

The Sorcerer is a master of spell magic, a learned scholar who memorizes and researches his spells, and has a very intellectual outlook towards magic. **The Mystic** develops both magic and psychic powers on an intuitive and emotional level. The two types cover a great deal of different magical traditions. A “hermetic” magician who learned his spells from ancient Latin and Greek tomes would be considered a sorcerer, whereas a Native American Shaman who “learned” his spells as a result of communing with the spirit world would be considered a Mystic. Some Nightbane can learn magic, and they can be either Sorcerers or Mystics (see the **Magical O.C.C.s** and **R.C.C.s** previously described).

Note: Other magical and psychic O.C.C.s, as well as other supernatural monsters, can be found in the pages of **Beyond the Supernatural**.

Step Three: Understanding Magic

Magic is an energy that can be controlled and manipulated by the humanoid mind and force of will. It is a fabulous power that can calm a storm, create a fire ball, or open a door to another world. It is a force that requires no external casing or internal mechanism to use; only the mind. It seems to be an inexhaustible energy that continually renews itself, a force of nature that can be harnessed by a single individual.

Ley Lines, Nexus Points, and P.P.E.

Ley lines are a matrix of natural potential psychic energy that run in *straight lines* across the globe. The source of the energy is unknown and apparently inexhaustible. At places where several ley lines cross, the energy is at its greatest. These P.P.E. intersections are called ley line nexus points.

The Earth of Nightbane has been infused with an enormous amount of magical energy, raising the power levels of magic to a level unknown in centuries. Practitioners of magic, supernatural beings, and demons can all draw energy from these ley lines.

Ley Lines and Magic

Ley lines have the following effects on men of magic.

Close proximity to a ley line. Being near a ley line (within half a mile/0.8 km), increases the range and duration of spells by 50%.

Being at/on a ley line or one mile from a nexus point doubles the range, duration, and *damage* of magic spells. The mage can also draw an additional 5 P.P.E. per level of experience (i.e., a second level mystic could draw on an additional 10 points, a third level mystic 15 P.P.E., etc.) every 12 hours. Plus his own P.P.E. recovers at the increased rate of 8 P.P.E. per half hour without meditation!

Being at a ley line nexus point or within 200 feet (61.0 m) of one triples the range, duration, and damage of magic incantations. The mage also enjoys a bonus of +2 to save vs magic and +2 to save vs Horror Factor. His personal spell strength is also increased by +1. The mage can draw an additional 15 P.P.E. per level of experience every 6 hours. Plus his own P.P.E. recovers at the incredible rate of 15 points per half hour!!

Periods of increased energy at a nexus point. There are also periods of time during the day and year that the ley line energies increase. These increases are most dramatic at the ley line nexus points. It is at these periods that a *Rift* may tear open. It is also at these periods that men of magic can work their most amazing magic. The following are the *additional* amounts of P.P.E. available at specific periods. **Note:** Other, competing and evil forces may also seek out a ley line nexus at these peak moments and may not wish to share the mystic energy (or be seen). Combat may ensue if someone does not yield to the other and leave.

Midday (noon) and midnight: Add 10 P.P.E. per level of the mage.

Vernal (spring) and Autumnal Equinox: Energy runs high during the daylight hours of the vernal equinox and the nighttime hours of the autumnal equinox. During this time a mage may add 50 P.P.E. per level of experience. Note, however, that there is also a 1-15% chance that a Rift will appear (roll once for every light or night hour of the equinox).

Summer and Winter Solstice: Solstice occurs twice a year, when the sun is farthest from Earth’s equator (June 21st, Summer and December 21st, Winter), the longest and shortest days of sunlight a year respectively. These two days send the ley line nexus junctions boiling with energy! The P.P.E. available during the 24 hour period is the same as the equinox and there is a 1-20% chance of a rift opening every hour.

At the dawn of a solstice, the nexus erupts with energy for a five minute period. At this time the mage can tap into 150 P.P.E. per each level of the mage’s experience. However, there is a 1-35% chance that a Rift will also open and remain so for 2D4 hours. Something(s) bad will definitely come crawling out.

At sunset, another, although smaller, five minute energy flare erupts. The sorcerer can add 100 P.P.E. per level of experience. This time there is a 1-25% chance that a dimensional Rift will appear.

A **Lunar Eclipse** occurs when the Earth casts its shadow on the moon. A lunar eclipse happens about once a year and lasts about an hour and a half. During this 90 minute period, practitioners of magic can tap into an extra 200 P.P.E. per level of experience. There is a 1-35% chance of a Rift appearing.

A **Partial Solar Eclipse** occurs when the moon passes between the sun and the earth, but is close enough to the Earth that

the sun is briefly blocked from sight. This rare solar event happens about once every ten years and lasts for about two to eight minutes (roll 2D4). It has a profound effect on ley line junctions. The mage can tap into 500 P.P.E. per level of experience. All spell duration, range, and damage is increased by five times, mages are +6 to save versus magic, and recover P.P.E. at a rate of 30 a minute! There is also a 1-40% likelihood of a gargantuan Rift appearing in the sky. **Note:** The same effects occur when three or more of the planets' orbits puts them in a straight line, about once every 20 years.

Remember, the additional magic energy is only accessible directly at a ley line nexus and must be used while it is available. The P.P.E. can not be saved and used later. This makes timing a critical factor.

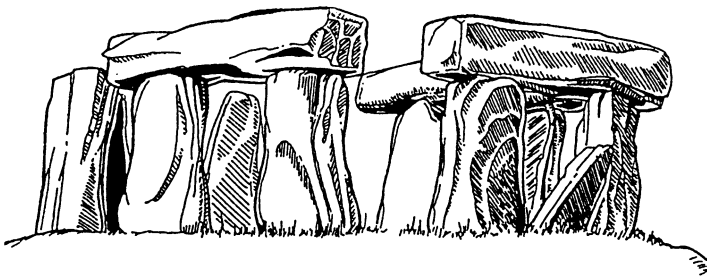

Super Nexus Points

There are about a dozen *known* places in the world where scores of ley lines intersect to create a nexus point of unusual magnitude. These include one super nexus point at 1) Calgary (Canada), 2) Mexico City (Mexico), 3) Andes Mountains (Peru, S. America), 4) The Devil's Gate at St. Louis (Missouri, USA), 5) East St. Louis (Illinois, USA), 6) in the Ohio Valley (Adams county, Ohio, USA), 7) Stonehenge (England), 8) Maes Howe (Scotland), 9) Newgrange (Ireland), 10) Standing Stones of Carnac (France), and 11) The site of the Giza pyramid (Egypt). Presumably, there are super powerful nexus points in places such as the Himalaya Mountains, India, China, Easter Island, Australia, and others, but these are distant lands from the Americas.

The usual available P.P.E. is doubled at super nexus points, but the chance of a rift opening at all peak periods is also increased to 50%.

Random Ley Line Table

The lengths of ley lines can vary from as little as a mile or two (1.6 to 3.2 km) to several hundred miles. The following table will help game masters quickly determine the length of a randomly encountered ley line. All ley lines are about a half mile wide (approximately 2700 feet/823 m). **Note:** One mile is about 1.6 kilometers.

- 01-10 3D4 miles (4.8 to 19 km) long.
- 11-20 3D6 miles (4.8 to 28 km) long.
- 21-30 1D6 miles (1.6 to 9.6 km) long.
- 31-40 2D6 miles (3.2 to 19 km) long.
- 41-50 6D6 miles (9.6 to 58 km) long.
- 51-60 4D6 miles (6.4 to 39 km) long.
- 61-70 2D4×10 miles (32 to 129 km) long.
- 71-80 1D6×10 miles (16 to 96 km) long.
- 81-90 3D6×10 miles (48 to 290 km) long.
- 91-00 5D6×10 miles (80 to 480 km) long.

The Pursuit of Magic

Spells, Rituals, Summoning, and O.C.C. Powers

There are four major categories of magic: spells, rituals, summoning, and special O.C.C. powers.

Spell magic is spoken incantations that serve as a focus to create/cast magic. **The Base Saving Throw** against spell magic is 12. As a mage increases in experience levels, he receives bonuses that increases his spell's strength. For example: The spell of a fourth level mystic has a +1 added to his spell strength. This means his magic is now more potent and victims of his mystic assault must roll a 13 or higher instead of the base 12 to save.

Ritual or ceremonial magic tends to apply to the more powerful magic invocations and may need several participants and require components and the drawing of a circle or pentagram. Any spell incantation from level seven and higher can be cast as a spell or ritual. Spells from level seven through level ten will require a ten minute ritual to cast, but enjoy an enhanced saving throw. Incantations from level eleven to fifteen performed as ritual magic will require 1D6×10+15 minutes to complete.

The Base Saving Throw to save vs ritual magic is 16! Spell strength bonuses are not applicable to *ritual* magic.

Summoning magic can be spell or ritual, but often requires a formal ceremony to summon something, or to create a supernatural force such as a zombie or golem. Control incantations always offer its victims a saving throw of 12 (plus spell strength bonus) if a spell and 16 if a ritual. Most summoning and all creation incantations are automatically successful. Summoning magic is predominately used by sorcerers of evil alignments.

O.C.C. powers are special magic abilities that only practitioners of that particular form of magic can perform.

Learning Spells

Practitioners of magic, except for the mystic, can learn and cast spells far above their actual experience level. This means a second level sorcerer could cast a tenth level spell, providing he has sufficient magic energy. Sorcerers and similar magic practitioners are proficient enough that they can even figure out a new spell incantation every time they reach a new level of experience. However, there are still a multitude of incantations one can learn. The trick is learning them.

It is far easier to learn an already existing incantation than it is to create one from scratch. This is due, in part, to the knowledge that the existing spell is proven to work. It simply adds to the level of conviction and therefore insures the success of the spell. Remember that spells are designed to focus one's concentration and will so strongly that the mage can create a magic effect. This is more difficult than one might imagine.

Magic Guilds & Brotherhoods

A mage can learn new spells through several different means. The most common, but sometimes compromising, way is to join a **magic guild or brotherhood**. The Seeker and Nocturne Fac-

tions (see the *Factions Section* for details) have enough magicians to qualify as being the equivalent of a brotherhood. Additionally, a number of small sorcerous orders are scattered across the world. Most of them are very secretive and closed to outsiders. This is doubly true now that the Nightlords and their minions are hunting and murdering all other supernatural creatures and magicians. Finding and gaining acceptance into one of these guilds can be an adventure in itself!

The brotherhood will usually teach new invocations to its members, but usually demands total allegiance to it, meaning that the member will donate at least 10% of his annual income to the brotherhood and support it (cleaning, building, maintenance, teaching) and protect it from enemies. The latter may lead to being sent on research, archeological, reconnaissance, and even combat assignments. This could also lead to one's services being rented out to outside forces, such as a criminal organization or wealthy corporation, who need the talents of a mage for whatever reason and are willing to pay the brotherhoods handsomely for it. Rivalry between magic brotherhoods and individuals can also lead to magical gang wars and acts of vengeance.

Initiates to a guild will usually be given a speech about the benefits of membership (there are some real benefits too, such as low room and board, sanctuary from outside forces, access to mystic knowledge and books in general, and communication with fellow mages). Gaining acceptance may be as simple as giving a donation of \$10,000, or as difficult as finding a lost artifact in the frozen reaches of Tibet! Even after acceptance, spell knowledge is likely to be withheld for a few months until he or she has proven to be loyal and worthy. Acts of heroics, dedica-

tion, and generosity (big donations) are likely to dramatically increase one's acceptability and earn the character acceptance and the right to be taught a couple new spells (Level 1-6 are most freely given).

Spell knowledge is power, thus it is guarded jealously by most mages. 21st Century Earth has so little magic knowledge available that in some cases, the holders of such knowledge may not even be aware they have magical power hidden in some ancient leather-bound book or parchment scroll! The easiest spells to find are levels one to four, followed by levels five to seven. Beyond this, the secrets of magic are just that, secret.

Generally, any action that significantly helps the guild will earn the mage the right to be taught 1D4 new spells of his choice (assuming the spells are known by its membership). Spell level is usually kept to magic levels 1-5. An incredible act of heroics or self sacrifice will earn the character 4+1D4 spells selected from levels 1-6, or any one spell from any level beyond six. Non-members who save or protect the guild at great risk to their own lives are offered guild membership and a reward of two spells from levels 1-4 (non-mages will be healed, fed, given a free room for a few weeks, and/or a cash reward or the possibility of being owed a favor by the guild).

Purchasing Magic

On 21st Century Earth, this option is all but unknown. At best, practitioners of magic can occasionally purchase spell magic from a secret guild or order. Even if that remote chance comes true, the prices are usually quite steep. The following prices are rough guidelines and reflect what some secret brotherhoods



might charge a relatively *friendly* outsider (however, those not known or trusted are never taught anything for any price). Along with those prices there will probably be an offer to join the brotherhood, which is both cheaper and more convenient for everyone, unless one is looking for independence and freedom.

Prices: \$5,000 each for level one, \$10,000 each for level two, \$20,000 each for each level three, \$30,000 each for each level four, \$40,000 for each level five, \$70,000 for each level six, \$90,000 for each level seven, \$120,000 for each level eight, \$160,000 for each level nine. Add 10% for offensive spells, add 20% for metamorphosis and summoning spells. Also, not all magic guilds can offer the full range of spells (levels 1-4 are most common) and many will not be able to teach spells at all! Prices will change from place to place and with person to person.

Demons and other supernatural fiends will sometimes teach magic for money or more often, for trade of a particular item, information, or service. However, it is always dangerous when dealing with demons for obvious reasons.

Magic Terms

Level of experience of the spell caster refers to the experience level of the person who is casting the magic. This is a very important distinction, particularly in a combat situation, because the higher the experience level of the spell caster, the more powerful the spell. Many invocations will indicate something like "Duration: 5 melees per level of experience." or "*One die damage per level of the spell caster.*" and so on. **This means** that a *third level mage* with a spell duration of 5 melees per level of the spell caster, upon casting a spell, can maintain the spell's effects for a maximum duration of *15 melees* (5 melees for each level of experience = 15 melees).

Range: Indicates the maximum distance the magic can be cast with: X number of feet, touch, or radius (area of spell effect).

Area affect magic are incantations that affect everyone in a given area or radius. A spell with a 15ft radius affects *all* within the circle of its power/radius. Those just outside the area are not affected.

Line of vision means that the mystic's target/victim must be within his sight (line of vision) to be affected. If the target is not seen, is totally obscured by obstacles, darkness, invisibility, or just not seen by the spell caster (hiding, behind him, beyond normal vision), the magic can not be used. However, some line of vision spells can be directed in a specific area that the spell caster can see to affect someone invisible or hidden.

Touch means that the magic's effects can only be transmitted through physical contact.

Duration: This indicates how long the magic's effects last, whether it be *instant* like a Fire Bolt or *long-lasting* like a Fly as an Eagle spell. Long-lasting magic will indicate exactly how many melees or minutes it lasts, "*per level of experience.*"

Base magic strength/attack for spell magic is 12.

Base magic strength/attack for ritual magic is 16. No bonuses apply to increase the strength of ritual magic.

Spell Descriptions

By Kevin Siembieda & C.J. Carella

An Alphabetical List of Invocations by Level

The numbers in parentheses are the amount of P.P.E. required to use the magic.

Level One

Blinding Flash (1)
Cloud of Smoke (2)
Death Trance (1)
Globe of Daylight (2)
See Aura (2)
See the Invisible (2)
Sense Evil (1)
Sense Magic (2)
Sense Nightbane (3)
Sense P.P.E. (3)
Thunderclap (2)

Level Two

Befuddle (3)
Climb (3)
Concealment (3)
Detect Concealment (4)
Extinguish Fire (4)
Fear (5)
Heavy Breathing (3)
Levitation (4)
Mystic Alarm (4)
Ritual: Call Creature of Light (10)

Level Three

Breathe Without Air (5)
Energy Bolt (5)
Fingers of Wind (5)
Float in Air (5)
Fuel Flame (5)
Ignite Fire (6)
Impervious to Fire (5)
Impression (4)
Invisibility: Simple (6)
Magic Armor (10)
Negate Poisons/Toxins (5)
Ritual: Call Nightlands Denizen (15)
Telekinesis (6)

Level Four

Astral Projection (7)
Charismatic Aura (7)
Cure Minor Disorders (7)
Energy Field (7)
Fire Bolt (7)
Night Vision (6)
Repel Animals (7)
Shadow Meld (7)
Swim as Fish (6)
Trance (7)

Level Five

Calling (8)
Charm Weapon (15)
Circle of Flame (10)
Domination (10)
Energy Disruption (12)
Escape (8)
Eyes of Thoth (8)
Fly (15)
Heal wounds (10)
Horrific Illusion (10)
Midnight Wind (12)
Sleep (10)
Superhuman Strength (10)
Superhuman Speed (10)
Swim as Fish (12)

Level Six

Apparition (20)
Call Lightning (15)
Compulsion (20)
Cure Illness (15)
Fire Ball (10)
Impervious to Energy (20)
Mask of Deceit (15)
Memory Bank (12)
Ritual: Call Nightlord (25)
Teleport: Lesser (15)
Time Slip (20)
Tongues (12)
Words of Truth (15)

Level Seven

Agony (20)
Invisibility: Superior (25)
Life Drain (25)
Metamorphosis: Animal (25)
Paralysis: Superior (25)
Purification (Food/Water) (20)
Ritual: An Eye for An Eye (30)
Second Sight (20)
Wind Rush (20)

Level Eight

Hallucination (30)
Locate (30)
Luck Curse (35)
Metamorphosis: Human (35)
Minor Curse (30)
Negation (30)
Nightlands Portal (50)
Oracle (30)
Sickness (35)
Spoil (Water/Food) (30)
Temporary Enchantment (30)

Level Nine

Curse: Phobia (40)
Familiar Link (55)
Metamorphosis: Insect (60)
Protection Circle: Simple (45)
Summon and Control Canine (50)
Temporary Insanity
Transferral (50)

Level Ten

Banishment (65)
Bind Nightbane (70)
Bonding (80)
Control/Enslave Entity (80)
Curse: Paranoia (70)
Metamorphosis: Superior (100)
Summon/Control Rodents (70)
Summon Nightlands Denizen (75)
Wards (90)

Level Eleven

Control Nightlands Denizen (85)
Create Magic Scroll (160)
Curse: Neurosis (95)
Nightlands Passage (100)
Remove Curse (140)
Summon and Control Animals (125)
Summon Fog (140)
Summon Nightlord Avatar (150)

Level Twelve

Amulet (290)
Calm Storms (200)
Metamorphosis: Mist (200)
Summon Entity (250)
Summon Rain (200)



Level Thirteen

Enchant Weapon (300)
Protection Circle: Superior (250)
Summon Storm (300)
Summon Nightlord (425)
Sanctum (390)
Talisman (500)

Level Fourteen

Close Rift (200)
Id Barrier (600)
Restoration (750)

Level Fifteen

Dimensional Portal (1000)
Teleport: Superior (600)

LEVEL ONE

Blinding Flash

Range: 10 ft (3.0 m) radius; up to 60 ft (18.3 m) away.

Duration: Instant

Saving Throw: Standard

P.P.E.: 1

This invocation creates a sudden burst of intense white light, temporarily blinding everyone in its ten foot (3.0 m) radius. Victims are blinded for one to four (1D4) melee rounds, with a penalty of -5 to strike, and -10 to parry and dodge. The chance of falling is 50% every 10 ft (3.0 m). The magic can be cast up to 60 ft (18.3 m) away. Saving throw is standard; those who successfully save versus magic are not blinded.

Cloud of Smoke

Range: 90 ft (27.4 m)

Duration: 4 melee rounds (1 minute) per level of experience.

Saving Throw: None

P.P.E.: 2

This magic enables the sorcerer to create a cloud of dense, black smoke (30 ft/9.1 m x 30 ft/9.1 m x 30 ft/9.1 m maximum size) up to ninety feet (27.4 m) away. Victims caught in the cloud will be unable to see anything beyond the cloud, and their impaired vision allows them to see no more than three feet (0.9 m) in the cloud (and that means only a blurry shape). While in the cloud, victims will be at -5 to strike, parry and dodge.

Death Trance

Range: Self

Duration: 10 melee rounds (2.5 minutes) per level of experience.

Saving Throw: None

P.P.E.: 1

A magically induced trance which makes the mage appear to be dead. There is no breathing, pulse, heartbeat, or any other signs of life. While in the trance, the sorcerer is quite helpless, unable to speak, move or invoke magic. Only minor physical sensations felt by the mage are recognizable, like being jostled, carried or hearing voices, but no specific identification or memories are possible. The magic can be canceled at will.

Globe of Daylight

Range: Near self or up to 30 ft (9.1 m) away.

Duration: 12 melee rounds (3 minutes) per level of experience.

Saving Throw: None

P.P.E.: 2

A small globe or sphere of true daylight is magically created. The light is bright enough to illuminate a 12 ft (3.65 m) area per each level of its creator's experience. Because it is daylight, it can ward off most vampires, keeping them at bay just beyond the edge of light. The creator of the globe can mentally move it along with himself, or send it up to 30 feet (9.1 m) ahead. The maximum speed at which the globe can travel is equal to a speed attribute of 12.

See Aura

Range: 100 ft (30.5 m)

Duration: 1 melee round.

Saving Throw: None, but a psychic mind block will mask the presence of psychic abilities, the level of P.P.E. and possession.

P.P.E.: 6

All things, organic and inorganic, have an aura. The aura has many distinctions, and can be used to see or sense things invisible to the eye. *Seeing an aura will indicate the following:*

- Estimate the general level of experience. Low (1-3), medium (4-7), high (8th and up).
- The presence of magic (no indication of what, or power levels).
- The presence of psychic abilities.
- High or low base P.P.E.
- The presence of a possessing entity.
- The presence of an unusual human aberration, which indicates a serious illness, non-human, or alien, but does not specify which.

Note: Cannot tell one's alignment from this spell.

See the Invisible

Range: 200 ft (61.0 m)

Duration: 1 minute (4 melees) per level of experience.

Saving Throw: None

P.P.E.: 4

The character can see forces, objects and creatures which can turn invisible or are naturally invisible. Even if the creature has no form per se, the mystic will be able to discern the vaporous image or energy sphere which is the being. This includes ghosts, entities and astral bodies.

Sense Evil

Range: 90 ft (27.4 m) area.

Duration: 2 minutes (8 melees) per level of experience.

Saving Throw: None, except a psychic mind block, or a protection from a magic pentacle which will prevent the spell from working on anyone in the circle. The psychic's equivalent power of sense evil is not blocked by the magic pentacle.

P.P.E.: 2

The sense evil invocation will enable its spell caster to feel or sense the presence of *supernatural evil*. It will indicate how many supernatural evil presences are within the 90 foot (27.4 m) area; one, a few (2-6), several (7-14), or many (15 or more). It can also register the intensity of the evil and pinpoint the general location of the source(s) to a particular room(s), possessed object, person, or an approximate distance (very close, near, far, etc.).

Evil emanations from human beings are much less distinct and cannot be sensed unless the source/person has an immediate evil intention. Nightbane and other supernatural beings who are not necessarily evil are only detected if their alignment is diabolic or miscreant, or if they harbor evil intentions towards the caster.

Sense Magic

Range: 120 ft (36.5 m) area.

Duration: 2 minutes (8 melees) per level of experience.

Saving Throw: None

P.P.E.: 4

This magic ability enables the character to sense or feel the presence of magic. Like a Geiger counter, the individual can tell if he is near (within 20 ft/6.1 m) or far (toward the limit of the range). The ability can also indicate whether a person or object is enchanted/under a magic spell (this does not include psychic powers or Nightbane talents), is in the process of invoking magic, or if magic is being used in the range area. **Note:** Men of magic and most supernatural beings do not register as magic except when actually casting a spell/using magic.

Sense Nightbane

Range: 200 ft (61.0 m) area.

Duration: 1 minute (4 melees) per level of experience.

Saving Throw: None

P.P.E.: 3

This invocation works like the natural Nightbane ability to sense others of their kind, enabling the sorcerer to sense the presence of Nightbane within the area. The ability does not tell the exact location or numbers of Nightbane, but will reveal whether there is more than one, and roughly how far way they are (within 30 ft/9.1 m).

Sense P.P.E.

Range: 120 ft (36.5 m) area.

Duration: 1 minute (4 melees) per level of experience.

Saving Throw: Standard; ley lines and inanimate objects have no saving throw.

P.P.E.: 3

This invocation allows the sorcerer to sense the presence of potential psychic energy (P.P.E.). Like a Geiger counter, the individual can tell if he is near (within 20 ft/6.1 m) or far (at the limit of the magic's range). This magic ability should not be confused with "sense magic." It cannot pick up magic emanations, so it will not identify most magic objects, enchantments or spell casting. What this magic does provide is an indication of potential psychic energy within the area — people, places, supernatural beings, animals and other sources of P.P.E. This can be important if there is a need to draw additional P.P.E. from another source(s). **First**, the magic will alert the sorcerer to the presence of potential psychic energy in its range area. **Second**, the arcanist can determine the approximate amount of P.P.E. each individual currently possesses. Little is 1-5 P.P.E., typical is 6-15, medium is 16-30, a lot is 31-60, vast (and often unnatural) is 61 and higher, incredible is 500 P.P.E. and higher. Objects only register potential psychic energy if they are possessed/inhabited by a living force.

Thunderclap

Range: Directly affects the immediate area (30 ft/9.1 m around the sorcerer), but can be heard up to one mile (1.6 km) away.

Duration: Instant

Saving Throw: Save vs Horror Factor.

P.P.E.: 4

The invocation produces a booming clap of thunders so loud that it seems to make the air vibrate. A thunderclap is an excellent means of alerting or signaling allies, as well as a means of intimidation. As an intimidation device, it will momentarily startle and distract everyone other than the spell caster. This provides the creator of the thunder with a bonus of +5 on his initiative, +1 to strike, parry and dodge, and creates a horror factor of 8 (all characters within 30 ft/9.1 m) must roll to save vs. horror factor, except the mage who made the thunder.

LEVEL TWO

Befuddle

Range: 100 ft (30.5 m)

Duration: 2 minutes (8 melees) per level of experience.

Saving Throw: Standard.

P.P.E.: 6

An enchantment that temporarily causes its victim to become confused and disoriented. Concentration and reactions are impaired. Those affected are -2 to strike, parry and dodge; attacks per melee are reduced by one half and all skills suffer a penalty of -20%. Each invocation affects only one person each time it is cast. A successful save vs magic means the intended victim suffers no impairment.

Climb

Range: Self, or others up to 40 ft away (12.2 m).

Duration: 5 minutes (20 melees) per level of experience.

Saving Throw: None

P.P.E.: 3

An enchantment that enables the enchanted person to climb with exceptional, almost inhuman, skill, speed, and agility. Skill level is 98% for normal, rough, climbable surfaces; speed is equal to the speed attribute. Smooth, presumably unclimbable or extremely difficult surfaces to climb normally can be scaled with a skill level of 60%. Rappelling is included.

Concealment

Range: Small objects up to 40 ft away (12.2 m).

Duration: 5 minutes per level of experience.

Saving Throw: Standard

P.P.E.: 6

This magic makes any small object sort of invisible. Actually, it affects the perception of anybody who looks at it. Unless the person(s) makes a successful saving throw, the item cannot be seen. This can be applied to one item on one's person or out in the open. Only one object is affected each time the magic is invoked. The object cannot be living and must be smaller than 14 inches (0.35 m) in length and height, 6 inches (0.15 m) in width,

and weigh 14 pounds (6.4 kg) or less. Each person who looks at the place where the enchanted object is resting must roll a saving throw versus magic. A failed roll means that particular individual will not see it until the magic lapses. **Note:** If the object is used as a weapon or picked up by the mage or anyone who does see it, the enchantment is broken and it becomes clearly visible to all.

Detect Concealment

Range: Area affected: 30 ft (9.1 m).

Duration: Instant

Saving Throw: None

P.P.E.: 6

A magic invocation that will instantly negate any concealment spells and reveal any objects which may have been mystically concealed. Can be directed at a specific area or individual, or made to affect an entire area of up to 30 ft/9.1 m.

Extinguish Fire

Range: 20 foot (6.1 m) area, up to 80 ft (24.4 m) away.

Duration: 1 minute (4 melees) per level of experience.

Saving Throw: None

P.P.E.: 4

The sorcerer can instantly put out up to a 20 foot (6.1 m) area of fire 80 ft (24.4 m) away. A total of 40 ft (12.2 m) can be extinguished every melee round.

Fear (Horror Factor: 16)

Range: 20 foot (6.1 m) area, up to 100 feet (30.5 m) away.

Duration: 1 minute (4 melees) per level of experience.

Saving Throw: Special; Save vs Horror Factor.

P.P.E.: 5

The invocation creates a sensation of fear over a particular area (20 ft/6.1 m maximum area of effect). The mystic can place the enchantment on an area occupied with people, or an area that is not presently occupied. Anybody entering the area of enchantment must roll to save vs horror factor 16. A failed roll means the person is suddenly washed with terror and will be momentarily stunned, lose initiative, and will be the last person to attack and will not be able to defend himself against an opponent's first strike each melee the person is in the area of fear. Also see the Horror Factor explanation in the combat section of this book.

Heavy Breathing

Range: 60 ft (18.3 m) away

Duration: 5 melees per level of experience.

Saving Throw: Standard

P.P.E.: 5

The sorcerer is able to conjure a mysterious, frightful sound of heavy, labored breathing, as if something invisible is lurking about. The mage can mentally manipulate the sound, increasing or decreasing the breathing rhythm, and move the sound around up to 60 ft (18.3 m) away. The breathing can be heard in a six foot (1.8 m) radius. Those hearing the breathing will become fearful and panicky. There is a 60% chance that the frightened fellow will flee in terror. Those who hear the breathing, but do

not run, will be -2 to strike, and -1 to parry and dodge as they shake in their boots.

Saving Throw: Standard; those who save are not affected/fearful.

Levitation

Range: Up to 60 ft (18.3 m) away.

Duration: 3 minutes per level of experience.

Saving Throw: Standard

P.P.E.: 5

Magic levitation enables the invoker of the magic to raise himself, or other people, or an object, straight up into the air and suspend it there (hover). Movement is limited to straight up and down; no horizontal motion is possible. Weight is restricted to 200 lbs (90 kg) plus 20 lbs (9 kg) per level of experience. Unwilling victims of the magic get a saving throw; a successful roll means the person is not affected by the levitation and remains planted firmly on the ground. Maximum height possible is 60 ft (18.3 m) plus 10 ft (3.0 m) per level of experience. Targets can be affected up to 60 ft (18.3 m) away.

Mystic Alarm

Range: 12 ft (3.65 m) (one object).

Duration: One year per level of experience.

Saving Throw: None

P.P.E.: 5

The sorcerer can protect his possessions and domicile by placing mystic alarms on them. The invocation creates invisible, ward-like symbols on any one, specific, non-living object. If this object is touched or disturbed by anyone other than the spell caster, a silent alarm will alert him instantly, even if he is thousands of miles away or in another dimension. Once disturbed, the alarms disappear. The mystic alarm has a limited life of one year per level of the sorcerer.

Ritual: Call Creature of Light

Casting Time Required: Fifteen minutes

Range: 10 miles (16 km) per level of the caster

Duration: Instant

Saving Throw: None

P.P.E.: 10

This ritual invocation contacts the nearest creature of light in the area. The Guardians are just one such group; more of these mysterious beings will be described in future Nightbane sourcebooks. The creature of light will sense that his/her presence is required by the spell caster and the ritual will also impart an empathic flash of the summoner's personality and intentions. This means that an evil sorcerer trying to ambush the creature of light will be automatically unmasked by the invocation. Whether or not any creatures of light are nearby, or willing to help, is up to the Game Master.

LEVEL THREE

Breathe Without Air

Range: Self or others by touch.

Duration: 12 melees (3 minutes) per level of experience.

Saving Throw: None

P.P.E.: 5

This invocation enables the person to function normally without air, whether it be underwater or in a vacuum, or in an area with little or no oxygen. Unfortunately, the magic does not protect the person from magic toxins or other types of magic, but does protect against natural and man-made gases.

Energy Bolt

Range: 150 ft (45.7 m)

Duration: Instant

Saving Throw: Dodge of 18 or higher.

P.P.E.: 5

The incantation creates an energy bolt that the mage can mentally direct by simply looking at his intended target. The bolt may appear to fire from a hand or finger or the eyes, but needs no physical gesture, such as pointing. Damage is normally 4D6, but is increased to 6D6 under the influence of a ley line and 8D6 at a ley line nexus. P.P.E. cost is still only five despite the increased damage capability. One energy bolt can be fired at one target per each spell invocation.

Fingers of Wind

Range: 90 ft (27.4 m)

Duration: 3 melees per level of experience.

Saving Throw: None

P.P.E.: 5

The magician can conjure a wind and manipulate it to touch, tap, bump or press against a person or object. It can also put out candles, slam doors, shut, or move or knock over small items weighing less than 10 lbs (4.5 kg).

Float in Air

Range: Self or others within 30 ft (9.1 m)

Duration: 10 melees per level of experience

Saving Throw: None.

P.P.E.: 5

This spell creates air currents which hold a person or object aloft, hovering about one foot (0.3 m) above the ground. It can be used to slow someone's descent from a fall or used to float on top of water. Movement is awkward and slow while in the air. The floating person suffers the following penalties: all attacks, strikes, parries and dodges are at -1; normal speed/movement is reduced by half.

Fuel Flame

Range: 100 ft (30.5 m)

Duration: Instant

Saving Throw: None

P.P.E.: 5

The magic feeds any existing fire, doubling it in size. It can affect a flame from 10 ft (3.0 m) up to 100 ft (30.5 m) away.

Ignite Fire

Range: 40 ft (12.2 m)

Duration: Instant (fire lasts until it is put out).

Saving Throw: None

P.P.E.: 6

A magic that causes spontaneous combustion. The magic will ignite any material that can burn. This means the mystic could set on fire a chair, a jacket, hair, and so on. Note: Volatile substances inside a container, like gasoline in the gas tank of a car, cannot be ignited. The target to be set on fire must be clearly visible. Maximum area of effect is 3 ft (0.9 m). If somebody's clothes or hair are set on fire, they have two melees (30 seconds) to get it off or put the fire out before damage is inflicted; no other combat or action is possible. Damage from the small fire is 2D6 S.D.C. per melee (beginning after the first 2 rounds).

Impervious to Fire

Range: Self or others up to 60 ft (18.3 m) away.

Duration: 5 minutes per level of experience.

Saving Throw: None

P.P.E.: 5

A magic invocation that makes the individual temporarily impervious to fire. Normal and magical fires do no damage to the person or to anything he is wearing/on his person.

Impression

Range: Touch

Duration: One melee (15 seconds).

Saving Throw: None.

P.P.E.: 5

The sorcerer is magically instilled with the ability to receive psychic impressions from an object about its previous owner. The following information will be revealed.

1. General alignment; good, selfish, or evil.
2. Human or not human (specific nature of the inhumanness is not revealed).
3. Old or young.
4. Male or female.
5. Healthy, sick or hurt.
6. Whether the object is important or valuable to the individual, although the reason is not revealed.

Invisibility: Simple

Range: Self only (includes clothes and articles on one's person).

Duration: 3 minutes per level of experience.

Saving Throw: None

P.P.E.: 6

The spell caster and anything he is wearing or carrying at the time of the invocation are turned completely invisible. Any object picked up after the character has become invisible remains visible. Likewise, any item on his person that is dropped becomes visible. Neither normal nor nightvision can detect invisibility; only beings who can naturally, psychically or magically "see the invisible" are able to see the spell caster. Infrared and heat detectors can also pinpoint an invisible person.

Although the invisible person is imperceptible to the eye, he still retains physical mass. This means that he cannot go through walls nor can weapons pass harmlessly through him. The character still makes noise, leaves footprints, and physical magical contacts/attacks still affect him as usual. At the game master's option, an attacker who makes a difficult Perception roll can try to attack the invisible character (this requires a *called shot* at -2 to strike).

While invisible, the mage can talk, weave spells, walk, climb, run, open doors, carry objects and perform other acts of physical exertion, including combat. The invisibility is terminated when the magic's duration time elapses or the mage cancels the spell. **Note:** If cut, only the blood is visible.

Magic Armor

Range: Self or other.

Duration: 4 melees (1 minute) per level of the spell caster

Saving Throw: None.

P.P.E.: 10

This powerful spell instantly creates an invisible, weightless, noiseless, full suit of mystic armor upon the spell caster (or other). This mystic armor has an A.R. of 14 and an S.D.C. of 100 plus 10 per level of the caster; fire, lightning and cold do one-half damage.

Negate Poisons/Toxins

Range: Self or by touch.

Duration: Instant

Saving Throw: None

P.P.E.: 5

The sorcerer can magically turn a poisonous substance inert, rendering it harmless. The magic can also be used to instantly negate poison in the bloodstream of a person, preventing further damage by the foul substance. However, any damage caused by the poison before the magic is used cannot be reversed.

Ritual: Call Nightlands Denizen

Casting Time Required: One hour.

Range: 20 ft (6.1 m) per level of experience.

Duration: Instant

Saving Throw: None

P.P.E.: 15

This ritual requires a mirror or other reflective surface. At the completion of the ritual, the mirror will turn black and open into the Nightlands, calling the nearest Nightland denizen in the area (this includes Droggangers, Hounds, Hunters, Ashmedai and Nemtar, but not Nightbane and Nightlords). The creature may or may not answer the call, or use the breach in the Mirrorwall to cross over and cause mischief, so typically this ritual is con-

ducted when and where the sorcerer is ready to deal with a hostile Nightlands monster. **Note:** This ritual will automatically awaken a Doppelganger.

Telekinesis

Range: 60 ft (18.3 m)

Duration: 1 minute per level of experience.

Saving Throw: Dodge

P.P.E.: 8

The telekinesis invocation temporarily empowers the spell caster with the psychic ability to move objects with thought. This power can be used to move or hurl objects, bring them to him, open doors, flick switches, press buttons, and so on.

Rules and Limitations:

- **Maximum Total Weight:** 60 pounds (27 kg)
- **Attacks Per Melee:** Equal to the number of hand to hand attacks per melee that the character may have.
- **Bonuses to Strike:** +3 with telekinesis; physical and skill bonuses to strike do not apply when telekinesis is used.
- **Bonuses to Parry:** +4; physical and skill bonuses do not apply to telekinesis.
- **Damage from Hurled Objects:**
 - Small: 6 ounces (0.2 kg) to 1 lb (0.45 kg) — 1D4
 - Small: 1.5 to 2.5 lbs (0.7 to 1.1 kg) — 1D6
 - Medium: 3 to 4.5 lbs (1.4 to 2.0 kg) — 2D4
 - Medium: 5 to 10 lbs (2.25 to 4.5 kg) — 3D4
 - Large: 11 to 25 lbs (5 to 11.3 kg) — 3D6
 - Large & Heavy: 26 to 60 lbs (11.7 to 27 kg) — 4D6Add 1D6 for each additional 20 lbs (9 kg) of weight.
- Object being manipulated must be visible.
- Telekinesis can be combined with hand to hand combat, but does not add extra attacks per melee.
- Influence from ley line energy doubles the amount of weight and range possible.
- Ley line nexus energy triples the amount of weight and range.

LEVEL FOUR

Astral Projection

Range: Self

Duration: 5 minutes per level of experience.

Saving Throw: None

P.P.E.: 7

The incantation sends the spell caster's astral body into the astral plane, dimension. This magic functions exactly like the psychic sensitive ability of the same name.

Charismatic Aura

Range: 60 foot radius (18.3 m)

Duration: 6 melee rounds per level of experience.

Saving Throw: Standard

P.P.E.: 7

A particularly handsome tool of deception, this magic can be cast upon the spell caster or another person. The spell instantly enhances the person's physical beauty by eight, increasing his

charisma so he can charm all who behold him. Although the focal point of the spell is the person on whom it was cast, it affects everybody in a 60 foot (18.3 m) radius (emanating from the person with the charismatic aura). Thus, everybody in that radius is allowed a saving throw vs magic. Those who successfully save will not be affected at all; those who fail to save are affected and will respond accordingly.

The person with a charismatic aura can invoke one of three responses: friendship/trust, power/fear, and successful deception.

Friendship/Trust: The first few words spoken will set up the response. This is a statement of friendship, peace or trust which will inspire those sentiments in everyone affected.

Power/Fear: A statement of power, anger, strength, or vile intent, will strike awe and fear into everyone affected. (Example: "Lay down your weapons and let us pass, lest you suffer my wrath!"). **Horror Factor:** 13.

Successful Deception: this enables the charismatic aura person to convincingly lie like a master con-man. There is an 80% chance that those affected will believe anything he tells them. This response is triggered by a phrase like, "Trust me completely...." or "I would never lie to you."

Cure Minor Disorders

Range: Touch or 10 ft (3 m).

Duration: Instant

Saving Throw: None

P.P.E.: 7

A unique bit of curative magic that will instantly relieve minor physical disorders and illness, such as headaches, indigestion, gas, heartburn, nausea, hiccups, muscle stiffness, low fever (under 101 degrees) and similar. This invocation will also negate simple curses that inflict minor disorders.

Energy Field

Range: Self or others up to a 60 ft (18.3 m) distance.

Duration: One minute per level of experience.

Saving Throw: None

P.P.E.: 7

The magic creates a protective field of energy around the mystic, others, or an object. The maximum area of protection is about 8 ft (2.4 m), which means it can protect a small roomful of people (about 6 to 8 individuals). The energy field appears as a semitransparent wall or bubble that shimmers with a blue-white light. The field normally provides a total protection of 60 S.D.C., but is doubled at ley lines and tripled at ley line nexuses.

Fire Bolt

Range: 100 ft (30.5 m) plus 5 ft (1.5 m) per level of experience.

Duration: Instant

Saving Throw: Dodge

P.P.E.: 7

Like the energy bolt, the sorcerer can create and direct a bolt of fire. Bonus to strike is +4. Damage is normally 6D6, but increases to 8D6 at ley lines and to 1D6x10 at a ley line nexus.

Nightvision

Range: Self or others by touch.

Duration: 5 minutes per level of experience.

Saving Throw: None

P.P.E.: 6

This invocation gives the character the power to see in absolute darkness; range of the vision: 200 ft (61 m) plus 100 feet (30.5 m) per level of experience.

Repel Animals

Range: 30 ft (9.1 m)

Duration: Instant

Saving Throw: Standard for animals.

P.P.E.: 7

An enchantment that will make even a hostile predatory animal stop, turn, and leave the area without harming the mage or anybody near him. The animal will not return for hours. The enchantment can affect six animals simultaneously.

Shadow Meld

Range: Self

Duration: Two minutes per level of experience.

Saving Throw: None.

P.P.E.: 7

This unique magic enables the mage to step into shadows, becoming totally invisible, even to a “see the invisible” spell. The shadow must be at least five feet (1.5 m) tall to become an effective hiding place. The shadow serves as a superior means of hiding or moving unseen. The mage can move, walk, or run throughout the length of shadows or from shadow to shadow. While in shadow/darkness, the mage prowls at 60% proficiency (or at +15% to normal skill, whichever is higher).

Intense light will dispel the shadow, leaving the mage revealed. Of course, sanctuary can be found by fleeing into another shadow. Feeble light, less than 10 torches or 300 watts, will only create more shadows.

While hidden in shadows, the character is still susceptible to magic, psychic and physical attacks, although attackers are at -5 to strike him (because they cannot see him). Area effect magic does not suffer any penalty. Infrared optics are the only means that can be used to see somebody in a shadow.

Swim as Fish (minor)

Range: Self or others up to 10 ft (3.0 m) away.

Duration: 5 minutes per level of experience.

Saving Throw: None.

P.P.E.: 6

An incantation that provides the character with exceptional swimming abilities. Equal to Advanced Swimming and S.C.U.B.A. skills combined. Base skill is 96%, can swim a distance of 100 x P.S. in yards/meters without tiring, the caster has an additional +1 to parry and dodge while in water, and can hold his/her breath for two minutes at a time.

Trance

Range: Touch of within 12 ft (3.65 m).

Duration: 5 minutes per level of experience.

Saving Throw: Standard.

P.P.E.: 7

This enchantment places another person into a zombie-like state in which the entranced person is in a hypnotic daze, unaware of his environment or the happenings around him. He cannot formulate thoughts, use skills, or act on his own. While entranced, the individual is only aware of the enchanter’s voice and will follow extremely simple commands, such as stay, sit, follow me, get inside, lay down, give me your hand, etc. The entranced victim cannot engage in any type of combat, nor any actions that require skill or thought, and offers no resistance. The magic is meant to incapacitate more than it is to enslave. Evil sorcerers often use trance on prisoners or on the intended victims of a human sacrifice.

While entranced, the person cannot be made to reveal secrets, betray a friend, harm himself, or act against his alignment. All physical attributes function as if they are half of what they really are, thus, a speed of 10 is 5 while entranced. The victim of a trance will remember nothing of the events that occurred while entranced. Cannot affect people inside vehicles.

LEVEL FIVE

Calling

Range: 2 miles (3.2 km) per level of experience.

Duration: 5 minutes per level of experience.

Saving Throw: Standard.

P.P.E.: 8

The calling is like a limited form of telepathic communication in which the sorcerer can mentally call a specific individual. To use “the call,” the mystic must know the person’s whole name (first and last), must have personally met the individual (even if only briefly) and must be within range. The call sends a telepathic message to that particular person, calling him or her by full name, and leaves an impression of where the mage can be found. A typical call message will be something like “Richard Burke, I need you.” Only the individual to whom the call is made can hear it. If a successful saving throw is made, the call, and impression of location, is heard only once. If the saving throw is not successful, the call will repeat itself over and over again, three times per melee, until the spell elapses or the person goes to the mage. Nothing except a mind block can stop the call.

Charm Weapon (Ritual)

Casting Time Required: 1 hour

Range: Touch

Duration: 12 hours per level of the spell caster.

Saving Throw: Standard

P.P.E.: 12

This invocation temporarily enchants a weapon, to make it more effective against supernatural beings. The weapon will inflict double damage to any supernatural creature, or normal dam-

age to beings who cannot normally be harmed by most weapons (like vampires or entities). For example, a sword that normally inflicts 1D8 damage will do 2D8 against Nightspawn or other supernatural beings, and 1D8 against vampires! This ritual will affect both hand to hand and missile weapons; if a missile weapon is thus enchanted, any missiles (bullets or arrows, for example) it fires will be automatically charmed.

Saving Throw: The weapon to be charmed has a saving throw, with a bonus of +1 if it is a missile weapon, or +3 if it is a high-tech weapon (a gun, for example).

Circle of Flame

Range: 10 ft (3.0 m) around the caster.

Duration: 2 minutes per level of experience.

Saving Throw: None.

P.P.E.: 10

The mystic can create a circle of flame around himself. No combustible material is required. The flame is five feet (1.5 m) tall and inflicts 6D6 S.D.C. damage to anybody who tries to pass through the fire.

Domination

Range: Touch or within 4 ft (1.2 m).

Duration: 15 minutes per level of experience.

Saving Throw: Standard

P.P.E.: 10

Domination is another trance-like enchantment that enables the mystic to impose his will over his victim's, forcing the person to do his bidding. The victim of domination will appear to be acting oddly dazed, confused, slow and unfriendly (ignoring friends, etc.). the enchanted person has one goal, to fulfill the command of the mage. Under the enchantment of domination, the character's alignment does not apply. He will steal, lie, assist in crimes, kidnap, betray friends, reveal secrets and so on. The victim is under (almost) complete control of the spell caster. The only things the bewitched character will not do are commit suicide, inflict self-harm, or kill a friend or loved one. A good aligned character, principled, scrupulous, and even unprincipled, cannot be made to kill anybody; it is too deeply against their alignment.

The enchanted person is not himself and suffers the following penalties. Attacks per melee, skills and speed are all halved, speech is slow, and the person seems distracted or a little dazed.

A successful saving throw versus magic means the magic has no effect. The person is 100% his normal self. The effects of the domination magic cannot be faked.

Energy Disruption

Range: 60 ft (18.3 m)

Duration: 3 minutes (12 melees) per level of experience.

Saving Throw: None

P.P.E.: 12

A particularly useful magic in a tech environment. The invocation will temporarily knock-out, stop, or immobilize, any electrical device it is aimed at. This includes normal automobiles, computers, radios, surveillance cameras, sensors, appliances, entire fuse boxes, batteries, electric alarm systems, etc. The appara-

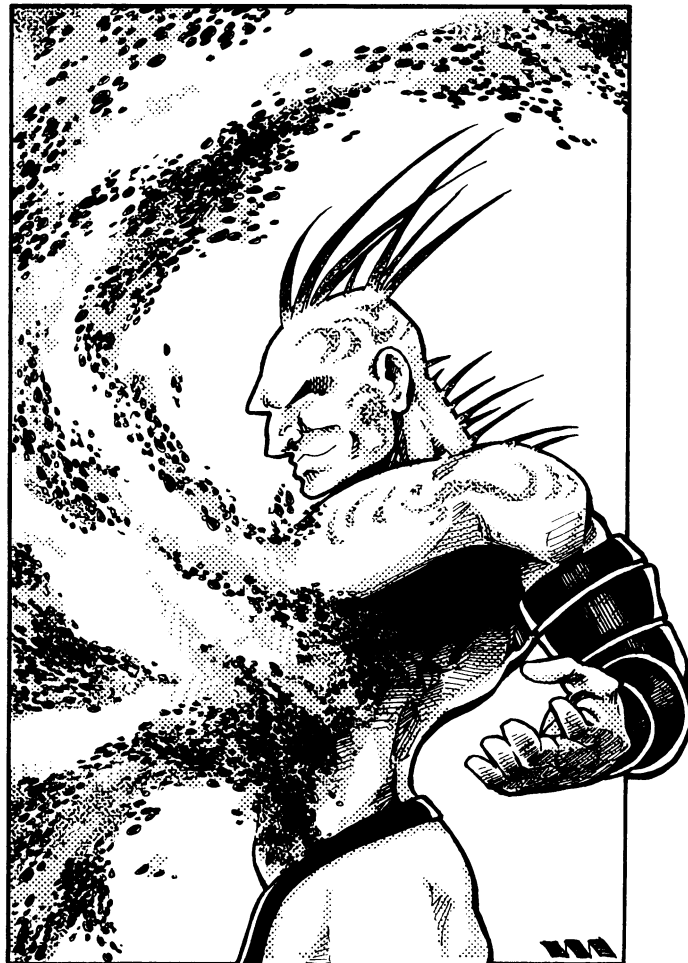

tus is not harmed in any way, it simply ceases to function. When the magic elapses, the item(s) will work perfectly, with no sign of malfunction or energy loss.

Escape

Range: Self, touch, or within 5 ft (1.5 m).

Duration: Instant

Saving Throw: None

P.P.E.: 8

The escape invocation enables the sorcerer to magically escape any bonds, or open any locking mechanism that bars his way. This includes being tied with rope, handcuffs, prison cells, doors, trunks, locks, strait jackets, etc. One restraint or lock can be undone per each invocation (one per melee is possible). Only gagging the mage will prevent the use of this magic.

Eyes of Thoth

Range: Self or others by touch.

Duration: 10 minutes per level of experience.

Saving Throw: None

P.P.E.: 8

Thoth is the god of knowledge and wisdom of the ancient Egyptians and is said to know all languages. This invocation enables the character to read and understand ALL written languages, modern and ancient. However, the spoken languages are incomprehensible unless a tongues spell is also invoked or the person has an education in that language.

Fly

Range: Object or by touch.

Duration: 6 minutes per level of experience.

Saving Throw: None

P.P.E.: 15

The sorcerer can magically bestow the power of flight only to an inanimate object not made of metal or plastic. He or she can then use the object to fly. This is the origin of the myths about the witch and her broom and flying carpets. The object must be big enough to hold onto or, preferably, large enough to sit on. If the item is small, the mage must hold on for dear life, and if his grip should give way, he will fall to his doom. To avoid muscle strain, it is best that the object can be comfortably sat upon. The maximum length and width of the enchanted object must not exceed six feet (1.8 m). This is enough to accommodate three additional adult passengers or six children. **Note:** The magic will not work if the object has any metal or plastic on it, including nails.

Maximum altitude is 1000 ft (305 m). Maximum speed is 35 mph (56 km); the object can be made to hover in a stationary position.

Heal Wounds

Range: Touch or 3 ft (0.9 m) per level of experience.

Duration: Instant

Saving Throw: Standard, if the person resists the magic.

P.P.E.: 10

This powerful invocation will heal physical wounds, such as bruises, cuts, gashes, bullet wounds, burned flesh and pulled muscles. It will not help against illness, internal damage to organs or nerves, broken bones or poisons/drugs.

In the case of bullet wounds, the bullet should be removed first. If the bullet is left inside a person, it will be a constant irritant causing chronic pain; reduce the character's P.E. and P.P. attributes by one each due to stiffness and discomfort.

The heal wound magic restores 3D6 S.D.C. and 1D6 Hit Points.

Horrific Illusion

Range: 30 ft (9.1 m)

Duration: 2 minutes per level of experience.

Saving Throw: Save vs Horror Factor 14.

P.P.E.: 10

The sorcerer creates a frightening, illusionary image of a horrible sight using common images, such as a hundred large (presumably poisonous) spiders or other bugs or snakes, or a vicious, rabid animal(s), or fire, and similar. Everybody who sees the illusion must roll to save vs horror factor: 14. A failed roll means that the character is momentarily stunned, with the usual horror factor combat penalties applicable to that one melee. However, the illusion is so real that any character who fails to save will not go past the illusion, but can try to find another route around it.

Midnight Wind

Range: 150 ft (45.7 m) area.

Duration: One melee round per level of experience.

Saving Throw: Dodge

P.P.E.: 12

This incantation creates a cold, hurricane-force wind and also temporarily darkens the sky in the area. Lights will dim and the temperature will drop 15 degrees Fahrenheit in the area affected. Once per melee round, the spell caster can unleash a powerful gust of wind against one target (+3 to strike), inflicting 3D6 points of damage. If the damage is greater than half the P.S. of the target, the victim is also knocked down by the freezing blast of wind.

Sleep

Range: Touch or 1 ft (0.3 m).

Duration: Becomes inert within 15 minutes; effect lasts 10 minutes per level of experience.

Saving Throw: Standard

P.P.E.: 10

The invocation can turn any normal, drinkable fluid or food into a sleep-inducing potion. Immediately after two bites of enchanted food or two gulps of fluid, the person will fall into an enchanted sleep. The victim cannot be awakened by any means except by the mage canceling the magic or until the spell's duration time lapses. A successful save means the enchanted food or drink has no effect.

Superhuman Strength

Range: Self or others by touch.

Duration: 2 melees per level of experience.

Saving Throw: None

P.P.E.: 10

The incantation magically increases the character's physical strength (P.S.) to 30, physical endurance (P.E.) to 24 and adds 30 S.D.C. for the duration of the magic. This enhanced strength is supernatural (see the **Supernatural Strength Damage Table**).

Superhuman Speed

Range: Self or others by touch.

Duration: 1 minute per level of experience.

Saving Throw: None

P.P.E.: 10

The invocation bestows the character with the incredible speed attribute of 44 (equal to 30 mph/48 kmph) and adds a bonus of +2 to parry and +6 to dodge for the duration of the magic. All movements performed during this period are done without fatigue.

Swim as Fish (superior)

Range: Self or others.

Duration: 10 minutes per level of experience.

Saving Throw: None.

P.P.E.: 12

This spell can be cast on oneself or on one or two people at a time by speaking the incantation and touching the intended targets. The enchanted persons are then able to breathe underwater and swim expertly (at a speed of 20). Base skill 98%. No distance or fatigue factor; swims with ease for the full duration of the spell. Bonus of +2 to parry and dodge while in water.

LEVEL SIX

Apparition

Range: 30 ft (9.1 m)

Duration: One minute per level of experience.

Saving Throw: Standard

P.P.E.: 20

The magician can create a realistic apparition in the form of a horrible creature or weird thing that will attack anybody who comes within 20 ft (6.1 m) of it. Apparitions are commonly used to block passages and guard entrances. Although an illusion, it will appear completely real, interacting with an opponent's actions. The illusion will appear to sweat and bleed, but cannot be killed or stopped. The illusion can appear as any known supernatural creature or imaginary "thing," like a man-eating refrigerator, and so on.

There are only three ways to destroy the illusion: 1) A successful save vs magic will cause the thing to disappear (at least for that individual). Each character must make a saving throw. 2) Plunge a rod or something made of iron into it. 3) Wait for the magic's duration time to elapse.

The person who sees the apparition will believe it to be real in every way and will even imagine it inflicting damage to him. Combat should be conducted as usual, although the damage is imaginary and disappears when the apparition is destroyed. Should the opponent of the apparition die (or so he believes), he will fall unconscious.

Call Lightning

Range: 300 ft (91 m)

Duration: Instant

Saving Throw: None

P.P.E.: 15

The spell creates a lightning bolt which can be directed at any specific target up to 300 ft (91.4 m) away. The lightning bolt shoots down from the sky, hitting the desired target. The target or area must be within the spell caster's line of vision. The lightning bolt does 3D6+6 plus 1D6 damage per level of the caster.

Compulsion

Range: 60 ft (18.3 m); must be within line of vision.

Duration: 24 hours.

Saving Throw: Standard

P.P.E.: 20

The spell caster can implant a sudden desire or need in another person's mind. The focus of the irresistible impulse should be something reasonable and attainable, although the motive may seem quite irrational. The enchanted person will be consumed with the object or action of the implanted compulsion, whether it be something very simple, like a craving for a candy bar, or the need to visit somebody or something more extravagant. The victim will be obsessed with attaining whatever it is for the full duration time of the incantation or until it is attained. A remove curse spell will also negate the compulsion.

Cure Illness

Range: Touch or 3 ft (0.9 m).

Duration: Instant

Saving Throw: None; standard if the person resists treatment.

P.P.E.: 15

A potent magic that can cure ordinary disease and illness, such as fever, flu and other common diseases. The magic cannot cure cancer, lung disease, wounds, broken bones or internal damage to organs. Nor can it cure magically induced sicknesses or disorders.

Fire Ball

Range: 90 ft (27.4 m)

Duration: Instant

Saving Throw: Dodge

P.P.E.: 10

The spell caster creates a large fire ball which hurls at its target at an awesome speed, inflicting 5D6 plus 1D6 damage per level of the caster. The fire ball is magically directed and seldom misses.

Saving Throw: None except dodge, but the victim must know the attack is coming and must roll an 18 or higher.

Impervious to Energy

Range: Self or others by ritual.

Duration: 2 minutes per level of experience.

Saving Throw: None

P.P.E.: 20

The sorcerer can make himself impervious to all forms of energy including fire, heat, electricity, lasers and so on. Energy attacks do no damage whatsoever. Physical attacks, guns, knives, clubs, etc. do normal damage.

Mask of Deceit

Range: Self

Duration: 10 minutes per level of experience.

Saving Throw: Standard.

P.P.E.: 15

A useful tool for deception, it magically creates an illusionary mask over the person's own facial gestures. Age, gender, skin color, hair, hair length and specific features are composed with thought. However, the magic is limited to facial features and does not apply to any other part of the body. The mage can attempt to imitate a specific person's face, but has a mere 20% +5% per level of experience skill level; if the character has the disguise skill, use that base skill instead.

Saving Throw: Everyone encountering the person gets a save vs magic, but is at -4 to succeed. A successful save means the true features are seen, not the mask.

Memory Bank

Range: Touch

Duration: 3 months per level of experience.

Saving Throw: None if willing; standard if unwilling.

P.P.E.: 12

The mage can implant a block of memory/information deep into another person's subconscious mind without them ever knowing what it is. The sorcerer can then retrieve it at any time with a mere touch. This technique can be used to safely record and hide phone numbers, addresses, incantations, or any other data under 100 words. The information can be stored for three months per level of the enchanter. Note: A mind block will make it impossible to implant or retrieve a memory bank. There is no limit to the number of memory banks a mage can implant in the same person. The memory will fade away after the magic's duration time has elapsed.

Ritual: Call Nightlord

Casting Time Required: 1 hour

Range: 1 mile (1.6 km) per level of experience, or 10 miles (16 km) per level of experience if a specific Nightlord is being called.

Duration: Instant

Saving Throw: None

P.P.E.: 25

The sorcerer can contact the Nightlords with this ritual. When successfully completed, the contacted Ba'al or one of his avatars will sense they are being called, and will magically know where the call came from. The magic can reach across the Mirrorwall into both Earth and the Nightlands. There are two versions of this enchantment; one will call the nearest Nightlord or avatar in the area, whether he is on Earth or the Nightlands. The second version calls one specific Ba'al or one of his avatars. Calling a Nightlord when he does not wish to be disturbed is, of course, a very dangerous pastime.

Note: This spell is very rare outside the Cults of Night.

Teleport: Lesser

Range: Five miles (8 km) per level of experience; touch.

Duration: Requires two full melees (30 seconds).

Saving Throw: None

P.P.E.: 15

The power to transmit matter from one place to another. The lesser teleport invocation is limited to non-living substances. Up to 50 lbs (22.5 kg) can be instantly transported from the location of the spell weaver to any location miles away. The only requirements are that the mage touches the object to be teleported and that the location of where it is being sent to is known to him. Success Ratio: 80% +2% per level of experience. An unsuccessful roll means that the object never arrived where it was supposed to and could be anywhere within the mage's range.

Time Slip

Range: Self

Duration: 1/2 melee (7 seconds).

Saving Throw: None

P.P.E.: 20

The invocation momentarily suspends time, enabling the spell caster to slip 7 seconds into the future. The mage can move forward seven seconds while all around him are caught in the past. The magic is such that the arcanists cannot physically hurt any living creature, but can move about the physical environment, open doors, grab an item, run, etc. The effect will appear, to oth-

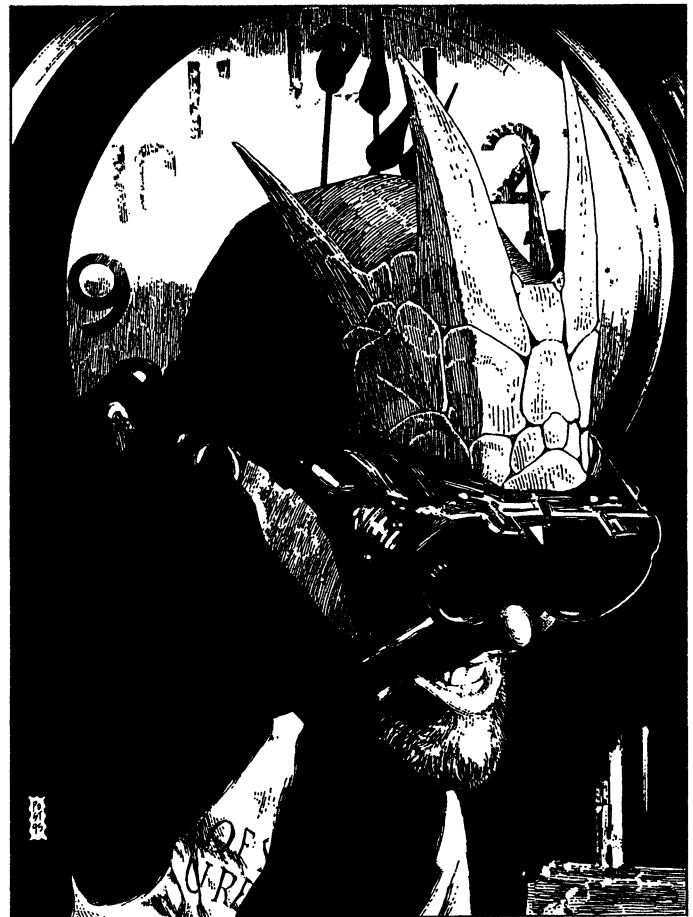

ers, as if the character disappears for an instant and then suddenly reappears a few seconds later. All those around him lose two attacks that melee round, but the mystic retains all of his.

The time slip is ideal for a quick escape. **Note:** Whatever actions the magician takes within the seven seconds are unseen and unknown to the other characters.

Tongues

Range: Self or others by touch.

Duration: 3 minutes per level of experience.

Saving Throw: None

P.P.E.: 12

The magic enables the character to perfectly understand and speak all spoken languages (98% proficiency). An understanding of written languages is not provided by this magic (see the **Eyes of Thoth**).

Words of Truth

Range: 5 ft (1.5 m)

Duration: 1 minute per level of experience.

Saving Throw: Standard

P.P.E.: 15

A person affected by this enchantment is compelled to answer all questions truthfully. The sorcerer must be within five feet (7.5 m) and can ask two brief questions per melee round. It is wise to keep questions simple and clear to avoid confusion.

Saving Throw: The enchanted person makes a saving throw for each question asked. A successful save means the enchanted person doesn't have to answer. Questions can be repeated.

LEVEL SEVEN

Agony

Range: 5 ft (1.5 m) per level of experience.

Duration: 1 minute (4 melee rounds).

Saving Throw: Standard

P.P.E.: 20

A particularly cruel and painful invocation that incapacitates its victim with pain. Under the influence of the magic, the victim has no attacks per melee, cannot move or even speak; only writhe in agony. Although there is no physical damage (no S.D.C. or Hit Points are lost), the pain is very real, and it will take another minute for the victim to regain his full composure. During the second minute his number of attacks and speed are reduced by half, and he suffers a penalty of -1 to strike, parry and dodge. Only one person can be affected per invocation.

Invisibility: Superior

Range: Self or others by touch.

Duration: 3 minutes per level of experience.

Saving Throw: None

P.P.E.: 20

A powerful incantation that makes the spell caster invisible to all means of detection. Infrared, ultraviolet, heat, motion detectors, and even an animal's sense of smell cannot locate the invisible person. No footprints are made, and little sound (Prowl 84%). The magic is broken only if the character makes a hostile move, engages in combat or attacks. At that instant, he becomes completely visible. Note: The invisible character is not ethereal and cannot walk through walls; he must still use a door. The act of forcing open a door or window, picking a lock, tapping somebody, accidentally bumping somebody, or accidentally getting shot or hurt, is not considered an act of aggression or combat, so invisibility is maintained.

Life Drain

Range: 30 ft (9.1 m)

Duration: 2 melees (30 seconds) per level of experience.

Saving Throw: Standard

P.P.E.: 25

The life drain is a debilitating magic that weakens an opponent. The victim will turn pale and experience weakness. Reduce S.D.C. by half, hit points by half, attacks per melee by one, and skills by 10%.

Low level sorcerers (1-3) can only affect one individual per spell cast, but at the fourth level the mage can also cast the magic on a 15 ft (4.6 m) area, affecting everyone who enters and remains in the area of enchantment.

Once the magic's duration time has lapsed, the victim's skills and attacks per melee return to normal S.D.C. at a rate of 8 per hour, and hit points return at a rate of 4 per hour. Reduced speed (half) and a feeling of weakness remains for six hours.

A successful saving throw means the magic has no effect on the person.

Metamorphosis: Animal

Range: Self or other by ritual.

Duration: 20 minutes per level of experience.

Saving Throw: None

P.P.E.: 25

The invocation can completely transform a character into a particular animal, from an alley cat or cocker spaniel to a lion, wolf, alligator or a bird. As the animal, the character gets all the inherent abilities and defenses which that animal form may offer, but retains his own I.Q., ability to speak, memory, S.D.C. and hit points. The mage can return to human form (naked) at will.

To determine the general abilities of an animal type, use the following tables. Note: For an in-depth description of animals and their abilities (monsters too), you might want to take a look at the *Palladium Book of Monsters and Animals*.

Retractable Claws: Small Cats (lynx, bobcat), damage — 1D6

Big Cats (lion, tiger), damage — 2D6

Claws: Digging (badger, wolverine), damage — 1D8

Miscellaneous (rodent, lizard), damage — 1D4

Birds of Prey, damage — 1D6

Bear, damage — 1D8

Teeth: Bear, damage — 2D4; Polar Bear — 2D6

Canine, damage — 1D6; Wolf — 2D6

Feline, damage — 1D6; Tiger/Lion — 2D6

Mustelid, damage — 1D4; Badger/Wolverine — 1D6

Herbivores, damage — 1D4 (horse, goat, ape, human)

Birds of Prey (beak), damage — 1D4

Antlers: Small Antlers — 1D4

Large Antlers — 2D4

Horns: Small Horns — 1D6

Large Horns — 2D6

Hooves: Small — 1D6 (kick)

Speeds:

Wild Canine — about 35 mph (56 kmph) maximum for up to an hour.

Small Wildcats — 15 mph (24 kmph) in spurts of 10 to 20 minutes.

Large Wildcats — 30 mph (48 kmph) in spurts of 10 to 20 minutes.

Cheetah — 90 mph (144 kmph) in 3-5 minute spurts.

Deer/Antelope — 30 mph (48 kmph) maximum for up to an hour.

Horse — 40 mph (64 kmph) maximum for up to an hour.

Elephant — 25 mph (40 kmph) for up to an hour long.

Rhinoceros — 35 mph (56 kmph) in 3-8 minute spurts.

Alligator — 35 mph (56 kmph) in 2 minute spurts

Lizards — 10 to 20 mph (16 to 32 kmph) in 2-5 minute spurts.

Typical Birds — 30 mph (48 kmph) for up to 1D4 hours.

Birds of Prey — 40 mph (64 kmph) for up to 1D4+1 hours.

Nocturnal Animals; Abilities and Bonuses:

1. Extraordinary vision approximately 10 times better than a normal human's. This means that the character can clearly see an 18-inch (0.45 m) item up to two miles (3.2 km) away. Add +3 to Perception rolls involving sight.

2. Nightvision — 600 ft (183 m); can see in the dark.

3. Extraordinary sense of smell allows the character to detect very faint scent traces. Tracking by smell is at a skill level of

35% +5% per level of experience. Identify person by scent has a 48% chance. Add +4 to perception rolls involving smell.

4. Natural Prowl skill is 65% +5% per level of experience.

Paralysis: Superior

Range: 30 ft (9.1 m).

Duration: 1 minute per level of experience.

Saving Throw: Standard.

P.P.E.: 25

This magic temporarily incapacitates its victim, paralyzing him completely. In this state the victim cannot move, or even speak. If damage is inflicted on the victim, the spell is broken and he can move once again. A successful save means the magic has no effect.

Purification (Food/Water)

Range: Touch or 3 ft (0.9 m).

Duration: Instant

Saving Throw: None.

P.P.E.: 20

The mystic can purify food or water, cleansing it of disease, bacteria and poisons/toxins. Up to 50 lbs (22.5 kg) of food or 10 gallons of water/fluids can be purified.

Ritual: An Eye for An Eye

Casting Time Required: 1 minute (4 melee rounds)

Range: Self or others by touch.

Duration: 3 minutes per level of experience.

Saving Throw: None

P.P.E.: 30

This powerful enchantment causes any attack that inflicts damage on the spell caster to magically wound the attacker as well! For example, if an assassin stabs the magician and inflicts 7 points of damage, an identical wound would appear on the assassin's back for the same amount of damage. Only damage that harms the caster's personal S.D.C. and Hit Points is affected by this spell. The caster remains injured by the attacks and must heal his/her wounds through other means.

Second Sight

Range: 5 miles (8 km) per level of experience.

Duration: 2 melees (30 seconds).

Saving Throw: None; mind block will temporarily prevent the use of second sight.

P.P.E.: 20

A unique use of magic that enables a mage to see and hear what another person is doing at that very moment. To use second

sight, the arcanist must have previously encountered/met the individual. The sorcerer just has to think about that person and he will get a clairvoyant-like vision showing what that person is doing and saying, and who he/she is with. The vision is what one might expect to see in a crystal ball except that the arcanist sees it in his mind. The vision lasts only 30 seconds each time the magic is invoked.

A sorcerer can also use second sight to transmit his present activity to another person. This is a great way to show somebody that you are in trouble. **Note:** The image always consists of true event showing exactly what is happening when it is happening. The vision cannot be altered or doctored in any way. Only a mind block will prevent the person from being seen through second sight.

Wind Rush

Range: 120 ft (36.5 m).

Duration: 1 melee (15 seconds).

Saving Throw: Standard; to keep balance.

P.P.E.: 20

This spell creates a short, powerful wind gusting at 60 mph (96 kmph), which is capable of knocking people down, knocking riders off mounts, blowing small objects 20 ft to 120 ft (6.1 to 36.5 m) away, or creating dust storms.

The wind can be directed by the spell caster at a specific target or a general sweep (maximum wind width —20 ft/6.1 m) can be made. Anyone caught in the wind is helpless and unable to attack or move forward. It takes an additional melee to recover, and 1D8 melees to gather up all items blown away.

Saving Throw: A roll of 18-20 saves one from losing one's balance and losing some item(s).

LEVEL EIGHT

Hallucination

Range: Touch or 3 ft (0.9 m).

Duration: 3 minutes per level of experience.

Saving Throw: Standard.

P.P.E.: 30

The invocation creates a mystic illusion or delusion that the mage implants in the character's mind, that only he/she experiences. Whatever the illusion is, whether it be a monster or fire, bottomless pit or a void, it seems completely real to its victim. The person hallucinating will react and interact with the hallucinatory image regardless of what anybody else may say or do. A

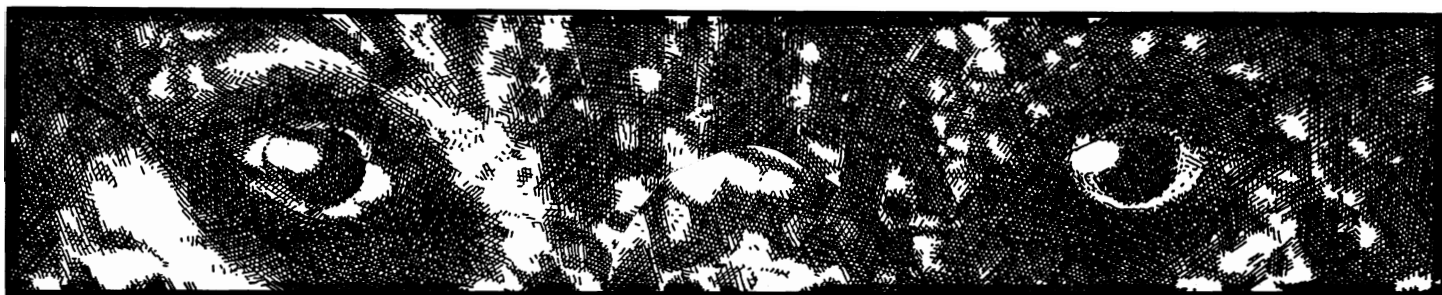

successful save vs magic means that the magic has no effect.
Note: A mind block adds a +3 bonus to save vs hallucinations.

Locate

Range: 15 miles (24 km) per level of experience.

Duration: Instant

Saving Throw: None

P.P.E.: 30

Locate is a magic invocation that enables the sorcerer to sense the general location of his quarry. The location is limited to a general area or environment, like a specific apartment building, house, shopping mall, church, park, on an airplane headed for New York (or wherever), etc.

To locate a particular person the arcanist must have either personally encountered the individual or be provided a photograph. The success ratio for the spell is 41%. The success ratio for a ritual is 89%, but this also requires an object owned by the person or a lock of hair, or fingernail clippings, or dried blood from that person.

Luck Curse

Range: Touch or within 10 ft (3.0 m).

Duration: 24 hours per level of experience.

Saving Throw: Standard.

P.P.E.: 35

The incantation inflicts the person with bad luck. The victim's normal bonuses to strike, parry, dodge, and initiative, and roll with punch, are all reduced to zero; no bonuses! Critical strikes do normal damage (except a natural 20 always does double damage) a death or knockout/stun punch does only 1D4 damage. Kick attacks have a 60% chance of causing the character to trip and fall down. Prowl skill turns into a clumsy roll, making noise every time it is tried. All skills are at a -40%, but only during critical situations. The game master can also add other minor occurrences of bad luck.

Only a remove curse invocation can negate the effect of this enchantment before its duration elapses.

Metamorphosis: Human

Range: Self, or other by ritual.

Duration: 20 minutes per level of experience.

Saving Throw: None.

P.P.E.: 35

A human mage can change his shape, altering his physical structure. The ultimate disguise, the character can change his height, weight, age, hair color, hair length, skin color, gender, and features. A non-human being can transform itself to appear completely human. **Note:** Nightbane cannot alter their Morpheus with this spell, only their Facade. For some reason, their "true shape" is immune to shape-changing magicks.

To attempt to impersonate a real, existing person, the arcanist must have the disguise skill, even though he/she is mentally molding his/her features through magic. A good photograph is required. The success ratio for imitating/impersonating the appearance of a real person is the mage's disguise skill +20%. The better he knows the person the more complete the disguise.

In a ritual version of this same magic, the mage can metamorphosize somebody else, rather than himself. Also in the ritual

magic, the mage can metamorphosize someone else into an exact duplicate of himself. Furthermore, a captive at the ceremony can be duplicated without flaw. **Note:** The metamorphosis process only changes the appearance of the body. The transformed person retains his own voice, memory, skills, and attributes/abilities.

Minor Curse

Range: Touch or within 10 ft (3.0 m).

Duration: 24 hours per level of experience.

Saving Throw: Standard.

P.P.E.: 30

The spell caster can inflict a curse in the form of minor physical disorders that cause a constant irritation. Such disorders include:

Fever: -2 on initiative, -5% on all skills, reduce speed and endurance (P.E.) by 25%. Fever ranges from 99 to 102 degrees, victim feels drained, tired, and uncomfortable.

Gas: Some indigestion and nausea, bloated feeling. Farts once every two melees (pee-u). -2 on initiative, sneak attacks and prowls are impossible.

Headache: Dull, throbbing headache; sleep and concentration are difficult. All skills are -10% and all saving throws are -1 (lack of focus).

Hiccups: Annoying; interrupts speaking constantly. Language skills are -15%, mental affinity (M.A.) is reduced by half. Prowl is impossible. Spells can still be cast with little difficulty.

Ingrown Toenail: Painful to walk, victim limps. Reduce speed by 1/3, prowl is -10%, climb is -15%.

Itching and Rash: Very uncomfortable; almost maddening itch that can be relieved only by scratching. Reduce mental affinity (M.A.) by half, -4 on initiative and minus one attack per melee.

Pimples: Dozens of pimples break out all over the face and arms. Reduce physical beauty by half.

Nausea: Stomach ache, loose bowels and vomiting slow this poor victim down. Reduce speed to a comfortable half normal (running faster is possible, but there is a 50% chance of vomiting). Sudden movements, bumpy rides, or high speed chases (50 mph/80 kmph or faster) have a 60% chance of inducing vomiting or diarrhea. The victim is -6 to strike, parry and dodge while throwing up, and has no initiative.

Runny Nose and Cough: The victim suffers from a nagging, constant cough, watering eyes and runny nose. Reduce physical beauty by 25%. Prowling and sneak attacks are impossible. Spell casting is unimpaired.

Vertigo: The character gets dizzy when running (speeds higher than 8), during high speed chases (50 mph/80 kmph or faster), or when exposed to heights (must be looking out a window or standing on a ladder or ledge, and so on, higher than 10 ft/3.0 m). When the vertigo hits, the character is almost helpless; reduce attacks per melee to one, no initiative, -8 to strike, parry and dodge. The vertigo will last as long as the victim is exposed to what induces it.

No normal medicine or cures will rid a character of a curse. Only a remove curse incantation can do it, or waiting until the duration time of the curse elapses. A negation spell can be tried, but it has only a 25% possibility of success.

Negation (of Magic)

Range: Touch or within 60 ft (18.3 m).

Duration: Instant

Saving Throw: Special (ritual magic has a greater chance of success).

P.P.E.: 30

This incantation will instantly cancel the effects or influence of most magic. To determine whether the negation is successful or not roll a saving throw. If the roll is a successful save against the magic used, its influence is immediately destroyed/negated/canceled. 12, 13, 14 or 15 is needed for spell magic depending on the experience level of the magic. A failed save means the negation attempt did not work. Try again if sufficient P.P.E. is available.

Negation will not work against possession, exorcism, constrain being, banishment, talisman, amulet, enchanted objects, symbols/circles of protection, wards, summoning magic, zombies, golems, restoration or healing/cures. Negation can be attempted to cancel a curse, but only has a 25% possibility of succeeding, and that's only if the saving throw was successful. It also has no effect against psychic abilities or Nightspawn talents.

Nightland Portal (Ritual)

Casting Time Required: One hour

Range: 20 ft (6.1 m) area.

Duration: 1 minute per level of experience.

Saving Throw: None.

P.P.E.: 50

The sorcerer has the ability to open a dimensional gateway into the Nightlands (or, if cast in the Nightlands, to Earth). The portal reaches the corresponding place in that shadowy dimension. So, for example, if this invocation is conducted in an Earth city, the doorway will open to the middle of its corresponding Nightlands City-state. While the gate is open, anybody can cross into or out of the Nightlands, or vice-versa.

Oracle

Range: Self

Duration: 1 minute (4 melees).

Saving Throw: None.

P.P.E.: 30

The oracle is the magic equivalent of clairvoyance. The arcanist receives a dream-like vision of a possible future. The focus of the vision will depend on what, when or whom the mage is thinking about. The same basic rules that apply to clairvoyance apply to the "oracle" invocation.

Sickness

Range: Touch or 20 ft (6.1 m)

Duration: 12 hours per level of experience.

Saving Throw: Standard.

P.P.E.: 50

Sickness is a debilitating magic which afflicts its victims with the symptoms of a specific disease. Only the symptoms of the disease manifest themselves, not the actual disease. Consequently, a medical examination will show there to be no physical cause to the illness. At best, it will be diagnosed as psychologi-

cal or unknown. No matter how ill or helpless the victim may become he can not die from the magic sickness. But the character will suffer greatly.

All sickness inflicted by this magic is severe, inflicting the following penalties and modifiers: Attacks per melee are reduced to one, physical endurance is reduced by 70%, -4 to strike, parry and dodge, no initiative, and skills are reduced by 40%. The person is very weak, disoriented and uncomfortable.

Spoil (Water/Food)

Range: Touch or 3 ft (0.9 m).

Duration: Instant

Saving Throw: None.

P.P.E.: 30

Basically, this magic is the opposite of the purification (food/water) incantation. In this case, the mage can instantly transform good food into spoiled, affecting 50 lbs (22.5 kg) or two gallons (37.9 liters) of water/fluids, making the food inedible and the water undrinkable. Anybody who forces himself to eat or drink the horrible tasting food or drink will get sick with stomach cramps and diarrhea. Penalties: -1 on initiative, -1 to strike, parry and dodge.

Temporary Enchantment (Ritual)

Range: Touch

Duration: One week per level of the caster.

Saving Throw: Standard.

P.P.E.: 70

This incantation enchants a weapon, allowing it to inflict double damage to supernatural creatures, or normal damage to creatures normally unaffected by normal weapons. A missile weapon enchanted in this manner will extend the enchantment to any ammunition it fires.

The weapons get a saving throw, at +1 if it is an archaic missile weapon (like a bow or crossbow), or at +3 if it is a high-tech weapon (like a gun).

LEVEL NINE

Curse: Phobia

Range: Touch or 20 ft (6.1 m).

Duration: 24 hours per level of experience.

Saving Throw: Standard.

P.P.E.: 40

The phobia curse implants in its victim an unreasoning fear of something (see phobia in the Insanity section). The sorcerer can select one of the phobias listed in the insanity section or make a random roll on that table or introduce a new phobia (new phobias must be approved by the game master). The victim of the curse will have a phobic reaction every time he encounters that fearful thing. Only a remove curse is a 100% cure, negation has a 25% chance of success, and, of course, the mage who created the curse can cancel it at any time.



Familiar Link

Range: Self and animal (600 ft/183 m).

Duration: Indefinite

Saving Throw: None.

P.P.E.: 55

At third level, a practitioner of magic is experienced enough to mentally link with a small animal (mammal, bird or lizard). This link is permanent, producing a rather impressive symbiotic relationship. No matter how wild or mean the animal may have

been, it will be instantly linked to the mage, becoming docile and submissive to him and him alone. The two are now one. The spell caster is its friend and master, an extension of the animal. The animal familiar will understand and obey any command, verbal or mental. For the mage, the familiar is now a sensory extension enabling him to see, hear, smell, taste and feel everything the animal experiences. Thus, familiars make great spies; listening to conversations and prowling into areas not easily accessible to its master. Although the familiar understands and obeys its master, it cannot actually speak to him.

Just as the arcanist knows what the familiar is feeling, so does the familiar know what its master is experiencing. If one is in danger the other will know it. because of the magical nature of the union, the mage and the familiar both get an additional six hit points. However, if the familiar is hurt or attacked, its master also takes the same damage even if miles apart. **If the familiar is killed**, the arcanist *permanently loses 10 hit points*. There is a 50% chance he will also suffer shock from the ordeal; if he does, he will lapse into a coma for 1-6 hours. Another familiar link cannot be tried again for at least 1/2 a year.

Other Limitations:

1. Telepathic/empathic communications: maximum range: 600 ft/183 m.
2. Familiar possesses its normal abilities.
3. Size: 25 pounds (11 kg) maximum.
4. Usual animal types used: cats, dogs, coyotes, foxes, weasels, rodents, birds, lizards, and snakes.

Metamorphosis: Insect

Range: Self, or others through ritual magic.

Duration: 20 minutes per level of experience.

Saving Throw: None.

P.P.E.: 60

The mage can transform himself into an insect, including spiders, that is no smaller than a half inch (12.7 mm) and no larger than six inches (0.15 m). In insect form, the mage retains his own I.Q., memory, hit points and S.D.C.; however, the performance of human skills is impossible as a bug. Likewise, magic cannot be cast because as an insect he cannot speak. The metamorphosis can be canceled at will, but the sorcerer will be naked.

The following are some of the typical bug abilities:

Bite or Sting:

Nonpoisonous: One hit point or S.D.C. damage.

Non-Lethal Poison: 1D6 damage, causes swelling and discomfort.

Speed:

Running: Speed attribute equal to 8.

Climbing: Speed attribute equal to 6.

Flying: 20 mph (32 kmph) for extended flight.

35 mph (56 kmph) for short bursts (30 seconds).

Note: Seems to never tire and can walk on any surface.

Protection Circle: Simple

Range: Radius of the circle.

Duration: 24 hours, plus 4 P.P.E. to reactivate after the circle's initial creation.

Saving Throw: None.

P.P.E.: 45

Even as a spell, this invocation might be considered a ritual, for it requires the physical drawing of a circle and symbols while the spell incantation is recited. Chalk or charcoal, or almost any substance, can be used to draw the circle. 45 P.P.E. points are needed to initially create the circle, but a mere four P.P.E. is all that is needed to reactivate it. Anybody with sufficient P.P.E. and desire can reactivate a protection circle. However, if the circle is damaged (scraped, scarred, rubbed out, etc.) it will not function and a new one will have to be created.

The simple protection spell will protect everybody inside its radius by keeping lesser supernatural creatures five feet (1.5 m) away from the circle. The creatures cannot come any closer, nor enter the circle. The circle also provides its occupants with a bonus of +2 to save vs magic and psychic attacks.

Although lesser supernatural creatures, such as entities, ghouls, and gremlins, cannot come near or enter the circle, they can hurl objects, use weapons, or use magic and psychic powers against the person(s) inside the circle. Greater beings, such as vampires, elementals, Hounds, Hunters, and Nightlords are not affected by the simple circle and can enter effortlessly. No bonuses vs magic apply against these powerful beings.

Summon and Control Canine

Range: Varies

Duration: 5 hours per level of experience.

Saving Throw: Standard animal, but only if a part of the player character's group.

P.P.E.: 50

All pentacles and pentagrams are used for summoning or potentially evil intent. The Chinese geomancers found that circles represent mutual support, the cycle of life, and flowing energy. But pentacle, the five pointed star, represented mutual destruction and evil. That is why all protection magic incorporates the circle and all summoning utilizes the pentagram.

The summon and control canines pentacle will provide 1D4 canines (dogs, wolves, etc.) plus one additional canine per level of experience. The animals will be under the complete control of the mage, obeying his every command, and will fight to the death. The pentacle will also give the sorcerer the power to control any other canines which were not originally summoned, within 200 ft (61.0 m)/line of vision, as long as the mystic remains in the pentacle. The canines originally summoned will obey the arcanist in and out of the pentagram for the duration of the enchantment, then leave.

Curse: Temporary Insanity

Range: Touch or 20 ft (6.1 m).

Duration: 24 hours per level of experience.

Saving Throw: Standard.

P.P.E.: 45

This invocation temporarily renders the person insane! Roll on the insanity tables to determine the exact nature of the curse. The effects of the madness can only be reversed by a remove curse (a negation has a 25% chance of working). If the spell is cast against a player character, the change in behavior should be role-played fully.

Transferal

Range: Touch or 10 ft (3.0 m).

Duration: One hour per level of experience.

Saving Throw: Standard.

P.P.E.: 50

The spell caster can use this magic to temporarily transfer his mystic essence into another person by transferring all but 4 P.P.E. and experience into that individual. A See Aura would reveal no magic, little P.P.E. and no levels of mystic experience. It is an excellent way to hide one's mastery of magic when needed.

The person to whom the P.P.E. and experience have been transferred to is completely unaware of the power within him and cannot use it. The mystic who has temporarily drained himself of magic retains his mystic knowledge, but has only 4 P.P.E. and can create magic only at first level of proficiency. He can regain his power by touching the person who holds it or by waiting until the magic's duration time elapses.

LEVEL TEN

Banishment

Range: 100 ft (30.5 m)

Duration: 2 weeks per level of experience.

Saving Throw: Standard.

P.P.E.: 65

A useful invocation for controlling supernatural beings is Banishment. The magic forces one lesser supernatural being/demon per experience level of the spell caster, to leave the immediate area (600 ft/183 m radius). The creature(s) cannot return for at least two weeks per level of experience. Each lesser being gets to roll to save vs magic. A successful save means it is not banished and can stay to cause trouble. As always, a banishment ritual has a greater chance of success (16 or higher is needed to save).

Note: Works against Hounds, Hunters and Ashmedai; if they fail to resist, they are banished back to the Nightlands. Does not affect Nightbane, Guardians, Nightprinces, avatars or Nightlords.

Bind Nightbane

Range: 200 foot (61.0 m) radius circle.

Duration: 2 hours per level of experience.

Saving Throw: Standard.

P.P.E.: 70

This incantation is designed to exert power over the Nightbane. It is known only by a few sorcerer brotherhoods and is very rarely passed on to outsiders. If the Nightbane(s) in the area fails his saving throw, he is partially controlled by the mage. The sorcerer can prevent the Nightbane from leaving the boundaries of the circle (or, alternatively, he can expel the Nightbane and make it impossible for him to enter the area affected). He can also keep the Nightbane from moving (the character can save every melee round to fight the paralysis; a successful save breaks the paralysis but does not remove the circle's power). More importantly, the caster can force the Nightbane to remain in either Morphus or Facade form! Typically, the arcanist will choose the weaker Facade for his victim(s).

Bonding (Ritual)

Range: 12 miles (19.2 km) per level of experience.

Duration: Varies with each individual spell.

Saving Throw: Standard, with a -1 penalty to save.

P.P.E.: 80

Bonding is a powerful ritual incantation that combines magic to strike at somebody from a great distance. The arcanist makes

a clay, straw or rag doll in the image of a man or woman. Then a lock of hair or fingernail clippings from the intended victim is glued to the doll effigy. To complete the magic the incantation is performed and the victim's true name (first, middle and last) must be known (if the person has no middle name, only the first and last must be known). When this has been done, the doll is magically linked to that specific individual. This means that non-energy magic, like befuddle, fear, breathe without air, trance, calling, heal wounds, compulsion, sickness, curses and so on, can be cast on the doll effigy and it will affect the real person. Summoning and protection magic, as well as energy magic like energy bolt, call lighting, fire bolt, telekinesis, etc., cannot be used on the doll with any effect.

Pins and needles can be used to inflict stabbing pain into the victim. This is done by stabbing the doll with the instruments of torture. The victim will double over with pain, losing all but one attack that melee and is -4 to strike, parry and dodge. Despite the great pain, the needle inflicts only one S.D.C. point of damage each time. Fire can be used to wear a character down with fever-like symptoms: feels like he's burning up from heat, sweats profusely, speed is reduced by 25%, skills are at -5%, -1 to strike, parry and dodge. Needles and fire can be inflicted for a total of one minute per level of experience of the enchanter. The magic spells or ritual magic will last as long as the normal duration for that particular spell. No more than two spells can be inflicted on the victim at any one time.

The initial bonding ritual requires 80 P.P.E. plus the P.P.E. cost of whichever invocation is being cast on the victim. The mystic assault happens as soon as the spell is finished and will last the usual length of that spell. Shortly after the spell is cast the bonding magic becomes too weak to transmit other magic. However, the link between the living person and the doll continues to exist. The mystic can bring the bonding magic back up to full power (and be able to inflict more magic on its victim) by repeating the bonding incantation and spending 40 P.P.E. points. Each renewal provides the sorcerer with the opportunity to inflict more magic on his victim or one minute per level of experience to use needles or fire on the doll. Remember, no more than two spells/invocations can be used on a person at any given time. Consequently, if the victim is still under the effect of an invocation, only one new one can be cast upon him. The victim always gets to save vs each magic spell. A successful save means it has no effect; try again.

Control/Enslave Entity

Range: 30 ft (9.1 m)

Duration: 48 hours per level of experience.

Saving Throw: Standard

P.P.E.: 80

Another incantation used to control supernatural forces. This magic does not summon entities, but does enable the mage to control them when encountered. The arcanist can control two entities per level of experience. All varieties of entities are susceptible to this enchantment. Each individual entity gets to make a saving throw vs magic. A successful save means it is not controlled by the arcanist. A failed roll means it will obey the sorcerer to the best of its ability (some are barely intelligent).

At the end of its mandatory service to the sorcerer, the mage can try to renew his control by using the invocation again, ban-

ish the creature, or simply let his control slip away. The latter can be dangerous, because the evil beings may turn on the mage to extract vengeance or just out of spite. On the other hand, the more intelligent types may willingly agree to work with the sorcerer, especially an evil one, if it will help the diabolical being in its own schemes to inflict pain and suffering.

Curse: Paranoia

Range: Touch or 20 ft (6.1 m).

Duration: 24 hours per level of experience.

Saving Throw: Standard.

P.P.E.: 70

This curse inflicts extreme paranoia on its victim. The poor individual will become convinced that he can trust or believe no one, regardless of past friendships. The afflicted character will see everybody as sinister and treacherous beings, probably associated with supernatural evil. They all covet his possessions, knowledge or death. Any act of aggression toward the paranoid will convince him of treachery and he will react in kind. General reactions will include secretiveness, hiding data and items of importance, staying aloof and alone, lying, and an immediate, hostile counter-response to any perceived threats.

Metamorphosis: Superior

Range: Self, or others by use of ritual only.

Duration: 20 minutes per level of experience.

Saving Throw: None; standard if an unwilling victim.

P.P.E.: 100

The incantation enables the spell caster to transform himself into any real, living creature, animal, human, supernatural or insect. The usual limitations and abilities still apply. The mage can also transform himself to *resemble* a supernatural creature, but does not possess any of its power and abilities. A person other than the sorcerer can be transformed, but a lengthy ritual magic must be performed to do so. The individual will remain in metamorphosed form until the spell's duration elapses or the mage who invoked it cancels it.

Summon/Control Rodents (Ritual)

Range: 600 ft (183 m)

Duration: Five hours per level of experience.

Saving Throw: Standard animal.

P.P.E.: 70

This pentacle of summoning produces an army of mice or rats that obey the will of the sorcerer who summoned them. As long as the mage stands in the pentagram he can control any other types of rodents. **Note:** Familiars are not affected.

The sorcerer can summon 30 rodents per level of experience. Mice and rat bites inflict one point of damage each. Mice have one attack per melee, rats have two. All are +1 to dodge and are excellent climbers.

Summon Nightlands Denizen (Ritual)

Range: Immediate

Duration: 1 hour per level of experience.

Saving Throw: None.

P.P.E.: 75

This ritual summons to Earth a Nightland creature of the caster's choice, limited to Hounds, Hunters and Doppelgangers. The Doppelganger of a living person, if one exists (Game Masters' choice or 20% chance) can be summoned in this manner. This ritual does not provide any means to control the summoned creature, so the sorcerer must be prepared to deal with the newcomer in some other way. When the duration of the spell elapses, the creature is sent back to its homeland.

Wards

Range: Varies with type.

Duration: Effects vary with type.

Saving Throw: Standard

P.P.E.: 90

The ward's invocation creates mystic symbols used to protect items of value, to protect dwellings, and as booby traps. The ward can be cast on a door or window, a section of floor, a cabinet or on a specific item, such as a book or statue. The ward symbols on the object are always obvious, to serve as a warning. When somebody other than the sorcerer who created them touches the object, a spell is triggered. The following wards can be created. Each ward invocation will create two separate wards, the ritual invocation will create three. The object to be warded must be present.

Alarm: A screeching, siren-like noise is instantly sounded and continues to blare for TEN minutes. The sound can be easily heard through closed doors up to 100 ft (30.5 m) away.

Fear: An aura of fear engulfs everybody within a 20 foot (6.1 m) area of the ward. Each person must roll to save vs magic or be overwhelmed by terror. Effects are identical to the second level fear invocation.

Fire Bolt: The person touching the item is struck by a fire bolt causing 6D6 damage; no saving throw is applicable. Same as the fourth level invocation.

Paralysis (lesser): The ward temporarily paralyzes the person's hand and arm for 1D4 hours. The effects are identical to the third level invocation.

Sleep: The ward will put to sleep everybody within 10 foot (3.0 m) of it. Each person must roll to save versus magic. The sleep lasts for 6D6 minutes. As per the fifth level spell.

Agony: The person who touches the object is racked with agony for 2D8 melees. The effects are identical to the seventh level invocation.

Curse (minor): Inflicts a minor curse identical to the eighth level invocation except that it will linger for 1D6 weeks.

Curse (phobia): Inflicts a phobia curse identical to the ninth level spell except that it will linger for 1D4 weeks.

Banishment (counts as two wards): will instantly force lesser supernatural beings from the area, just like the tenth level invocation. Plus, the creature must leave the object where it rests.

After a ward has been triggered, its magic is used up and it disappears. A ward can last for centuries if left undisturbed. The life span of the ward is 150 years per level of the arcanist.

LEVEL ELEVEN

Control Nightlands Denizen

Range: 30 ft (9.1 m)

Duration: 24 hours per level of experience.

Saving Throw: Standard.

P.P.E.: 85

An incantation specially designed to control the servants of the Nightlords (Hounds, Hunters and Doppelgangers). This ritual does not summon the creatures, but enables the sorcerer to control them when encountered, or if summoned through a different spell. The sorcerer can control two Doppelgangers or one Hound or Hunter every time the incantation is used. The creature gets to make a saving throw vs magic. This saving throw is at +4 if the sorcerer is directly working against the Nightlords, and at -4 if the mystic is serving the Nightlords, directly or indirectly. A successful save means the creature is not controlled by the arcanist. A failed roll means it will obey the arcanist to the best of its ability.

At the end of the mandatory service to the arcanist, the mage can try to renew his control by using the invocation once again. Alternatively, he may try to banish the creature or just let his control slip away. If the latter happens, the creature may decide to turn against the sorcerer.

Create Magic Scroll

Range: Identical to spell placed on scroll.

Duration: As per scroll.

Saving Throw: Standard magic save.

P.P.E.: 100 plus the P.P.E. needed to cast the magic spell placed on the scroll.

The arcanist is able to transfer mystic energy and powers into an inanimate object. In this case, the mage can magically make the words to a magic spell appear on paper. The only real limitation other than sufficient P.P.E. is that the mage must be able to read and write. Some modern-day sorcerers have been able to transfer the spell to a computer disk instead of paper! The "scroll" must still be read aloud for its magic to work, but some "techno-wizards" have taken to carrying desktops with several "scrolls" loaded into their hard disks! Computerized scrolls cannot be "copied" successfully; each document thus created is the only one, and it disappears from the computer's memory when used.

The invocation is created by writing the words of the spell in the sand or dirt with a stick while speaking the words aloud. The words magically appear on the paper (or computer screen) as he writes and speaks them. When done the spell has been transferred to the paper and can be read and used by anybody who can read the particular language it was written in. Because the paper or parchment has been charged with P.P.E., anyone, fellow mage or housewife, can read the scroll and the magic spell will be cast. To activate the scroll the spell must be read aloud.

The words on a scroll disappear the moment they are read aloud, leaving only a blank piece of paper. No camera of any kind can photograph (record) the mystic writing (appears blank) and nobody can copy the spell down. This is why scroll conversion is so difficult.

Note: the power of the scroll-spell can be controlled by its creator and can range from level one potency to the current level of its creator. However, the creator's enhanced spell strength cannot be transferred, so all saving throws from scroll magic are 12 if created as a spell or 16 if created as a ritual.

Curse: Neurosis

Range: Touch

Duration: 24 hours per level of experience.

Saving Throw: Standard

P.P.E.: 95

The incantation afflicts its victim with a neurotic disorder. The sorcerer can implant one specific neurosis or roll on the random neurosis table of the insanity section. The insanity is temporary and fades away several days after the duration time has elapsed.

Nightlands Passage

Range: 10 ft (3.0 m) radius per level of experience.

Duration: Instant

Saving Throw: Standard if unwilling to be transported.

P.P.E.: 100

This invocation instantly transports the caster and anybody/anything within the radius of the effect (10 ft/3.0 m per level of experience) into or out of the Nightlands. The caster and other "passengers" will be transported into the corresponding point in the Nightlands. Unwilling passengers get a saving throw vs magic; a success means they remain behind as the rest are teleported out.

Remove Curse

Range: Touch or 10 ft (3.0 m).

Duration: Instant removal

Saving Throw: None.

P.P.E.: 140

The mage can attempt to remove any type of curse using this incantation. To determine success a 20-sided die is rolled (plus bonuses) to save vs magic. A successful save means that the curse is instantly gone. A failed roll to save means the curse is still in effect. Try again with a new invocation and another 140 P.P.E.

The remove curse is a powerful magic that provides bonuses to save vs magic and to remove that curse. Those bonuses are:

Spell: +5 to save.

Ritual: +10 to save.

Summon and Control Animals (Ritual)

Range: 600 ft (183 m)

Duration: 5 hours per level of experience.

Saving Throw: Standard for animals.

P.P.E.: 125

A superior summoning pentacle, the invocation empowers the arcanist to summon and control any type of animal.

Tiny animals like frogs and mice — 40 per level of experience.

Medium-sized animals like dogs and cats (up to 30 lbs/13.6 kg) — 8 per level of experience.

Large animals like horses — 6 per level of experience.

Exotic animals, including animals which are not indigenous to the area, i.e., animals such as a tiger, panther or elephant are not native to New York City. Only one per level of experience.

As usual, any animal who comes into the arcanist's 600 foot (183 m) range while in the pentagram will obey the mage unless it makes a successful save vs magic. Familiars are not influenced by the control of this pentagram.

Summon Fog

Range: Up to 10 miles (16 km) per level of experience.

Duration: 1 hour per level of experience.

Saving Throw: None.

P.P.E.: 140

The spell caster can call forth a dense fog that will impair vision and make travel difficult. The fog is so thick that a person can only see clearly for four feet (1.2 m) and see only blurred, shadowy figures and shapes for about another 10 ft (3.0 m). Anything beyond 10 ft (3.0 m) is totally obscured by fog. The fog can be made to cover a one mile area (1.6 km) per level of the sorcerer.

Safe travel is slowed to a crawl. On foot, a safe speed is 10 or less, and even then there is a 30% chance of tripping over something every 30 ft (9.1 m) or so. A completely safe speed is 3. Running faster than a speed of 10 is hazardous, with a likelihood (60%) of falling every 30 ft (9.1 m) of travel. All sense of direction is lost. A safe speed for an automobile is 5 mph (8 kmph). Up to 20 mph (32 kmph) can be attained, but the risk of running off the road is 60%, and for every half mile there is a 40% chance of crashing into something. Traveling faster than 25 mph (40 kmph) is certain disaster, with an 85% likelihood of running off the road and a 70% of crashing. Roll for every 600 ft (183 km). Air travel is impossible.

Bonuses and Penalties: The fog adds a +20% to prowl skills. Long range combat and gunfights are extremely difficult. All such attacks, including distance magic and psychic attacks, are -5 to strike and opponents are +2 to dodge each other's attacks.

The summoner can cancel the fog at any time or let it last out its full duration. It can be summoned day or night, any time of the year.

Summon Nightlord Avatar

Range: Immediate

Duration: 1 hour per level of experience.

Saving Throw: Standard if the Avatar resists the summons (+5 to save).

P.P.E.: 150

This risky ritual summons a specific Avatar of a Nightlord. The Avatar must be known by its given name and must be still active/living. The invocation will summon the Avatar from anywhere in the Nightlands or Earth, but if the Avatar is reluctant to be summoned, he resists the spell with an additional +5 to his saving throw. A reluctantly summoned avatar will arrive ready to fight and punish the sorcerer who dares to summon him. Even one who does not resist the summoning may have done so just to be able to teach the impudent mortal a lesson. The invocation

does not offer any way to control or restrain the creature. For the most part, it is only used by cultists and servants of the Ba'al.

LEVEL TWELVE

Amulet

Range: Holder/wearer of the amulet.

Duration: Exists as long as the medallion is not destroyed.

Saving Throw: None.

P.P.E.: 290 or more.

The "amulet" is a potent invocation that instills a medallion of charm with mystic properties that will protect an individual from magic or supernatural forces. The only requirement of the invocation is that the amulet be made of one metal purified by fire or made of semiprecious stone.

The sole purpose of an amulet is to protect. Protection is provided in several different ways. Any one of the following can be created by the amulet invocation.

Charm: A general ward against magic that provides a bonus of +1 to save versus magic and psychic attacks. **P.P.E. Cost:** 290

Protection Against Sickness: Amulet that specifically protects against the eight level magic invocation "sickness." Bonus of +6 to save. **P.P.E. Cost:** 290

Protection Against Insanity: Adds a bonus of +4 to save against all magically induced insanities. **P.P.E. Cost:** 320

Protection Against the Supernatural: Adds a bonus of +2 to save vs horror factor. **P.P.E. Cost:** 300

See the Invisible: Enables only the wearer of the medallion to see the invisible. **P.P.E. Cost:** 500

Sense the Presence of Spirits: The amulet changes color whenever an entity(s) is in the area. Range: 60 ft (18.3 m). **P.P.E. Cost:** 310

Turn the Undead: A charm that will prevent any of the undead from physically touching them while they wear or hold the amulet. The amulet works much like a cross does against vampires. Effective against all undead. **P.P.E. Cost:** 400

Calm Storms

Range: Immediate area around the mage, affecting a one mile (1.6 km) area per level of experience.

Duration: 1 hour per level of experience.

Saving Throw: None.

P.P.E.: 200

Using ritual magic the mystic can turn a torrential rain into a drizzle, reduce winds to a gentle breeze, shrink ocean waves to normal, disperse a tornado in an instant and get the sun to peek through clearing skies.

Metamorphosis: Mist

Range: Self, or others through ritual magic.

Duration: 20 minutes per level of experience.

Saving Throw: None or standard if an unwilling subject.

P.P.E.: 250

Said to be the most powerful of all the metamorph magics, the mage can transform himself into a mist. As a mist, no physical or energy attacks can harm him. No locked door can stop him, for he can slip through the tiniest crack or keyhole. Although the mystic cannot communicate or cast magic, he can hear and see events around him as would a normal human being. Of course, he can materialize (naked) with a thought.

The mist moves at a maximum speed of 14. Prowls (natural, innate ability) at an 80% skill proficiency, is completely silent, can hover up to 100 ft (30.5 m) high, and is semi-transparent.

Summon and Control Rain (Ritual)

Range: Immediate area around the mage, or up to 10 miles (16 km) away per level of experience.

Duration: 1 hour per level of experience.

Saving Throw: None.

P.P.E.: 200

The sorcerer can create a rainstorm out of thin air. The rain can be controlled to be a drizzle, light rain or downpour. One mile (1.6 km) per level of experience can be affected by the rain. A heavy storm will reduce visibility and slow travel.

LEVEL THIRTEEN

Enchant Weapon (Ritual)

Range: Touch

Duration: Permanent, or until the weapon is destroyed.

Saving Throw: None.

P.P.E.: 300 or 600.

This invocation is similar to the *charm weapon* spell but is more powerful. An enchanted weapon will *permanently* charge a weapon with mystical energy, enabling it to damage supernatural beings, including vampires. It will inflict double damage to all supernatural creatures (including Nightbane, Guardians, elementals and dragons), but does normal damage to humans and other S.D.C. beings. Missile weapons (guns, bows, crossbows, etc.) can be enchanted in the same manner, but it costs double the P.P.E. (600 points). Any projectile fired by the enchanted weapon will be considered to be enchanted and inflict double damage to supernatural foes.

Protection Circle: Superior

Range: Radius of the circle.

Duration: 24 hours, but can be reactivated immediately at a cost of 20 P.P.E.

Saving Throw: None.

P.P.E.: 250

In principle and function, the superior protection circle is just like the simple circle, only stronger. The sorcerer must recite the invocation while drawing the circle in chalk or any substance. 250 P.P.E. are needed to initially create the circle, but a mere 20 P.P.E. will reactivate it. Anybody with sufficient P.P.E. and desire can reactivate a protection circle. The circle ceases to function only if it is seriously marred.

The superior protection circle will protect everybody inside its radius by preventing any supernatural creatures from coming any closer than 20 ft (6.1 m) from its edge. Even greater beings (including the Nightlords) are held at bay. Lesser beings cannot stand to be within line of sight of the circle and are forced to leave (even if it's only to the next room with the door shut). This means no attacks are possible from the lesser beings.

The circle also provides the following bonuses to all occupants: +5 to save vs all magic and psychic attacks, impervious to possession, +8 to save vs horror factor. Plus it provides an extra 10 P.P.E. to each mage and 10 I.S.P. to each psychic. Of course, the characters are vulnerable to conventional weapons and thrown objects.

Summon Storm

Range: Immediate area around the mage or up to 10 miles (16 km) away.

Duration: 1 hour per level of experience.

Saving Throw: None.

P.P.E.: 300

The spell caster can create a destructive storm out of thin air. A rainstorm will create a torrential downpour of 4 inches of rain per hour, causing flooding even in cities. Flooded roads will immobilize all vehicles (water is 3 to 5 ft/0.9 to 1.5 m in height). Poor visibility will slow travel to about 20 mph (32 kmph). Traveling fast is likely to cause an accident. Roll on the following table for every two miles (3.2 km) traveled.

01-30 No problem, keep going.

31-39 Vehicle stalls out. 1-50% chance of restarting.

40-69 Vehicle runs off road and is immobilized.

70-00 Vehicle crashes into an obstacle or another vehicle. Vehicle is immobilized. All passengers roll 2D6 damage for every 10 mph (16 kmph) of vehicle speed.

The storm is accompanied by damaging winds gusting to 35 and 45 mph (54 to 72 kmph). The rain and wind makes air travel impossible.

A windstorm may be accompanied by light rain, but the real threat is high winds. Winds gust up to 70 and 90 mph (112 to 144 kmph), uprooting small trees, knocking down tree branches and electrical wires, and even overturning an occasional car. Travel on foot is very difficult, reducing a character's speed by 90%. Travel in automobiles is slowed to about 20 mph (32 kmph). Traveling any faster is likely to cause the vehicle to run off the road and flip over. Roll 40% +10% for every 10 mph (16 kmph) above 20 mph (32 kmph). Roll once for every 4 miles (6.4 kmph) of travel. Air travel is extremely hazardous.

Summon Nightlord

Range: Immediate

Duration: 30 minutes per level of experience.

Saving Throw: If the Nightlord is unwilling, he saves at +8.

P.P.E.: 425

This dangerous and little-known invocation will summon a Nightlord from anywhere on Earth or the Nightlands. However, if the Nightlord does not wish to be summoned, his normal saving throw vs magic is at +8. If he fails his save, the Nightlord will arrive in a state of rage, ready to destroy the sorcerer unless

he can be somehow restrained or convinced otherwise. For the most part, the ritual is cast only by sorcerers who are allied or work for the Nightlord, and when their master is expecting the summons. The title/given name (not the real name) of the Nightlord is necessary to cast the invocation.

Sanctum

Range: 30x30 ft (9.1x9.1 m) room. Can be created up to 200 miles (320 km) away.

Duration: The lifetime of the mage or until canceled.

Saving Throw: None.

P.P.E.: 390

The mage can protect a room of up to 30 x 30 ft (9.1 x 9.1 m) from mystic influence by using the sanctum invocation. The room is instantly turned into a safe haven, or sanctum, free of mystic disturbance. While inside the room, the mage cannot be found by the locate spell, cannot be seen by second sight, and cannot be affected by bonding magic. These protections work only within the room. Even more impressive is that animated dead and undead cannot enter the sanctum. Lesser monsters cannot enter unless they save vs magic (included Hounds and Hunters). Greater beings and humans are not affected and enter at will.

Talisman

Range: Varies with type of spell.

Duration: Talisman exists until destroyed.

Saving Throw: Standard.

P.P.E.: 500

The term talisman is believed to have its roots in the Arabic language and means "to make marks like a magician." Indeed, that is what a talisman is, an extension of magic, an item that contains magic power.

A talisman can be made from almost anything, although it is most commonly designed as a medallion, necklace, mantle, pin, charm, small statue, headdress, or hand-held symbol. A talisman is designed to perform one function only. The invocation enables the sorcerer to empower an ordinary object with magic powers. The only substances which cannot be used are iron and plastic, and the object cannot be larger than two feet (0.6 m) tall, long or wide. Once an object is transformed into a talisman, the sorcerer can empower it with one magic spell. The spell can be selected from levels one through eight, excluding illusion types. Of course, to implant the spell the sorcerer must already know it and it must be a spell invocation, not a ritual.

After its initial creation, the talisman can be used to cast its one spell for a total of three times. After all three have been cast, the object is drained. The mystic who created the talisman can replace its three exhausted spells by casting that same spell invocation combined with part of the talisman spell or ritual. The cost of the recharge is 50 P.P.E. plus the cost of the spell invocation. Note that the process must be repeated for each of the three identical spells (each at the cost of 50 P.P.E. plus the spell's P.P.E. cost). Thus, to recharge all three identical spells would cost 150 P.P.E. points plus the spells P.P.E. costs. The aspect of three spells attributed to magic items may be the source of legends that grant three wishes.

A talisman can be used for one purpose other than spells. The mage can elect to make it a potential psychic energy battery. Instead of spells, the mystic can put up to 50 P.P.E. into it initially and recharge it with 30 P.P.E. at the cost of 60. The talisman can then be used at a later time to bolster the character's normal P.P.E. reserve. A P.P.E. battery can never hold spells.

A talisman can be destroyed by smashing it. That's all there is to it. If the arcanist who created it is killed or cannot be found, the talisman will be good for whatever number of spells that are currently inside it, and cannot be recharged. Remember, only the mage who created it can recharge it.



LEVEL FOURTEEN

Close Rift

Range: 100 feet (30.5 m)

Duration: Instant

Saving Throw: Standard.

P.P.E.: 200 plus 2 P.P.E. from the character's permanent P.P.E. base!

The master of magic can close a Rift by sheer force of will. However, the monumental effort permanently drains the mage of two P.P.E. points from his permanent base whether successful or not. The mystic nature of the dimensional gateway gives it an automatic save versus magic attack. Consequently a Close Rift Ritual will increase one's odds for success. The Rift will automatically vanish if successful. A failure means the Rift is not affected and the wizard has lost 2 P.P.E. forever.

Id Barrier

Range: Up to 200 ft (61.0 m) away, plus 100 ft (30.5 m) per level of experience.

Duration: 3 minutes per level of experience.

Saving Throw: Standard, and vs horror factor.

P.P.E.: 600

The character can erect a powerful, defensive shield of semi-transparent energy. The barrier itself emanates horror, and a character must save vs horror factor 14 to even come within 10 ft of it. Those who fail to save vs horror factor cannot pass through the barrier.

Anybody who braves the barrier must roll again, this time to save vs magic. A successful save means the character passes through the barrier with only a headache and loses on attack that melee. A failed save means the character must face an apparition of his greatest fear. The apparition is exactly like the sixth level invocation and will last as long as the barrier remains up. Only

the mage who created the Id Barrier can make the apparition vanish, or cancel the barrier before its normal duration time.

Restoration

Range: Touch or 3 ft away (0.9 m).

Duration: Instant and permanent.

Saving Throw: None.

P.P.E.: 750

This powerful incantation will instantly and completely heal wounds, cuts, bruises, burns, etc., restoring full S.D.C. and hit points, while leaving minimal scarring. It is so powerful a magic that it can heal internal organs and mend bones. Even bullets or shrapnel will magically disappear and the wounds heal. The invocation can also restore severed limbs, such as a hand, arm, or leg, providing that the limb has not been severed from its body for more than 48 hours. Substitute limbs and organs cannot be used. Nor can this invocation restore life or replace missing limbs or organs.

LEVEL FIFTEEN

Dimensional Portal

Range: A few feet away.

Duration: 30 seconds (2 melees) per level of the spell caster, or one minute per level of experience when performed as a ritual.

Saving Throw: None.

P.P.E.: 1000

The dimensional portal invocation opens a two-way door to another dimension. The mage can open a door to a specific world or randomly. This is the only way a greater being can enter into our dimension. Once the dimensional portal closes, the only way back in or out is to open another portal. One of the real dangers of using this magic is that some unwanted "thing" always slips through.

Teleport: Superior

Range: Self or others; distance of 300 miles (480 km) per level of experience.

Duration: Instant

Saving Throw: None

P.P.E.: 600

The sorcerer can instantly transport himself and up to 1000 lbs (450 kg) per level of experience, hundreds of miles away. To teleport, the mage must have a mental picture of his destination. The best results can be achieved when the character is personally acquainted with the target destination, some place he has visited or knows well. However, locations seen in photographs or described in detail can also be reached, but there is always a chance of a miscalculation.

The mage can teleport himself alone, or other people and objects within 20 ft (6.1 m) of him. The total number of people and items which the mystic can teleport is limited by the amount of weight he can handle (1000 lbs/450 kg per level of experience).

The following tables indicate the chance of a success and the results of a failed teleport.

Chances of a Successful Teleport

1. Teleporting to a familiar location or a destination visible from one's starting point: 99%

2. A place seen only a few times before (2-6 times): 85%

3. A place seen in a photo (the photograph is being looked at during the moment of teleportation): 80%.

4. A place never seen before, but described in detail: 58%.

5. A place never before visited and known only by name or brief description: 20%.

Results of an Unsuccessful Teleport

1-40% Appear at the wrong place. No idea of present location, 3D6 x 100 miles (480 to 2900 km) off course.

41-75% Appear at the wrong place. No idea of present location, 1D6 x 100 miles (160 to 960 km) off course.

76-98% Teleport several feet above the ground; everybody falls, suffering 2D6 damage.

99-00% Teleport into an object; instant death.

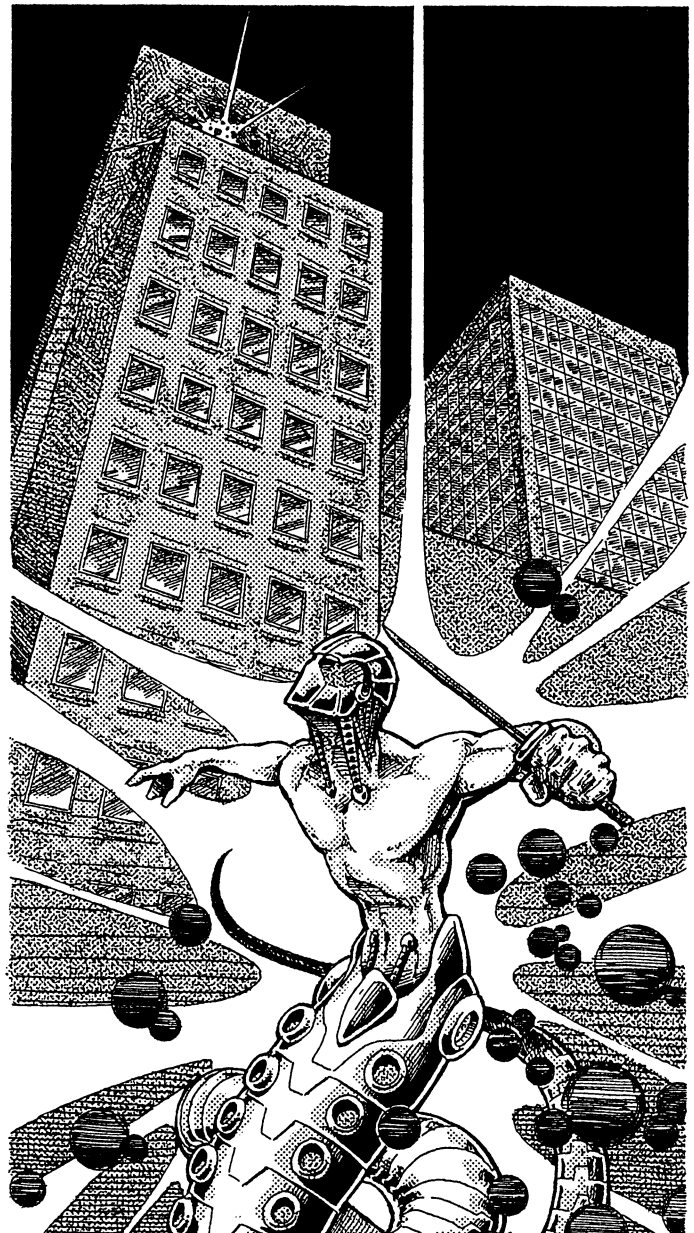

Life After Dark

The Earth has been invaded, but most people don't know it. For the average person, life goes on *almost* as it always did. People go to work, pay their taxes, and return home to their families. However, in this new world After Dark, every day, a few people fail to return to their homes. Some simply vanish. Others fall victim to the soaring crime rate. Sometimes, a person comes home to find people who look like his or her loved ones or friends, but who act strangely different. And occasionally, Joe Average sees something that he was never meant to see — a sinister shadow of something not quite human or a strange reflection in a mirror. There is a growing feeling that humankind is no longer in control of its own destiny. That people are becoming more like cattle to be herded and corralled for some unknown purpose. A handful of free-spirits rebel against this prevailing sense of loss and dark secrets. They abandon their normal lives to uncover and fight the forces behind these troubling changes. The rest? They try to ignore the danger and cling hopelessly to the shrinking illusion of normalcy.

For the Nightbane, life after Dark Day is a struggle for survival. They can reach two worlds, Earth and the Nightlands, but can never fully call either one home. Some abandon their ties with humankind, and consider only other Nightbane to be their peers. Others try to balance their human and alien sides as best they can.

Described below is the world of Nightbane — the Earth after the Dark Day Invasion, and the Nightlands.

Earth After Dark

Earth has special significance for the Nightbane. In all the ways that count, Earth is their home. Despite their inhuman shapes, Nightbane have a better chance of being accepted among humankind than in the Nightlords' domains. Having grown up among humans, their memories and personalities are "normal" (or as normal as humans can be). The Nightbane might be refugees from the Nightlands (their true origin and roots are a mystery), but it is not a home or haven of any kind. If they return, they will be hunted down without mercy. And now Earth is in danger of becoming an extension of the Nightlands — if the Nightlords win, there will be nowhere to run.

The Earth of the early 21st Century is very similar to our own, but is much shabbier, poorer, and darker. Technology, after advancing by leaps and bounds for decades, has slowed down noticeably in the years following Dark Day. The economy has gone to hell, with people too scared and worried about the future to spend their hard-earned money. Crime is on the rise, a trend that started with Dark Day and continues as both the Nightlords' minions and normally frustrated, terrified or greedy humans prey on the populace. At the same time, laws have become harsher and less fair. To the man (and woman) on the street, neither the government nor his next door neighbors are to be trusted. Every-

body has a horror story to tell, from a terrible crime that befell a relative to a supernatural experience the victim can barely comprehend.

The average person believes in the existence of Nightbane (the name has come out, and several tabloid magazines use it frequently). These "monsters" are believed to be dangerous mutations, extraterrestrials or even demons. Many people, especially scientists, "respectable" professionals and the educated, believe these tales to be urban myths and superstition. Almost nobody suspects the existence of the Nightlords, Dopplegangers, or the organized invasion and infiltration of all the governments. Those who do suspect (or know), are dismissed as "conspiracy theorists" and crackpots.

The most important changes since the end of the 20th century (at least on the outside) have been the rise of the Preserver Party, the stricter laws passed since the Preservers won the Presidency, and the increase in crime, superstition, and fear. All Federal agencies have been consolidated into one monolithic organization, the *National Security Bureau (NSB)*; an agency used to terrorize dissidents and hunt down the so-called Nightbane and other rebels (most NSB agents are not human and serve the Nightlords).

The Preserver Party

Dominating affairs in the U.S. is the now-infamous Preserver Party. Founded in the last years of the 20th century by conservatives and traditionalists, this small party managed to capture only a tiny percentage of the electorate in the years before the 2000 election. The party seemed fated to be nothing more than a footnote in political history books — until the Nightlords found them. Dopplegangers, Hollow Men and Avatars of the Nightlords replaced the leadership of the party. Millions of dollars in funds were suddenly available and enabled the Preserver candidates to buy entire slots of television time. This tactic soon made the Preserver Party a household name and garnered them the public recognition they coveted.

The Preservers' platform was a mishmash of often contradictory ideas. It mixed environmentalism with anti-crime measures and a return to "good old American traditions." Even before Dark Day, their simple message attracted certain people. They even started making their presence felt in high schools, where they sponsored the Young Preservers club. Young Preservers were typically nice, clean-cut boys and girls who became involved in charitable activities and preached against sex, drugs and "evil music." The group also became active in "crime watch" organizations, forming unarmed groups that walked the streets equipped with police radios to monitor growing criminal activity.

Meanwhile, the adult Preservers pressed for stricter laws, the increase of police powers, and harsher punishments for con-

victed criminals. "There should be ten thousand executions a year in the United States, not less than a hundred," Preserver spokesman Douglas Carson (now the President of the U.S.), once said during a televised interview. "Only then will we be able to control crime." According to Carson and his cronies, the mainstream parties would never do anything decisive because they had been controlled by special interests and no longer cared about the fate of the country. The message appealed to many frustrated Americans.

Dark Day strengthened the movement. The current government did not handle the situation very well (although it is hard to imagine anybody doing better under the circumstances). The Preservers denounced and criticized every action the government took, which increased their visibility and popularity even more. At the same time, agents of the Nightlords manufactured a number of scandals affecting the leading candidates of both the Republican and Democratic parties. One of the candidates even committed suicide after allegations of links to organized crime became public.

The Preservers won the presidential race with a slim margin. Political analysts predicted that gridlock would prevail, because Congress was roughly divided into three equal portions, each belonging to one of the parties. Instead, most members of Congress came to agree with President Carson's policies and initiatives. This was possible thanks to bribes, blackmail, threats and the outright replacement of many members of Congress with supernatural minions. By late 2001, the U.S. government was firmly under the control of the Preservers and their true masters, the Nightlords.

The Young Preservers started forming Preserver Activist Groups. These volunteer organizations were created to "fight crime in the community" and originally seemed to be little more than a crime-watcher group. Later on however, the Activists were allowed to carry weapons and were formally "deputized" by the Federal government and local police offices. By 2003, they were a paramilitary force often used to intimidate people who opposed or worked against the policies of the U.S. government. These gangs of thugs are often led by Dopplegangers and Hollow Men, although most members are humans who enjoy the power to bully the weak and defenseless.

Law Enforcement & Crime

Under the Preservers, civil rights have been trampled in the name of law and order. Not only was Congress been subverted and infiltrated, but hundreds of judges and Court Justices have fallen under the Nightlords sway. The police and federal agencies (led by the **National Security Bureau**) have been given broad rights to search and seize houses and properties. As long as a cop has probable cause, he can kick down a door and search the premises. Probable cause has been stretched to the point that as long as the police officer says something like "I got a funny feeling about that place," the results of the search will be allowed. Many innocent people have been held at gunpoint while their homes and apartments were torn apart in the search for drugs or illegal weapons. People who complain too loudly about the government are often singled out for this treatment.

Gun control was another part of the Preserver agenda. Although at first, the Preservers enjoyed the support of many conservative anti-gun control proponents, they made a quick shift

once they were in power. **The National Gun Registration Act** was passed in 2002, forcing all gun owners to register their weapons, including rifles and shotguns. This act was coupled with the **Dangerous Armament Control Act**, which outlawed hundreds of guns, from semi-automatic pistols to many high-caliber hunting rifles, unless the owner could acquire a special permit to own them. These permits seemed to be refused to most gun owners, with the exception of supporters of the Preserver Party and members of the **Preserver Activists**. The result was a



largely unarmed and defenseless America. Many gun owners refused to comply with the law, hiding their weapons or even going underground themselves. Many of these, especially members of the NRA, survivalists, militia members and members of similar groups, have joined underground resistance groups, sometimes allied with the Spook Squad or even some Nightbane Factions.

Other laws also became much harsher, both at the national and state levels. The parole process became strict and difficult. Appeals were also reduced (in some cases, eliminated). The executions of convicted criminals have become commonplace throughout the country. Two years after the Carson election, every state in the Union, except Hawaii, had passed death penalty laws and were quickly (some would say savagely) implemented them. Rumors about torture, monsters, strange experiments, massacres and disappearances inside prisons also abounded, but the press hasn't been able to get any proof to substantiate these allegations — or, more accurately, the few reporters who manage to get “inside” have disappeared themselves! In truth, many convicts are now serving out their terms in the Nightlands, working as slave labor or worse (see the **Nightlands Section**).

Under the guise of remaking a system that “coddled the criminal and left the victim to suffer,” the laws in the U.S. have become tyrannical and repressive. Corruption and favoritism are rampant, and people with the right connections can literally get away with murder. Since most people still aren't directly affected by these laws, they haven't reacted strongly against them. The government claims that crime figures are down, but shootings, gang warfare, murders and kidnappings seem more commonplace than ever before. Minor crime has been controlled by these savage measures, but overall, the streets of the 21st Century remain very dangerous. Especially at night.

The Police

In the weeks preceding and following Dark Day, the Nightlords' minions have systematically seized controlled of, or replaced many Police Chiefs across the country. Currently, about 13% of all police officers in every department are *not* human! They have been replaced by the minions of the Nightlords that have the power to disguise or alter their appearance, or with Doppelgangers, the strange doubles of humans who dwell in the Nightlands. Additionally, many (30%) police officers have been replaced by greedy, bullying and corrupt cops who will obey any orders, no matter how illegal or evil, provided it benefits them in some way.

This infiltration of America's law enforcement agencies has been a critical and strategic necessity. After all, these are the front-line “street” troops who see first hand the horrors that stalk our streets and citizens. It had been police officers who first caught a glimpse of the inhuman creatures and suspicious activities of the Darklords' minions and pawns. Respected and empowered, they could strike a serious blow to the Darklords' plans of quiet conquest. Thus they had to be the first to be undermined, corrupted, and controlled. Those who learn too much and cannot be corrupted, are eliminated from the police force, one way or another. Consequently, many dedicated police officers have left (or been forced out of) service and have become vigilantes, independent operators, created secret civil defense or-

ganizations, their own investigative groups, or have joined the Spook Squad (see the **Nightbane Factions**), and other underground groups. Others have discovered they possess strange powers which have surfaced inside them since Dark Day. They are Nightbane or psychics determined to find the truth, or at least some answers.

By 2004, most people no longer trusted the police. “If you are in trouble, for God's sake don't call 911;” this message is spray-painted on city walls across the nation. Both criminals and normal citizens are terrified of the police. On the other hand, their brutality has managed to reduce the incidence of petty crime, assaults and robberies, so many citizens accept them as a necessary evil, or rather not face the grim truth.

Note: Only 2% of the U.S. military has been infiltrated or corrupted by the denizens of darkness. However, the military is effectively “cut out of the loop,” and (presently) have little influence on civilian matters. Furthermore, there is discussion about reducing the size of the military and numerous military contracts have already been cancelled. Some armies in other parts of the world (especially among third world nations where slaughter is believed to be the handiwork of savage rival factions) have been “reduced” through nighttime seek and destroy missions at the hands of Hounds, Hound Masters and Hunters.

The NSB

The National Security Bureau was created by the government to replace most Federal law-enforcement agencies. The alleged idea was to create a more “efficient” central force that would not be hampered by inter-agency squabbles and failures to cooperate. In reality, the NSB is the tool of the Nightlords and the initials actually stand for the *Nightlords' Society of Blood!* 70% of all NSB field agents are Doppelgangers, Hollow Men, or Squires (see the **Nightlands Section** for more information). These inhuman creatures are very well trained to fit into 21st Century Earth and use its weapons and technology for maximum effect.

In theory, the NSB only has jurisdiction over crimes committed across state lines, and a number of Federal crimes (including crimes involving or affecting the Federal government), and kidnappings, which are usually assumed to be an interstate crime. It is also in charge of intelligence gathering outside the U.S., replacing the CIA in this respect. In reality, the NSB acts as the secret police of the Nightlords and is free to do as it pleases, a job made all the easier thanks to the Nightlords' control of most law-enforcement agencies throughout the world. There is one major limiting factor, however. The NSB is under the control of the Nightlords' High King, Moloch (see the **Nightlands Section** for more information about Moloch, his partners and allies). The other Nightlords resent Moloch, and even if they aren't plotting against him (and many are), they sometimes interfere with NSB investigations to spite him.

The most dangerous NSB sub-agency is the **Hostage Rescue Team (HRT)**, patterned after the FBI's team of the same name. These alleged “hostage rescuers” have yet to save any hostage that was not a secret member or servant of their society, but they have killed over two hundred innocent people and over 1100 alleged terrorists and conspirators in the years since their appointment. The HRT is a paramilitary team with the best weapons and armor available. They are often used to attack Nightbane gatherings under the guise of “combating terrorists.”



Street Gangs

A problem for almost two centuries, street gangs have become a power to be reckoned with in the 21st Century. The drug trade continues unabated and gives gangs more money than the entire budget of a local police precinct. Harsh anti-drug laws have only made the trade all the more profitable. Dark Day and the takeover of the world's governments have changed a few things in the gangs, but they continue to be a power in the slums of most major cities in the United States.

At the time of Dark Day, the most powerful and influential gang was the **Golden Posse (GP)**, which grew out of the union of three of the largest nationwide gangs in the country. The GP not only had control over the streets, it used its money to bankroll a number of city and state-level politicians who took care of protecting the gang's interests. The Posse also started recruiting ex-military members into the gang, using them to train and discipline their "soldiers." In some ways, the GP had become the equivalent of the Mafia in the 1940s, running entire cities.

The invasion changed much of this. Many of the Golden Posse's pet politicians were killed, replaced with doubles, or "convinced" to switch allegiances to the Preserver Party. The controlled police and Federal law enforcement agencies then declared war on the gangs. Thousands of Posse members have been arrested (and hundreds of those have disappeared in prison) or have been killed in savage gunfights between the gangs and the police. At the same time, a group of street-bred Nightbane (many of whom had been members of the Posse) have formed their own gang, the **Warlords**. The cities have become a savage

three-way battleground between the Nightlord controlled police, the Warlords, and the Golden Posse. Every day there is at least one gang-related murder in any given city. This doesn't even include the hundreds of tiny or fledgling street-gangs scattered throughout the cities of the nation.

Technology

The 21st Century was seen by many as a time of great technological breakthroughs. A century in which humankind would conquer space, circle the world with a global information network, and produce all kinds of medical and electronic wonders. Instead, people look longingly back at "the good old days" and see the new century as a nightmare they must endure. The number of new products and developments has dropped off dramatically. The chaos of Dark Day (and subsequent influence of the Darklords) has harmed the economy and caused technology to stagnate compared to the previous decade. Furthermore, the strange phenomena caused by the invasion and resulting upheaval has made a lot of people fearful of anything new or different. They long for stability, familiarity, and to maintain the status quo. For the most part, anything that is common or "new" in the 1990s will be still commonplace in this new era.

Computers & the Internet

The average home computer in the 21st Century is faster, more complex and has more capacity than anything that could fit on top of a desk five years before. Almost everybody who can afford a television has a computer; they have become a common home appliance. Some computers are a combination television, telephone (and vidphone), and answering machine in addition to its normal computer uses. Computer-linked videophones (with images as well as sound) are slowly becoming commonplace, although for the most part, they remain a novelty and something of a luxury.

The giant network of computer services has become larger and slightly more standardized in the early years of the 21st Century. Progress has been hampered by the efforts of the Nightlord-controlled governments to fight "computer crime" and limit the "freedoms" of the 'net. Still, a lot of information is floating around the information superhighway. In fact, many underground groups use the 'net as a communication node, often sending encrypted information or setting up secret bulletin boards hidden "beneath" apparently harmless net services. For example, to connect to Freedom, the Resistance bulletin board, Resistance members have to log onto the *New Gladiators Electronic Fanzine* service, and then type a series of passwords at selected locations (the passwords are changed regularly). Shortly afterwards, they are granted access to the secret BBS (Bulletin Board Service). In these "black BBSs," members of the Nightbane Factions exchange news and information, and also request aid from fellow members. Whole adventures can get started with BBS messages like, "Besieged in CT need help," in which a Nightbane cell in Connecticut is about to be overwhelmed by NSB agents and needs help to escape. If the player characters live nearby, they might volunteer.

The Nightlands

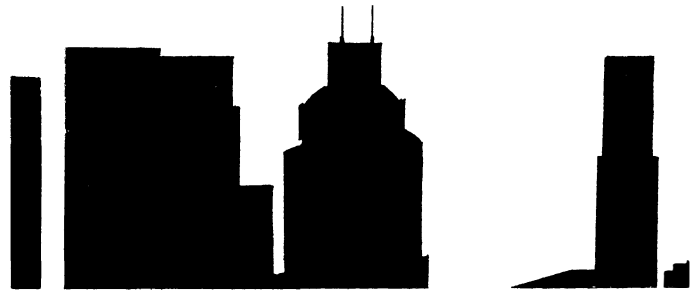

The first thing I saw was the pitch-black sky, looming over the world like a doorless vault. Down below was an angry red desert, and protruding over the horizon were jagged towers and gothic skyscrapers, black and yet visible against the ebony sky. Bat-winged things flew between them, carrying out tasks for their dark masters. In the distance, I heard a scream of pure anguish echoing through the old towers. It was answered by a triumphant roar.

"Welcome to Wonderland," said Burger-face.

"Welcome to Hell is more like it," I replied.

An army was pouring out of the distant city. A forest of spears moved at a steady pace, carried by a host of Hounds. Banners of human skulls were raised high and a steady drumming marked the march. Among the infantrymen I saw lumbering Battle-wagons spewing smoke and hellfire as they advanced.

"Where are they going?" I asked.

"Oh, to attack one of their neighbors, I suppose," Burger-face replied. "Just because they're conquering the Earth doesn't mean they don't have unfinished business here."

"Maybe that's good."

Burger-face looked at the spreading horde, more Hounds than I had thought existed, marching steadily to war.

"Maybe."

Earth is not the only battleground in the war between the Nightlords and the Nightbane. There is an entire world on the other side of every mirror; a nightmarish reflection of our reality. In the Nightlands, monsters rule and life is short and brutish. Here lies the source of the enemy's power. However, to strike at the Nightlands is to strike at the heart of the Nightlords. To complicate matters, this savage land might just be the home of the Nightbane, horrible as that thought may be. Some Nightbane claim it as their own and have managed to live, hiding in the dark cities, or in small sanctuaries in the desert Waste that stretches beyond the cities like an endless ocean of dust.

The Land

The skies of the Nightlands are a sheet of solid darkness, disturbingly similar to the skies of Earth during Dark Day. It is a black expanse without moon or stars. Despite this, even normal humans can see unaided in this world as if it were twilight. Where this strange illumination comes from is a mystery. The only places that are solid black and imperceptible to humans are places where shadows are cast (Perception rolls to see into a shadowed area are at -5 for people without nightvision). Strangely enough, structures cast shadows, despite the fact that no apparent source of light is visible in the skies or from the surface. Some students of the Nightlands speak of a "black sun" or some invisible body that still somehow casts light from the dark skies, but most regard such talk as myth or foolishness.

There are no oceans in the Nightlands. Only three types of terrain exist in this world: jagged mountains, flat plateaus, and desert-like plains of red sand and black rocks. There is no rainfall and water evaporates very slowly. The temperature is cool and consistent throughout the land, always staying between 45 and 50 degrees Fahrenheit, unaffected by height and proximity to the Equator. Winds come and go without warning and are frequently near hurricane force. Across the desert plains, tornadoes are not uncommon. The meteorological phenomena do not seem to obey any of the causes and effects known on Earth. Some occultists believe they are brought by random dimensional Rifts that open to others worlds; other think they are the result of magic or elemental activity.

The desert plains are collectively known as the Waste. Small rivers and lakes dot the Waste. They seem to spring from nowhere and disappear after a few miles, yet they have a constant flow of fresh (and sometimes salt) water. Some of these rivers and lakes have Earth fish swimming in them! Others are the home of alien animals or monsters. Again, they are believed to come through random gateways linked to other dimensions. Given access to water, some Earth plants can actually grow and survive in the red earth of the Nightlands, in total disregard of natural laws (they shouldn't grow well in constant darkness). Since most denizens of the Nightlands do not need to eat and drink to survive (at least not as normal beings do), it is not important to them.

One of the strangest qualities of the Nightlands is the fact that anybody (human or Nightbane) who finds himself in this land will be able to understand (and read, if he was literate in any language) the native language of the Nightlands, known as *Darktongue*. Darktongue has some elements in common with Latin and other Romance languages (like French, Spanish and Italian), but it is a completely different language with many strange grammatical twists. This capacity to understand the alien tongue applies only when in the Nightlands and stops when the visitor has left, fled or escaped the twilight world. A few scholars have managed to learn the language independently, making it a very rare skill to find.

The City-States

Some of the most impressive sights in the Nightlands include the great cities that dominate the landscape. These cities always correspond to the location of existing Earth cities, but are held as independent city-states under the dominion of a Nightlord or one of his minions. One theory claims that the denizens of the Nightlands are attracted to the P.P.E. energies emitted by large concentrations of humans on Earth; this is why they flock to wherever humans are found. They grow as their Earth counterparts grow, and even acquire some superficial resemblance to them. For example, New York City's Nightland counterpart has

a roughly similar skyline. At first sight, the Empire State Building and the World Trade Center might appear to be there. A closer examination would reveal that this world's Empire State Building is a tower with narrow arrow slits instead of windows, and that the World Trade Center buildings are made with black stones, with bars in the windows and sculpted gargoyles perching menacingly on every level.

The differences become more apparent upon closer examination. Streets and smaller buildings rarely match those on Earth. The streets are paved with cobblestones and are meant to accommodate carriages rather than cars. Streetlights are powered by magical glowstones that shine with weak yellow or red light. People can be seen walking around, dressed like normal people on Earth, but they don't seem to be in much of a hurry. In fact, they look more like sleepwalkers than regular pedestrians. If they hear any loud noise, they instinctively cringe, but make little effort to hide or run. These aren't real people, but Doppelgangers, supernatural doubles of the humans living in the city-state's Earthly counterpart.

There are also far less people inhabiting the city-states than on their Earth equivalents. A few occultists have studied them and estimate that, although they have roughly the same land area as a city on Earth, most city-states have between one-quarter and one-fifth of the city's population. Most (86%) of those inhabitants are Doppelgangers, with the rest being Hounds and Hunters (roughly 8%), and other supernatural beings, including the Ash-medai and Hollow Men (less than 1% each).

Occasionally, a carriage rushes down the street. Instead of horses, most of these carriages have humans or Doppelgangers

harnessed to pull it along! A Hound typically drives the carriage, encouraging the "mounts" with a whip, conveying a Nightlord or some other important minion to a meeting. Flying Hunters sometimes pluck a random victim off the streets, or a bored Hound will spear a passerby for no other reason than for some quick amusement. After a moment of terror, the rest of the Doppelgangers go back to what they were doing before, moving like drugged or entranced men and women.

Nightbane wearing their Facade can hide in plain sight in these cities, provided they show little emotion and move like zombies. The auras of the thousands of Doppelgangers in the cities act as a damper to the Hounds' supernatural sense of "smell," and it is possible to hide and even live in the cities for a long time without causing suspicion. It is reputed that dozens or even hundreds of Nightbane, humans and rebellious Doppelgangers have formed underground movements in many Nightland cities. They are helped by the fact that the sprawling cities are half-empty; many buildings and towers stand abandoned, or used by beggars and scavengers.

There are comparatively few humans in these cities. They are for the most part, valuable slaves of the **Nightlords** or the **Night Princes**. The Ba'al enjoy torturing all beings; Doppelgangers are the typical "pleasure slaves," but humans seem to be "tastier" to the Nightlords' psychic senses. With the invasion of Earth, the number of human slaves has increased tenfold. Many have become domestic and pleasure slaves, while others are forced to work in chain gangs, building roads across the Waste or fixing old buildings.



Besides humans and the “natives” of the Nightlands, there are other inhabitants in the cities. Occasional bands of vampires, entities from other dimensions, and other supernatural beings hide among the many empty buildings, sometimes preying on the Dopplegangers and other minions. Some come out of hiding to become valuable allies or servants to the Nightlords. Even a few animals, mostly rats, have managed to survive in the City-States, but for the most part, the streets are as lifeless as the Waste.

Each City-State is under the control of a Nightlord, either directly or through a powerful servant. While most Nightlords acknowledge Moloch as their overlord, each has a free reign in the management of their own domain. Besides Moloch, the most powerful Nightlords usually rule over as many as a hundred cities of varying size. Conflicts between cities are frequent. Before the invasion of Earth, wars raged between half a dozen cities. Thousands of Hounds, Hunters and Dopplegangers fought and died on red-sand battlefields. Occasionally, a Nightlord was destroyed, or, more often, he would lose his power over a City-State and be forced to enter the service of a more powerful Ba'al.

Even after the invasion, conflict and intrigue are still common in the Nightlands. Many Nightlords have been left out of the great conquest and they are either resentful or wondering if now is the time to make their move, while their more powerful neighbors are distracted with problems on Earth. Unfortunately, so far, these minor skirmishes have done little to undermine the power of the Nightlords.

The Waste

Surrounding the cities lies the Waste, a barren ocean of red sand and jagged, black rocks. A few paved roads cut into the Waste and link the cities of the Nightlords, but most of the area is left alone. Maybe this is because the Nightlords have no interest in the Waste, or perhaps because they fear what creatures may dwell there. The wind-swept desert is beset by dimensional Rifts and other anomalies. Some of these Rifts open to Earth, sweeping up animals, plants and humans, and deposit them here. Most of these castaways die in the hostile new world, but a few survive, living close to the few rivers and lakes that can be found there. Small human communities, some from long-lost cultures, eke out a meager existence here. They are frequently preyed upon by monsters and sometimes fight each other. Most of these communities are village-sized, although there are rumors about the existence of a few human and Doppleganger towns.

Traveling in the Waste is hard and hazardous. Although the temperatures are generally cooler than those in Earth deserts, there is still very little food and water available. Although the land is flat, it is broken terrain, exhausting to walkers and damaging to normal vehicles. Some Nightbane and human sorcerers have used magic to transport cars, jeeps and trucks (and, it is rumored, several military vehicles) into the Nightlands, and use them to travel the Waste. As long as they stay away from the main roads and do not stumble into a flying patrol, these travelers are relatively safe from the Nightlords' minions. That does not protect them from the many other creatures that prowl the Waste (some of those creatures are described later in this section).

The Nightlords' slaves have built a large network of roads linking all the major City-States. They are wide and solid roads designed to transport huge marching armies from one place to the next. Fortunately, these roads are the only places in the Waste that are regularly patrolled by the minions of the Ba'al.

Long mountain chains split apart sections of the Waste. Most of these rocky mountains are extremely sharp and steep, and as challenging as the toughest climbing spots on Earth. Except for a few narrow passes, it is very difficult to traverse these mountains. The Nightlords avoid that problem by relying on Hunter-pulled chariots or other magical flying machines (it is rumored that a couple of Nightlords have brought small aircraft from Earth and now use them as their “winged chariots”). Their land-bound minions typically avoid the mountains. As a result, a lot of refugees, monsters and transdimensional creatures have flocked to the jagged mountain ranges, and use them as relatively safe havens. The *Nightbane Underground Railroad* has built about a dozen Havens in those mountain ranges, keeping them supplied from Earth. A couple of those Havens have been taken over by the Resistance (one of them violently, although resulting in no deaths) and are now used as staging points for raids against the Nightlords.

Crossing Over

There are several ways to enter the Nightlands. Dimensional Rifts at ley lines, nexus points and dimensional zones such as the Bermuda Triangle (see the **Magic Section** for more information), can whisk Earth people into the lands of night without warning. Some magical rituals also allow for passage between the two worlds. *Nightbane* need neither magic nor accidents to reach the Nightlands. They can *cross* into the twilight world simply by stepping through a mirror! As the Nightbane concentrates, the surface of the mirror turns into a reflective black, then opens up into a vista on the “other side,” the part of the Nightlands that corresponds to the mirror position on Earth. Then the Nightbane turns into black light and pours himself through the mirror, no matter how small. This power has given rise to the term “Mirrorwall” to refer to the separation between the two worlds. The Nightlords and a few of their minions (especially the Hounds) can also cross over through mirrors.

Many students of the occult have wondered about the significance of this ability. Maybe it is an inherent magical power enabling the Nightbane to open a dimensional portal, using the mirror as a focus. Or perhaps the Nightbane are actually beings of pure energy, able to cross between dimensions like a fish swimming through water. The Nightlands are often called a “twisted image” of Earth. Maybe the comparison is literal, and the Nightlands are actually a dark counterpart to Earth, and the mirrors somehow act as portals to that other reality.



Denizens of the NightlandsTM

Described below are some of the most common denizens of the Nightlands. More of the bizarre inhabitants of this world will be described in future supplements. Game masters may also wish to introduce other supernatural beings described in **Beyond the Supernatural**, **Rifts**, **Wormwood** or other RPGs and sourcebooks. Characters and creatures from **Beyond the Supernatural** can be brought into **Nightbane** without need for any conversions or modifications, others, particularly those with *mega-damage* settings, will require some modification.

Doppelganger R.C.C.

Optional Player Character

The most common denizens of the Nightlands are Doppelgangers who look *exactly* like normal humans, although slightly paler. More extraordinarily, they look exactly like specific people living on Earth! Millions of people on Earth have an exact double living in the Nightlands!! The exact proportion is not certain, but some students of the Nightlands believe that between twenty and thirty percent of all adult humans have a Doppelganger. Children and pre-teen Doppelgangers also exist, but they are very rare, accounting for less than two percent of the population.

The similarities go beyond physical appearance. Doppelgangers know most of what their human doubles know. Their skills, abilities and capabilities correspond almost exactly with their counterparts' knowledge. Even their personalities (and alignment) are somewhat related, although some Doppelgangers tend to have a twisted version of their doubles' personality, exhibiting the worst traits, including many that are typically repressed or buried in the normal person's psyche. Many Doppelgangers are the exact opposite of their doubles (this means that some Doppelgangers of evil people will actually be moral, decent beings). Others are completely similar, both physically and mentally.

So where do the Doppelgangers come from? The few parapsychologists who have become aware of these creatures' existence have dozens of possible theories. The Doppelgangers might be creatures of psychic energy who somehow "capture" a human being's thoughts and make them flesh. Or they could be living counterparts of Earthlings just like the Nightlands may be the counterpart of Earth — an alternate Earth. Occultists aware of the legends of the *Formless Ones*, speculate that these beings were given human form by the Nightlords, who magically created a race of pseudo-humans using living people as "models."

Beyond their appearance and personality, some of the other traits of the Doppelgangers further confuse those who try to understand them. For example, if a Doppelganger manages to cross over to Earth, he will die in less than two days unless his double is killed or one of them (human or Doppelganger) goes back to the Nightlands. The legends dealing with doubles and how meeting them would mean the death of one or the other, are dead

accurate. To live on Earth, away from their hellish existence, a Doppelganger's double must die. A few fortunate Doppelgangers have managed to cross over after their double was killed in an accident or some other "natural" cause. However, in most cases, the Doppelganger seeks out his double, murders him or her, and takes their place.

Doppelgangers are not born or created; they seem to manifest spontaneously in the Nightlands, usually at some point in their double's youth or early adult life. The Doppelganger then ages at the same rate as their human double. However, if the human double dies or is slain, the Doppelganger is frozen at the age of their demise and lives for as long as a century without growing older. Most Doppelgangers in the Nightlands are in a permanent state of daze, seemingly unaware of their nature and their abilities. Their lives in the Nightlands are nightmarish mockeries of the lives of their doubles. The creatures get up every "morning" and go to work, eat, and play. They are constantly victimized and bullied by the more powerful and independent dwellers of the Nightlands. Sometimes, Hunters and other predators use Doppelgangers for "target practice" before transferring to Earth to kill their human doubles. The fact that the mortality rate among Doppelgangers is higher than among humans might explain why only one-third to one-fifth of all Earth adults have a living double in the Nightlands.

When the Nightlords need the services of a Doppelganger, the unfortunate is brought before them and "awakened" through psionic stimulation and torture. Awakened Doppelgangers realize who and what they are and are filled with an urge to go to Earth, which they regard as a heavenly world where they can find happiness. Many of them will gladly serve the Nightlords for a chance of living in the "World of Light," as they call Earth, even for a short while. Most awakened Doppelgangers feel a combination of jealous hatred and envy towards their doubles, and will happily murder them.

Once in a while, Doppelgangers awaken spontaneously. Several different circumstances can bring about this event. Sometimes, the death of their Earth double will create a form of psychic backlash that will snap the Doppelganger out of his daze. Being brought to Earth (usually by accidentally being swept up by a dimensional anomaly) will automatically awaken the Doppelganger — who will realize he has 48 hours to either return to his world or replace his double if he is to survive.

Not all Doppelgangers are evil monsters. Many who awaken decide to oppose the Nightlords and either form underground movements in the City-States or sometimes join forces with **Nightbane** and other enemies of the Ba'al on Earth or in the Nightlands. Not all awakened Doppelgangers feel compelled to go to Earth and slay their counterpart (or they can control these urges). An awakened Doppelganger can live in the Nightlands indefinitely without killing his human mirror image on Earth. Likewise, if the Doppelganger travels to Earth and his human counterpart travels to the Nightlands, both can continue to exist

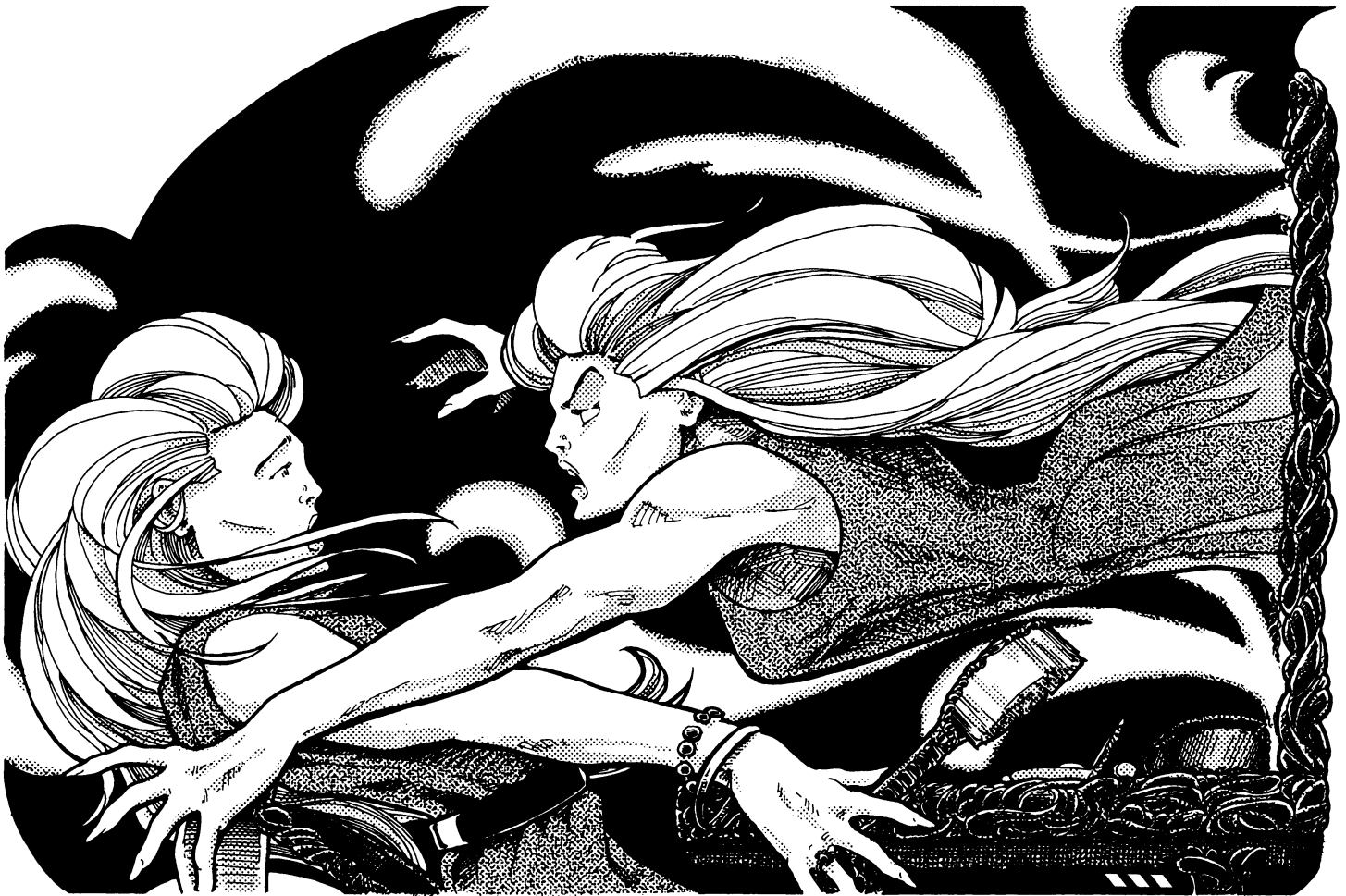

without conflict. Doppelgangers of a good alignment who are accidentally swept to Earth or sent there by the Nightlords, can resist their murderous urges and lust to survive and not kill their counterpart. In such instances, the creature shrivels up, dies and vanishes 48 hours after his arrival to Earth.

As **villains**, the Doppelganger character makes great spies and assassins. Humans who know about them must constantly worry that someone among them may actually be a visiting enemy Doppelganger, or worse, has killed a friend or ally and has taken his/her place in their organization or in the world. The vast number of these creatures can only add to the level of suspense, drama, suspicion and paranoia of the game setting — begging the question, “Are we all whom we seem to be?”

One last fact of note: Nightbane never have Doppelgangers, which seems to indicate that Nightbane are indeed a completely separate species.

Creating Doppelganger Characters

There are two ways to create a Doppelganger: “Random” Doppelgangers should be rolled up as per the table below. Skills can be determined randomly or as the Game Master sees fit.

When creating the Doppelganger of a specific person, use the same attributes as the person in question (or roll up the same as a typical human). Regarding skills, roll 1D6 for each: A result of 1 or 2 means the skill is not known by the Doppelganger, a 5-6 means it is known at the same skill level, and a 3-4 means it is known, but at -10% of the human’s level.

Player character Doppelgangers are rolled up normally. A character who opposes the Nightlords will be considered a traitor or a fool. Thus, if captured by Dark minions, the character will be tortured before he or she is finally slain. It might even be possible for one player to run a normal human and for another to play his Doppelganger, but that means the Doppelganger must return to the Nightlands every other day or trade places — or one must kill the other (or let himself die), so this option is only recommended to mature role-players.

Alignment: Any; when creating a specific individual’s Doppelganger, roll percentiles (or choose one):

01-20%: Same alignment.

21-50%: One “category” down the scale (for example, principled becomes scrupulous, or aberrant becomes miscreant).

51-70%: One “category” up the scale (for example, anarchist would be changed to unprincipled; principled characters stay the same).

71-80%: Total opposite: Good and selfish characters become evil (principled and scrupulous are changed to diabolic, anarchist is changed to aberrant, and unprincipled is changed to miscreant) and vice versa).

81-00: Random change; roll 1D6 to determine what the Doppelganger’s alignment is, counting right after the alignment of the double (for example, if the character was aberrant, a roll of 1 would mean a change to diabolic, 2 would go back to the “top” and be principled, 3 would be scrupulous, and so on).

Attributes (same as humans): I.Q. 3D6, M.E. 3D6, M.A. 3D6, P.S. 3D6, P.P. 3D6, P.E. 3D6, P.B. 3D6, Spd. 3D6. **Supernatu-**

ral attributes, if a copy of a specific character already known to exist, the stats will be identical.

Size and Weight: Varies, but within human range. Identical to already existing characters.

S.D.C./Hit Points: Use normal rules, but add 20 to the total S.D.C.; Doppelgangers are slightly more resilient than normal humans.

Horror Factor: 9 when their true nature is revealed.

P.P.E.: 1D4; Doppelgangers have less average P.P.E. than most humans. The exceptions are Doppelgangers of human magicians who have two-thirds the P.P.E. of their counterparts (i.e., if a human sorcerer had 120 P.P.E., his Doppelganger would have 80 P.P.E.).

Natural Abilities: Doppelgangers do not need food or water to survive, although they enjoy the experience of tasting food; instead, they live by absorbing ambient P.P.E. They heal damage faster than humans: 1 Hit Point/S.D.C. plus P.E. bonuses (if any) of damage are healed every hour! Also, Doppelgangers are immune to the vampire's slow kill bite (see the **Vampire Threat Section**) and cannot be turned into vampires; although they can be killed by them.

Combat: Same as humans.

Damage: Use the *Supernatural Strength Table* to determine hand to hand damage.

Bonuses: Awakened Doppelgangers are at +2 to save vs horror factor. All other bonuses are the same as for normal humans.

Magic Powers: Doppelgangers of human magicians can use magic; the rest are mundane/have no magic abilities.

Psionic Powers: Before they awaken, Doppelgangers have no psionic powers. After their awakening, 40% of all Doppelgangers gain minor psionic abilities. Select two powers from one of the three categories (physical, healing or sensitive). Doppelgangers of psychic characters gain all the humans' powers and two-thirds of their I.S.P.

I.S.P.: M.E. plus 2D6, or two-thirds of the human counterpart's I.S.P.

Average Life Span: Average 200 years after appearing in the Nightlands (usually appear fully grown). Most Doppelgangers are killed before they reach middle-age, but they age very slowly, and are fully active until the last few years of their life, at which point their body starts breaking down.

Experience Level: Varies, same as humans. If their counterpart is killed, Doppelgangers start at the same level as their mirror image and can advance in level normally. Awakened Doppelgangers can advance in level beyond their double's current experience level if they are more active.

Vulnerabilities/Penalties: Magic artifacts and magic weapons inflict double damage to Doppelgangers, but not magic spells.

R.C.C. Skills: Same as normal humans. When creating a player character Doppelganger, determine the O.C.C. of their counterpart to see what skills are available.

Alliances and Allies: Doppelgangers who serve the Nightlords work under the supervision of Hounds, Hound Masters, Night Princes, Hollow Men and human cultists. Those who fight their former overlords often work alongside Nightbane, vampires, humans and even Guardians.

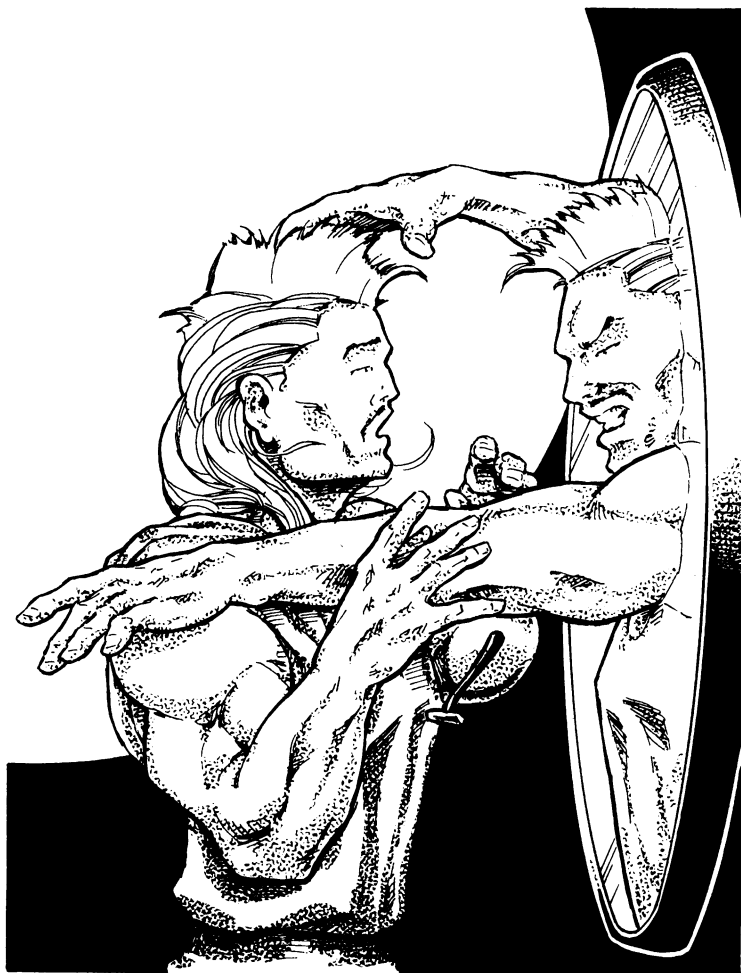

The Hounds

"All right, we are here." Gibson gestured at the four surly-looking Nightbane standing behind him in the vacant lot. They were his gang, and they had been terrorizing the neighborhood. Burger-face wanted them to join the Resistance, and to stop attacking innocent people. "Start talking."

"You and your gang are attracting a lot of attention," Burger-face started, working hard at enunciating each word. It was hard to make a good speech when your mouth is eternally barbecued, but his Facade would not impress these bruisers. "You may not believe in the Nightlords, but they'll find you and kill you."

"With what? Guns? We laugh at guns. We..." Gibson froze in mid-sentence, looking past Burger-face. "Oh, crap."

Burger-face turned. The previously empty street were now filled by a solid rank of metal men. Twenty skull faces gleamed evilly in the moonlight, and twenty spears were raised in readiness.

"Hounds," Burger-face groaned. Somebody had set all of them up. If they were lucky, one or two of the six Nightbane might escape with their lives. "Guess my warning comes too late for you."

The twenty Hounds charged forward, moving as one. Only Burger-face and one "tough" would escape with their lives.

The humanoid Hounds are the shock troops of the Nightlords, monsters through and through. They are believed to be magical constructs, similar to the golems of legend. Unlike golems, however, Hounds do feel emotions and have lusts and desires. Regrettably, those desires are all related to pain and fear. Hounds live for the hunt and slaughter. They are the ultimate warriors and trackers, relentlessly following their prey and then playing with it for a short while before finally destroying it without mercy.

It is unknown how many Hounds exist in the Nightlands, but even the lowliest Nightlord has a hundred or more of these monsters at his beck and call, the most powerful ones have entire armies. Before the invasion of Earth, the Hounds marched across the Waste and fought each other to settle the rivalries between their masters. An occasional sorcerer or Nightlord cultist would sometimes summon a Hound to serve him as a bodyguard or assassin, with the blessing of his true Nightlord master, but less than a handful could be found on Earth at any given time. Since Dark Day, however, thousands of Hounds now walk the streets of this world.

Hounds appear to be clad in black metal armor, fashioned to look like a skeletal figure. In reality, the "armor" is part of their body and cannot be removed. There is some variation in the looks and size of the Hounds, but most of them look as if they were cast from the same hellish mold. They wield bladed sticks and spears as their primary weapons (the Nightbane illustrated on the cover has a captured Hound weapon). These blades are supernaturally sharp and strong, able to pierce, cut and slash open *any* surface and material. On at least one occasion, troops of Hounds have swarmed over Earth tanks, oblivious to their own casualties, and cut the tanks open like sardine cans, massacring the helpless pilots afterwards!

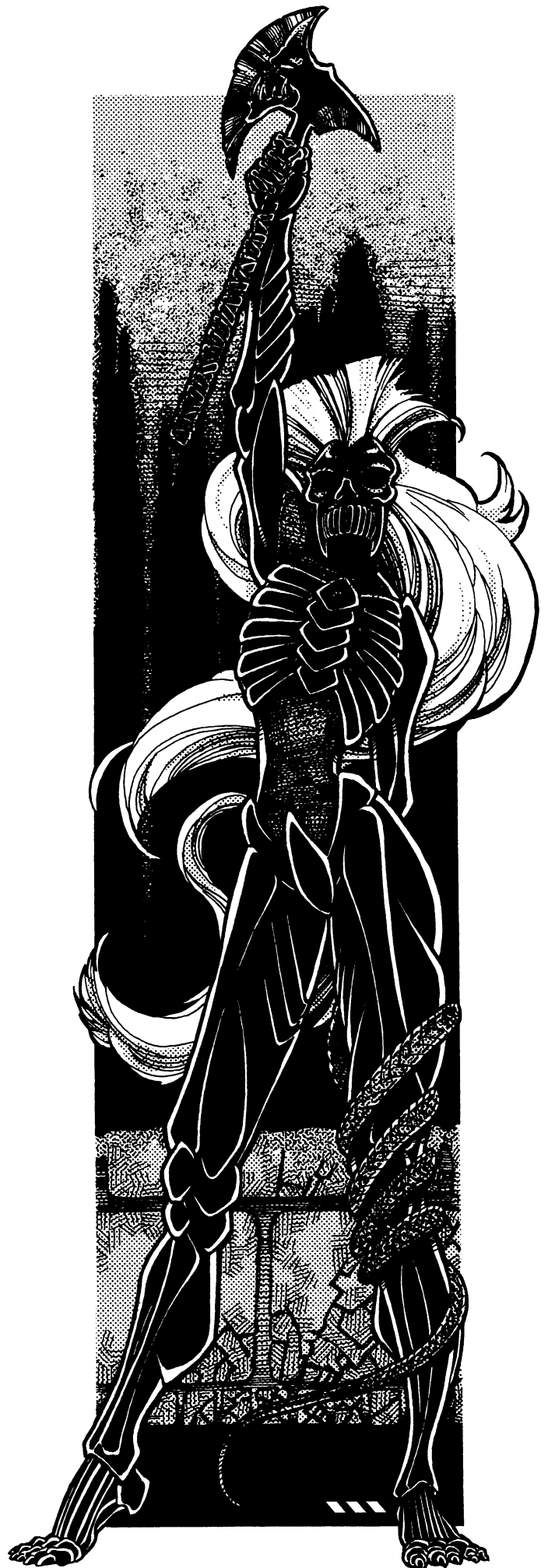

Hounds are the bane of Nightbane and other supernatural creatures. They have a supernatural sense of “smell” they can use to track down their victims. Nightbane in Morphus form have a powerful supernatural “signature” which the Hounds can follow in a manner similar to the way Nightbane can sense the presence of others of their kind. Although the power doesn’t have a long range, it allows the Hounds to follow the tracks of a supernatural being; the creatures are very hard to throw off once they have acquired a target. **Note:** Hounds are evil, supernatural predators who cannot be player characters.

Alignment: Diabolic (always).

Attributes: I.Q. 2D4, M.E. 3D4, M.A. 3D4, P.S. 3D6+14, P.P. 3D6+6, P.E. 4D6+4, P.B. 1D6, Spd. 1D4×10. Supernatural Strength and Endurance.

Size: 7 feet tall (2.1 m). **Weight:** 350 lbs (159 kg)

A.R.: 13 against normal weapons (zero against magical and supernatural attacks).

S.D.C.: 200, **Hit Points:** P.E. ×3

Horror Factor: 13

P.P.E.: 1D6×10

Natural Abilities: Immune to all illusions and powers of concealment (can see through the Shroud Talent, normal invisibility spells, and any magical or psionic powers of disguise or camouflage); nightvision 2000 foot (610 m) range, expert tracker (track animals and humans at 80% proficiency).

Self-healing: Will heal all damage taken if allowed to stand still for an entire hour (enters a regenerative trance). **Supernatural Tracking:** Can smell supernatural creatures and track them (range: 60 feet/18.3 m, base skill: 50% plus 5% per level).

Partial Invulnerability: Takes half damage from all non-magical weapons and attacks.

Combat: Equivalent to hand to hand: assassin, with one additional strike or attack per melee round, starting at level one.

Damage: Supernatural Strength (see the *Supernatural Strength Table*). Typically use bladed staffs for combat (3D6 plus P.S. damage) which can cut through all known materials, including steel, like butter.

Bonuses: +1 on initiative, +1 to strike, parry and dodge, +3 save vs magic and psionics, +4 to save vs horror factor, +4 on all perception rolls, immune to illusions and concealment magic and psionics.

Magic Powers: None
Psionic Powers: None

Average Life Span: Unknown; may live for centuries, but are often killed in combat or war.

Experience Level: 1D4+1. Almost no Hound progresses beyond the 5th level of experience.

Vulnerabilities/Penalties: Takes double damage from magic artifacts, weapons, Talents and powers/spells.

R.C.C. Skills: Minimal skills. Natural tracking 80%, can understand (but not speak) all languages magically. Swimming and climbing 98%; W.P. polearm and sword.

Alliances and Allies: The Hounds serve the Nightlords and their avatars. Sometimes they are placed under the command of an important Doppelganger or Hollow Man. They typically work side by side with the Hunters (see below).

Weapons: Darkblade Spears (3D6 plus base P.S. damage, cuts through anything); rarely issued other weapons.

Body Armor: None; their metallic exoskeleton is all the armor they need.

Hound Masters

These troop leaders are Hounds graced with higher intelligence and initiative as a “reward” for their services. They have exoskeletal armor like their lesser brethren, but their skull-helmets are often decorated with twisting horns, and they wear black capes as a badge of office. They are also gifted with minor psionic abilities and the powers of illusion that enable them to mask their nature from normal humans. Unlike typical Hounds, the Masters are capable of speech, although they usually limit themselves to giving orders, cursing or intimidating victims.

Hound Masters are most commonly found leading large bodies of Hounds (20 or more), or at the head of a smaller team assigned to an “undercover” mission, such as finding a group of Nightbane in an Earth city. In the second case, only 3-5 Hounds (the maximum group a Hound Master can disguise with his illusionary powers) will back up the Master. Sometimes, these creatures will be sent on solo missions, although such activities are typically left to the Night Princes, Nightlord Avatar or other more powerful minions. Only the lesser Nightlords will place so much trust in a “mere” Hound Master.

Sometimes, a Hound Master will decide to betray his overlords, usually by going over to the service of another Nightlord, less often by going renegade. These outlaws usually become criminals and brigands, hunting humans for sport, occasionally falling under the control of a powerful sorcerer. It is rumored that a few renegade Hound Masters can be found working with (or controlling) some street gangs on Earth, often coming into conflict with the Warlords.

Note: Hound Masters are diabolic predators, not recommended as player characters. If a player character, he will be evil or, at best, a ruthless anarchist.

Alignment: Diabolic or miscreant (never aberrant or good).

Size: 7 feet tall (2.1 m), plus horns. **Weight:** 350 lbs. (159 kg)

A.R.: 14 against normal weapons (zero against magical and supernatural attacks).

S.D.C.: 250, **Hit Points:** P.E. ×3

Horror Factor: 14

P.P.E.: 2D4×10

Attributes: I.Q. 2D4+6, M.E. 3D4+3, M.A. 3D4+3, P.S. 2D6+20, P.P. 2D6+12, P.E. 3D6+10, P.B. 1D6, Spd. 1D6×10. Supernatural Strength and Endurance

Natural Abilities: Immune to all illusions and powers of concealment (can see through the Shroud talent, normal invisibility spells, and any magical or psionic powers of disguise or camouflage); night vision 2000 foot (610 m) range, expert tracker (track animals and humans 80%).

Self-healing: Will heal all damage taken if allowed to stand still for an entire hour (enters a regenerative trance). **Supernatural Tracking:** Can smell supernatural creatures and track them (range: 80 feet/24.4 m), base skill: 50% plus 5% per level).

Partial Invulnerability: Takes half damage from all non-magical weapons and attacks.

Illusion Powers: Hound Masters can create illusionary *shells* around themselves and up to five others. Typically, they will use this power to pass as normal humans. This is a psionic ability costing 4 I.S.P. to disguise themselves, and 8 I.S.P. to disguise others. Duration of the Illusion is a period of 10 min-

utes per level of experience for oneself only, or 5 minutes per level of experience to disguise two to five people.

Combat: Equivalent to hand to hand: assassin, with one additional attack per melee round, starting at level one.

Damage: Supernatural Strength (see the *Supernatural Strength Table*). Typically use bladed staffs for combat (3D6 plus P.S. damage).

Bonuses: +2 on initiative, +1 to strike, parry and dodge, +3 save vs magic and psionics, +6 to save vs horror factor, +4 on all perception rolls, immune to illusions and concealment created by magic and psionics.

Magic Powers: None

Psionic Powers: Minor Psychic abilities include the powers of mind block and empathy. Also, see their Illusion Powers, above.

I.S.P.: M.E plus 1D6×10, plus 2D6 per level of experience.

Average Life Span: Unknown; may live for centuries, but are often killed in combat or war.

Experience Level: 2D4+1.

Vulnerabilities/Penalties: Takes double damage from artifacts, weapons and powers/spells.

R.C.C. Skills: Minimal skills. Natural tracking 85%, can speak all languages magically. Swimming and climbing 98%; W.P. polearm and battle axe.

Alliances and Allies: Hound Masters serve the Nightlords and their avatars. Sometimes they are placed under the command of an important Doppelganger or Hollow Man or sent on a lone mission leading Hounds or lowly Doppelgangers. They typically work side by side with the Hunters.

Weapons: Darkblade Spears (3D6 plus base P.S. damage). Rarely issued other weapons.

Body Armor: None; their metallic exoskeleton is all the armor they need.

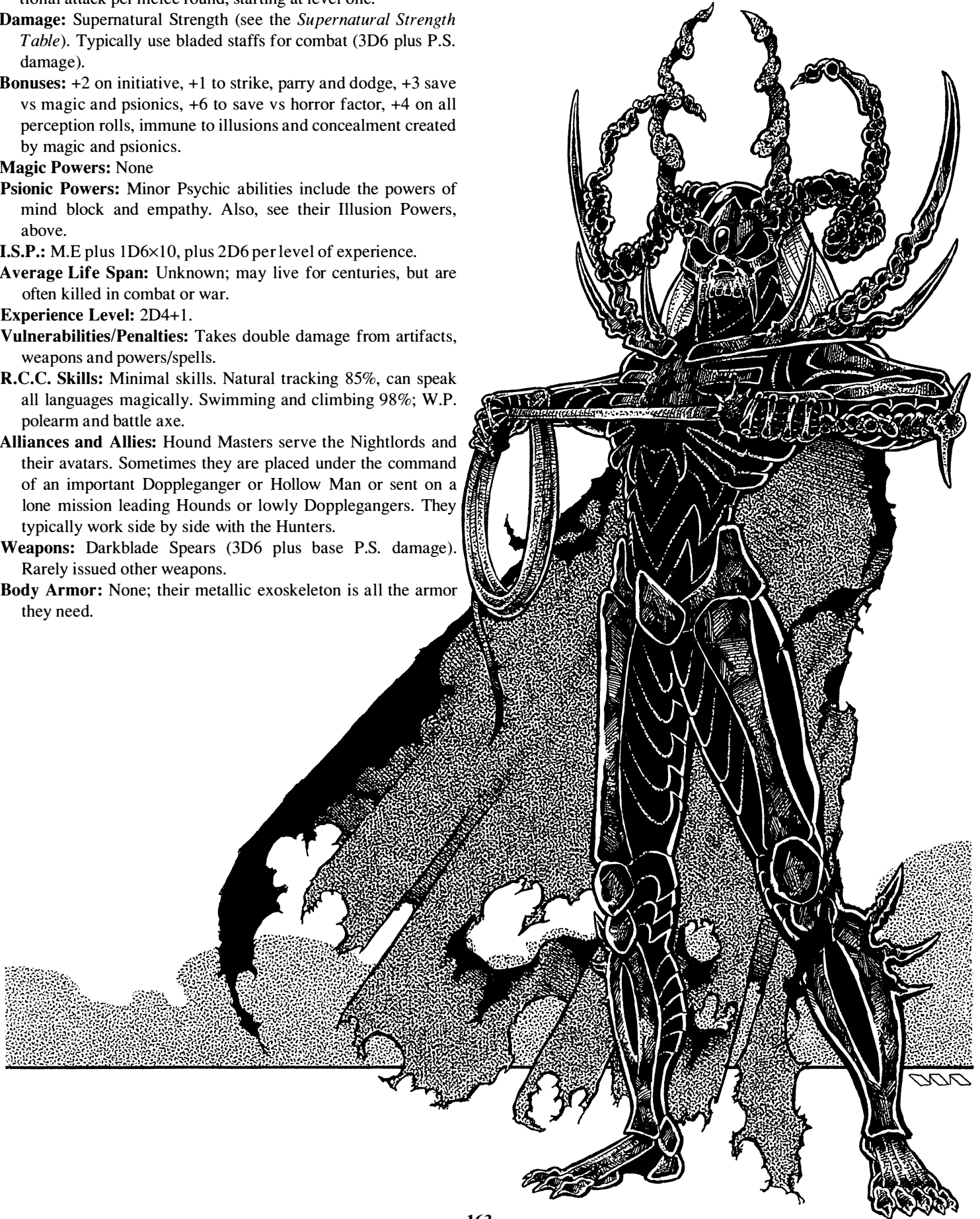

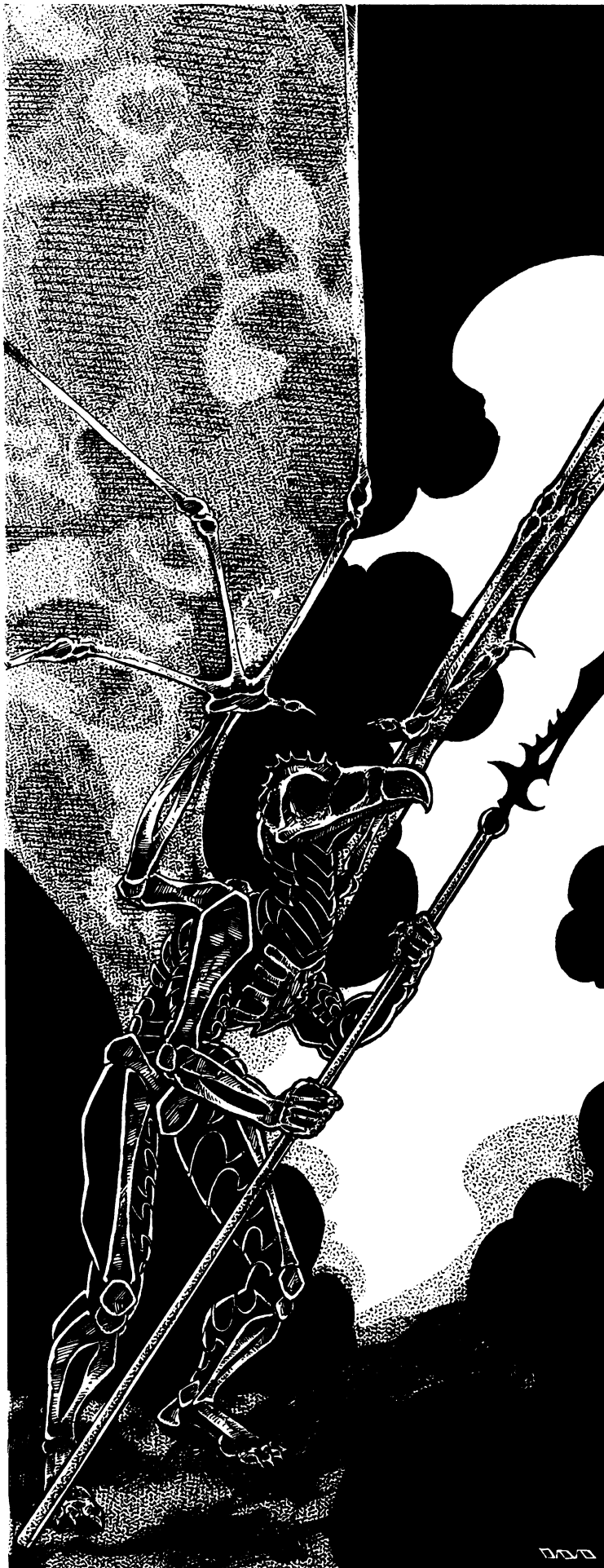

The Hunters

Private First Class Jose Ramirez gripped his rifle so hard his hands started to go numb. He and the rest of the platoon were AWOL, but fear of being found by scowling MP's wasn't what made his hands tremble as he desperately looked into the darkened forest. He and the trooper next to him were marching quickly through the forest, barely able to see the guys ahead of them.

They had heard the frantic radio call, the shouts that people were being murdered throughout the base. Then a short period of silence, followed by the orders that all the troops on maneuvers should return to the base. The orders had been so strangely phrased that the Lieutenant deliberately disobeyed them. He then led the platoon on a roundabout route to the base to see what the hell was going on.

They saw plenty when they got there. Dead soldiers — and pieces of dead soldiers — littered the ground. Some bad ju-ju had gone down in there. Now the Lieutenant was trying to move his command as far away from the base as possible. A small town was a few miles away. If they didn't get lost, they would be out of the woods — figuratively and literally.

A loud clang and a shortened scream startled him. Ramirez spun around. One of the soldiers behind him was down. His helmet rolled towards him, and he realized with a sickening jolt that the soldier's head was still attached to it. Next to him. O'Grady screamed and fired a long burst up in the air. The flashes all but blinded him. When his vision cleared, Ramirez saw two dark figures sweeping down on him. He was bringing his rifle to bear when he felt a brutal impact on his head. Pain and light exploded inside him. And then he felt nothing at all.

Hunters are the flying companions of Hounds. They too are covered in a black skeletal armor, however their head/helmets are shaped like a vulture's, with a long, curved beak. Two bat-like wings protrude from their backs, allowing them to fly. They act as the aerial hunters, scouts and messengers of the Nightlords. Typically, there is one Hunter for every ten Hounds in a Nightlord's army. They share the Hounds' love for hunting and murdering innocent victims.

In the Nightlands, Hunter patrols of 4-16 (4D4) warriors fly over the roads linking the city-states and also around the area of their master's domain, searching for intruders, enemy armies and monsters from the Waste. They were employed in great numbers during the early stages of the invasion of Earth, especially in assassination missions. The Hunters are exceedingly adept at attacking victims living in high-rise buildings. They occasionally patrol the night skies of Earth cities, giving rise to a whole slew of "monster sightings" which are ignored by the Nightlord-controlled authorities.

Alignment: Diabolic

Attributes: I.Q. 2D6, M.E. 3D6, M.A. 3D6, P.S. 3D6+14, P.P. 2D6+10, P.E. 3D6+6, P.B. 1D6, Spd. 1D4×10 on the ground, 1D4×10+40 flying. Supernatural Strength and Endurance.

Size: 7 feet tall (2.1 m). **Weight:** 400 lbs (181 kg)

A.R.: 13 against normal weapons (zero against magical and supernatural attacks).

S.D.C.: 180, **Hit Points:** P.E. ×3

Horror Factor: 15, **P.P.E.:** 1D6×10

Natural Abilities: Immune to all illusions and powers of concealment (can see through the Shroud Talent, invisibility spells, and any magical or psionic powers of disguise, illusion, or camouflage); nightvision 2000 foot (610 m) range, expert tracker (track animals and humans 80%).

Self-healing: Will heal all damage taken if allowed to stand still for an entire hour (enters a regenerative trance). **Supernatural Tracking:** Can smell supernatural creatures and track them (range: 100 feet/30.5 m), base skill 40% plus 5% per level).

Partial Invulnerability: Takes half damage from all non-magical weapons and attacks.

Combat: Equivalent to hand to hand: assassin, with one additional attack at level one.

Damage: Supernatural Strength (see the *Supernatural Strength Table*). Typically uses wickedly curved short swords in combat (2D6 plus P.S. damage). Beak attack inflicts 3D6 S.D.C.

Bonuses: +1 on initiative when on the ground, but +3 to initiative in the air, +1 to strike, parry and dodge, +2 to dodge while flying, +3 save vs magic and psionics, +5 to save vs horror factor, +4 on all perception rolls, immune to illusions and concealment magic and psionics.

Psionic Powers: None

Magic Powers: None

Average Life Span: Unknown; may live for centuries, but are often killed in combat or war.

Experience Level: 1D4+2. Almost no Hunter progresses beyond the 6th level of experience.

Vulnerabilities/Penalties: Takes double damage from Artifact weapons and powers.

R.C.C. Skills: Minimal skills. Tracking (sight) 70%, can understand (but not speak) all languages magically. Swimming and climbing 98%; W.P. sword or polearm.

Alliances and Allies: Hunters tend to work alongside Hounds and other minions of the Nightlords.

Weapons: Darkblade Scimitars (2D6 plus base P.S. damage). Rarely issued other weapons, but a few wield Darkblade Spears (3D6 plus base P.S. damage).

Body Armor: None; their metallic exoskeleton is all the armor they need.

Ashmedai

The Crawling Horrors

Many are the fearsome stories about the Ashmedai, the monstrous servants of the Nightlords. They are said to live in some hellish dimension until the Nightlords summon them. Some legends claim the Ashmedai are actually Nightbane, and that their horrible worm-like forms are the Nightbanes' True Shape. Some tales make them the guardians of the mythical Formless Ones, a warrior race who switched allegiance when the Ba'al conquered the Nightlands.

As an independent race, they have more initiative and self-reliance and are often used by the Nightlords on special missions where the servile Hounds and Hunters won't do. A few Ashmedai have left the service of the Ba'al, because the worms' malevolent natures make it impossible to form a lasting alliance with an other beings. They either roam the Waste or have made a home on Earth, where they hunt humans for pleasure. It is rumored that a few nests of as many as six crawling horrors have been built in some Earth cities, where the renegades hunt at will. These renegade Ashmedai are persecuted by the Nightlords and their minions for their treachery and because they jeopardize the scheme to keep supernatural forces hidden from humans (at least until the Ba'al dominate the planet).

The true form of the Ashmedai is a worm-like, fleshy giant, with no apparent eyes and four long tentacles protruding from the sides of his serpentine trunk. The head is dominated by a gaping maw filled with sharp teeth and four main fangs in each corner. Unfortunately, the creatures are master shape-shifters, able to assume any form they desire. The monsters can hide themselves in a human or animal shape, undetected and unsuspected. Only some magical spells, psychic powers and Nightbane Talents can unmask the creatures.

In addition to their shape-shifting abilities, the Ashmedai have limited psionic powers that enable them to act as spies and manipulators. They do not have any Nightbane Talents, so suspicions that they are members of that race are unfounded, although such wild speculation persists. Some Ashmedai do pass themselves off as Nightbane, however, using special magic artifacts created by the Nightlords to hide their true nature or imitate Nightbane Talents. Luckily, only a few such artifacts exist.

A race of supernatural predators, the Ashmedai live not on flesh but on the *life force* of their victims (also known as Potential Psychic Energy/P.P.E.). While the monsters often bite and tear the victim's flesh, they will rarely eat much, if any, of it. The only goal of their brutality is to "flavor" the life energies with terror and agony (also, the victims' P.P.E. reserves are doubled at the moment of death). When hunting on their own, the Ashmedai will stalk and toy with the victim.

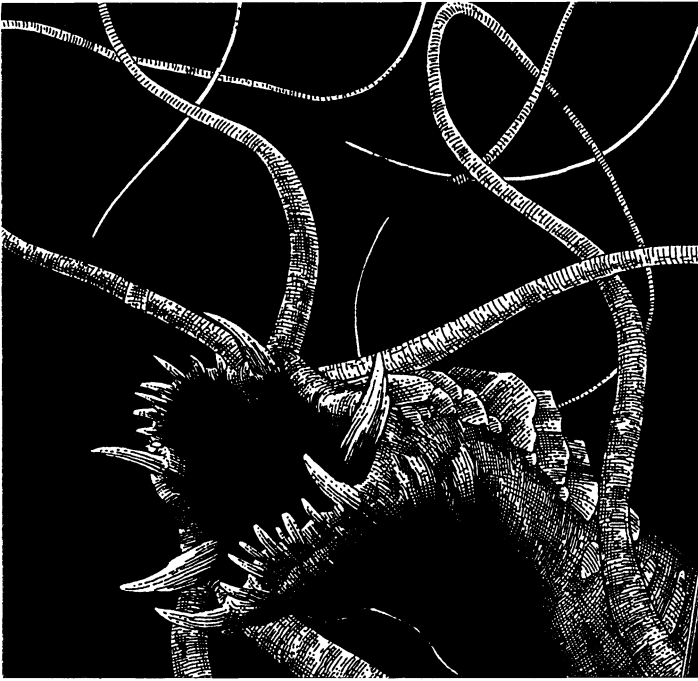

Their shape-shifting powers make them ideal agents for the Nightlords. Although the Ashmedai are not adept enough at imitating individuals (base 25% chance of successfully imitating a particular human), they are great for espionage and assassination missions. Some Ashmedai have joined the ranks of the NSB, where they masquerade as Federal agents. Others act as bodyguards, enforcers and even political leaders.

Alignment: Typically Diabolic or Miscreant, with a few Aberrant types.

Attributes: I.Q. 2D6+12, M.E. 2D6+10, M.A. 2D6+10, P.S. 3D6+14, P.P. 2D6+12, P.E. 3D6+12, P.B. 1D4 (or varies with shape), Spd. 1D4×10. Attributes are considered to be Supernatural.

Size (true form): 8 to 12 feet (2.4 to 3.6 m) from top of the head to the tip of the tails. The tentacles have a reach of 6 feet (1.8 m).

Weight (true form): 300 to 800 lbs. (136 to 362 kg)

S.D.C.: 3D6×10+150 in base form. While wearing a human-sized shape, S.D.C. is reduced by 100. A small-sized Ashmedai (the size of a medium dog, for instance) has 120 less S.D.C., and a tiny form (a bird or rat) has 180 less S.D.C. (minimum 10).

Hit Points: 2D4×10+20; hit points remain constant in all forms.

Horror Factor: 14 when its true form is revealed.

P.P.E.: 2D4

Natural Abilities: Supernatural Vision: Although the Ashmedai have no eyes in their true form, they can see through supernatural senses. They can see the invisible and in total darkness (up to 2000 feet/610 m). This works in any and all forms it may select. Bio-regenerate 1D6×10 S.D.C./Hit Points every minute (4 melee rounds).

Shape shifting: The Ashmedai can shape shift at will into the form of any living creature, from a mouse to an elephant. It is believed that mouse-size is the limit; they cannot transform themselves into insects. While wearing an animal form, the Ashmedai can use all the abilities of that form (such as flight, running, swimming, etc). The Ashmedai can even create monstrous shapes for themselves, with claws, sharp teeth, etc.

(refer to the *Nightbane Creation Tables* for some available appearances and abilities). Bio-mechanicals and other inorganic modifications are beyond their ability, however. Changing into small creatures will temporarily reduce the Ashmedai's S.D.C., but not its hit points. Changing from one form to the next counts as one melee attack/action.

Combat: Supernatural, and it may have some Weapon Proficiencies.

Damage: In true form, tentacle adds 1D6+6 to supernatural P.S. damage (see the **Supernatural Strength Table**). Use the supernatural P.S. table to determine damage in human form, or in some animal forms.

Bonuses: +3 to strike, parry and dodge, +5 to roll with fall or impact, +5 to pull punch, +3 save vs magic, +5 to save vs psionics, +8 to save vs horror factor. Not counting attribute bonuses.

Magic Powers: None

Psionic Powers: Knows the following psychic abilities: Alter aura, empathy, mind block, see aura, and telepathy.

I.S.P.: 2D4×10+20

Average Life Span: Believed to average 300 years, but some have lived much longer.

Experience Level: 1D6+1 (equivalent to a Psychic).

Vulnerabilities/Penalties: None (no special invulnerabilities, either).

R.C.C. Skills: Can learn 8 skills from any category (but cannot ignore prerequisites), with a +10% bonus plus I.Q. bonus, and an additional 12 secondary skills. Combat bonuses from physical skills apply only to a human or humanoid shape. Cannot learn any hand to hand combat skills (already has instinctive skills).

Alliances and Allies: As servants of the Nightlords, the Ashmedai often work side by side with Hounds, Hunters, and Hollow Men. The occasional renegade will form a temporary partnership with a vampire, murderous human, other supernatural menaces and similar evil characters.

Weapons and Equipment: NSB agents are assigned Beretta 95 machine pistols (damage 2D6, 20-round magazine, can fire bursts and full automatic), or heavier weapons (M-16 rifles typically) if the situation demands it, as well as hazardous duty battle armor (A.R. 16, 260 S.D.C.).

A few elite agents of the Nightlords are given ancient artifacts known as **Nightbanes' Skins**. These black capes are silky and light, and when worn are absorbed into the skin until the wearer chooses to remove them. While the Skin is worn, the wearer will "read" as Nightbane by the senses of other Nightbane, magic spells of detection, and psionic powers. Less than 20 of these Artifacts are known to exist, and they are all in the possession of High King Moloch or his agents. Using this artifact will drain the user of all his P.P.E. until it is removed (P.P.E. recovers as normal). A human (or, for that matter, a vampire) wearing this cape would also register as a Nightbane.

Namtar — the Hollow Men

The Namtar are a race of tiny pseudo-insects, also originating in another dimension. The repulsive creatures appear to be beetle-like creatures with a slimy carapace and eight legs. Some Namtar can be found scurrying around the great palaces of the Nightlords, but more often, they ride inside one of their constructs, the *Hollow Men*.

Like some insects, the Namtar can build things out of blood, mud, and their own noxious secretions. Unlike normal insects, the Namtar use magic to give their creations a semblance of life. They build human-sized mannequins around themselves, like larvae surrounded by a cocoon. This cocoon can walk, run, fight, and look like a human. Although called Hollow “Men,” the Namtar can build male and female constructs. Although humanoid shapes appear to be their favorites, they can make Hollow Men resemble demonic creatures and humanoid monsters, but the Nightlords have ordered their servants to make human-looking constructs to act as their agents on Earth.

Thousands of Namtar-bearing Hollow Men now walk the streets. A large number of Namtar constructs are members of the NSB, the National Security Bureau. They dress in conservative black suits and favor dark glasses to conceal their impassive eyes. Their behavior and clothing are so similar that they are commonly known as the “Men In Black,” using the old term for the mythical government agents that allegedly intimidated UFO witnesses. This new crop of Men In Black (aka the MIB) concentrate on “terrorist activities,” which includes the investigations and activities of journalists, clergy, researchers, dissidents, Nightbane, sorcerers, psychics and other nosey people looking into the activities of the Nightlord-controlled governments, Nightbane, magic, and the paranormal.

Although these creatures tend to be less sadistic than other Nightlord minions, the Hollow Men have no mercy or sympathy for the plight of human beings. After all, beneath their human construct lies a demonic insect, totally alien to human experiences. Hollow Men will typically take the most efficient and direct path to accomplish their goals — if threats will do the job, fine, but if torture, murder and random violence are necessary, the Hollow Men will do it without raising an eyebrow.

Alignment: Diabolic or Miscreant.

Attributes (Namtar): I.Q. 3D6+6, M.E. 3D6, M.A. 3D6, P.S. 1D4, P.P. 3D6, P.E. 2D6, P.B. 1D6, Spd. 2D4

Attributes (Hollow People): P.S. 3D6+2, P.P. 3D6, P.E. 3D6, P.B. 3D4, Spd. 3D6+6. Strength and Endurance are considered to be Supernatural.

Size (Namtar): 1D6+6 inches (5 to 20 cm). **Hollow Man:** Varies, typically 6 feet (1.8 m)

Weight (Namtar): 1D4 lbs (0.45 to 1.8 kg). **Hollow Man:** Varies, typically 150-250 lbs. (68 to 113 kg)

S.D.C. (Namtar): 10; **Hollow Man:** 2D4×10+80

Hit Points (Namtar): P.E. plus 10. **Hollow Man:** None (magical construct, only S.D.C. applies).

Armor Rating: 12; **Hollow Man:** 8; these constructs look human but their pale white or yellowish white skin is tougher than a human’s and has a tough fabric texture similar to a burlap bag. Their eyes are dark and blank (or “dead” looking as many have described them).

Horror Factor: 9 as a beetle-thing; 11 as the MIB, and 15 when the Namtar climbs out of a Hollow Man — usually by popping through the neck or tearing off the head from the inside out.

P.P.E.: 4D6+10

Natural Abilities: The Namtar have perfect color vision, nightvision (400 feet/122 m), a good sense of smell, are impervious to disease, impervious to cold, magically understand and speak all languages (89%); prowl 40% (only in insect form), swim 50% (in either form), and like real insects, can climb up walls and on ceilings without difficulty. The Constructs are immune to all illusion and invisibility powers and spells (including the Shroud, shadow meld and similar powers). Also, the construct needs to be shot or cut to pieces before it stops functions: the creature can continue fighting until reduced to -25 points, at which point it will shatter or break, and the Namtar will leap away. The Namtar can heal any damage the construct took, as long as it wasn’t destroyed, at the rate of 10 S.D.C. every hour.

Building Hollow Man: The Namtar mix together mud, human blood and their secretions to create a life-like dummy. Fresh human blood *must* be added to the mixture to produce a human-looking Hollow Man, otherwise the construct will look as if it were made of plaster of paris or tired rags. This process takes 4D6 hours. Hollow Men can speak with a normal voice, walk, run and use weapons the same as a normal human (see attributes and skills). The Namtar aren’t very good at manipulating facial muscles or manipulating the construct to react to emotions, so their creations tend to have a very cold and impassive attitude, even when bullied and



threatened (the Namtar may be scared, but the Hollow Man cannot show it!). The Namtar see through the black eyes of their creation. They know that the false eyes look eerie to other humans, so they usually wear sunglasses, mirrored shades or goggles, even at night.

Combat: Equivalent to Hand to Hand: Expert (for the Hollow Man, not the Namtar).

Damage: The Hollow Men have supernatural strength (see the **Supernatural Strength Table**).

Bonuses (Namtar): +1 on initiative, +2 on all perception rolls, +4 to dodge, and +6 to save vs horror factor. Add one attack per melee when piloting a Hollow Man construct.

Magic Powers: They have the magic-like ability to create Hollow Men and understand and speak all languages, but nothing more.

Psionic Powers: None

Average Life Span: 500 years.

Experience Level: Average 1D4+3.

Vulnerabilities/Penalties: Both the construct and the Namtar themselves take double damage from magical attacks and physical attacks from other supernatural creatures.

R.C.C. Skills: Select 10 skills from any category and a +10% bonus, and add an additional 10 secondary skills. Typically know a number of police and military-oriented skills and 2 or 3 weapon proficiencies.

Alliances and Allies: Nightlords and their minions. Occasionally associate with other powerful and evil supernatural beings.

Weapons and Equipment: Hollow Men who act as NSB agents get the full agent kit, including walkie-talkies, handguns and sub-machineguns. When going after dangerous “criminals,” they wear full body armor (A.R. 16, 260 S.D.C.) and carry assault rifles (typically M-16s).

The Waste Creatures

In the empty territories surrounding the cities of the Nightlands, monsters that defy description prowl and hunt the unwary traveler. They tend to avoid the roads, and travelers leaving the dark pathways risk encountering these creatures. In addition to the monsters that follow, many other demonic beasts prowl the Waste. Game Masters can create their own, or use creatures from other Palladium RPG products. **Palladium’s Book of Monsters and Animals**, a sourcebook for the **Palladium (fantasy) RPG**, is full of animals and creatures both strange and mundane, which could be brought in with no or little modification or could be a useful source of ideas and inspiration. Likewise, beings described in **Beyond the Supernatural** and **Mystic China** can be used without modification, as well as beasts from **Rifts**, **Rifts Conversion Book**, **Rifts: Wormwood**, and other books (creatures from these latter titles will require some modification).

Waste Coyote

This so-called “coyote” is a common scourge of the Waste. Despite its name, the creature bears very little resemblance to either coyotes or canines. Instead it looks like a cross between a crocodile and a bear, with a long reptilian snout, furry and heavy body, and large, heavy retractable claws at the end of each foot. The Waste Coyote runs on all fours, but can stand on its rear legs and swipe at victims with its claws. They run in small packs of 4-12 adults, led by an “alpha,” typically the largest and strongest creature in the pack. They communicate in yips and howls that sound a great deal like a coyote.

Waste Coyotes hunt to eat, but they seem to be able to survive very long periods (at least months, and possibly years) without eating. This leads some scientists to believe the creatures sustain their metabolism with ambient P.P.E. energy and only eat flesh to gain more body mass — i.e., to grow larger. Whatever their reasons, the Waste Coyotes will attack lone travelers and small parties, as well as any animals from mouse to elephant-sized. They are not scared of men or their guns, and have even been known to attack Nightbane, Hounds, and Hunters. They are very smart and cunning animals, who often set up ambushes with one member (usually the weakest) appearing somewhere to draw attention and gunfire while the rest of the pack attacks from one or two other directions. The only animal they typically leave alone is the *Lizard King* and large parties of Hounds, Hunters and Nightbane.

Alignment: Considered to be a Miscreant predator.

Attributes: I.Q. 2D4 (high animal intelligence), M.E. 2D6, M.A. 2D6, P.S. 1D6+24. P.P. 1D6+14, P.E. 1D6+20, P.B. 1D6, Spd. 1D4×10.

Size: 8-12 feet long (2.4 to 3.65 m).

Weight: 400-800 lbs. (181 to 362 kg)

S.D.C.: 2D6×10+20, **Hit Points:** P.E. ×2

Horror Factor: 11

P.P.E.: 4D6

Natural Abilities: Good trackers (track by both sight and scent, 78%).

Combat: Natural abilities. Three attacks per melee round.

Bonuses: +1 to initiative, +2 to strike, +3 to dodge, +4 to perception rolls, +4 to save vs magic and psionics. Plus attribute bonuses.

Damage: Bite does 4D6 S.D.C. Claws do supernatural P.S. damage plus 2D6 S.D.C. (see the *Supernatural Strength Table*).

Magic: None

Psionics: None

Average Life Span: 60 years

Habitat: Original habitat unknown. Current habitat: The deserts and mountains of the Nightlands. A pack of 2D6 may occasionally be brought to Earth via a dimensional Rifts, gate or anomaly.

Enemies: Hunted by Hounds and Hunters (their pelts often decorate the halls of the Nightlords), humans, and other predators. They prey on just about everything.

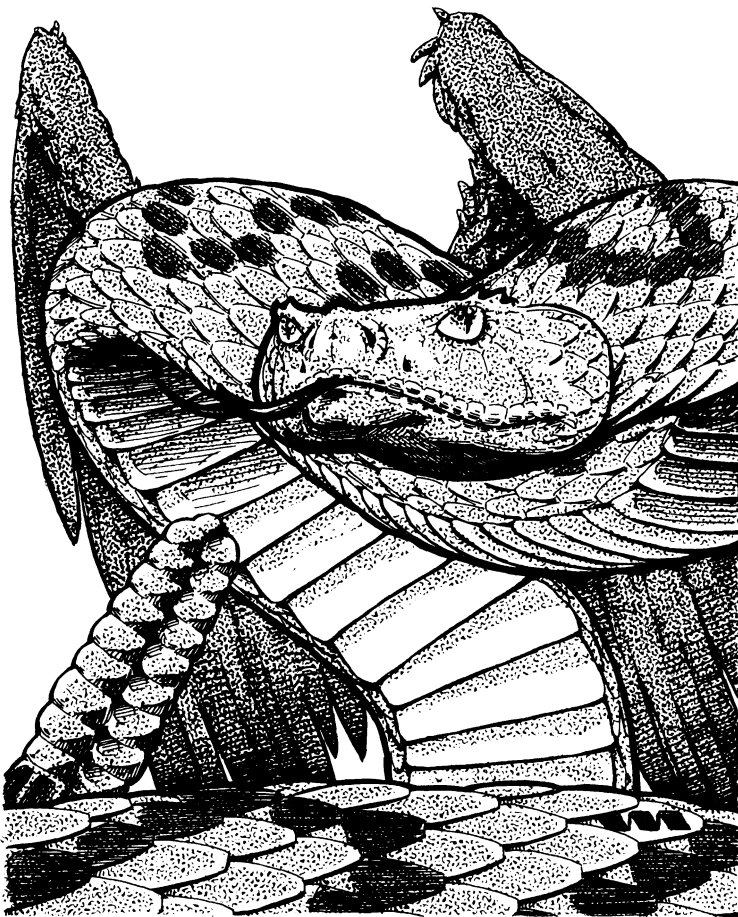

Snake Bird

This creature bears a striking resemblance to the extinct feathered serpents of Earth. Snake birds are roughly the size of a rattlesnake, with a pair of feathered wings and taloned legs near its midsection. Both the snake body and the wings are brightly colored, ranging from solid blues, greens, reds and yellows to mottled, striped and spotted patterns of all those colors plus black and white. They are very powerful fliers (unlike the true feathered serpents), able to maneuver and dive like an eagle.

Amazingly, Snake Birds are sentient and able to speak in a squawking, amusing voice. They are believed to have come from an alien dimension where most living creatures are capable of speech. Furthermore, these creatures are accomplished spell casters! They know a great deal about spell magic, many of which are unknown on Earth (**G.M.'s Note:** Snake Birds have access to any spells in the **Nightbane RPG**, **Palladium RPG**, **Rifts** and **Beyond the Supernatural**). The creatures are lone hunters and predators, hunting by themselves or (more rarely) in mated pairs. They do not need food to survive, but have strong predatory instincts, probably dating back to the time before their transformation into supernatural creatures. Some occultists have studied the Snake Birds and decided they are some sort of magical creation that combined animal parts and a human mind.

Like humans, Snake Birds can be good, evil or indifferent. Most of them distrust humans and most bipedal races, but on occasion, some have become friends and "familiars" to magicians or Nightbane. Some evil Snake Birds have become "pets" to

the Nightlords, who make them use their magic to amuse the Ba'al by torturing humans and Doppelgangers. Players looking for a challenge might even consider using a Snake Bird as a player character! This is, of course, left to the Game Master's discretion (**Note:** Snake Birds use the Mystic's experience table).

Alignment: Any.

Attributes: I.Q. 3D6+4, M.E. 3D6, M.A. 3D6, P.S. 1D6, P.P. 3D6+6, P.E. 2D6+6, P.B. 2D6+6, Spd. 1D6×10+ 50.

Size: Body: 4-5 feet (1.2 to 1.5 m) long, wingspan: 7-10 feet (2.1 to 3 m).

Weight: 15-20 pounds (6.8 to 9 kg).

Hit Points: P.E. plus 1D4 per level of experience.

S.D.C.: 5D6

Horror Factor: 8

P.P.E.: P.E.×5 plus 12 per level of experience.

Natural Abilities: Flight, sense supernatural creatures (range 100 feet/30.5 m), exceptional vision (2 miles/3.2 km), nightvision 500 feet (152 m), regenerate damage at the rate of 5 S.D.C./Hit Points at the end of each melee round. Also, see magical abilities.

Combat: Natural Abilities. Three attacks per melee at first level or two by magic. Add one attack per melee at levels four and eight.

Bonuses: +1 on initiative and all perception rolls, +5 to strike in the air, +5 to dodge in the air (+2 to strike and dodge on the ground), +6 to damage when swooping, +2 to save versus psionics, +2 to save vs magic and +3 to save vs horror factor. Does not include P.P. bonuses.

Damage: Claws do 2D6 damage, bite inflicts 1D8 plus injects a lethal poison (3D6 damage directly to hit points on the first melee round and 1D6 for 1D6 melees unless a save vs poison is made each melee; a successful roll means the victim takes half damage). This poison affects supernatural beings as well as mere mortals!

Magic: Natural spell casters who gain additional spells through mystic revelation. At first level, the Snake Bird knows six spells selected from spell levels 1-3. At each additional level of experience, it learns 2 more spells of a level equal or below the current experience level (i.e., at second level the Snake Bird can learn two spells from levels 1-2, at third level it can learn two more spells from levels 1-3, and so on). All other magic-related abilities work as per the mystic character class (but has no psychic abilities).

Psionics: None

Average Life Span: 300 years

Level of Experience: Average 1D6+1. A few Snake Birds can reach near-legendary levels of power (12th level and up).

Skills: Prowl (silent swooping attack) 62%, track by smell 50%, occult lore (+20%). Speaks Dragonese (the mythical tongue of dragons, elves and beings of faerie), and two languages of choice at +20%.

Plus select 8 secondary skills, limited by background (where did the Snake Bird learn the skills?) and common sense (piloting and mechanic skills really don't fit); most skills tend to be in the Technical category.

Habitat: Any. Prefer mountains. Found in the Nightlands and occasionally on Earth and other dimensions.

Enemies: Large predators, the Nightlords and their minions.

The Lizard King

The Lizard King (an old name which amuses modern Nightbane to no end) appears to be a mutated form of the Komodo Dragons from Earth, although they must be a different species altogether. For one, the Lizards are supernatural creatures that do not need food or drink in the normal sense. Instead, they are psychic vampires that gain nourishment from the death-agonies of living beings. The creatures can survive a long time without "food" (1D4 months) or can live indefinitely off the P.P.E. energies of a ley line or nexus point. As a result, they are most often found lurking near those places of magic in the Nightlands and occasionally on Earth.

They hunt any and all living creatures and are too ferocious (or stupid) to fear anything. Hunter patrols always make a point of slaying Lizard Kings on sight. There are some legends of a tribe of humans in the Waste that somehow managed to tame Lizard Kings and now use them as war mounts, but no proof of this has ever been found.

Alignment: Considered to be diabolic.

Attributes: I.Q. 1D6 (animal intelligence), M.E. 2D6, M.A. 2D6, P.S. 2D6+29. P.P. 1D6+15, P.E. 2D6+17, P.B. 2D4, Spd. 1D4×10. Supernatural Strength and Endurance.

Size: 12-20 feet long (3.65 to 6.1 m).

Weight: 1 to 1.5 tons (906 to 1360 kg).

A.R.: 12 against normal weapons; zero against magical/supernatural attacks.

S.D.C.: 2D6×10+100

Hit Points: 1D6×10+20

Horror Factor: 11

P.P.E.: 6D6

Natural Abilities: Feeds on P.P.E. energies (lose 1 P.P.E. point for every week spent without feeding, unless it remains within a mile of a ley line or nexus point). Heals damage at the rate of 1D4×10 S.D.C./hit points per minute (4 melee rounds). Nightvision 1000 feet (305 m), fair day vision, and a good sense of smell (54% to track by smell).

Combat: Supernatural. Four attacks per melee round.

Bonuses: +2 on all perception rolls, +3 to strike, +4 to dodge, +3 to save vs magic, +3 to save vs psionics, +9 to save vs Horror Factor. Does not include attribute bonuses.

Damage: Bite inflicts 5D6 S.D.C., kick 3D6 S.D.C., tail swipe 4D6, head butt 2D6 or body ram/trample does 5D6 S.D.C.

Magic: None

Psionics: None

Average Life Span: 40 years.

Languages: None

Habitat: Any; favors areas around ley lines.

Enemies: The minions of the Nightlords who hunt them; tends to prey on most life forms.



The Nightlords

"In ancient times, when the first cities made of sun-dried brick rose in fertile lands that today are little more than deserts, the Ba'al rose to power. They were powerful sorcerers, the first among the early shamans to carve their knowledge in stone tablets, the better to preserve it. But their incantations, which helped bring rain over much-needed crops and healed the sick, were not enough for them. They grew hungry for more power, as is often the way of man. Their craving for knowledge led them to perdition.

Chief among the Ba'al was a sorcerer-king called Molek. At first, he was a wise and learned man under whom a city unlike any other grew. Great towers were raised in his name, and thousands lived under his rule. But the desire for power also festered in Molek. He used new magicks (some say they were in reality, not new at all, but older spells that existed before Man walked the Earth), and called upon alien powers from other worlds. And his call was answered, and Molek walked the Earth no more. In his stead rose Moloch, something far greater, and far baser, than any human that ever lived. For Moloch needed the life of others to live and to feed his power.

Moloch was but the first. His acolytes, servants and lovers became beings like himself, and they ruled their cities mercilessly. In the name of Moloch and the Ba'al, families had to give up their firstborn. The young victims were cast alive into the flames, so their dying agonies could feed Moloch and his kind. And everywhere, humans wailed and gnashed their teeth, seeing their children used thus. A man's life years came and went, and still the Ba'al ruled and slew as they saw fit. Their cities multiplied and new peoples were brought under their sway.

But other Powers were arrayed against the Ba'al, and a great war broke out among the cities of the Ba'al and those who would not give up their firstborn to be cast alive into the flames. Savage was the war, fought with bronze spears and magic, with winged chariots that soared flaming into the sky, and mighty spells that laid waste to whole cities. Mighty heroes came to grips with monstrous horrors summoned from the Netherworld by the Ba'al. The first Guardians, came down from the sky, and brought skyfire down upon the city of Moloch. And the slaughter was great.

The Ba'al and their kind were brought low by the Powers arrayed against them. Their hosts were slain, their monsters banished. And, facing destruction, the Ba'al escaped through the Mirrorwall, unto the Nightlands. And safe in the darkness, they wailed and gnashed their teeth, to see their mighty cities torn asunder, their armies hewed down, their power lost.

In the Nightlands dwelt the Formless Ones, who had never found a shape of their own. And the Ba'al came upon them, and used their magicks to enslave and slay them. And some Formless Ones were fashioned into warrior monsters, and others forced to take the form of men on Earth, to better serve as slaves, and still

others were slain or cast out. And the Ba'al became the Ba'al-ze-Neckt, the Lords of Night."

—Excerpt from The Wanderer Diaries

Other than mysterious ancient writings and legends like the above excerpt, little is known about the Nightlords, also called the Ba'al, Ba'al-ze-Neckt, the Lords of Night, and the Rulers of the Nightlands. The Ba'al reign over sprawling cities in the Nightlands as tyrannical kings and queens feared by all the inhabitants of their domains. Some believe them to be demons, supernatural intelligences, or worse. Others think they are products of humankind's worst traits, living embodiments of hatred, fear and greed. Some have even suggested that they were once human sorcerers who became trapped and warped by the Nightlands, but such speculation is unlikely. They are known to be immortal or at least ageless. They are a diverse group of beings, many of whom bear long-lasting enmities against each other. The only thing they have in common is their evil nature and their immense power.

The most disconcerting fact about the Nightlords is that they look like normal (even attractive) men and women. Even the Nightbane Talent to *see truth* will not reveal any ugliness, deformities or insight beyond their loathsome, evil auras. A few have used their powers to change their shapes into monstrous forms, but this is a conscious choice, not a manifestation of their nature. However, any outer appearance belies the true horror that dwells inside these ancient monsters. The Ba'al are psychic vampires. To them, humanity is so much cattle to be butchered, broken, tamed and devoured at their whim. The Nightlords hate Humankind and all its works. Their great city-states are designed to mock and twist everything humans have accomplished. Given the chance, they will deform the Earth, and possibly destroy it.

Although the Nightlords have human forms and physical shapes, it is not known if they can be killed or destroyed. Although it is believed that a Nightlord who is imprisoned away from sources of psychic energy will die, imprisoning a being who can manipulate matter, energy and their own bodies is nearly impossible. Destroying their physical body may only temporarily weaken them. Only one thing is certain, the Ba'al fear the Nightbane, and wish them all destroyed. Perhaps the Nightbane can physically kill these creatures. Some very rare artifacts are said to have the power to utterly destroy the Nightlords and many Nightbane factions feverishly search the Earth and the Nightlands in the hopes of finding such weapons. In the years following the Dark Day invasion, a few bands of Nightbane have claimed credit for the deaths of several Nightlords. These claims may be exaggerations, lies or misunderstandings (sometimes the Nightbane actually destroy an Avatar of a Nightlord and mistakenly believe they have killed the real Ba'al). And the Nightlords are an ancient group well versed in the arts of trickery and deceit. Their "death" might be a ruse, perfect to later surprise rival Nightlords or other enemies. However, it is also possible that some Factions have indeed slain a few of these ancient abominations.

Nobody is sure how many Nightlords exist. There is typically one to five at each major city in the Nightlands (multiple Nightlords at one city typically means one powerful tyrant and 1D4 lesser Nightlords), so there must be hundreds, or maybe even thousands. Even accounting for the Nightlords who rule over more than one city, especially since some use dispossessed

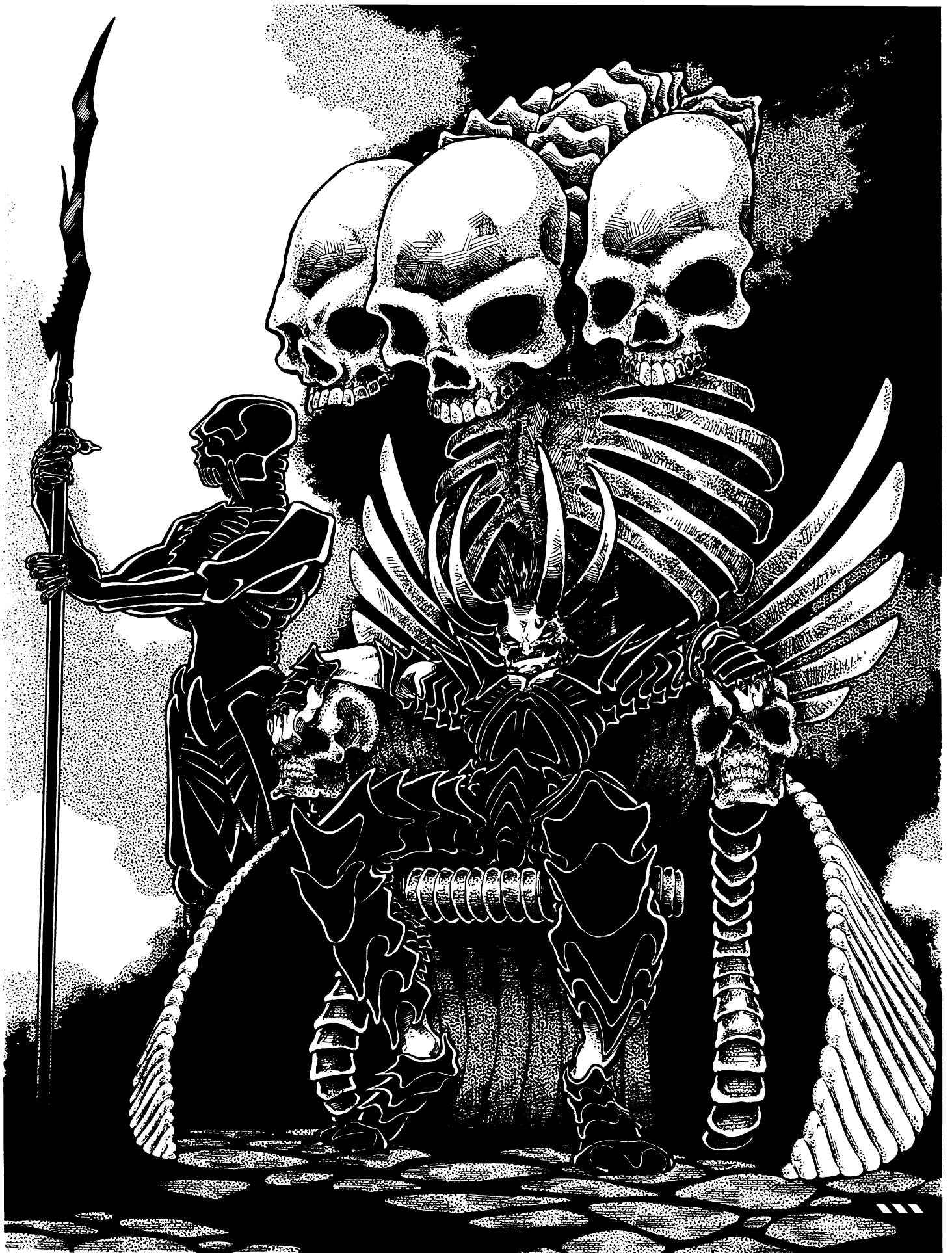

Nightlords as their delegates. The ancient legends indicate that the first Ba'al were relatively few in number, perhaps less than a hundred all told. Yet, they have somehow grown in numbers over the centuries. There are a few rumors that indicate that the Nightlords can reproduce in some arcane fashion; maybe sometimes their Avatars become independent, or perhaps the **Night Princes** grow in power until they become true Ba'al. More likely, they have been "recruiting" new members on Earth from among the ranks of sorcerers and cultists. The process seems to take a long time, however; the "youngest" known Nightlord is said to have crossed over in 1,200 B.C. Most of them appear to have become Ba'al as far back as 10,000 years ago, the times when the earliest cities were built (the oldest *known* city in archeological records, Jericho, was built sometime in 9,000 B.C.).

In most **Nightbane** campaigns, Nightlords and even their Avatars should be seldom, if ever, encountered directly. They are the arch-villains of the world, and even the most experienced and powerful Nightbane bands would be almost hopelessly out-matched. An entire campaign could lead to a climactic duel with a Nightlord after the characters somehow managed to evade or overcome the many layers of defense between the creature and his enemies. More likely, the most the Nightbane can hope to accomplish is to hinder the Nightlords' plans, and perhaps force them to return to their dark world. Whatever the possible outcome, it will be a long, hard road fraught with danger, treachery and subterfuge.

The Powers of the Nightlords

The Ba'al do not bother to learn magic spells; they see magic as a cheap, crude way to manipulate reality — an art beneath their contempt. Instead, the Nightlords can manipulate matter, energy and the mind at will! They are limited only by the psychic energy (P.P.E.) needed to effect the transformations by their own imaginations and force of will. Through the use of their powers, they have built their great cities, created such servant races as the Hounds and Hunters, and even given life to lesser versions of themselves, the Avatars. These powers render the Nightlords nearly invulnerable against conventional weapons and even magic spells.

Besides the powers over physical reality, the Nightlords are linked to the thoughts and emotions of Humankind. They obtain much of their power from this psychic link, and it may have been the desire to strengthen this link that motivated the Dark Day invasion. The Nightlords are able to enter the dreams of sensitive humans, sending their **Astral Avatars** (see below) to disturb, frighten or sometimes recruit the occasional mortal. The Ba'al are instinctively attracted to large human gatherings, so it is no coincidence that the great cities of the Nightlands are in the same place as the ones on Earth. For millennia, the Nightlords have fed on the P.P.E. "run-off" coming from Earth into the Nightlands.

The Avatars

The Nightlords have the ability to create avatars, semi-independent creations that share the same personality and thoughts of their creator. This may be a more powerful version of the Splittin' Image Nightbane talent (see the **Talents Section**) or a separate power altogether. Avatars are not as powerful as their creators, so they can be more easily destroyed. Yet they are still very powerful, able to fight and destroy most lone Nightbane

and to stand against a whole band of supernatural beings. Avatars are used as war leaders, spies and representatives. They can be shaped in any way the Nightlord desires. Many world leaders (including president Douglas Carson) have been replaced by an Avatar of the Nightlords.

There are two types of Avatar. *Physical Avatars* are solid beings made of supernatural flesh and bone. *Astral Avatars* are creatures of pure psychic energy, able to enter dreams and minds. Both are incredibly dangerous and as evil and intelligent as their creators. Astral Avatars are the equivalent of the creation of the Astral Projection psionic power, but it is not linked to the Nightlord via the "silver cord" and is fully independent, able to travel in the Astral Plane, coexist with the physical plane, and contact beings in other dimensions or worlds.

When creating an Avatar, the Nightlord bestows upon it some of his own life force. This gift does not harm or diminish the Nightlord unless the Avatar is somehow killed. Destroying an Avatar is painful and severely weakens the Nightlord. When one of his Avatars is destroyed, the Nightlord loses the equivalent of all the Avatar's S.D.C., hit points and P.P.E.! This damage is healed very slowly (1 point each every hour). Most Nightlords do not make more than two or three Avatars, because if they create too many, and they are all destroyed, the resulting backlash might be enough to kill the Nightlord! For that reason, most positions of leadership are left in the hands of the **Night Princes** or other minions.

Nightlord R.C.C.

Note: Nightlords are NPC villains; power and their thoroughly corrupt nature make them totally unfit as player characters.

The attributes in parentheses are typical for Avatars.

Natural Abilities of the Nightlords:

1. Supernatural Abilities: Despite their usual human appearance, the Nightlords are supernatural beings. They regenerate damage at an amazing rate of 20 S.D.C./hit points at the end of every melee round! Their Avatars heal 2D6 S.D.C./hit points per melee round.

Both the Nightlords and their Avatars take only half damage from all non-magical weapons and attacks (both physical and energy; magic does full damage). They have incredible senses and are able to see the invisible (and through any masking, camouflage or illusionary powers), sense ley lines and nexus points (range: 1 mile/1.6 km per level of experience) and have perfect nightvision (can see in total darkness, range 2000 feet/610 m). Although Nightlords can pass as normal humans, they can, at will, "unmask" their supernatural aura. This aura automatically causes mere mortals to save versus a Horror Factor of 18 as they sense the immense power and evil emanating from the Nightlord.

2. Life Force Vampirism: The Nightlords are energy vampires who do not need normal food or water to survive. Instead, they depend on the life force of living things. Humans and Nightbane are the best source of sustenance; the denizens of the Nightlands are, in the words of a Nightlord, "weak and foul-

tasting,” enough to keep a Nightlord alive but not happy. Nightlords prefer their “food” to be flavored by pain and terror. Therefore, their favorite form of feeding consists of torturing victims to death. The traditional way to offer a sacrifice to the Nightlords is to throw a live victim into a large bonfire! This feeding process requires a helpless victim; Nightlords cannot feed in combat.

The feeding process takes one minute. Up to 50 hit points or P.P.E. can be absorbed during that minute. Human and Nightbane hit points and P.P.E. replenish the Nightlords’ needs on a one to one basis (i.e., one hit point or P.P.E. stolen from a human or Nightbane will grant the Nightlord one P.P.E. point of sustenance). On the other hand, Doppelgangers, Hounds and Squires used in this manner only “produce” one P.P.E. point for every 10 hit points or P.P.E. absorbed. The Nightlord needs to consume a minimum of 20 P.P.E. in this manner every day. If not, those 20 P.P.E. are subtracted from the monster’s energy base, reducing it 20 points every day until it can be replenished. Since most Nightlords have at least 1,000 P.P.E., they could survive almost two months without feeding, but their power would diminish enormously. When their P.P.E. base is reduced to zero, they lose 1 P.E. point per day; if P.E. is also reduced to zero, the Nightlord will crumble into dust. It is *possible* that this will not truly destroy the Nightlords and they can return to life if the energy becomes available and the conditions are right.

Nightlords who fall dangerously low in power function at half their normal capacity (half attacks per melee round, half S.D.C., half bonuses, and half speed). To replenish themselves quickly, they may engage in a frenzy of torture and murder, gorging on hundreds of P.P.E. and hit points every day until back to full strength or an acceptable level. Most try never to fall into such a state of dereliction.

3. Matter and Energy Control: The Nightlords have powers over inanimate matter and energy that transcend normal magic and psionic powers. They are said to be able to control reality itself; this is a bit of an exaggeration. However, by using P.P.E. they can reshape, alter, melt and destroy inanimate objects at will.

They can also use rituals, willing participants, unwilling sacrifices, mass slaughter, ley lines and ley line nexus to produce additional P.P.E. to be harnessed and used to reshape or destroy matter. Given enough time and power, Nightlords can create or destroy entire cities!

Each use of this power counts as two melee attacks/action, requires line of sight to be used (with a maximum range of one mile/1.6 km).

Note: Living beings are immune to this power. This includes “biomechanical” Nightbane and cybernetic systems attached to and/or implanted in living beings (for that matter, anything covered or contained inside living matter).

Magical weapons and artifacts are also unaffected by the Nightlords’ powers.

The following abilities fall under this incredible power:

Reshape Matter: The Nightlord can mold inanimate matter (metals, stones, and any mineral or synthetic substance) at will as if it were soft clay. The cities of the Nightlords were built in this way. The shape can be anything the Nightlord desires; i.e., he can twist a gun into a pretzel, but the matter’s structure re-

mains the same — the pretzel will still be made of metal). **Cost:** One P.P.E. per 5 pounds (2.3 kg) of matter.

Melt Matter: The Nightlord causes solid matter to assume a liquid state. In the case of most metals and solid minerals, this means the matter will become incredibly hot! Any matter will suddenly heat to its “melting point.” Anybody holding a metal object thus melted will take 3D6 S.D.C. burn damage (2D4×10 if body armor or a vehicle is melted on top of the character). **Cost:** One P.P.E. per pound (0.45 kg) of matter (so melting a two ton car costs 4000 P.P.E. points).

Transform Matter: This aspect of the power allows the Nightlord to change lead into gold, plastic into iron, etc., and vice versa! They can transform guns into candy, and wine into nitroglycerin. **Cost:** 20 P.P.E. per pound (0.45 kg) of matter transformed. The transformation is permanent, unless the fiend spends energy to change it back. Remember, living beings and organic matter cannot be affected.

Matter-Energy Meld: Nightlords can “attach” matter and energy to their own bodies, giving themselves monstrous but very powerful shapes. Each 10 P.P.E. spent in this manner will add 20 S.D.C. to the Nightlord (usually in the form of metallic armor, rocky growths, and so on). Also, the Nightlords can surround themselves in an aura of fire, crackling electricity, or other forms of energy. These energy auras provide 10 S.D.C. worth of protection for every 10 P.P.E. spent. Furthermore, the energy will burn anyone who touches or comes within 10 feet (3.0 m) of him. Damage is equal to 1D6 for every 10 S.D.C. spent. The Matter-Energy Meld lasts one hour; at the end of it, the Nightlord can spend more P.P.E. to renew it.

This power can also be used to make himself invulnerable to all forms of energy attack, except magic, at a P.P.E. cost of 10 points per every 10 minutes.

Or the supernatural power can use energy (fire, electricity, lasers, etc.) to make himself more physically powerful and giant-sized by converting the energy into mass. Every 10 points of energy/S.D.C. damage actually gives the Nightlord one additional S.D.C. point, one pound of mass, and six inches (0.15 m) in height. Thus, enduring a total of 100 points of damage from energy blasts or fire, etc., increases the monster’s S.D.C. by 10 points, mass by 100 pounds (45 kg), and height by three feet (0.9 m). 1000 S.D.C. points of damage would be 10× that amount. However, the Nightlord must expend 5 P.P.E. points for every 10 points of energy funneled into his system, so 1000 S.D.C. energy damage will cost him 200 P.P.E. points.

Disperse Energy: Nightlords can disperse energy harmlessly around themselves. Fire, heat and radiation can be rendered useless against them. It is said that a Nightlord with enough power available could dance unharmed in the corona of a star, or withstand a nuclear explosion! One hopes these are exaggerations. **Cost:** Every 10 P.P.E. points expended will harmlessly disperse up to 100 S.D.C. points of energy/S.D.C. damage. 1000 points can dispel 10,000 S.D.C. points of energy damage. This effect lasts for one minute after the power is activated. **Note:** Does not affect magical and psionic energies, including Nightbane Talents and the Guardians’ energy powers.

Release Energy: This power enables the character to unleash large amounts of pure energy in the form of fire/plasma, electricity, or light/laser blasts. These energy *blasts* inflict 1D6 S.D.C. per every 2 P.P.E. spent. **Cost:** 2 P.P.E. per die of damage (i.e., a

blast doing 4D6×10 S.D.C. would cost 80 P.P.E.). The Nightlord is at +3 to strike with these blasts.

The Nightlord can also create walls of fire, circles of fire, electrical fields, electro-magnetic fields, etc. **Cost:** 10 P.P.E. per 20 foot (6 m) radius (those who try to pass through the energy wall or field suffer 6D6 damage). Likewise, the villain can create the equivalent of the following spells at a cost of four P.P.E. each, at 10th level power! Globe of daylight, blinding flash, ignite fire, fuel flame, fire bolt, extinguish fire, circle of flame, and energy disruption.

Manipulate Dimensional Energies: The Nightlords can also control dimensional energies, such as what is needed to open and close Rifts, open dimensional portals, teleport, and so on. All Nightlords have the equivalent of the spells, Close Rifts, Dimensional Portal, Teleport: Superior, Fly, Float in the Air, and Time Slip. **Cost:** Same as each respective spell.

Telekinesis: Basically the same as the spell, only the range, weight, duration, and damage are increased 10. **Cost:** ×10 P.P.E.

4. Sense Dimensional Disturbances: Nightlords are attuned to mystical energies, and can sense the presence/appearance, opening and closing of Rifts, dimensional portals/doorways, teleportation spells, dimensional anomalies, and similar magical/supernatural effects, at a range of 5 miles (8 km) per level of experience.

5. Breach the Mirrorwall: Before Dark Day, the Ba'al were imprisoned in the Nightlands. Only their minions or astral Avatars could visit the Earth, and the former only if they were summoned by evil magicians. The resulting effects of that day have allowed them to escape their ancient prison, and to send out their minions in great numbers. The Nightlords can cross the Mirrorwall by spending 10 P.P.E. and concentrating for one minute (4 melees rounds). This power cannot be used in combat. Also, the Nightlord can send any number of minions to Earth by spending 5 P.P.E. per minion. This process also takes one minute (4 melees).



Alignment: Any evil (most are Diabolic).

Attributes: I.Q. 3D6+12, M.E. 3D6+12, M.A. 3D6+12, P.S. 3D6+30 (3D6+20), P.P. 2D6+16 (2D6+14), P.E. 3D6+12 (2D6+12), P.B. 3D6+6 (varies), Spd. 1D6×10 (1D4 x 10). The mental attributes of the Avatar are the same as the Nightlord.

Size: Varies, typically within the human range.

S.D.C.: 3D6×100+500 (1D4×100+100 for the Avatars)

Hit Points: P.E. times the level of experience! (P.E. plus 1D6×10 for the Avatars)

Horror Factor: 18 when they unmask their aura of fear and power (14 for the Avatars).

P.P.E.: 2D6×100 +1000, plus 50 per level of experience (1D6×100 +20 per level of experience for Avatars).

Combat: Typically Hand to Hand: Martial Arts or Assassin.

Damage: Supernatural Strength. Also see powers, above (see the **Supernatural Strength Table**).

Bonuses: +3 on initiative, +5 on all perception rolls, +1 to parry and dodge, +4 to roll/pull punch, +6 to save vs magic, +10 to save vs horror factor. These bonuses do not include skill or attribute bonuses.

Magic Powers: Ample knowledge in the use and limits of magic. Nightlords used to be sorcerers, but disdain the use of magic, preferring to rely on their powers over matter and energy.

Psionic Powers: None, other than the formidable natural abilities listed previous.

Average Life Span: Unknown, presumed to be immortal.

Experience Level: Average 2D4+5. An Avatar will typically be half that level.

Vulnerabilities/Penalties: Nightlords and their Avatars take triple damage from all attacks at the hands of Nightbane and Guardians, and double damage from attacks from any other supernatural creatures (including vampires and wampyrs).

R.C.C. Skills: Occult Lore and knows all languages at 98% (many will be ancient/archaic tongues), most Nightlords will also have 10-20 additional skills at +20% from any skill category due to their centuries of life experience.

Alliances and Allies: Each Nightlord commands an army of *at least* 100 Hounds, 10 Hunters and 10 Hollow Men and 5-10 Ashmedai. The average Nightlord commands ten to twenty times as many troops, and the more powerful ones ten to twenty times above the average!

Weapons and Equipment: Some Nightlords wield ancient artifacts and/or magic weapons and armor, but most of them disdain the use of weapons (unless extremely powerful), preferring to rely on their own powers.

Ba'al-Zebul R.C.C.

The Night Princes (aka Squires)

The chief lieutenants of the Nightlords are the Night Princes (or Ba'al-Zebul). They are human-looking beings with incredible powers of illusion. Some ancient writings refer to both the Nightlords and their "princes" or "squires" as the Ba'al. Perhaps the Ba'al-Zebul are lesser Nightlords, or valued servants who have been "gifted" with the power to deceive and confuse men.

For millennia, the Night Princes have crossed over to Earth to manipulate, abuse and control humans. They helped keep the *Cult of Eternal Night* alive on Earth, and fooled hundreds of mortals into secretly worshipping the Ba'al. Some of the legends about tempting demonic beings may be related to the Ba'al-Zebul's activities. Their main purpose is to fool Earthlings, since most of the Nightlords' other minions are immune to illusionary powers. Their abilities and human-like appearance make them ideal agents and infiltrators. A few Ba'al-Zebul on Earth are

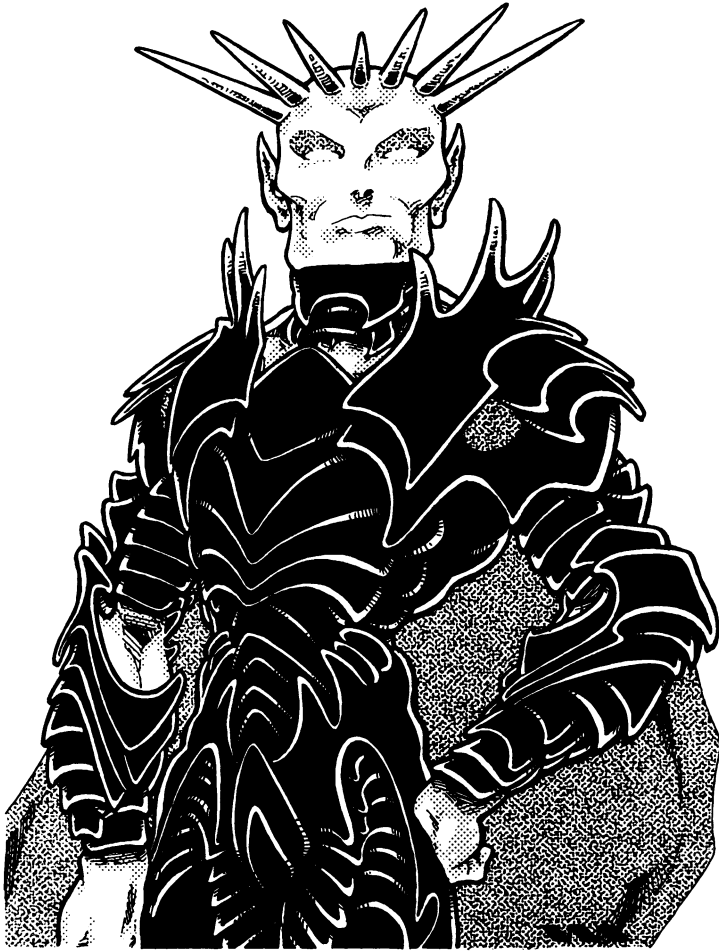

masquerading as movie stars, wealthy jet-setters, corporate officers, political advisors and other high-society types. They often started Cults of Night among the rich and powerful, promising jaded socialites enormous power and pleasures. A number of Night Princes manipulated hundreds of powerful humans into supporting the Preserver Party and other Nightlord-controlled groups throughout the world. They continue to establish themselves in key positions to help the Nightlords' takeover of the planet. The Ba'al-Zebul are also used as war leaders, and have a higher rank than all other minions except the *Avatars* of the Nightlords.

A few Ba'al-Zebul have gone renegade, usually because their power-hunger has prompted them to betray their overlords. These renegades are no less evil than the Ba'al, just less powerful. They often take control of a cult or some secret organization, or peddle their services as mercenaries or try to ingratiate themselves with rival Nightlords and supernatural powerhouses in exchange for more power. There are rumors that some Night Princes actually have turned against the Nightlords and their plans.

G.M.'s Note: It might be possible to allow player character Night Princes. However, this is discouraged for a number of reasons. Although the Night Princes are not overwhelmingly powerful compared to Nightbane, their twisted, self-serving nature (they are energy vampires, after all) and their terrible reputations will make them difficult to fit in most *Nightbane* campaigns. Most *Nightbane* and human factions will destroy Night Princes on sight, as will vampires, wampyrs and guardians.

Night Squires are typically low level Night Princes who have yet to distinguish themselves.

Natural Abilities of the Night Prince or Squire:

1. Supernatural Attributes: The Ba'al-Zebul are inhuman beings who heal damage at the supernatural rate of 1D4×10 S.D.C./hit points every minute/4 melees, and have the following abilities: see the invisible and all illusions (including those created by another Night Prince), impervious to mind control of any kind, nightvision (range: 500 feet/152 m), sense the presence of ley lines and nexus points (range: 1 mile/1.6 km), and does not need to eat, drink or breathe air.

2. Energy Vampires: Like their masters, the Night Princes are energy vampires who need to feed on the life force of other living beings. Five hit points or P.P.E. a day will keep a Night Prince "fed," although they will not feel happy and truly satisfied unless they consume at least 10-20 a day. Every time the fiend misses a "meal," he or she loses 1 P.P.E. point, which can only be restored after getting an extra 5 P.P.E./Hit points the next time he/she feeds. When P.P.E. is reduced to zero, the Ba'al-Zebul loses 1 Physical Endurance (P.E.) point and crumbles to dust when his/her P.E. is reduced to zero.

3. Illusionary Powers: The Ba'al-Zebul are masters of creating constructs of magical energy. These constructs are not real, but can be convincing enough to deceive, terrify and even harm victims. Each illusion costs different amounts of P.P.E. depending on how powerful, large or effective the illusion is. Some examples of illusions and their P.P.E. cost are given below. The Game Master can use them as guidelines to determine other illusions and P.P.E. costs. The range for these powers is 100 feet (30.5 m) plus 20 feet (6.1 m) per level of experience. The size of an illusion is equal to 10 cubic feet (0.3 cu m.) per level of experience.

All these illusionary powers can be resisted and seen through with a save against magic, but only when the target/victim has a reason to suspect the illusion is not real. To sense whether or not something is not "right" with the illusion, a *perception roll* can be attempted. The more involved illusions (those affecting at least three senses) are the hardest to resist, make a Difficult Perception roll or worse; the G.M.'s discretion.

Sound and minor (soundless) visual images cost only 2 P.P.E. per minute, and affect everybody in auditive or visual range.

A combination of sound and image, or an illusion of smell costs 5 P.P.E. per minute (4 melee rounds).

Image, sound and odor combined, or an illusion of touch (including temperature and texture) costs 10 P.P.E. per minute.

Full sensory illusions (combine all five senses); costs 20 P.P.E. per minute (4 melee rounds).

An entire panorama affecting an area equal to twice the normal size, and with full details, such as a forest complete with images, sounds and odors. Costs 60 P.P.E. per minute (4 melee rounds).

Horror Factor of any illusion has a base H.F. of 10, +1 for every 3 additional P.P.E. points spent (this is in addition to the illusion cost). The maximum Horror Factor for any such illusion is 18. For example, a Night Prince wishing to create a demonic entity that affected all 5 senses and had a Horror Factor of 18

would have to spend a total of 44 P.P.E. per minute; 20 for the illusion proper and 24 for the +8 to Horror Factor.

Death by Illusion: Although the illusions will not normally cause damage, an extremely convincing illusion may cause a person to believe he has been killed or severely injured! As long as the character does not see through the illusion (Game Masters should do their best to ensure the *players* don't realize their characters are fighting an illusion), their character will appear to take damage as normal and the illusion is likely to even show damage to the character's armor and body (only illusions affecting all five senses will produce these effects). If the character believes he has been reduced below zero points, he will fall unconscious from traumatic shock! His condition is so severe that the character will lapse into a coma and may die unless he receives medical treatment! However, the character is +10 to save vs coma and will recover at full strength (minus any real damage he/she may have suffered). Game Masters might require a roll to save vs insanity (10 or higher; add M.E. bonuses and any bonuses to resist Horror Factor) for the character to avoid lasting mental consequences as a result of the traumatic experience.

Night Prince R.C.C.

Alignment: Diabolic or Miscreant. There are stories of a few renegades who turned away from the Nightlords and now are fighting them. At the Game Master's discretion, these rumors may or may not be true.

Attributes: I.Q. 3D6+6, M.E. 3D6+6, M.A. 3D6+6, P.S. 3D6+10, P.P. 3D6+4, P.E. 2D6+18, P.B. 3D6+6, Spd. 5D6

Size & Weight: Normal human.

S.D.C.: 2D4×10 +120

Hit Points: P.E.×2 plus 2D6 per level of experience.

Horror Factor: 9, but can create illusions with an H.F. of up to 18.

P.P.E.: 1D4×100 plus 15 per level of experience.

Combat: Equivalent to Hand to Hand: Assassin, with one additional attack per melee round at level one.

Damage: As per supernatural strength (see the **Supernatural Strength Table**).

Bonuses: +1 to parry, +2 to dodge, +2 to roll with punch, fall or impact, +5 to pull punch, +4 to save vs magic, +3 to save vs psionics, +5 to perception rolls, and +6 to save vs horror factor.

Magic Powers: Natural illusion powers only. Many Night Princes pretend to cast magical spells which are in reality, illusions, and can easily replicate any illusionary spell effects.

Psionic Powers: None

Average Life Span: Unknown; presumed to be immortal.

Experience Level: Average 1D4+4.

Vulnerabilities/Penalties: Night Princes take double damage from the attacks and Talents of the Nightbane, and from the energy powers of the Guardians.

R.C.C. Skills: The typical Night Prince knows Occult Lore (+20%), speaks 8 languages at 98% (due to their great age), and know an additional 10 skills (from any category, but must include prerequisites) at +10% and an additional 12 secondary skills.

Alliances and Allies: Night Princes are often placed in command of Hound Masters, Hollow Men and Ashmedai. Others lead entire armies of minions of the Nightlords.

Weapons and Equipment: Vary with mission and situation.

Priest of Night O.C.C.

NPC Villain

The Priest of Night is a human fanatic who willingly worships the Nightlords in return for magical powers. Most of these cultists are outcasts from society, often too ugly or unappealing (physically or spiritually) to make friends, or who somehow are unable to socialize and deal with normal life. They end up hating themselves, their place in the world, and society at large. Their rage is such that they are willing to sacrifice a degree of their humanity in order to gain the power they think they need to get their revenge or prove themselves. Typically, the would-be Night Priests are contacted by the Astral Avatar of some Nightlord or by a Night Prince. If the candidate seems receptive to manipulation, a mystical pact is forged between the Ba'al and the human.

Soon, the cultist becomes able to use magic and gains a number of other special abilities. The once-rejected misfit will suddenly become extremely charismatic, as well as inhumanly strong and tough, far more powerful than he ever hoped to be. Most Priests of Night are pathetically grateful to their "benefactors" and do anything that's asked of them without complaint or hesitation. Soon, the Night Priest finds himself or herself committing murder, larceny or even worse crimes in the service of the Ba'al.

The origin of the magical powers of the Night Priests is unknown. Since the Ba'al themselves do not have magical powers, it is not certain what the source of this mystical energy is. Some occultists theorize that the magical powers emanate from the true master of the Nightlords, an alien intelligence of unimaginable power that the Ba'al worshipped back when they were mere human sorcerers. In any case, the Night Priests played a very important role in the advent of Dark Day and the invasion that followed.

O.C.C. Abilities and Bonuses:

1. The Gift of Power: The Night Priest always becomes powerful both physically and psychologically. His Mental Affinity and Physical Beauty are each increased by 8 points or raised to a minimum level of 18 (whichever is higher). His P.S. is increased by 4, and his P.P. by 2. Furthermore, by spending 2 P.P.E. per minute, the Night Priest's strength becomes superhuman, able to inflict massive amounts of damage with his bare hands. Add 30 points to S.D.C. and 3D6 to Hit Points.

2. The Gift of Magic: At first level, the Night Priest gains eight spells from levels 1-4. At every subsequent level of experience, the priest can select one additional spell from levels 1-5 until reaching 6th level, at which point can learn any spell of an equal or lower level. The Night Priest has full access to any spell dealing with the Nightlands, the Nightlords, or their minions. **P.P.E.:** 1D6×10 plus the P.E. attribute. Gains 2D6 P.P.E. per level of experience.

Priest of Night or Night Priest R.C.C.

Attribute Requirements: None. Most are diabolic or miscreant in alignment, or soon become one of these alignments as they are corrupted by their masters.

O.C.C. Skills:

Native Language 98%
 Nightlands Lore (+20%)
 Dancing (+15%)
 W.P. Knife

Hand to Hand: Basic

Hand to hand: basic can be raised to hand to hand: expert at the cost of one “other” skill, or to martial arts or assassin at the cost of two “other” skills.

O.C.C. Related Skills: Select ten other skills. Plus select one more skill at levels three, six, nine and twelve.

Communications: Any

Domestic: Any

Electrical: None

Espionage: Any

Mechanical: None

Medical: First Aid only.

Military: None

Physical: Any

Pilot: Any

Pilot Related: Any

Rogue: Any

Science: Any

Technical: Any (+5%)

W.P.: Any

Wilderness: Any

Secondary Skills: The character also gets to select six secondary skills. These are additional areas of knowledge that do not get the benefit of the bonuses listed in parentheses.

Standard Equipment: Will own at least a car and several weapons, including a sacrificial knife. Many end up owning a nice house or mansion which they use as a base for their cult. They are typically surrounded by 3D6 normal human cultists (see NPCs in the Campaign Section).

Money: 4D6×1000 in cash and 2D6×100,000 in property.

The Vampire Threat

By C.J. Carella & Kevin Siembieda

Hugh Jefferson was having a real bad day.

He had walked into the alley with the innocent intention of crawling behind the dumpster, finishing off the bottle he was hugging against his body, and spending another night trying to dream his world away.

Something was waiting for him.

Thin, pale limbs with inhuman strength grabbed and smashed him against a wall. Through tears of fear and pain, Hugh saw a smiling man effortlessly holding his two hundred pounds of fat and dirt in the air. The stranger’s mouth revealed enormous fangs. Hugh had seen enough movies in his life to know what was going to happen next.

“Let him go,” a soft voice said at the end of the alley.

The vampire hissed and dropped Hugh, turning around to meet the voice.

Hugh knew the newcomer. Sara Li. A small Asian girl who wandered the streets. He wasn’t sure whether she was a hooker, an addict, a dealer or just another runaway, but she had always been nice to him. Now she was standing up to this monster. “Sara! Run!” he gasped, surprised at his own words.

“It’s all right, Hugh,” Sara said. “I can take care of myself.”

“You come here to die,” the vampire said in a voice as harsh as a graveyard whisper.

*“Nope.” Suddenly, Sara Li **changed**. Her face remained the same, but the slim girl wearing the torn stockings, combat boots and Chinese Army jacket was no more. In her place stood a taller, muscular woman, covered with blood-covered nails that protruded from head to toe like some grotesque porcupine. “You can leave or you can die, Vamps.”*

“Fool!” the stranger spat. “We walked the Earth when you and yours were misbegotten nightmares crawling in your shadow world! This realm, and all its creatures, belong to us!”

Sara Li gathered herself. The rusty nails protruding through her skin undulated in waves as she flexed her muscles. “Wrong, bloodsucker. Neither you nor the Nightlords are welcome here.” Then the battle fury overwhelmed her. With a guttural war-cry, she attacked. The two supernatural beings leaped at each other, colliding in mid-air with talons flashing, fangs readied. Screaming in terror, Hugh fled into the night.

Vampires are a powerful variable in the war between the Nightbane and the Ba’al. Enemies of humankind and all living things, vampires are also at odds with the Nightlords and their plans of conquest. Should the Ba’al come to completely dominate the Earth, there will be little room for other creatures of the night; they hate vampires and fear Nightbane, so both must be eradicated. With few exemptions (see the **Wampyr R.C.C.**, below, and the **Nocturnes Faction**, described elsewhere), most vampires see humans as little more than cattle. They hate the Nightlords and fight them tooth and nail. They also welcome alliances with Nightbane and other supernatural or magic forces willing to join their battle. However, any potential alliance faces insurmountable obstacles. If the vampires win, they’ll turn Earth into their hunting preserves. Nightbane have close ties to humankind and often consider themselves to be human (or at least half human). Consequently, they are not likely to appreciate the vampires’ view of humans as “meat” waiting to be served up on a platter. If the Nightlords prevail, the vampire threat will be gone, but humankind will be bound to enslaved servitude and



worse. Therefore, vampires often make up a third front of the war, at odds with the other two.

Game Masters can assign varying roles to vampires in their campaigns. If he/she thinks that a new group of supernaturals is going to “clutter up” the campaign, vampires could be rarely, if ever introduced. On the other hand, they can create an additional dimension to the story line. They may appear unexpectedly to help *Nightbane* and even human player characters for reasons of their own, or they may become as much of a threat as the Nightlords themselves. Vampires can be friends, foes, or uneasy allies willing to join forces to combat a common enemy. In fact, different factions are likely to represent all three. Of course, one must always wonder whether a vampire “comrade” is a genuine “friend,” or a friend of convenience who will turn on his allies the moment their usefulness comes to an end. All wonderful elements for a great role-playing campaign.

Vampire Intelligences

“True” vampires have little in common with the suave cloaked seducers of myth and legend. The creators of the Undead races are alien monsters with no physical or spiritual resemblance to humans. Typically, they resemble giant mounds of flesh, covered by writhing tentacles, all surrounding a huge central eye. Most vampire intelligences dwell in other dimensions unrelated to either Earth or the Nightlands. From there, they send disembodied “fragments” of their essences to travel the Megaverse in search of willing slaves. The first vampire accepts

the gift of Undeath “freely and of his own free will.” This *master vampire* in turn, starts infecting other victims and turns them into lesser vampires. When enough vampires are created, the vampire intelligence can manifest itself in that world.

More information on vampire intelligences, their powers and vulnerabilities will appear in future *Nightbane* sourcebooks.

The Vampire R.C.C.s

Master, Secondary and Wild Vampires

There are three “subspecies” of vampire (not counting the rarer Wampyr): the Master, Secondary and Wild vampires. All share a number of powers and abilities, and all are consumed by blood lust and predatorial instincts.

Note: Most of the following information is based on the *Rifts* supplement *Rifts Vampire Kingdoms*. Players and Game Masters wishing to learn more about vampires in the Palladium Megaverse are advised to refer to that book or future *Nightbane* supplements. *Vampire Kingdoms* deals with the possibility of a society completely dominated by the Undead; it can inspire Game Masters wishing to give vampires a greater role in their campaigns.

The Master Vampire

The master vampire is the father of the pestilence to follow. Unlike all other vampires, the master chooses his fate. He is a human or humanoid who willingly accepts a diabolical offer in the name of revenge, power, or pure evil to become an undead predator. The vampire knows full well that from that day forward, he will be an inhuman abomination that feeds on the misery and life’s blood of the innocent. This makes the master vampire the most evil and most like his insidious creator, the intelligence. The transformation from the living to the undead is instantaneous, requiring only a willing soul. Once done, it cannot be undone.

The transformation into a vampire destroys all vestiges of humanity, except for some faded memories and a handful of skills. The master, as are all vampires, is reborn, or perhaps unborn. The transformed vampire no longer has anything in common with humankind, other than the human appearance, and even that appearance is just one of several the vampire can select at will. As a result, the original human attributes and alignment are meaningless, entirely new attributes are rolled, an evil alignment selected, and a handful of skills retained/selected.

The master’s supernatural powers are instinctively known to him. Just as he instinctively understands his place in the hierarchy of vampires and knows that he must create a legion of undead so that the vampire lord (the intelligence) may one day join them to rule the planet. Every vampire the master creates will serve to solidify the vampire intelligence’s essence in this world. The more vampires, the stronger the intelligence’s power, and the master’s as well. When thousands of vampires exist, all born from that first evil essence of the master, the intelligence may enter that world through a dimensional Rift and live among them.



The undead see all humans and humanoids as animals to be hunted down and eaten. The master vampire is the most arrogant and manipulative of all and frequently partakes in games and tests of cunning and power against humanoid challengers. The perceived end to such enjoyable diversions is to prove the superiority of the undead. Defeat and humiliation, especially at the hands of lesser beings like true humans, is an unforgivable blow to the ego and will always require retribution. Thus, a vampire's lust for revenge is as legendary as his lust for blood. One does not begin a conflict against a vampire, especially a master or ancient secondary, unless one intends to see it all the way through to the destruction of the creature.

Master vampires see the Nightbane as dangerous rivals, assuming (mistakenly) that all supernatural creatures wish to prey on humankind. They fear and loathe the Nightlords, who they rightfully see as their main competitors in a race for dominion over the Earth, and as an enemy bent on their destruction. Should either vampires or the Ba'al triumph, there will be no quarter given to the other side. For that reason, master vampires may occasionally see fit to strike alliances of convenience with the Nightbane. However, such alliances are likely to be terminated or betrayed at the first opportunity. A Nightbane who trusts a master vampire is taking a great risk — but sometimes there is no alternative.

Guardians are feared even more than the Nightlords and their minions. To vampires, Guardians are relentless predators who hunt and destroy the undead. Master vampires will never deal with Guardians, and will always attempt to destroy them or, failing that, to flee from their presence. Likewise, Guardians will never consider an alliance with vampires and will destroy them without hesitation whenever they are encountered.

Master vampires are uncommon and are always evil. Thus, they are not recommended as player characters. The master vampire can be male or female.

Alignment: Any evil; radiate supernatural evil.

Attributes: I.Q. 14+2D6, M.E. 10+3D6, M.A. 12+3D6, P.S. 18+3D6, P.P. 10+3D6, P.E. 18+1D6, P.B. 16+2D6, Spd. 10+4D6.

Size and Weight: Varies, generally human.

S.D.C./Hit Points: Vampires are bizarre supernatural creatures that are nearly impervious to all weapons. Fortunately, they are vulnerable to a handful of S.D.C. items and magic.

Hit Point Equivalent: 3D6×10.

Horror Factor: 14, **P.P.E.:** 1D6×10

Natural Abilities: Vampires possess a number of strange supernatural powers, including the ability to create secondary vampires, nightvision, metamorphosis, regeneration, and invulnerability. See the **Vampire Power Section** descriptions that follow.

Experience Level: Average 1D6+1 (2nd to 7th level).

Combat: Six hand to hand attacks per melee. Or can combine psionic attacks (as many as two per melee) with physical attacks, meaning two by psionics plus two hand to hand attacks per melee are possible. Each psionic attack is roughly equal to two hand to hand attacks.

Damage: Vampires are considered to have supernatural strength. See the Supernatural Strength Damage Table to determine the damage it inflicts in hand to hand combat. The vampire's killing bite is 3D6 plus P.S. bonus. This damage affects other vampires; this means one vampire can kill another, although their regenerative powers make this difficult.

Bonuses: In addition to attribute bonuses, +5 to save vs horror factor, +3 on initiative, +4 on perception rolls, and impervious to all forms of mind control, psionic and magic sleeps and paralysis.

Magic Powers: If the master vampire knew magic before being reborn into a vampire he retains that knowledge, but those magic abilities are frozen at the level of his rebirth and can NEVER increase in experience or power. Nor can the vampire learn new magic or increase his personal level of P.P.E. points.

Psionic Powers: Includes mind control over vampires (does not require the expenditure of I.S.P.), and a handful of other I.S.P. based powers. See the psionic power descriptions to follow. Considered a master psionic; requires a roll of 10 or higher to save vs psionic attacks. **I.S.P.:** 3D6×10.

Average Life Span: Never ages. The undead are effectively immune to the ravages of time and always look the age they were when they became a vampire.

Vulnerabilities/Penalties: See the vampire powers section.

R.C.C. Skills: The master vampire retains the knowledge of his former life, but O.C.C. skill bonuses are not applicable (forgotten), only the I.Q. bonus (if any) applies. Skill proficiencies are frozen at the level they were at when the person became a vampire and do NOT increase.

New Skills: Three additional skills can be selected for every 100 years of life as a vampire. All skills are at second level proficiency and do NOT increase. The available skill categories are limited to: Communications, Domestic, Piloting, Technical, Rogue, Wilderness and Weapons Proficiencies.

Alliances and Allies: Tend to associate with their own kind, but may work with Nightbane, ghouls, other supernatural forces, and even humans if it serves their purpose.

Weapons and Equipment: Most vampires disdain the use of weapons and technology. Some of their enslaved servants will use cars, guns and other modern conveniences, but their master will primarily rely on his natural powers.

The Secondary Vampire

An Optional Player Character R.C.C.

The master vampire creates other vampires by a *slow kill* bite that transfers yet another fragment of the evil essence into another humanoid creature. The process, described elsewhere, transforms the master vampire's slow kill victim into a secondary vampire. Tragically, now that the vampire intelligence has anchored itself in the world through the master vampire, it no longer needs to find willing subjects. The master vampire can transform willing and unwilling victims alike into the cursed undead. With the creation of each new vampire, the alien intelligence's hold in that dimension becomes stronger.

The victims of the master are the secondary vampires. Despite the fact that they are usually subservient to their creator and the intelligence, and that the term "secondary" implies a level of inferiority, they possess all the spectacular supernatural powers of the master vampire and are quite intelligent. The only two things that make them inferior to their creator/master is that the secondary vampires are slightly less intelligent, and that they are susceptible to the mind control powers of their master.



Ironically, the secondary vampires can sometimes defy the vampire intelligence, perhaps because they possess a smaller portion of its essence, or because they must answer to two masters. Whether it is the smaller essence or the fact that they are a second generation extension of the intelligence, the pitiful creatures remember more about their lives as humans than any other undead.

Those of evil alignment readily accept their new monstrous existence and are the least tormented by past memories. Those of good alignment frequently loathe the monsters that they have become. Many try to fight the unnatural desires for blood and carnage, but most eventually succumb and resign themselves to an existence of evil as the dreaded creatures of the night. Yet a tiny minority do successfully win their inner battle and retain some vestige of humanity. They are the unprincipled, anarchist and aberrant vampires who tend to operate independent of a master and away from others of their ilk. They seldom feed indiscriminately on the innocent and try to do some good with their lives. They are also the types most likely to be used as player characters.

The plague of evil continues as the secondary vampires feed and/or create additional vampires by means of the slow kill. Because the secondary vampires retain more memories of their pasts than the master or wild vampires, they often target family members, friends, and loved ones as victims of a slow kill. In many cases, the feelings of love are gone, but the shadow of a memory compels them to add these people to their evil brotherhood. Unlike the master, the slow kill of the secondary vampire does not offer consistent results. Again, perhaps because these lesser vampires are not as true to the intelligence's nature or because they possess a smaller essence fragment, they do not automatically create another secondary vampire. There is trouble creating new undead, 58% of the victims of a slow kill bite will be wild vampires, not secondary vampires. See the Vampire's Bite: The Slow Kill, in the Vampire's Powers section.

Alignment: Selfish or evil; radiates supernatural evil. Player characters who are secondary vampires, but try to fight the desire for blood, can be unprincipled good (selfish), but their vampire instincts, cravings and needs make a higher good alignment impossible. Anarchist and aberrant evil secondary vampires are more common than unprincipled.

Attributes: I.Q. 3D6+2, M.E. 3D6+6, M.A. 3D6+6, P.S. 3D6+14, P.P. 3D6+8, P.E. 1D6+16, P.B. 2D6+4, Spd. 3D6+10

Size and Weight: Varies; generally human.

S.D.C./Hit Points: Have the equivalent of 3D4×10 hit points.

See the Vampire Powers Section.

Horror Factor: 12, **P.P.E.:** 1D4×10

Natural Abilities: See Vampire Powers Section.

Combat: Five hand to hand attacks per melee. Or can combine psionic attacks (as many as two per melee) with physical attacks, meaning two by psionics plus one hand to hand attack per melee are possible. Each vampire psionic attack is roughly equal to two hand to hand attacks.

Damage: Vampires are considered to have supernatural strength. See the Supernatural Strength Damage Table to determine the damage it inflicts in hand to hand combat. The vampire's killing bite is 2D6 plus P.S. bonus. This damage affects other vampires; this means one vampire can kill another, although their regenerative powers make this difficult.

Bonuses: In addition to attribute bonuses, +3 to save vs horror factor, +2 on initiative, +3 on perception rolls, impervious to all forms of psionic and magic sleeps and paralysis, and +3 to save vs magic or psionic mind control.

Magic Powers: If the secondary vampire knew magic before being reborn into a vampire, he retains about half of that knowledge (player must select the half of the spells remembered). New spells cannot be learned, and the old spells are permanently frozen at their current power levels.

Psionic Powers: See psionic powers. Considered a major psionic: requires a roll of 12 or higher to save versus psionic attacks.

Average Life Span: Presumed to be immortal.

Experience Level: 2nd to 7th level (1D6+1); player characters start at the first level of experience.

Vulnerabilities/Penalties: See the **Vampire Powers Section**.

R.C.C. Skills: The average secondary vampire will retain a total of ten skills. Two additional skills can be selected at levels three, six, nine, eleven, and thirteen. All skills start at first level proficiency and do not increase. The available skill categories are limited to: Communication, Domestic, Piloting, Technical, Rogue, Wilderness and Weapon Proficiencies.

Weapons and Equipment: Secondary vampires prefer to rely on their natural powers and instincts rather than the trappings of technology. At most, a vampire will drive a car or (very rarely) use a gun or other weapon. All vampires derive pleasure and satisfaction when they use their supernatural powers.

Wild Vampires

An Optional Player Character R.C.C.

Wild vampires are created in one of two ways. They have either been driven insane and into their present animalistic state (often from starvation) or created by a secondary vampire. Like the master, secondary vampires can also create new vampires; however, these third generation undead are frequently flawed, one might even say mentally retarded. These misanthropes are incredibly savage and possess the most meager of mental faculties. Most are crazed predators that are more animal than human. They are primal forces that function on instinct rather than forethought. Their lives are consumed with stalking, killing and feeding. They engage in few activities other than tormenting and hurting others. As before, the wild vampires are generally subservient to their vampire creator, the master vampire, and most secondary vampires. ALL wild vampires are subservient to their ultimate creator, the vampire intelligence.

Wild vampires can usually be found in the worst city slums, or in remote wilderness areas, hunting the poor, the unwary, and those who are unlikely to be missed. A few small bands of these creatures can be found roaming the Nightlands, especially the Waste. Wild vampires are hunted down mercilessly by the Nightlord minions.

Alignment: Evil or anarchist, but most are extremely evil (diabolic and miscreant) and radiate supernatural evil. The best alignment possible is anarchist; the wild ones are too savage and aggressive to fight the desire for blood.

Player characters who are wild vampires and not completely evil are still crazed and animalistic. Wild vampires of all alignments are easily provoked, attack when made angry (regardless

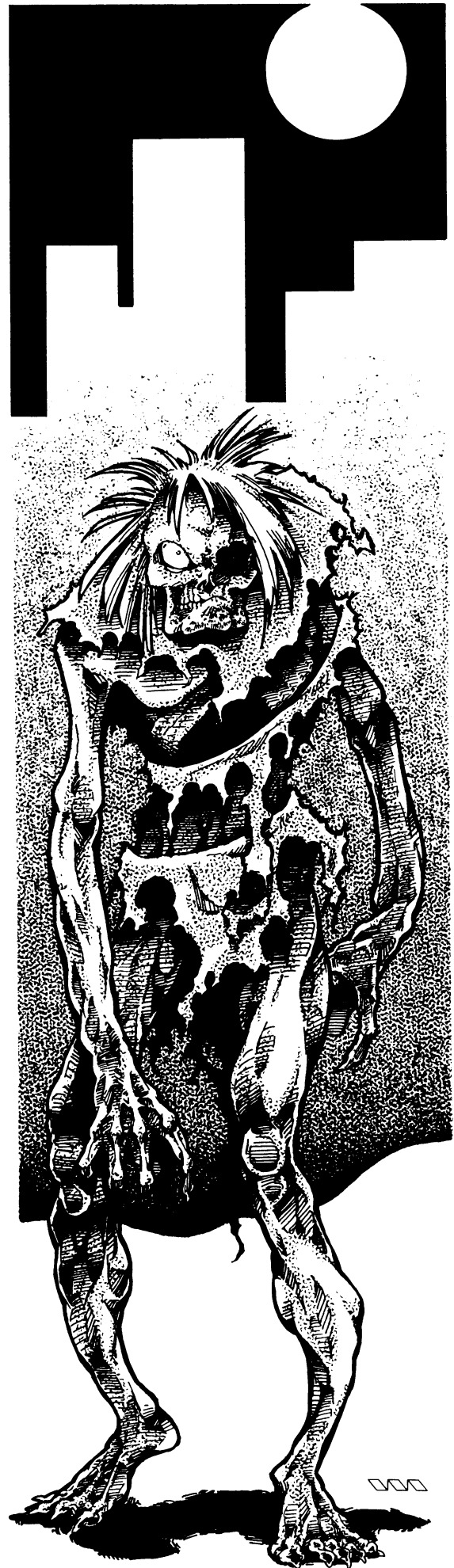

of the consequences), fly into berserker rages and tend to be cruel. Furthermore, they love the taste of human blood and feast regularly.

Attributes: I.Q. 2D6+1, M.E. 3D6+4, M.A. 2D6+2, P.S. 3D6+14, P.P. 3D6+8, P.E. 1D6+16, P.B. 1D6+2, Spd. 5D6+10

Size and Weight: Varies, generally human.

S.D.C./Hit Points: 2D4×10 Hit Points. See Vampire Powers Section.

Horror Factor: 12, **P.P.E.:** 6D6

Natural Abilities: See Vampire Powers Section.

Combat: Five hand to hand attacks per melee. Or can combine psionic attacks (as many as two per melee) with physical attacks.

Damage: Vampires are considered to have supernatural strength. See the Supernatural Strength Damage Table to determine the damage it inflicts in hand to hand combat. The vampire's killing bite is 2D6 plus P.S. bonus. This damage affects other vampires; this means one vampire can kill another, although their regenerative powers make this difficult.

Bonuses: In addition to attribute bonuses, +2 to save vs horror factor, +2 on initiative, impervious to all forms of psionic and magic sleeps and paralysis, and +1 to save vs magic or psionic mind control (this is in addition to possible M.E. bonus).

Magic Powers: None. If any spells were known, they are forgotten during the transformation.

Psionic Powers: See psionic powers description. Considered a minor psionic; requires a roll of 12 or higher to save vs psionic attack. **I.S.P.:** 1D6×10

Average Life Span: Presumed to be immortal.

Experience Level: Average 1-4 (1D4).

Vulnerabilities/Penalties: See the Vampire Powers Section.

R.C.C. Skills: The Wild Vampire retains few of the skills or memories from his former life. Only six skills are retained from the categories below. All skill proficiencies are frozen at second level; no skill bonuses apply. New Skills for player characters: One new secondary skill can be selected at levels two, four, six, eight, eleven and fourteen. All skills start at first level proficiency and do not increase. The available skill categories are limited to: Communication, Domestic, Piloting, Technical, Rogue, Wilderness and Weapon Proficiencies.

Weapons: For the most part, wild vampires lack the patience to use technology and will rather stalk and kill a victim with his bare hands/fangs.

Vampire Powers

All undead vampires (with the exception of the **Wampyr R.C.C.**, described later), possess the same basic powers and abilities.

A Lust for Blood

A vampire should feed on at least two pints (about one liter) of blood once every 48 hours, if not every night. If the vampire is forced (by choice or circumstances) to fast, he starts to suffer the consequences. With each passing night of abstinence, the hunger becomes more powerful.

By the third night, the creature awakens with stomach pains and a craving to feed akin to the desires of a junkie needing a drug fix. The creature can still resist.

On the fourth night, the vampire looks worse than usual; more pale, with a waxy yellow hue to his skin, dark circles surround the eyes, the face and hands are covered in perspiration, and the undead is weak, suffering the following penalties: -2 on initiative, -10% on all skills. Worse, every time he smells human blood within 500 ft (152 m), the vampire must save vs feeding frenzy (treat it as a save vs mind control) with none of his usual bonuses. If the roll fails, the vampire succumbs to his blood lust and runs off to feed. A vampire of good or anarchist alignment will avoid attacking friends or innocents, or if he feeds on them, will try to stop short of completely draining the victim. A second roll (as above) is necessary to stop after two pints of blood have been consumed. If it fails, further rolls are possible after an additional pint has been consumed.

For every day of abstinence after four, the vampire suffers a -1 penalty to save versus feeding frenzy. At this rate, it is only a matter of time before the creature must feed.

Prolonged starvation will lead to insanity. Vampires cannot die from starvation, but forced abstinence will drive the creature insane. After three weeks, the vampire descends into a fully animal state, unable to recognize friends or enemies, think, or perform the simplest tasks. His body becomes more corpse-like with every passing night. Incapable of speech, the vampire can only howl and scream. The moment a victim comes nearby, the vampire will attack on sight, draining and killing the person without a second thought. A few minutes after feeding, the vampire returns to normal, and his body resumes its normal appearance.

If the vampire is kept from feeding for over six months, the vampire will be permanently insane: a master vampire will become a secondary vampire, a secondary will transform into a wild vampire, and wild vampires become even more savage and deranged than usual. The creature becomes driven by instinct even after feeding, and will be unable to function as a normal human under most circumstances. **Note:** Once driven insane by starvation, the vampire is permanently mad and cannot be restored to his former self or social ranking.

The Vampire's Bite

Vampires can choose to create new vampires through their undead bite. This never happens accidentally. People drained of blood and slain do not become vampires. To pass on the curse of Undeath, vampires must deliberately infect their victims through the *Slow Kill*.

Note: Nightbane and Guardians are immune to vampiric transformation and the effects of the slow kill, as are most supernatural creatures (including Doppelgangers, all the servants of the Nightlords, and the Nightlords themselves). However, vampires can feed on the blood of Nightbane, Guardians and Doppelgangers. The Hounds, Hunters and Hollow Men are animated shells with no blood, and the Ashmedai are demonic entities with no links to true living things. Nobody knows if a vampire can feed off a Nightlord or one of his Avatars — mostly because no known vampire has been successful in such attempts.

Slow Kill:

Creating the Undead

The slow Kill is the ability to turn others into the undead. Vampires can turn their victims into vampires by performing a slow kill. To do this, the creature must slowly drain his chosen victim a little bit at a time for three consecutive nights. On the third night, the victim is slain by having all his blood drained. Three days later, the victim rises from the grave to join his demonic creator.

If a master vampire creates a new undead, the result will *always* be a secondary vampire. If a secondary vampire is the creator, roll percentiles: 01-02% means a Wampyr, a half-vampire creature (see new **Wampyr R.C.C.**); 03-44% means a new Secondary Vampire has joined the legions of the undead, and 45-00% means a Wild Vampire has been created. Wild Vampires can only create other wild and deranged undead. Moreover, they usually are too crazed, savage and impatient to bother with the slow kill.

The Passive Victim and Vampire Slaves

The victim of a slow kill becomes passive and subservient, unable to resist the creature during the three days and nights preceding his murder. The victim will be distracted and weak (half skills and attacks per melee), and will wait for his future master to appear the next two nights to finish the job. The vampire can call the victim from a range of 100 feet (30.5 m), and give mental commands like “come to me,” “open the door” and “remove the crucifix.” Also, the vampire will be able to sense the location of his victim up to 400 miles (640 km) away!

Vampires can also create human slaves through a series of non-lethal bites, a process similar to the slow kill. This slave is beholden to the vampire and will obey and never betray his master. A secondary vampire can only create one such servant; master vampires are limited to two such slaves.

Mind Control:

Vampire over Vampire

Vampires are in effect, an extended family linked by the shared essence of the vampire intelligence. Through this family link, vampires can sense others of their kind, and automatically know if a given vampire belongs to the same essence/creator. They can also sense whether their brother vampire is a master, secondary or wild vampire. Vampires who are extensions of other intelligences are also recognized, but are seen as potential rivals and enemies.

This self same link also allows vampires to try to exert control over others. The Undead community has a hierarchy of masters and servants. A vampire will sometimes only acknowledge a leader after it has asserted dominance over him through mind control. This mind control power is automatic and costs no I.S.P. When mind control is attempted, the attacking vampire’s eyes glow bright and his voice sounds like thunder. The target of the mind control must roll to save versus psionic attack or fall prey to the power of the superior vampire. This control, once achieved, is total, lasting 2D6 hours.

The older/more powerful a vampire is, the harder it is to defy him. Penalties range from -10 (for a vampire intelligence trying to command wild vampires) to -1 (an older vampire trying to command another).

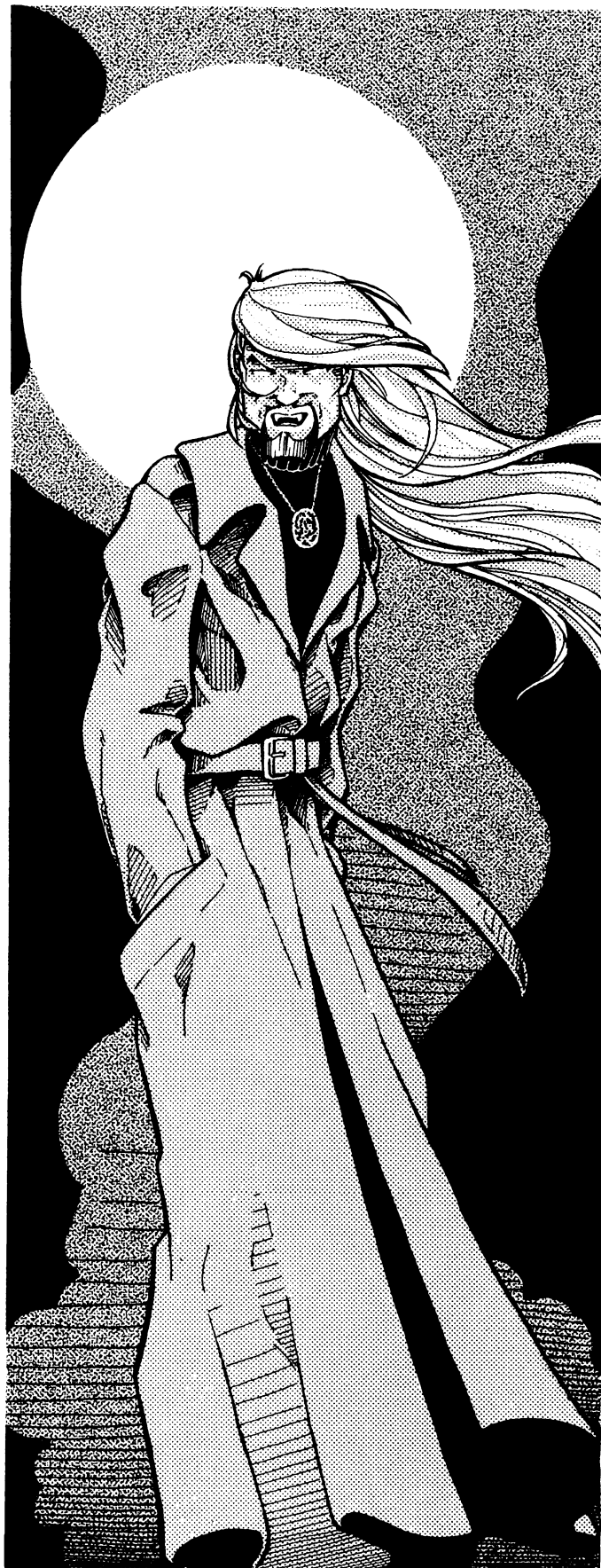

Psionic Powers of the Vampire

In addition to the various mind control powers previously detailed, all true vampires also possess a handful of more traditional psionic powers. I.S.P. is required to use these powers.

Powers: All are equal to a fourth level psionic.

Death Trance	Presence Sense
Alter Aura (Self)	Sense Evil
Empathy	Deaden Pain
Mind Block	Induce Sleep
Hypnotic Suggestion	
Super-Hypnotic Suggestion (NEW, exclusive to vampires).	

Super-Hypnotic Suggestion (special)

Range: Line of sight; must look victim directly in the eyes (the vampire's eyes glow red or yellow when this power is used).

Duration: Five minutes per level of experience (20 minutes for the average vampire), or until the vampire is killed or willingly releases the victim.

I.S.P.: 20

Saving Throw: Standard

This mind control power enables the vampire to place any living creature in a light trance and enforce his will over the victim's. The vampire's commands will be obeyed except where they would go completely against the victim's alignment. By cunningly using this power, the vampire can phrase a command in a way that the victim will have no compunction to refuse.

Telepathic Link with Minions (special)

This automatic power links a master vampire to its creations, enabling the creature to sense the presence of the minions at a range of 10 miles (16 km), or feel when one of its creations is hurt or killed, or to summon all of the minions within a 100 mile (160 km) area. In turn, the minions can tell whether the summons is a general call to gather or whether they should come with haste because the master is in danger. The minions will also sense when the master has been slain.

Metamorphosis

Vampires can transform into a large bat, wolf, or mist. The transformation takes about seven seconds to complete, or about the equivalent of one melee attack/action. While in non-human form, the vampire retains his intelligence and identity, but cannot speak, perform skills or, in mist form, use psionic powers. The vampire's clothing and other small, personal articles disappear during the transformation and reappear once human form is assumed once again.

Vampire Bat Abilities

Fly: Speed of 50 (35 mph/56 km)

Other Natural Abilities:

Sonar/echolocation: Enables the vampire to fly in total darkness at full speed and see the invisible.

Ultrasonic Hearing: Hears high and low frequencies; very acute. Can hear a moth's wings beating but cannot understand the spoken word (too slow).

Thermo-imaging Sight: Close range, 10 ft/3.0 m; for sensing and seeing the heat emanations of warm blood coursing through the veins. But cannot see infrared light.

Combat: +2 to strike, +3 to dodge, +8 to dodge in flight, +5% on prowl ability.

Attacks per melee: Half normal, bite inflicts 2D6 S.D.C. damage, claws 1D6 plus P.S. damage bonus. Can inflict vampire slow kill bite and drink blood while in bat form.

Wolf Abilities

Run: Speed of 58 (40 mph/64 km)

Other Natural Abilities: Track by scent 70% and leap 20 feet across (6.1 m) and about 6 feet (1.8 m) high.

Combat: +2 to strike, +1 to parry, +4 to dodge, +1 on initiative, +15% on prowl ability.

Attacks per melee: Add one to the normal humanoid number of attacks. Bite 5D6 damage (no P.S. bonus).

Mist Abilities

Speed: 11 (7.5 mph/12 km)

Other Natural Abilities: Impervious to all physical attacks, including wood, silver, fire and most magic. Still vulnerable to water and elemental magic. Can slide under doors, through cracks and crevices, keyholes, etc.

Combat: None. Cannot attack in mist form; all it can do is move/flee. +10% to prowl ability (although silent, the mist is very large and obvious).

Note: Cannot use psionics in mist form, but can use them in animal form.

Summoning Powers

The vampire can summon various vermin, canines, and (at 7th level) fog. The vermin includes rats, mice, flies, gnats, cockroaches and other disgusting critters. Large vermin (rats) have a H.F. of 9 and can bite, inflicting 1D6+1 points of damage per melee round to unprotected victims. Smaller vermin have an H.F. of 6 and are extremely distracting, annoying and intimidating (victims lose one melee attack, -4 on initiative, -1 to strike, -2 to parry and dodge). The vampire can summon 100 large vermin or up to 500 small vermin per level of experience.

Canines (dogs or wolves) can be summoned at the rate of six per level of experience. The pack of canines has an H.F. of 8. Typical canines will have two or three attacks per melee and inflict 1D6 damage from a bite.

Fog can be summoned by 7th level or higher vampires. The fog can cover an area of up to a mile (1.6 km), and reduces clear visibility to four feet (1.2 m). Blurred shapes and shadowy figures are all that can be seen for an additional 10 ft (3.0 m).

Duration: Any of these summonings lasts 20 minutes per level of experience.

Limited Invulnerability and Super Regeneration

Vampires are immune to most normal weapons; metal blades, bullets, fire, electricity, lasers or explosives will do absolutely no damage. A large explosion may knock a vampire down, and repeated sword strokes may shred the creature's clothing, but the undead's flesh will remain whole and untouched. Wooden weapons (clubs, stakes, fire-hardened spears without metal or stone heads) *WILL* harm a vampire, inflicting damage directly to hit points. So will silver bullets or silver-plated weapons. Magic

The stake is removed.

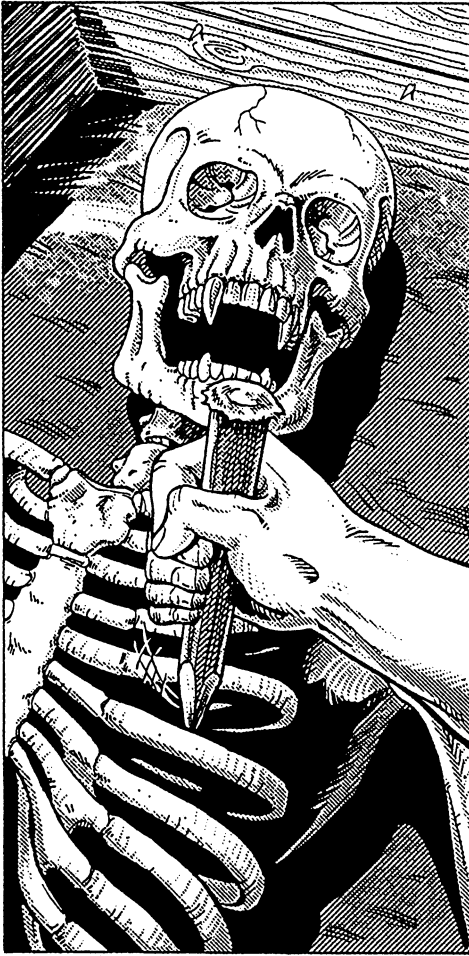

Mist streams from the remains.



Bone and tissue reform.

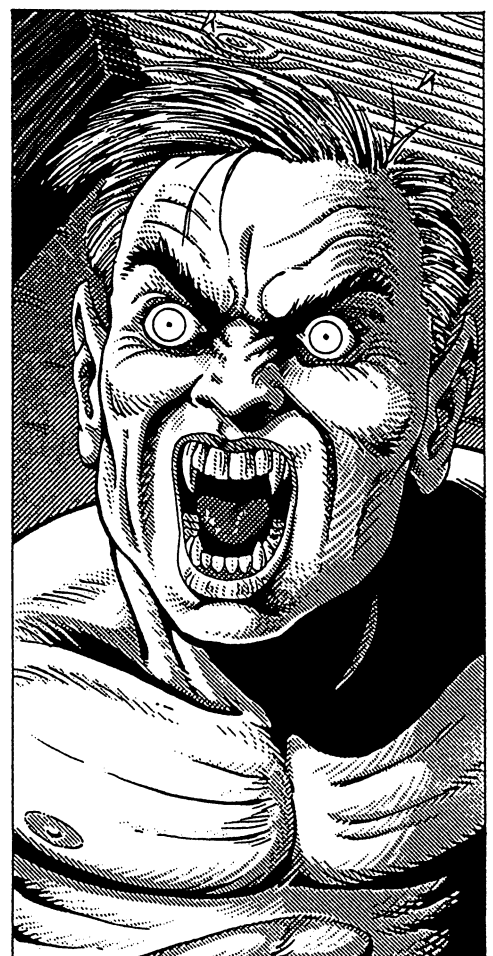
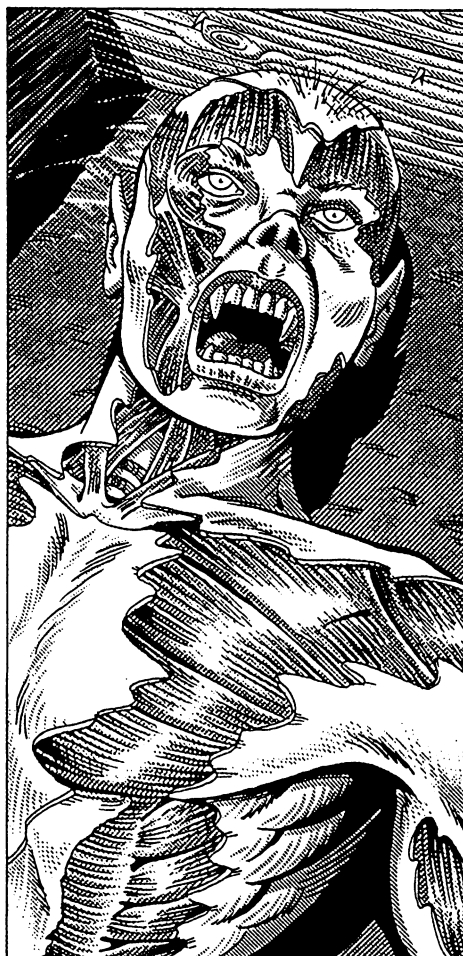
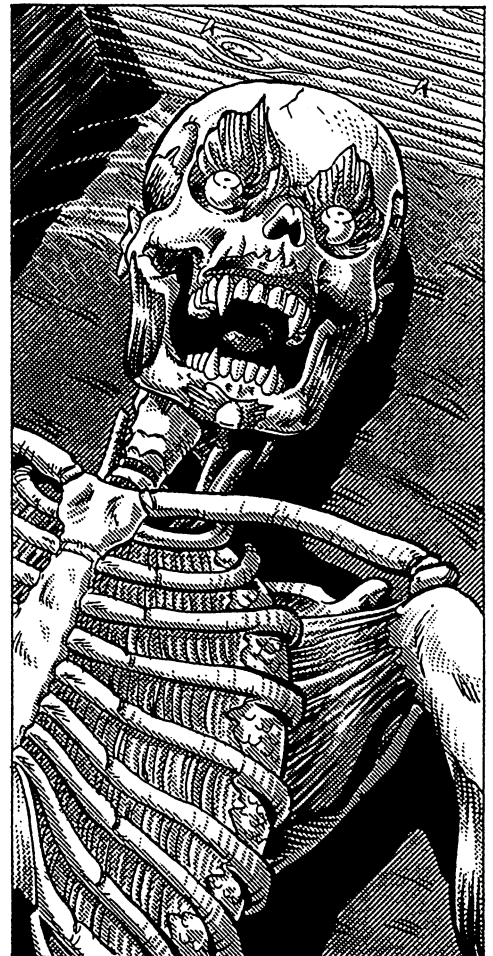

LOVE / STEMBEDA - 1991

The transformation from skeletal remains to living vampire. The entire super-regeneration takes less than 15 seconds. The vampire is restored.

spells and charmed weapons will also inflict damage, but spell magic does only *half* damage. **Note:** The attacks of supernatural beings like Nightbane and Guardians will do direct and full damage to the vampire's hit points.

All these attacks, however, will not truly kill the vampire. The creature regenerates damage at the rate of 2D6 points per melee round. Furthermore, vampires can fight and function until reduced to 20 points below zero! At -21 points, the creature drops to the ground and appears to be dead, but instead, it is in a powerful healing trance. Unless specific measures are taken, the vampire will be completely healed in a matter of minutes.

A **stake through the heart** will appear to destroy the vampire. The vampire will collapse to the ground and the body may shrivel to look like an ancient corpse or skeleton. In reality, however, the vampire is in a state of suspended animation, and removing the stake will result in the vampire coming back to life in a matter of seconds.

To Kill the Vampire

Only four methods are guaranteed to kill the vampire.

1. Death By Ritual Disposal: The vampire must be immobilized by driving a wooden or silver stake, or spear other point through its heart, rendering it helpless. Then its head must be removed, and the head and body must be burned in separate funeral pyres, and the ashes scattered. While normally invulnerable to fire, vampires can burn after being staked or impaled by wood.

2. Death By Sunlight: Sunlight will turn a vampire into ashes. Every melee round (15 seconds) of exposure will inflict 1D6×10 points of damage directly to hit points. The vampires are powerless in the light of day, unable to use their powers and barely able to move (reduce all attacks and speed by one-third). In a manner of minutes, they are permanently destroyed. The spell Globe of Daylight is not powerful enough to destroy a vampire, but will keep them at bay. The light created by the Guardians will inflict 5D6 points of damage per melee round, but vampires suffer no penalties other than the damage inflicted (can flee or attack at will).

3. Death by Water: Running water can also destroy a vampire. From a water gun to rainfall, water cleanses the vampire and melts its body away! Immersing a vampire in a body of still water (a lake, swimming pool) will inflict 6D6 points of damage each melee round. A toy water pistol will inflict 2D6 damage per squirt. This damage can be healed, but takes more time (vampires regenerate from water damage at the rate of 6D6 points every minute). If reduced to -21 points, the vampire melts into oblivion.

Vampires also cannot cross over running water unless a bridge is available, and even then they must save versus Horror Factor 16 to do so. Typically, vampires cross bodies of water only when transported in sealed containers by trusted servants.

4. Soil of the Homeland: This vulnerability can also lead to the death of a vampire. Vampires must sleep on the soil of the land in which the vampire was originally turned into an undead. This "homeland" covers the entire continent, so if a vampire was created in North America, he can sleep anywhere in the conti-

ental U.S., Canada and Northern Mexico. Without his native soil, the vampire cannot sleep; if a new amount of soil cannot be found, the vampire must remain on the surface during the next day, doomed to be destroyed by the sun.



Means of Defense

Crosses: These are non-lethal means of protection against vampires. The symbol and even the shadow of a crucifix (T-shaped cross) will cause the vampire to recoil in apparent fear and pain. A cross held firmly in hand can be used to force a vampire away. Wearing it around the neck protects one from the vampire's bite. The shadow or the physical touch of a cross will inflict such pain that the vampire must roll versus horror factor 18. A failed roll means the fiend is temporarily paralyzed by agony for one full melee. The touch of a crucifix will inflict 2D6 points of damage. The shadow of a large crucifix, if it covers over half or more of the vampire, inflicts 1D4×10 hit points. Unfortunately, the vampire's regenerative powers prevent any permanent damage.

Herbs of Protection: Two herbs can be used to ward off the undead. They are garlic and wolfbay. Hanging either on a door, or around a window, and above a fireplace will prevent a vampire from entering one's home. Waving the herb in the face of the undead will cause them to recoil. Nor will the vampire enter a circle made of either herb. Eating large portions of the herb will cause the monster to retch and vomit blood.



The Wampyr R.C.C.

Optional Player Character

It wasn't sensual or seductive, or any of those things people like to think vampires experience. It was a violation, pure and simple. It was being overpowered, controlled, knowing you were not in control, and probably would never be again.

He came to me in the night. At first I thought he was just one more John, willing to pay his twenty bucks and get his jollies on my skinny bod. I don't remember exactly what happened next. He said I would be his "huntress." Then for three nights I was at his beck and call, his slave. And then he killed me.

Something changed afterwards. Maybe it had been my three years in the streets. Maybe it was what happened to me at home that made me want to live in the streets. But when he tried to tell me what to do, it didn't work. He was so surprised he barely struggled when I rammed a piece of chair through his chest. Then I put him in the shower and watched him run down the drain. For some reason, the running water didn't hurt me at all. Sunlight hurts me, but I can go out during the daytime when I have to. I always liked to work nights, though.

Now I'm still a street walker, but I have a different job. I'm looking for others like the guy who changed me.

I want to see them all run down the drain.

Wampyrs (pronounced vom-peers) are a strange breed of vampires. Like normal or true vampires, they were hunted and then converted by the "slow kill," but something in these "victims" is different. Some occultists speculate that maybe they are

true innocents or have pure souls. Perhaps the soul has nothing to do with it; some people may just be too strong-willed for the vampiric domination and transformation to take hold. A third possible explanation might be that Wampyrs were *latent* Nightbane whose supernatural origins rendered them partially immune to vampirism. Nobody, including vampire intelligences, knows the truth.

In many ways, Wampyrs are still inhuman creatures. They need blood to survive. Light hurts them and will kill them over time. Unlike true vampires, however, they are free to choose the path of their lives. Although leading a normal life is nearly impossible, they can try, and many do. Many have tried to keep their natures a secret from their family and loved ones, and control their urges. Others have become criminals or predators, just as dangerous as the traditional vampires. Several Wampyrs have actually declared war against their blood sucking cousins and other evil entities. One such Wampyr is the mysterious *Iosef Pendragon*, the founder of the Nocturnes (see the *Nightbane Factions Section*). Some have even allied themselves with Nightbane, human sorcerers and even rebellious secondary vampires!

Wampyrs have several advantages and disadvantages when compared to other vampires. Unlike traditional vampires, they can be killed by conventional attacks, including guns and knives. Their healing factor is just as powerful, but when reduced below zero points, they are as much in risk of dying as a normal human. And they lack some of the vampire abilities, such as turning into mist or shape-shifting into a bat or wolf.

On the plus side, sunlight harms Wampyrs much more slowly, enabling them to survive for hours of exposure, although it is still a very painful and incapacitating experience. Typical anti-vampire measures, including running water, holy symbols, herbs and the need to sleep on native soil do not work against Wampyrs. Staking a Wampyr will inflict a great deal of damage, but will not incapacitate him. And, although Wampyrs need to drink blood to survive, they need far less than the true undead. An evil Wampyr can be extremely dangerous to a group of vampire hunters who are prepared to fight this mutant breed — the hunters will quickly discover that much of their equipment is useless against the creature.

Vampire intelligences and master vampires hate and fear Wampyrs and attack them on sight without ever giving or asking for quarter. They are considered to be aberrations and a terrible danger for the entire undead species. Among other things, all Wampyrs instinctively know all the strengths and weaknesses of true vampires, even those that do not affect them. This makes them incredibly effective vampire hunters.

Alignment: Any except principled. Scrupulous vampires will avoid drinking the blood of unwilling people. Available as a player character.

Attributes: I.Q. 3D6+1, M.E. 1D6+14, M.A. 3D6+6, P.S. 3D6+12, P.P. 3D6+6, P.E. 3D6+8, P.B. 3D6+3, Spd. 3D6+6

Size and Weight: As a normal human.

S.D.C.: 2D6×10+20 plus those gained before the transformation from physical skills and O.C.C.s.

Hit Points: P.E.x2 plus 1D6 per level of experience.

Horror Factor: 11

P.P.E.: 1D4+2; most P.P.E. is permanently lost during the transformation.

The Guardians

Natural Abilities: Wampyrs share the vampire's super-regeneration powers and heal 2D6 S.D.C./hit points every melee round. They have supernatural strength and endurance, and have a number of psychic powers (see below). Wampyrs take half damage from metal weapons, but have none of the normal vampire invulnerabilities.

Vulnerabilities: Blood Dependency: Wampyrs must drink one pint (about half a liter) of blood every three days (72 hours). Going on without blood will result in the feeding frenzy (see *Vampire Powers Section*), but the effects do not start until the first week, and it takes three days to aggravate the frenzy state.

Vulnerability to Sunlight: Wampyrs exposed to direct sunlight will take 2D6 points of damage for every minute (4 melees) of exposure. Getting into a shadowed area allows their regeneration power to "kick in" and heal this damage. So, by dashing in and out of the shade, a Wampyr can operate in the sunlight. However, this is very painful and incapacitating. Those suffering from sun exposure lose one attack per melee round, are -1 on all combat rolls, -2 on initiative and perception rolls, and -20% on all skill performance while exposed to sunlight. These penalties also apply even operating during the day when in the shade or even underground.

Psionic Powers: Start with all the vampire psionic powers except super hypnotic suggestion. Can select one additional power from any of the three psychic categories every level after the first.

Magic Powers: None. Wampyrs are unable to work magic. If the character had any magic powers before being turned into an undead, they are lost forever.

I.S.P.: M.E. plus 2D4×10. Add 8 points per level of experience.

Combat: As per hand to hand skill.

Damage: Supernatural strength.

Bonuses: +1 on initiative, +3 on all perception rolls, +5 to save vs horror factor, +5 to save versus all forms of mind control and possession, and is immune to vampire mind control powers.

Average Life Span: Unknown, possibly limitless.

Experience Level: Varies.

R.C.C. Skills: Select 10 skills and 8 secondary skills, plus select an additional skill at levels four, seven, ten and twelve. Unlike true vampires, Wampyrs do not lose touch with their past life. Skills should be selected to conform with the character's occupation/education before the transformation.

Alliances and Allies: Wampyrs often work with human vampire hunters and other enemies of the vampires. Some Wampyrs may actually become minions of the Nightlords just to have the chance to destroy them or their undead cousins (Nightlords use Wampyrs to hunt and slay true vampires), however, only evil or anarchist characters would consider such a thing. Wampyrs of a good or anarchist alignment are frequently, although warily, accepted into groups of humans and Nightbane. Guardians find the creatures disturbing and tend to avoid direct contact with them, but they do not destroy them on sight like they do true vampires; some have even let Wampyrs join their group to combat the forces of evil (must be a good alignment).

Weapons and Equipment: Varies with situation and occupation.

Money: Typically, start with 2D4×100 in cash and 2D6×1,000 dollars in property (includes vehicles and equipment).

A Mysterious Force

Outcasts serving a higher power, or puppets of an alien force? Not even the Guardians fully understand who or what they are. With a few exceptions, most Guardians appear to be men and women who were transformed into supernatural beings, but who lost their memories in the process. For the most part, the transformation appears to be voluntary, because, despite their fading memories of their past and their uncertain future, most Guardians share a resolve to help and protect humankind wherever they go.

Their good intentions are backed up by incredible power. They can heal and destroy with equal ease, and are the bane of all evil supernatural beings. The Guardians are not omnipotent, however. The fact that they barely remember their pasts reduces the number of useful, everyday and professional skills they once might have had. They often have to rely on human friends or followers, or on the charity of strangers. Although their psychic powers help them see into the souls of people, their judgment is not infallible, and they sometimes hurt those they wish to help. A few Guardians are naive and can be fooled by carefully-contrived lies. Others become self-righteous and intolerant of those who do not meet their standards.

Most Guardians try to use their powers carefully and with moderation. They instinctively know that glory and power corrupts, and prefer to work in subtle ways. If possible they avoid claiming any credit for their deeds, and the only times when they reveal their full powers is when coming face to face with pure evil, be it in the actions of humans or supernatural beings. They are often allied with human psychics and (more often) normal men and women who share their vision. Less frequently, they will associate with supernaturals who are also dedicated to helping humankind. Several *Nightbane*, and even the odd Wampyr or Doppelganger, have joined forces with either an independent group of Guardians or the Lightbringers organization.

The Guardian R.C.C.

— Optional Player Characters

The Guardians appear to be normal humans, although they tend to be about a head shorter than average 20th Century people (average height is five feet/1.5 m). At first glance, they can easily be confused for albinos, for they have sheet-white skin, their hair is nearly white and their eyes are almost transparent gray, green or blue. Although it is possible to disguise the Guardian's strange appearance, the Guardians, unlike *Nightbane*, are always trapped in an alien shape and are always risking exposure. And, like *Nightbane*, the Guardians are often attacked by those they wish to help. Many try to disguise themselves by wearing wigs or hair dyes, make-up and colored contact lenses. Their skin is always smooth and free of wrinkles or blemishes, and without much in the way of facial and body hair. This makes the Guardians appear child-like and a lot younger than they really are. Sometimes, Guardians disguise themselves as children or



teenagers, and sometimes they transform into Guardians when they are children or young adults. The Nightbane talent of *see truth* will reveal a powerful aura of invisible light surrounding them.

Belying their child-like appearance, Guardians are incredibly strong and resilient. They can heal themselves (and others) at an amazing rate and have powerful psychic abilities. Their flashiest and most impressive abilities involve the use of light as a weapon. The Guardians can create light, from bright sunlight in the middle of the night to concentrated blasts of pure energy, that does enormous damage to supernatural beings, as well as shields of light that can stop bullets. They are not invulnerable, however, and can be killed by conventional, magic, psionic, or supernatural means.

Although Guardians will kill if necessary, they will almost always seek a non-lethal way to resolve a situation. Humans are only killed if the lives of innocents are at stake, or the person is truly evil or a willing pawn of evil forces. Evil supernatural beings, including diabolic Nightbane, minions of the Nightlords, and true vampires, are destroyed out of hand, but those who show signs of redemption or good intentions will rarely be killed or bothered, except by the most intolerant of Guardians.

Guardians as Player Characters: Allowing Guardian player characters in a **Nightbane** campaign presents some different challenges and opportunities to Game Masters. First of all, Guardian player characters should remember even less about their true origins than Nightbane. Secondly, this book does not

answer most questions about the Guardians: Where do they come from? Who or what created them? What are their creators' goals? Are they champions of a higher power, or pawns in a more complex game? Can they be corrupted by evil? Future **Nightbane** supplements may give further hints and eventually, even fully answer these questions. In the meanwhile, Game Masters have to come up with their own tentative answers and explore the possibilities.

At first glance, playing a Guardian sounds cool — basically, a supernatural superhero to pound on the evil monsters. It's not that simple, however. Guardians are as strange and scary in their own way as Nightbane. To some people, they may appear to be "angels," to others extraterrestrial beings, or even gods, and they will react with awe, respect, or adoration, but others (even good folk with nothing to fear) may react in terror or panic. Even positive feelings can result in Guardians being mobbed and beset by fanatical would-be followers seeking guidance or help. An awkward situation, especially for the young Guardian who will have precious little wisdom to teach and who will feel overwhelmed by the demands made upon him! The poor creature may even be hated and attacked by frightened or disillusioned people who believe that god is unjustly punishing them or has abandoned them, so they strike at the Guardians who they believe are god's messengers. Not knowing what he is, the character will be unable to defend himself with words and may be powerless to soothe their sorrow, despair or pain.

The Guardian R.C.C. is something of an "anomaly" in a dark, contemporary horror RPG. In a genre dominated by character

types who are reluctant heroes at best and outright villains at worst, the Guardians represent a throwback to an older time, when heroes were willing and even eager to help those around them. For those who claim such characters are “unrealistic,” a look at today’s social workers, volunteers, and everyday heroes who spend time, effort and even risk everything to help others is recommended. Guardians are *not* god-like problem-solvers; they are often guilty of lapses in judgment, and their attempts to help sometimes go awry. The one constant among them is that they *want to help others*, selflessly and with dedication. The author hopes that some players will not find such a character an impossible role-playing stretch.

Natural Abilities:

1. Precognitive Senses: Guardians are able to perceive the world in ways beyond the abilities of mortals. Their most impressive ability is their precognitive sense, which acts on an instinctive level to lead them to places where their help might be needed. The information is rarely clear or definite; usually, it is a “gut feeling” that the Guardian(s) should go to a city, neighborhood, or even a particular establishment because they are needed. For example, a group of Guardians would get the feeling they’d be needed, and “see” short flashes of a low-class bar by the docks. The Guardians get there just in time to witness (and stop?) the attempted murder of a journalist or Nightbane at the hands of Hounds or other supernatural beings.

The precognitive sense is not reliable or accurate, however (**G.M.’s Note:** This sense should not be overused; it can help guide the player characters in the course of an adventure, but if overdone, the player characters will feel like they are being spoon-fed the game’s plot or forced into actions they might not have chosen themselves. Precognitive sense is best used at the beginning of an adventure, to get things started and/or in little flashes, such as sensing that a person needs help or that something is not right despite appearances to the contrary.)

2. Supernatural Senses: Guardians have perfect Nightvision (able to see in complete darkness) with a range of 500 feet (152 m), they can see into all spectrums of light, including infrared and ultraviolet, and can see perfectly in light that would be blinding to others. They can also see the invisible and recognize illusions with a successful perception roll (10 or higher).

3. Super-Regeneration/Healing Touch: By spending P.P.E., Guardians can heal wounds at an amazing rate. This power can be used once per melee round on itself or on others. The amount of damage that can be healed is limited to the creature’s P.E. attribute and the expenditure of P.P.E. Each damage point restored costs one P.P.E. point. The maximum that can be healed with any single touch is equal to the character’s P.E. attribute, so a Guardian with a P.E. of 20 can heal 20 hit points or S.D.C. worth of damage. Activating this power counts as two melee actions/attacks, and it can only be done once every minute (4 melee rounds). The Healing Touch causes the Guardian and his patient to be surrounded by an aura of light that flares until the healing is done. **Note:** Even without this ability, Guardians still heal much faster than humans, healing 2D6 points of damage every hour.

4. Powers of Light: The ability to create light energy blasts or shields. The energy bolts inflict 1D6 S.D.C. for every P.P.E. spent and they are +3 to strike.

The shields of light afford 5 S.D.C. of protection per P.P.E. spent, and last for one minute (4 melee rounds) per level of experience. Additionally, Guardians can produce light from their bodies, illuminating an area as if it was bright sunlight at no P.P.E. cost. This light actually harms vampires and other entities who cannot stand sunlight, but only half as effectively as true sunlight.

5. Nullify Magic: Using their powers of light, Guardians can counteract or nullify most spells. Like most Guardian powers, this effect manifests as a flash of bright light. P.P.E. must be spent by the Guardian and must exceed the P.P.E. spent in the spell. The Guardian can sense if a spell is being cast or a spell effect is still affecting something in his presence. Instantaneous or permanent effects can only be nullified if the Guardian uses his power as the spell is being cast (each attempt to nullify magic counts as one melee attack/action). Since the Guardian cannot know what spell is being used, he must decide how much P.P.E. to spend; risking a lot may not be enough, or far too much. **Example:** A Priest of Night casts a Carpet of Adhesion spell (10 P.P.E.) on a Guardian. The Guardian knows a spell is being cast, and decides to use 20 P.P.E. to nullify the spell. Since the P.P.E. spent by the Guardian is far more than the spell’s cost, the spell fails and no carpet appears. Both the Guardian and the priest have used up one melee action and the P.P.E. required for that action.

6. The ability to Hover or Fly: These creatures of light can hover or levitate (float up and down) by expending 2 P.P.E. points. The power to hover or levitate lasts for two minutes per level of experience.

They can also fly by expending 6 P.P.E. points. The ability to fly lasts for two minutes per level of experience. Maximum speed is 40 mph (64.3 km) and maximum altitude is 2000 feet (610 m).

7. Others: The Guardians do not need to eat, drink water or breathe air! They are effectively solar powered and feed on light energy. Thus, as long as they are exposed to a few hours of sunlight every day, they stay healthy and strong. Being deprived of light will weaken and hurt (but not kill) a Guardian. After two days without light (even overcast days provide enough light to satisfy the creatures, so they must be locked away), the Guardian begins to weaken. Every day without sunlight, the character loses 20 S.D.C. (then hit points go down to 10). Furthermore, after seven days the Guardian’s attributes, powers, attacks per melee and bonuses are reduced to half, and after 14 days they are reduced to one! The character can linger in this feeble state for decades without dying. One day (24 hours) of exposure to sunlight is needed to recover for every decade of deprivation. They recover to full strength in a matter of six hours of exposure to sunlight for any time less than a year. **Note:** Being in the Nightlands is the same as light deprivation and will have the same debilitating effects. Thus, Guardians must come and go from this place to function well.

Alignment: Almost always principled or scrupulous. Evil Guardians exist, but they are a tiny minority who usually become lost or perverted after their transformation. Other Guardians will sense the presence of an evil Guardian and will do everything in their power to destroy or capture him.



Attributes: I.Q. 2D4+16, M.E. 2D6+16, M.A. 2D6+12, P.S. 2D4+14, P.P. 2D4+16, P.E. 2D6+14, P.B. 1D6+14, Spd. 2D6+20 running.

Note: Attributes tend to remain fairly constant among the Guardians, with relatively small variations between individuals. It is believed this might mean the Guardians' bodies are created, not grown, to fulfill their purpose.

Size: 5 feet (1.5 m) on the average.

S.D.C.: 2D6×10 +100 plus skill bonuses.

Hit Points: P.E.x2 plus 2D6 per level of experience.

Horror Factor: 9 when their alien features are not hidden, 12 when they display their energy powers. As often as not, this Horror Factor is actually awe or adoration.

P.P.E.: P.E.x5 plus 20 per level.

Combat: Varies with skill selected. Typically Hand to Hand: Basic.

Damage: Use the supernatural strength table to determine hand to hand damage.

Bonuses: +1 on initiative, +3 on all perception rolls, +1 to dodge, +2 to roll with fall or impact, +4 to pull punch, +4 save vs magic, +3 to save vs psionics, +5 to save vs horror factor.

Magic Powers: None. Guardians are unable to learn and manipulate magic, but have the ability to nullify magic and possess mystical powers as described in the Natural Abilities, above.

Psionic Powers: Guardians start with the following psionic powers: empathy, mind block, presence sense and see aura. Every level after the first, they can select one power from the sensitive or healing categories. Considered to be master psionics.

I.S.P.: M.E. attribute plus 1D6×10 I.S.P. Add 10 points per level of experience.

Average Life Span: About four times as long as normal humans'; believed to be 300 to 400 years.

Experience Level: Varies. Typical Guardian player characters begin at first to second level. Experienced NPCs can be of any level, and Elder Guardians have an average level of 1D6+6.

R.C.C. Skills: Guardians are for the most part, normal humans who were granted supernatural powers, but which caused them to lose most of their memories in the process. As a result, they only have a few skills, most of them simple, non-technological skills. Select 10 skills from the list below, plus 8 secondary skills. Add one additional skill at levels three, six, nine and twelve. All new skills start at the base skill level.

Communications: basic radio only.

Domestic: Any (+10%)

Electrical: None

Espionage: None

Mechanical: None

Medical: First aid, holistic medicine and paramedic only (+10%)

Military: None

Physical: Any

Pilot: Automobile, motorcycle and horse riding only (+5%).

Pilot Related: None

Rogue: None

Science: None

Technical: Any (+5%)

W.P.: Any

Wilderness: Any (+5%)

Alliances and Allies: Guardians often work with normal humans, many of whom believe Guardians are angels or benevolent extraterrestrials. They also work with practitioners of magic, psychics, and Nightbane who prove themselves to be dedicated enemies of the Ba'al.

Weapons and Equipment: Rarely use weapons. Most Guardians dislike guns and prefer to rely on their natural abilities.

Money: Guardians usually start out their new lives with the clothes they were wearing and little else. Might have 2D4×10 dollars to start. As they make allies and are helped by other Guardians, funds can be increased to 2D6×100 dollars (which is usually spent on necessities and helping others).

Regular Hangouts/Bases of Operations: Most Guardians can be found near soup kitchens, churches, temples, the biggest cities and the worst slums of cities. They may also have a retreat/sanctuary/a place to heal and meditate in the wilderness or on a mountain top.

Campaigns & Adventures

“Go, go, go, go!” I yelled and jumped out of the van. Three human guards hadn’t been fooled by the smoke bombs the second team had thrown through the windows at the other side of the house. They were reaching for their guns when I mowed them down with a long burst from my Uzi. Even as I was reaching for a new magazine, Burger-face ran past me, swinging his energy whip and laughing like a madman. The rest of the team spread out. “She’s close,” Burger-face growled, his horrible features working hard at producing a grin. “I can smell her.”

“Which way?”

Instead of answering, Burger-face rushed through the double doors leading to the office. This was the place that Janice Hotchkiss had been using as her headquarters. From it, she had been waging a street war manipulating and murdering human and Nightbane alike throughout the state. “Payback time!” Burger-face howled as he leaped forward. I rushed in after him, trying to get a clear shot.

Burger-face bounced against a wall, thrown away with incredible force. The brick and concrete crumbled under the impact. Janice Hotchkiss stood by her desk, laughing. I took aim. Still laughing, she gestured, and the gun liquefied in my hands. Molten metal burned me to the bone, faster than I could heal.

“Little children,” she said. Her smile was full of fangs. “You shouldn’t have annoyed me.”

While a great deal of adventures and campaigns are possible in the **Nightbane** setting, some obvious or basic ideas or themes suggest themselves. The Game Master might want to think about the type of campaign and atmosphere he wants to run, if only to have an idea of what events or situations to create for the first few game sessions. Eventually, the player characters’ actions may change the focus and theme of the campaign, or even take it in completely unexpected directions.

Outlined below are suggestions and ideas for *some* possible Nightbane campaigns, the types of characters and encounters possible, and some suggested plot lines, allies and antagonists.

From the Beginning

This is perhaps, the best campaign to start a Nightbane game. The game begins in the days before Dark Day. The player characters are normal people, most of them in their late teens/early twenties — until the sun goes out and they discover their terrible secret. The characters get to endure the chaos and horror of Dark Day, complete with riots, fires, monsters, and mass hysteria. Then they can be approached by older Nightbane who let them know about such things as the Nightlands, the Ba’al, and the dangers facing them.

The biggest advantage of starting a campaign on Dark Day is that the players can be introduced, along with their characters, to the **Nightbane** universe just as events unfold. The characters might or might not know each other beforehand (all or some of

the player characters may have all been going to the same high school or worked for the same business, or might be from/in the same orphanage, etc.). A lot of the events described in this book (the creation of the NSB, the rise of the Preserver Party) are still months or years in the future, as are most of the newer Nightbane factions. The player characters might be there to witness the splintering of the Underground Railroad and the creation of the Resistance Faction. If the characters are heroic enough, they might be able to slow down or even prevent some of the Nightlords’ accomplishments. **G.M.’s Note:** Since players in such a campaign might use some of the information in the book to their unfair advantage, feel free to *alter* some or all “future” events in a “Dark Day” campaign setting.

A Couple of Plot Lines:

1. The player characters are city high schoolers who endure the Becoming in front of witnesses. Former friends and loved ones turn away from them in horror, and a lynch mob or the authorities (perhaps minions) may pursue them. Do the characters fight their neighbors and family, or do they try to flee? The



player characters could be saved by an old Nightbane from the Underground Railroad, or they could spend most of Dark Day traveling through the nightmarish landscape of a city in chaos, becoming outcasts in their own world. Play their coming to grips with their inhuman side, and their discovery and reactions to the evil supernatural forces at work.

2. These Nightbane are fortunate enough to live in a small town. The Becoming happens to them in private (to each of them separately), and nobody sees them. For all their shock and horror at their transformation, the characters manage to survive Dark Day with their “normal” lives intact. Soon, they sense the presence of others of their kind (the other player characters, and some NPCs, good and evil). They also notice that something else is wrong with the town. A few powerful people (the chief of police, the mayor, the school principal, perhaps family members) are acting strangely. The truth is, the town’s notables have been replaced by Doppelgangers and Hollow People. Will the Nightbane discover this, or will they be victimized by the Nightlords’ minions? When they realize their world has been forever changed, how will they react? Again, play on their angst, confusion and discovery of a world transformed and in the clutches of a demonic conspiracy.

Allies: Human friends or relatives, fellow Nightbane.

Enemies: Terrified mobs, the police, and government agencies (who will want to capture and study Nightbane). As the Nightlords consolidate their power over the world, their minions will rear their ugly heads.

The Resistance Campaign

This campaign assumes that all or most of the player characters are affiliated with the *Resistance* or *Spook Squad* or similar Factions. The Resistance’s goal is to fight the Nightlords using direct, violent tactics. Spook Squad has similar goals, but is mostly controlled by humans. The characters must hide from both the Nightlord-controlled government, but also from humanity at large. Leading a normal life is difficult, if not impossible. Often, the group will be forced to flee from city to city (see the **Wanderers Campaign** suggestions). The player characters will be involved in guerrilla warfare (hiding in the wilderness, for example and fighting the NSB death squads, or hunting parties of Hounds), urban combat (trying to assassinate Nightlord Avatars and minions, or thwarting corrupt police, for example), protecting innocents (city patrols and rescuing victims from the Nightlord’s minions, vampires, and evil Nightbane, among others), and even cloak-and-dagger intrigue (like stealing valuable information from human servants of the Nightlords, or infiltrating spies into their organizations).

Military-style action will be common in such a campaign. If the players like their characters to wield all kinds of guns, bombs, and other implements of mass destruction, this would be the game for them. On the other hand, war is never pretty. Innocents can get killed, and if they are not careful, the Nightbane heroes could become as ruthless and bad as the enemy they are fighting. The Oklahoma bombing is a stark reminder of what happens when somebody decides to use violence to further his goals.

Direct violence is not likely to be constantly successful. Some measure of care, discretion and sneakiness will be necessary to survive. The Nightlords, through the control of law-enforcement

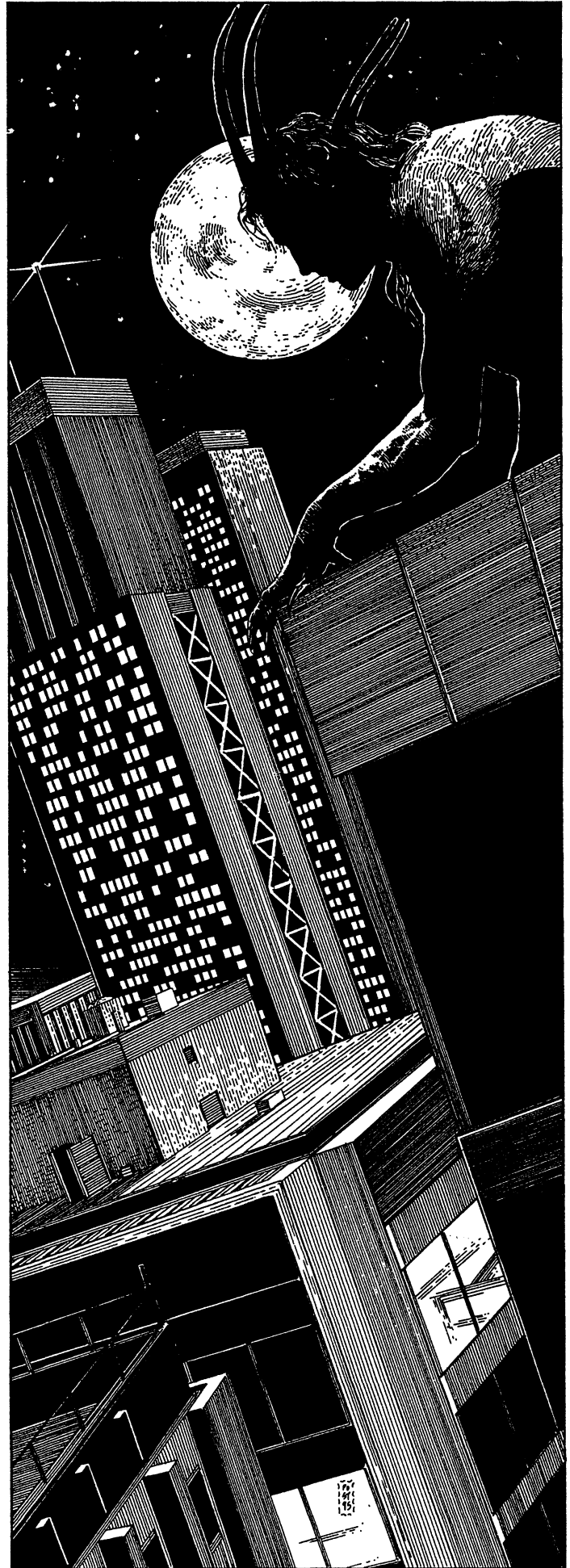

agencies, have more guns, military equipment and soldiers than the Resistance or any resistance group could ever hope to muster, not to mention the Ba'al's supernatural minions. Subtler tactics, like releasing proof of the Nightlords' plans to the public, exposing corrupt officials and police (servants of the Nightlords), surgical strikes against Nightlord operations, and sabotaging the efforts and organization(s) of the Nightlords, might produce more results for less risk.

A few Possible Plot Lines:

1. Somebody betrays the player characters' "cell." The characters must try to escape the city they were in, while the NSB conducts a systematic search and pictures of their Facades appear on *America's Most Wanted*. While they are running, the characters have to deal with the fact that a traitor *could* be in their midst.

2. The characters are sent to a Resistance training camp somewhere in the vast forests of the Northwest. Soon afterwards, however, a human "militia group" discovers that inhuman monsters (the Nightbane) are practicing with live ammo a couple of miles down the road, and they decide to do something about it. The humans have the edge in numbers and weaponry. The Nightbane have their powers, but may realize that these people are neither evil or pawns of the Nightlords, just frightened people trying to protect themselves from apparent monsters (bad guys as the humans see things). War explodes in the once tranquil forests. If the player characters are having too easy a time, have the NSB hear of the shoot-out and send out a huge team of agents, backed up by Hounds and Hunters (not to mention helicopters). Use the first *Rambo* movie for inspiration.

3. The player characters learn about a horrible plot and intend to do something about it.

4. To complicate an already grim situation, a (small) group of vampires or other supernatural predators are stalking the streets and preying on innocent humans.

5. Cross-fire. The characters get caught in the middle of a plot (or war) between the Nightlords and vampires or a Nightbane Faction or gang.

Possible Allies: Humans who learn about the Nightlords and wish to fight them; Second Amendment supporters; ex-soldiers; former "spooks" (government agents).

Antagonists: NSB agents (humans, Doppelgangers and Hollow Men); Hounds and Hunters.

The Wanderers Campaign

In this case, the player characters may or may not be directly fighting the Nightlords. Whatever their reasons or motives, the characters are on the run, traveling throughout the U.S. (or throughout the world), pursued by the minions of the Nightlords, the authorities, or other determined enemy. Or they may be searching for something: a powerful item to be used against the Ba'al, perhaps, or a particular person, or even for some answers and the truth.

This campaign may be inspired by such TV shows as *The Fugitive* or *The Incredible Hulk*; the characters rarely stay in one place for long, try to guard their secret (inhuman nature), do good when they can, and then move on.

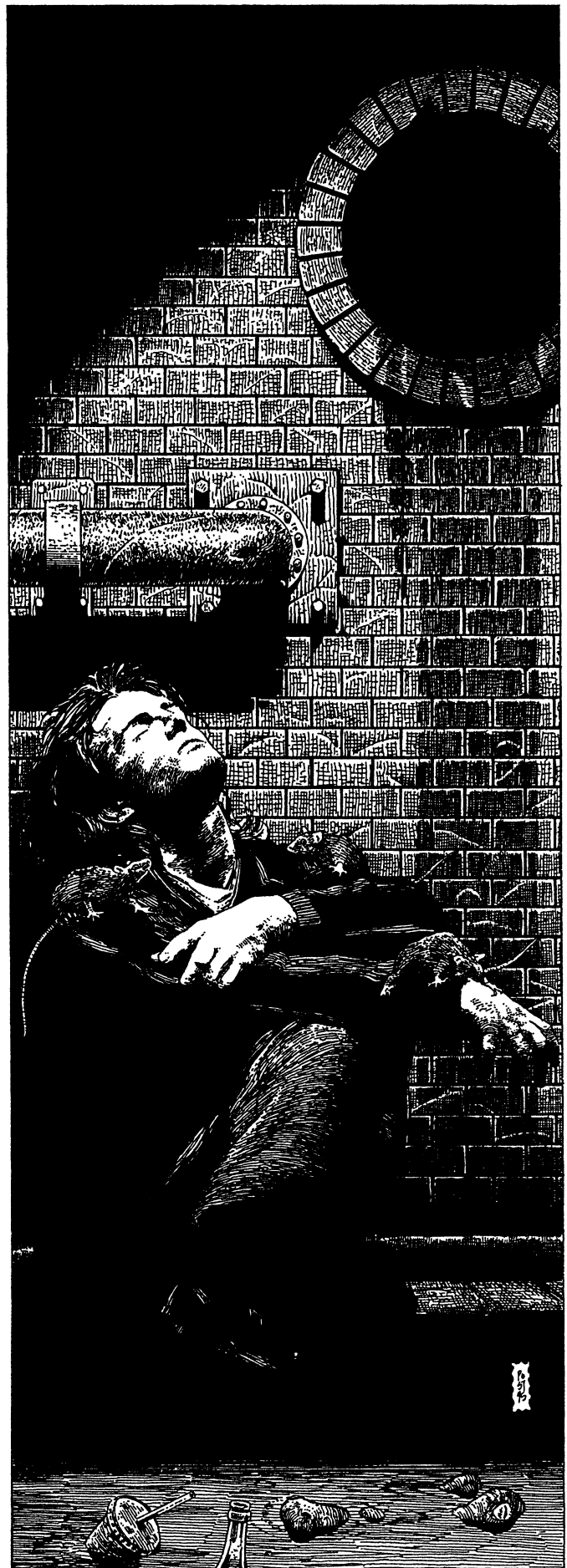

Possible Plot Lines:

1. The most common one: The player characters arrive in a new town/city and discover a problem that has little to do with their actual goals or personal predicaments. Maybe the people who take them in are being threatened by Doppelgangers, vampires, or even “normal” threats like a biker gang, corrupt politicians, and the like. Do they hang around long enough to help their new acquaintances, or do they move on? Does their help reveal their true nature? And if so, how does it affect them (are the Nightlords tipped off and do they send a hit squad to kill them? Do the authorities want them? Did they break the law? Do other evil forces try to manipulate or corrupt them for their own gain? Do friends or acquaintances in the town accept them, run away in terror or even attack them? And so on).

2. In an effort to escape their pursuers, or maybe to seek help, the Nightbane characters risk all and step into a dimensional Rift. Where do they end up and what new adventures or horrors must they face? It’s up to the G.M. At this point, the event can become a temporary side adventure or the campaign can move on to the larger canvas of the Palladium Megaverse. The characters might end up on Rifts Earth, Wormwood, the Palladium World, Phase World, an alternate Earth, or countless other places and times.



The Discovery Campaign

Characters who belong to the Seekers Faction are the most likely to be sent on missions of discovery. Both the Earth and the Nightlands still hold many secrets, some of which may help turn

the tide against the Nightlords. Ancient ruins, buried treasure, maybe even new supernatural races hiding in remote places, all of these can become the goal of an adventure or even an entire campaign. The goal could be more practical than simple knowledge; maybe the characters are searching for an ancient vampire intelligence to put an end to its centuries’ old evil, or they are on the trail of a spell of legend that might seal off the Mirrorwall and forever keep the two worlds apart.

The character will face many possible dangers: exotic locales are often home to dangerous animals and monsters, suspicious cultures, and natural threats like avalanches, earthquakes and tornadoes. Another group or faction might be after the same goal, and might decide to deal with the competition first. Movies like *Raiders of the Lost Ark* are good sources of inspiration and adventure ideas.

One Possible Plot Line:

The Nightbane Testaments: A human scholar has translated some fragments from an ancient scroll found in the Middle East. The translation indicates that a Nightbane kingdom may have existed in modern-day Jordan sometime in 4,000 B.C. More interestingly, the fragment suggests that this Nightbane Kingdom was instrumental in the defeat of the Ba’al thousands of years ago. The scholar does not know the significance of his find, but when his first findings are published, several factions move to acquire/steal the scroll.

Possible complications: The archeologist is murdered and the scroll vanishes; the player characters recover the scroll and follow its instructions to find the ruins of the Nightbane Kingdom; and maybe there is more in those ruins than anybody expected. Or the entire story could be false, a clever Nightlord plot to lure the most resourceful and daring Nightbane to their doom. Or the legend may or may not be true and the item is never found, but it leads the characters on a whirlwind of travel, exploration, discovery (about themselves and the Nightlords) and adventure.

The War of Light & Darkness

The conflict between the forces of light and darkness raged before humankind began to climb the evolutionary ladder, and it may go on after the Earth is cold and dead. The fall of the Ba’al and Moloch their king, was just one battle in this eternal struggle. Nightbane or others who join the war, will not only fight the Nightlords, but also the machinations of vampire intelligences, evil supernatural beings, demons, entities, cultists, and other creatures. This type of campaign is most appropriate for player characters associated with the Nocturnes or the Light-bringers. While fighting the Nightlords would still be the main focus of such a campaign, the G.M. can easily introduce other supernatural threats from game worlds such as **Beyond the Supernatural**, **Rifts** and even other “dark” RPGs. The result is a complex web of intrigue and conspiracies; the characters may only be aware of a few of them, until they stumble onto a new evil plot and perhaps, a new enemy.

The enigmatic Guardians could be the protagonists; their powers and dedication to protect humankind would put them at odds with most other supernaturals. Nightbane, renegade vampires or wampyrs, human mystics and psychics, and normal people who choose to battle the supernatural could all play a part.



One Possible Plot Line:

Urban Warfare: The party learns that a Nightlord Avatar has been destroyed and all Nightlord minions have been expelled from a large city (it should be near the player characters' current location). Somehow, the city has managed to become independent! Upon closer investigation, however, the characters discover that the people responsible for the expulsion of the minions of Night are none other than a powerful band of vampires (or other evil, inhuman force). More importantly, there are indications that enough vampires (over 2,000) have been created to bring to Earth one of the dreaded vampire intelligences. As the city falls into panic due to hundreds of vampire attacks and murders, the player characters are now caught in a war between the vampires and the Nightlord minions, who are attempting to re-take the city. If the characters play their cards right, however, they might help the two evil forces destroy each other, and maybe truly liberate the city.

Historical Campaigns

Nightbane are very long-lived, perhaps even immortal. An enterprising Game Master might want to run a campaign through the ages, running a group of Nightbane and jumping over decades or even centuries between adventures.

In the early days of Egypt or Greece, the Nightbane were often hailed as kings or worshipped as gods. By Roman times, they had been forced into hiding, and during the Middle Ages they were hunted down as demons or witches. The few Nightbane (rarely less than a couple of hundred worldwide, at least before the Dark Day) living during these periods usually ended up gathering in small groups — other Nightbane, and the occasional psychic or sorcerer, were the only beings they dared trust. The campaign focuses on the characters' lives and adventures in those exotic times.

This type of game works best when one or two of the players (and the game master) are history buffs; they can pick their favorite time period and have fun with it. How would Nightbane have influenced the ancient Egyptian Kingdoms, or the Roman Empire? Or how about Nightbane pirates in the Caribbean during the Age of Sail? Or Nightbane cowboys, riding the range and facing not only dangerous natives, cattle rustlers and desperadoes, but other Nightbane, vampires and occasional incursions from the Nightlands? Nightbane could prowl the fog-shrouded streets of Victorian London, or fight the Nazis during World War II. The possibilities are endless.

Some ambitious game masters might even run an extended campaign with a decades- or centuries-long gap between adventures. For example, the first session might chronicle the player characters first encounter during the chaotic years of the Fall of Rome. At the end of the adventure, the game master decides to run the next adventure 500 years later, during the early Middle Ages. The player characters can describe how they spent their intervening centuries (some players might decide to use different player characters in the later period), leading to the time of the next adventure. And the game could go on in this vein — all the way to the 21st century and Dark Day! A long campaign climaxing during the time of the invasion would result in the player characters being ancient movers-and-shakers, able to play a fundamental part in the forthcoming war.



Enemies & Minor NPCs

Described below are some “typical” enemies that may be encountered in the course of a Nightbane campaign.

Preserver Activist (“Preevert”)

This could be a member of the Preserver Youth or the more sinister Preserver Activist Groups. After the Nightlords consolidated power, these groups became swaggering vigilantes and bullies who love to intimidate and brutalize anybody who speaks up against the government. The “preeverts” idea of “American” excludes anybody who is not “white” enough, including most ethnic groups. The group attracts young, poorly educated men, many of whom were unemployed or working for minimum wage. The Preserver Party has given them a chance to be “somebody,” and they get to play with guns and push people around. They love it.

The Preeverts are well-armed, but are poorly trained and are little more than armed thugs. They are usually no match for Nightbane in a one-on-one confrontation, but the activists rarely travel in groups of less than four. If they are getting their

butts kicked, the Preeverts will not hesitate to call the police for additional support — most cops (many of which are not even human anymore) will rarely arrest or hinder the Preserver Activists, and will instead, turn against their victims.

While traveling, Preeverts favor pick-up, trucks, jeeps and vehicles with off-road capabilities, even if operating inside a city.

Number Appearing: 3-12 (3D4)

Alignment: Typically, any evil.

Attributes: Average or below average.

S.D.C.: 18

Hit Points: 12

Combat Skills: Hand to Hand: Basic; two attacks per melee.

Will also have one ancient W.P. (blunt or knife) and one or two modern W.P.s (revolver, pistol, rifle).

Level of Experience: First

Bonuses: +1 to strike and parry with hand weapon, +2 to pull/roll with punch.

Equipment: Knife (1D6), axe handle or baseball bat (1D8), 9 mm pistol (2D6) or .45 pistol (4D6), or a semi-automatic hunting rifle (5D6).

Description and Disposition: Preeverts dress in white T-shirts with the Preserver Slogan “Save America for Americans,”

leather jackets, black jeans, and combat boots. Most favor military-style crew cuts or completely shave their heads. They are bullies through and through. If they think you are weaker than they are, they will mock, insult or push you around. If faced with anybody in a position of authority, they become respectful and obedient. Despite their weaponry, they are not used to being shot at, or being in any sort of dangerous confrontation. Should they run into a firefight, the Preeverts should roll against a Horror Factor 10; those who fail their save will run away or surrender, depending on the situation (running away is always the first choice). The same if confronted with a Nightbane in Morphus form (use the Nightbane's Horror Factor).

Nightbane Gang Member

A member of the Golden Posse, the Warlords, or one of the dozens of smaller gangs around the U.S. (and the world). The gang members described below are hardened criminals, veterans of the violent streets of the inner cities. Most gang members are used to attacking helpless or surprised enemies, and are not used to targets that shoot back; being in actual combat against dangerous enemies calls for a roll against a Horror Factor of 8.

If the gang members belong to the Warlords, they will know of Nightbane, their often gruesome appearance, and their powers; this makes them less likely to run from Nightbane (see bonuses). Warlord gangs are sometimes backed by Nightbane: 10% chance if the group has 2-6 (1D4+2) members, 15% if it has more than 7 members. **Note:** Similar gangs may exist with vampires, Wampyrs, or other supernatural beings serving as members or leaders.



Number Appearing: 3-12 (3D4); occasionally one or two.

Alignment: Typically, anarchist or any evil.

Attributes: Either P.S. 17 or P.P. 17; all others average.

S.D.C.: 25

Hit Points: 15

Combat Skills: Hand to Hand: Expert, one archaic weapon skill (blunt, chain or knife), and two modern W.P.s (automatic pistol, automatic rifle or sub-machinegun).

Level of Experience: 2nd (1 in 5 are 3rd level, with higher combat bonuses)

Bonuses: +1 on initiative (aggressive and tough), +3 to parry and dodge, +2 to pull/roll with punch, +1 to strike and parry with weapon of choice, +1 to save vs Nightbane Horror Factor (Warlords only).

Equipment: Assorted handguns (typically 9 mm, inflicting 2D6), Uzi's (2D6 damage), or AK-47's (4D6 damage).

Description and Disposition: Swaggering and bullying, somewhat like the Preeverts (the two groups hate each other with a passion, however, and will shoot each other on sight). Love playing loud music on the streets, hanging out on the street, "tagging" street walls with graffiti, and intimidating passersby. Typically wear bandannas or jackets with their gang's colors (the Golden Posse favors yellow, while the Warlords use speckled red as their color).

Corrupted Police

The Nightlords have replaced most police officers in the world with either Doppelgangers or the worst possible human scum. The latter are typically fanatical Night Cultists, criminals, or corrupt, greedy or power-hungry police officers who love the chance to wear a badge and get away with murder (and/or reap personal wealth or power) as long as they follow orders. These villains can be as foul and cruel as the monsters they serve, and may engage in criminal activity of their own as a sideline (usually protection rackets, drug trafficking, extortion, and murder and robbery of Nightbane and dissidents, as well as other abuses of power).

Most post-Dark Day officers travel in pairs, usually driving in patrol cars. If they are confronted with armed and dangerous opponents, they will call in backup, and every police car nearby will join them, usually raising their numbers by as much as eight to ten in a matter of a few minutes. When facing dangerous subjects, such as a band of Nightbane holed up somewhere, they call in SWAT squads armed with heavy weapons and equipment, or contact the NSB.

Even the low-grade police officers used by the Nightlords have undergone full police training, and are capable opponents. While they are usually no match for equal numbers of Nightbane, their weaponry and ability to get reinforcements make them dangerous enemies.

Number Appearing: 2 in a typical squad car, and may have 2D6 additional officers available in 1D6 minutes.

Detectives often work in pairs or groups of three to six, half of which may be Doppelgangers, Hollow Men or other disguises minions of the Nightlords.

Alignment: Anarchist or any evil.

Attributes: One attribute at 17 (typically, P.S., P.P. or P.E.). Doppelgangers have supernatural P.S.



S.D.C.: 30 (human) or 50 (Doppelganger).

Hit Points: 16

Combat Skills: Hand to Hand: Expert, W.P. blunt, W.P. automatic pistol, W.P. shotgun, W.P. automatic rifle.

Level of Experience: 1st (1-20%), 2nd (21-60%), 3rd (61-80%) or 4th (81-00%). Bonuses below are for 1st level characters. Add one level to detective and ranking officers.

Bonuses: **Typical Evil Cop:** +1 on initiative, +2 to pull punch, +1 to roll with impact, +1 to strike and parry with police club (1D8 damage), +2 to save vs Horror Factor (Doppelgangers only).

Typical Evil Detective: +2 on initiative, +3 on perception rolls, +2 to roll with fall or impact, +2 to pull punch, +2 to strike and parry (any situation), and +4 to save vs Horror Factor (Doppelgangers only).

Equipment: Nightstick (1D8), 9 mm pistol (2D6), shotgun (4D6 or 5D6), Rifle (5D6; SWAT units only). Their bullet proof vests (when they wear them) have A.R. 10, and 50 S.D.C. SWAT units wear hard armor (A.R. 16, 260 S.D.C.).

Description and Disposition: This new crop of cops is often rude, cold, and intimidating. They offer a minimum of respect and politeness to “solid citizens,” but “perps” (and Nightbane) get pushed around, abused, and often beaten up or worse.

A diminishing minority are still dedicated peacekeepers trying to protect the citizenship from crime and their own (evil) members. These harried good cops will try to curb the abuses of the others, but risk being targeted for abuse or murder if they push things too far. Sometimes, these good cops will let suspects “escape” rather than allow them to be abused or killed by their evil counterparts. Others secretly provide information and support to militia groups, the Spook Squad, the Lightbringers and even trusted Nightbane. Many have resigned from the force and have gone underground to work closely with the above organizations or have started their own groups.

Night Cultist

This is a human, non-mystically gifted follower of one of the Cults of Night (for the description and powers of the cult leaders, see the **Priest of Night O.C.C.**). The Cults of Night are small groups based around a charismatic leader (the priest), who seduces and recruits impressionable people from all walks of life. The cultists are brainwashed and led to believe that they serve a higher power (true, but not in the way they expect), and that the cult is the only true family for them, the only place where they really belong. Most cultists were afflicted with low self-esteem or had severe mental or social problems before being inducted into the cult (roll on the optional **Random Insanity Table**). Some of these lost souls are not wholly corrupted, and might turn against their masters if they realize the truth about the Nightlords. Unfortunately, many more simply do not care who they serve.

Cults of Night can have any sort of headquarters, from the mansion of a wealthy “convert” to a condemned building in the slums to a small compound in the middle of the desert. The cultists often participate in ritual magic (freely giving their life energy to their evil leaders; see the **Magic Section**), but do not have any practical magic knowledge themselves. Their dedication often makes them dangerous opponents, and sometimes immune to fear (see bonuses).

Number Appearing: 3-18 (roll 3D6) in a small cult. Larger cults might have as many as a hundred members, including whole families.

Alignment: Typically evil, occasionally anarchist.

Attributes: Average

S.D.C.: 16

Hit Points: 12

Combat Skills: Hand to Hand: Basic and two Weapon Proficiencies (any).

Level of Experience: 1-4 (roll 1D4); bonuses below are for a 1st level character.

Bonuses: +2 to roll with punch/impact, +3 to save vs Horror Factor (fanaticism).

Equipment: The cultists will use anything, from improvised weapons (kitchen knives, tools, etc., inflicting 1D4 to 1D8, but at -1 to strike due to unwieldiness) to handguns, rifles and even a few military small-arms.

Description and Disposition: Cultists run the whole gamut from “happy, shiny” people offering flowers to dark-robed wild-eyed fanatics who mutter to themselves as they stab their victims over and over. More insidious are the cultists who appear to be normal or even successful men and women. Some cults controlled by Night Princes or Nightlord Avatars have recruited a number of prominent businessmen, actors and actresses, and other “movers and shakers.” Anybody, anywhere, may be a dupe of the Nightlords. Paranoia may be the only way to survive.

Note: A cult leader could be a Night Prince, Nightlord Avatars Doppelganger, Night Priest, Sorcerer or even an evil Nightbane or other shape-changing inhuman.

NSB Agent

This is a Doppelganger agent; in addition to these two types, NSB agents can be **Ashmedai** or **Hollow Men** (see those R.C.C.s for their powers and abilities). The NSB, the National Security Bureau, is the Federal super-agency that has replaced the FBI, ATF, DEA and the rest of the “alphabet soup” law-enforcement agencies. Almost every NSB field agent is a Doppelganger, Ashmedai or supernatural creature. Granted unprecedented powers, the NSB can do pretty much as it pleases, and its members are well-armed and trained. This fighting elite is

very dangerous, even against Nightbane, and they prefer to use overwhelming force against their targets. A raid by this agency will consist of at least 12 agents per “suspected” target in the area, backed up by heavy weapons and even some military vehicles! The best hope for the targets is to flee; an armed confrontation is likely to be lethal.

Number Appearing: 2 for an investigative team, 3D6 for a field team, and as many as 50 on a major raid.

Alignment: Any evil.

Attributes: P.S. 17 (supernatural), P.E. 17.

S.D.C.: 65

Hit Points: 30

Combat Skills: Hand to Hand: Martial Arts

Level of Experience: 4th

Bonuses: +3 to strike, +4 to parry and dodge, +2 to pull/roll with punch, +1 to save vs magic, +2 to save vs horror factor (includes attribute bonuses)

Equipment: NSB agents are assigned Beretta 95 machine pistols (damage 2D6, 20-round magazine, can fire bursts and full automatic), or heavier weapons (M-16 rifles typically) if the situation demands it, as well as hazardous duty battle armor (A.R. 16, 260 S.D.C.).

Description and Disposition: The agents are cold and distant, apparently lacking any emotion. They have a “just the facts, ma’am” attitude towards most civilians; neither pleas for mercy nor threats affect them in the least. They do their job coldly and efficiently, and will not hesitate to kill witnesses who see something they shouldn’t have. Very rarely, a Dop-



pleganger agent may turn out to have feelings after all, and may show mercy and even turn against his fellows. This happens very rarely, if at all.

The agents, both men and women, dress conservatively, favoring dark suits and shades. During dangerous raids they wear intimidating black body armor, complete with face plates, with “NSB” prominently displayed in white.

Using Other Palladium Books in Nightbane (and vice versa)

Beyond the Supernatural

Beyond the Supernatural can make an excellent companion for **Nightbane**. As the existence of vampires shows, there are more supernatural beings and forces on Earth and the Nightlands than anybody suspects. For Game Masters wishing to introduce more variety in their game, the horror bestiary of BTS will be very useful. Some care should be taken not to introduce too many additional supernatural creatures in a campaign to prevent the “monster-mash syndrome”: so many different critters that the game becomes silly. Other supernatural villains are likely to be rare and probably subtle.

Beyond the Supernatural also offers a variety of additional human character classes including psychics, the parapsychologist, arcanist, psi-mechanic, and nega-psychic.

Another possibility is to run a **Beyond** campaign in the **Nightbane** world, using that book’s Psychic Character Classes (P.C.C.s) as the main characters, as well as the **Nightbane**. Options on using human psychic characters (and extended conversion notes for **Beyond the Supernatural** P.C.C.s) will appear in the **Nightbane Sourcebook One: Spook Squad**. In the meanwhile, the P.P.E. and I.S.P. available to these classes should be doubled or tripled, to reflect the increased mystical energies available on Earth after the coming of Dark Day.

The Palladium RPG

An interesting twist on the **Nightbane** world would be to introduce the Nightlords to the Palladium fantasy world. What if the Nightlords attempted to conquer that world of magic and heroes? Adapting the Palladium RPG system to the S.D.C. system of all the other Palladium games is not overly difficult (**Nightbane** characters should probably see their hit points/S.D.C. and bonuses reduced by half).

The fantasy world of the Palladium RPG would be harder to fool and deceive than 21st Century Earth, but it may still be overwhelmed by dark armies of Hounds and other evil minions. The Nightlords might even be servants of the dreaded Old Ones, and Dark Day could be the first step in an effort to awaken those evil and powerful beings.

Although **Nightbane** are more powerful than most normal fighters and men of magic, a combined group of supernatural and human characters is still possible. Under the circumstances,

Game Masters might want to be more generous than usual with regards to magical weapons and items, just to give the “normals” the edge they need to survive in the face of the supernatural dangers.

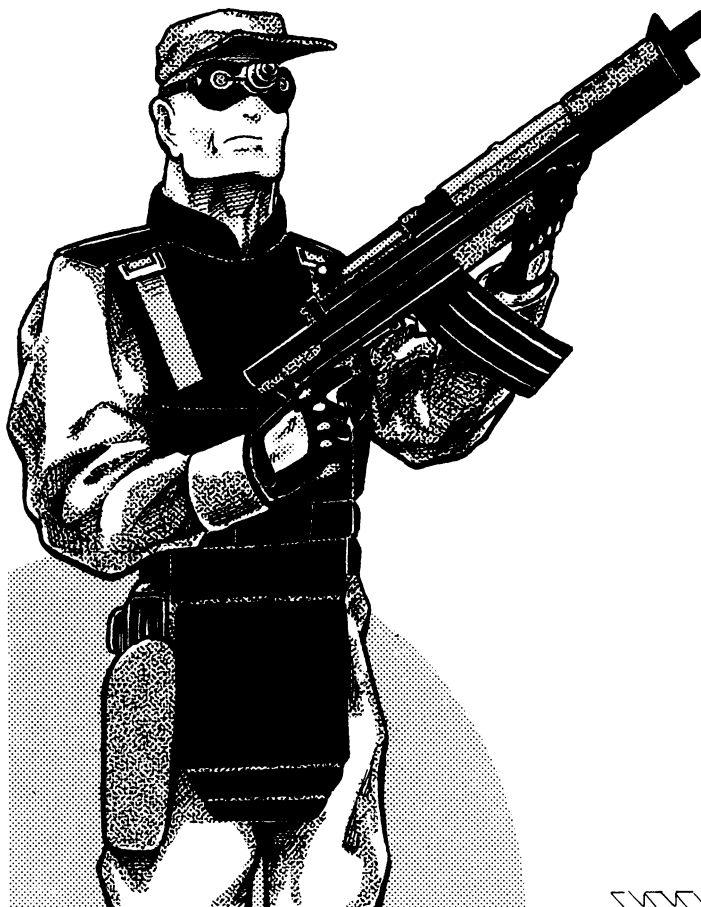

Recon Modern Combat

This upcoming RPG deals with modern combat, secret agencies, police procedures and other themes from the “techno-thriller” genre. Characters and military hardware will fit into **Nightbane** with little or no conversion necessary. Game Masters wishing to get more ideas and O.C.C.s for their campaign may look to this book for inspiration. Also take a look at **The**

Compendium of Contemporary Weapons for information on hundreds of modern-day weapons, plus data on body armor, explosives, riot control, and armored vehicles.

Rifts®

In the context of the **Rifts** game, the world(s) of **Nightbane** are a special area of the Megaverse, one that is very difficult to reach normally. Occasionally, a Rift may open, connecting the Earth of Nightbane to Rifts Earth, Wormwood, Phase World, and other dimensions. Due to the protective barriers erected by the Night Lords, only living things, organic material and magical articles can travel through those Rifts. Unliving things (including robots, cyborg limbs and all weapons) are disintegrated in transit; so does any artificial clothing (cotton, wool and linen articles will survive, and even some blends, but pure rayon, polyester and plastic will not).

In the Nightbane environment magic and psionics inflict S.D.C. damage. Supernatural beings and creatures of magic are weakened and reduced to their S.D.C. equivalents.

If a Nightbane is transported to Rifts Earth or other places of mega-powerful magic, all of his hit points and S.D.C. become M.D.C. Their strength is considered to be supernatural (see **Rifts Conversion Book One**, page 22, for supernatural damage in an M.D.C. environment). The same applies for all supernatural beings from the Nightlands. Vampires use the rules in **Rifts Vampire Kingdoms**.







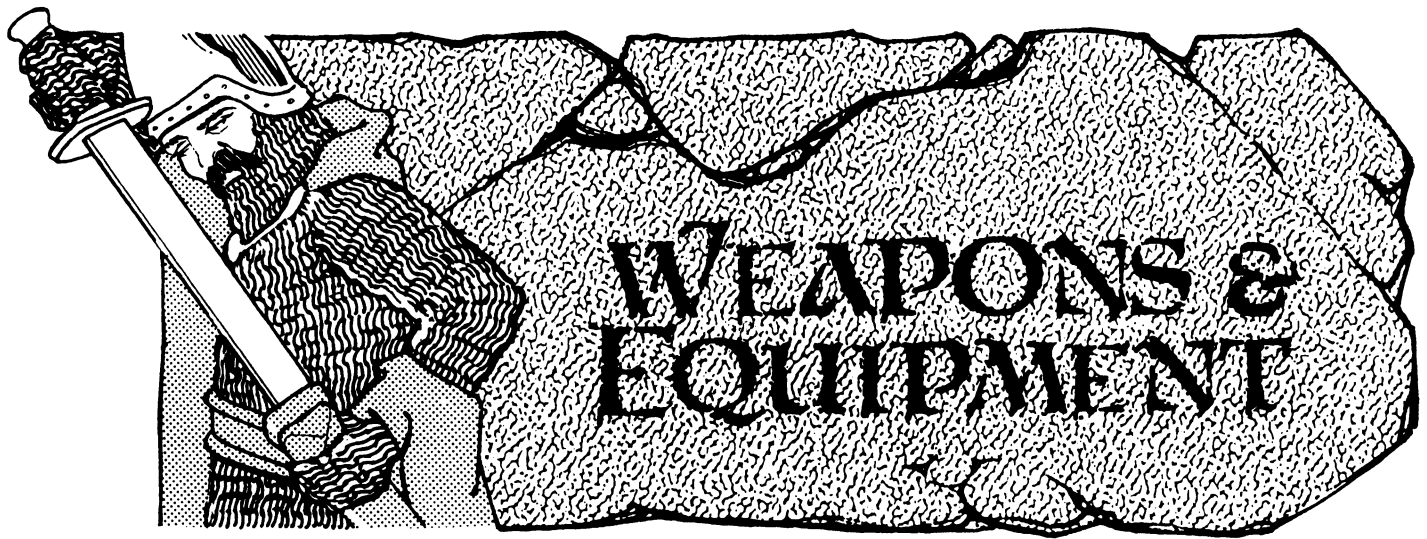



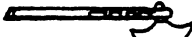

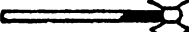
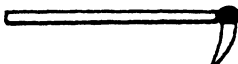
Bringing Dark Day to Rifts Earth: An interesting “what if” campaign would involve using the Nightlands and the invasion that starts with Dark Day in a Rifts setting. Or perhaps limited to one particular nation or continent?

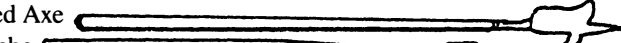
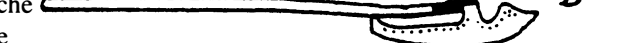
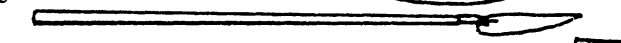
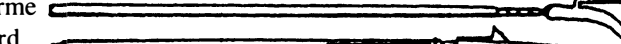

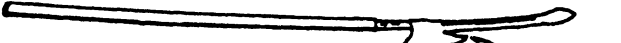
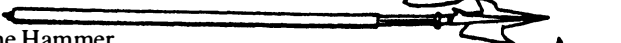
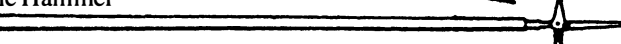
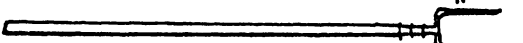
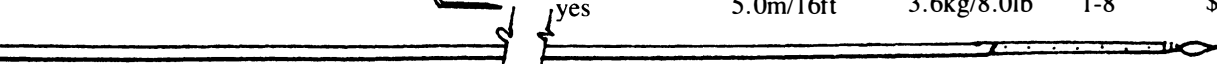
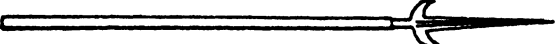
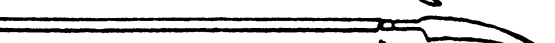
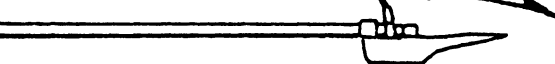



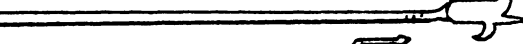
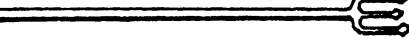
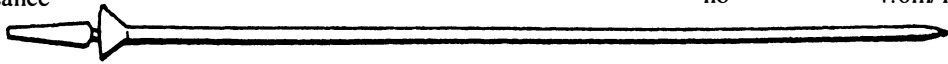



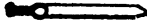

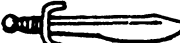

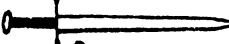

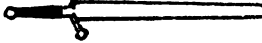

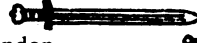
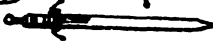

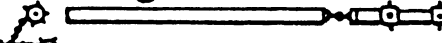

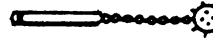

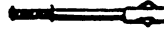
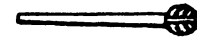

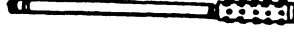

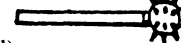

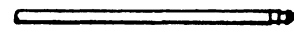
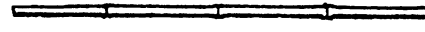
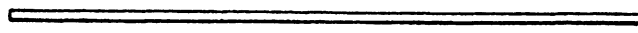



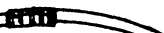
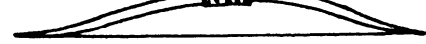



How would the nations, entities and heroes of Rifts deal with this supernatural threat? A secret takeover would be short of impossible, because of the many psionic and magical beings and countermeasures available even in such places as the Coalition States. That would leave an actual military invasion. The Nightlords might ally themselves with such evil entities as the Splurgoth, the Gargoyle Kingdom, death cults, gods of darkness, and supernatural monsters. They would be fierce enemies of vampires (and the Vampire Kingdoms), Naruni Enterprises, all the human nations (both magical and technological), cyber-knights, True Atlanteans, and any champions of light.



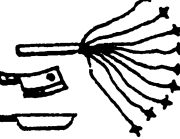

ANCIENT WEAPONS

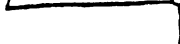
Type	2-Handed	Avg. Length	Avg. Weight	Damage	Avg. Cost
AXES					
Axe, Battle 	no	.8m/2.75ft	2.0kg/4.6lb	2-12	\$240
Axe, Throwing 	no	.4m/1.25ft	1.4kg/3.0lb	1-6	\$100
Axe, Stone 	no	.6m/2.0ft	1.8kg/4.0kg	1-8	\$100
Axe, Bipennis (2-head) 	no	.8m/2.75ft	2.8kg/6.0lb	2-12	\$120
Oncin Pick 	yes	1.0m/3.75ft	1.8kg/4.0lb	1-8	\$220
POLE ARMS					
Awl Pike 	yes	3.2m/10ft	2.7kg/6.0lb	2-12	\$445
Beaked Axe 	yes	2.3m/7.5ft	2.3kg/5.0lb	2-12	\$540
Berdiche 	yes	2.1m/7.0ft	3.2kg/7.0lb	2-12	\$550
Glaive 	yes	2.3m/7.5ft	2.7kg/6.0lb	2-12	\$540
Guisarme 	yes	2.5m/7.25ft	2.7kg/6.0lb	2-12	\$550
Halberd 	yes	2.2m/7.25ft	2.3kg/5.0lb	3-18	\$660
Sabre Halberd 	yes	2.4m/8.0ft	3.2kg/7.0lb	3-18	\$650
Hippe 	yes	2.3m/7.5ft	2.7kg/6.0lb	3-18	\$750
Lucerne Hammer 	yes	2.9m/9.75ft	2.9kg/6.5lb	2-12	\$540
Military Fork 	yes	2.1m/7.0ft	2.3kg/5.0lb	1-8	\$330
Pike 	yes	5.0m/16ft	3.6kg/8.0lb	1-8	\$445
Runka 	yes	2.3m/7.5ft	2.7kg/6.0lb	2-12	\$445
Scythe 	yes	2.4m/8.0ft	2.3kg/5.0lb	1-8	\$445
Voulge 	yes	2.1m/7.0ft	2.3kg/5.0lb	3-18	\$550
SPEARS					
Short Spear 	no	1.2-1.8m/4-6ft	1.8kg/4.0lb	1-6	\$130
Long Spear 	yes	2.1-3.0m/7-10ft	2.9kg/6.5lb	1-8	\$180
Javelin 	no	2.1m/7.0ft	1.8kg/4.0lb	1-6	\$180
Beaked Axe 	no	1.4m/4.5ft	2.3kg/5.0lb	1-8	\$430
Trident 	yes	1.5m/5.0ft	1.8kg/4.0lb	1-8	\$240
Lance 	no	4.0m/13ft	3.6kg/8.0lb	1-8	\$460
KNIVES					
Daggers and Knives 	no	.2-.5m/10-20in.	.5kg/1.0lb	1-6	\$30-100

Type	2-Handed	Avg. Length	Avg. Weight	Damage	Avg. Cost
SHORT SWORDS					
Short Sword 	no	.7m/2.5ft	1.4kg/3.0lb	1-6	\$240
Sabre 	no	.6m/2.0ft	1.4kg/3.0lb	1-6	\$230
Scimitar 	no	.7m/2.5ft	1.5kg/3.5lb	1-6	\$235
Falchion 	no	.8m/2.75ft	1.8kg/4.0lb	1-8	\$350
Cutlass 	no	.6m/2.0ft	1.4kg/3.0lb	1-6	\$235
LARGE SWORDS					
Bastard 	yes	1.0m/3.75ft	2.1kg/4.5lb	1-8 + 2	\$450
Broadsword 	no	.9m/3.0ft	1.6kg/3.5lb	1-8	\$340
Claymore 	yes	1.2m/4.0ft	2.9kg—6.5lb	2-12	\$560
Flamberge 	yes	1.3m/4.25ft	3.4kg/7.5lb	3-18	\$670
Long Sword 	no	.9m/3.0ft	1.6kg/3.5lb	1-8 + 2	\$455
2-handed Espandon 	yes	.9m/3.0ft	2.1kg/4.5lb	2-12	\$460
BALL and CHAIN					
Ball and Chain 	no	.9m/3.0ft	2.1kg/4.5lb	1-8	\$250
Flail 	yes	1.6m/5.25ft	2.5kg/5.5lb	2-12	\$355
Goupillon Flail 	yes	.5m/2.0ft	2.1kg/4.5lb	3-18	\$460
Mace and Chain 	no	.9m/3.0ft	2.1kg/4.5lb	2-12	\$280
Nunchaku 	yes	.8m/2.75ft	1.1kg/2.5lb	1-8	\$30
BLUNT WEAPONS					
Arab Mace 	no	.6m/2.0ft	1.4kg/3.0lb	1-8	\$240
Mace 	no	.7m/2.5ft	2.0kg/4.5lb	1-8	\$240
Cudgel 	no	.8m/2.75ft	1.0kg/2.5lb	1-8	\$240
Club/Stick/Pipe 	no	.8m/2.75ft	1.4kg/3.0lb	1-6	\$10
Hercules Club 	yes	1.2m/4.0ft	2.5kg/5.5lb	2-12	\$260
Horseman Hammer 	no	.8m/2.75ft	1.6kg/3.5lb	1-8	\$145
Maul 	no	1.2m/4.0ft	2.0kg/4.0lb	1-6	\$100
Morning Star 	no	.8m/2.75ft	1.0kg/2.5lb	1-8	\$240
War Club (wood) 	no	.9m/3.0ft	1.4kg/3.0lb	1-6	\$75
War Hammer 	no	.7m/2.5ft	2.1kg/4.5lb	1-8	\$190
STAVES					
Short 	no	1.2-1.8m/4-6ft	1.4kg/3.0lb	1-6	\$120
Long 	yes	1.9-2.7m/7-9ft	2.3kg/5.0lb	1-8	\$125
Bo Staff 	yes	2.8m/9.5ft	1.4kg/3.0lb	1-8	\$140
Quarterstaff 	yes	1.8m/6.0ft	1.5kg/3.5lb	1-8	\$130
Iron Staff 	yes	1.8-2.1m/6-7ft	3.2kg/7lb	1-8 + 2	\$245
MISSILE WEAPONS					
Short Bow 	yes		1.0lb	1-6	\$130
Arrows 	no				\$20/dozen
Long Bow 	yes		2.0lb	2-12	\$270
Arrows 	no				\$40/dozen
Cross Bow 	yes	Range: 500-700ft	7.0lb	1-8	\$160
Bolts 	no				\$35/dozen
Sling 	no		2.0oz.	1-6	\$40
MISCELLANEOUS (no W.P. bonuses)					
Black Jack 	no	10in	1.4kg/3.0lb	1-4	\$10
Dart 	no	6.0in	6oz.	1-4	\$2
Bull Whip 	no	2.4m/8.0ft	1.4kg/3.0lb	1-8	\$60
Cat-o-Nine Tails 	no	.8m/3.0ft	.5kg/1.0lb	1-6	\$100
Meat Cleaver 	no	.3m/1.0ft	.5kg/1.0lb	1-6	\$10
Frying Pan 	no	.3m/1.0ft	.5kg/1.0lb	1-6	\$10
Hand Pick 	no	7.0in	8.0oz.	1-4	\$5
Large Pick/Mattock 	yes	1.2m/4.0ft	2.3kg/5.0lb	1-8	\$50
Shovel 	yes	1.2m/4.0ft	2.0kg/5.0lb	1-6	\$40
Hammer (tool) 	no	10in	1.4kg/3.0lb	1-4	\$10

ANCIENT ORIENTAL WEAPONS

ANCIENT WEAPON DESCRIPTIONS

Aikuchi/Tanto

These are curved Japanese daggers. The Tanto has a hilt, the Aikuchi does not. This weapon can also be thrown. **Cost:** Varies according to quality and beauty, from \$20 to \$1,000. **Damage:** 1D4.



Bisento

This spear features a broad, curved blade and is large enough to be considered a kind of pole arm. This weapon must be imported from Japan. **Cost:** \$600. **Damage:** 2D6.



Blow Gun

The blow gun is a favorite weapon of the ninja. Effective range is no more than 50ft. **Cost:** \$45.00. **Damage:** The dart itself does no damage; however, it is usually coated with poison or drugs.

Bo Staff

Although staff weapons have appeared in virtually every culture worldwide, the techniques of use were probably most advanced in the martial arts schools of samurai Japan. The size of the Bo Staff should be about a foot taller than the height of its owner. **Cost:** \$120. **Damage:** 1D8.

Bows

Ninjas favored a short, none too powerful, bow that could be disassembled and easily hidden. A separate skill learned by the ninja is that of the Samurai Long Bow, probably the most powerful weapon of its type in the world. Effective range for the ninja bow is 400ft, for the samurai bow it is 800ft. **Cost:** \$500 for ninja bow, \$1,000 (or more) for a high quality samurai bow. Modern commercial hunting bows cost: \$200. **Damage:** 1D8 — Ninja Bow, 2D6 — Samurai Bow, 1D10 — Modern Bow.

Crossbows

Crossbows are now commonly available by mail order in the U.S. **Cost:** \$300 for heavy crossbow, \$150 for pistol style crossbow. **Damage:** 2D6 for heavy, two-handed crossbow; 1D10 for 40lb, *pistol style* crossbow.

Daisho

Literally, "the long and the short," this is the traditional Japanese weapon made up of a Wakizashi and a Katana which

can be used as paired weapons. Using both of these weapons together is a separate skill. **Cost:** As little as \$150 for fair quality and \$1200 for an authentic high quality. **Damage:** 1D8 + 2 (long), 1D6 (short).

WAKIZASHI
SHORT SWORD

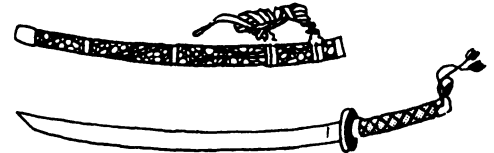

KATANA
LONG SWORD

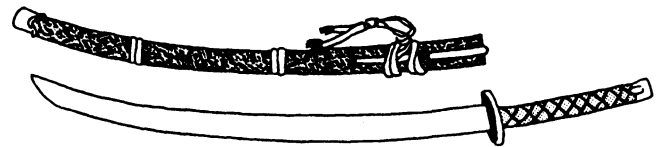

Jitte or Sai (Paired Weapons)

These weapons look like oversized, three-pronged forks and are generally designed to be used as a pair, one in each hand. They are excellent for countering the massive attack force of the samurai sword blade. A skilled user can entangle an opponent with one hand and attack with the other. **Cost:** \$50/pair. **Damage:** 1D6.

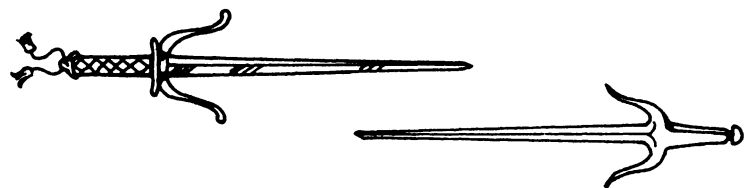

Katana

This is the primary weapon of the Samurai warrior; a long sword up to 3ft in length. There is an enormous difference in the quality of these weapons. **Costs:** For manufactured versions could be as little as \$300. A top quality sword could cost at least \$5,000. **Damage:** 2D6 for regular quality, 3D6 for top quality (authentic).

Kusari-Gama/Kyoketsu-Shogi

The combination of a chain with a weight on one end and a sickle weapon on the other is another ninja favorite. The Kyoketsu-Shogi is made with rope and has an iron ring on one end and a double blade on the other. With both weapons, one end can be used for an entangle while the other is still available for striking. It is usually used as a climbing device, but doubles

as a somewhat less damaging Kusari-Gama. Neither of these weapons can be used by anyone not trained in hand to hand martial arts or assassin. The Kyoketsu-Shogi costs \$100, the Kusari-Gama is \$300. **Damage:** 1D8 for the Kyoketsu-Shogi, 1D10 for the Kusari-Gama.

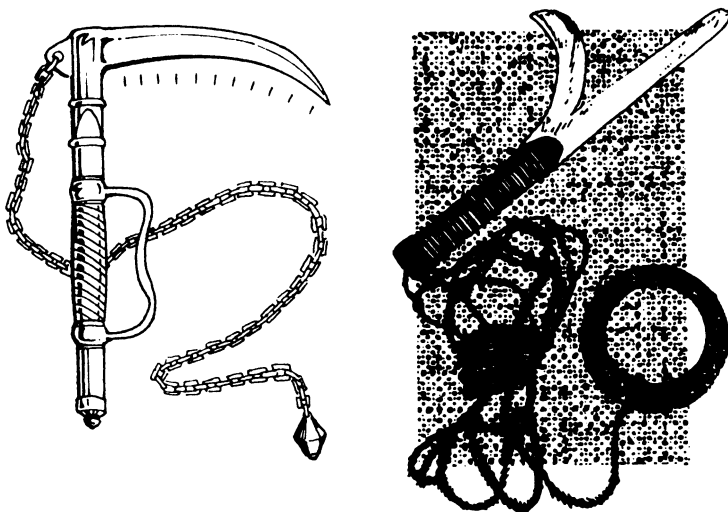

Kawanga

Ninja combination of a rope and grapple used for climbing and fighting. This is a separate chain weapon. **Cost:** \$50. **Damage:** 1D8.

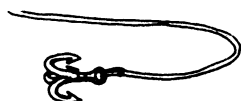

Manriki-Gusari

Chain weapon with solid, blunt weights on each end. It can be used like a Kusari-Gama, entangling with one end, striking with the other. This is a weapon which is easy to disassemble and conceal. It is also easy to make a Manriki-Gusari from a length of chain and lead weights found in any hardware store. **Cost:** \$30. **Damage:** 1D8.

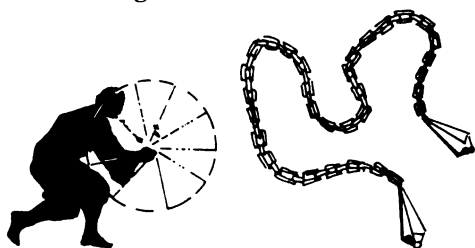

Naginata/Yari

Naginata have curved blades and Yari have straight blades. Otherwise, both of these weapons are alike and used as spears. They are very difficult to conceal. **Cost:** \$150. **Damage:** 1D8.

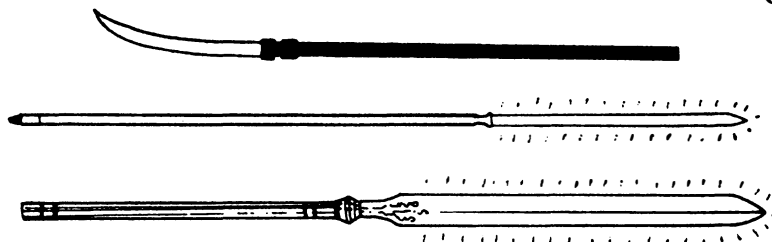

No-Dachi

This huge two-handed sword does much more damage than most weapons in its class. 5 to 6ft long and carried on the back, the weapon is pulled from the scabbard over the shoulder. **Cost:** \$750 and up. **Damage:** 3D6.

Nunchaku

Nunchaku (usually called “Numchuks”) can be used as a paired weapon for striking. One of the main advantages of Nunchaku is for entangle and this can only be done if one weapon is used with two hands. **Cost:** \$30 each. **Damage:** 1D8.

Sa Tjat Koen

This Malaysian weapon looks like Nunchaku with a second chain and third handle attached. Can be used to entangle like nunchaku. Can *not* be used as a paired weapon. **Cost:** \$150. **Damage:** 1D10.



Shikomi-Zue

Ninja commonly disguised themselves as blindmen and carried this hollow bamboo staff with a concealed blade. The blade is spring loaded, and the release is controlled with a trigger stud that can be pressed or turned. Weapon can be used as a somewhat fragile (S.D.C. 50) Bo Staff or as a spear. **Cost:** \$150. **Damage:** 1D8.

Shuriken

The famous “throwing stars” of the ninja were not designed for deadly effect so much as for their ease of concealment and usefulness in discouraging an opponent’s pursuit. Throwing knives requires a different technique than shuriken. **Cost:** High quality shuriken are \$5.00 each, high quality throwing knives are \$3.00 each. **Damage:** 1D4.

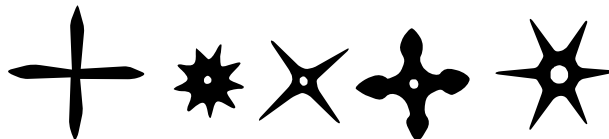

Wakizashi

This is the short sword favored by the samurai. The ninja short sword has a straighter blade, but it is otherwise just like a wakizashi. **Cost:** Varies according to the quality (see Katana for prices). **Damage:** 1D8 for regular quality, 2D6 for top quality.

Tonfa

A short wood weapon ideal for parrying and close combat. **Cost:** \$40. **Damage:** 1D6.

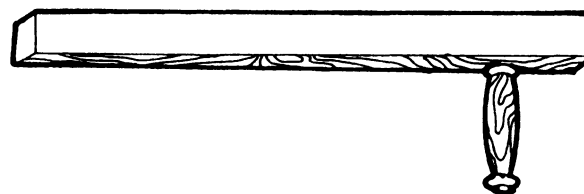

NINJA EQUIPMENT

The Ninja have developed a number of specialized tools and weapons to aid their missions. These weapons are often provided by Ninja organizations or built by the Ninja himself. Ninja equipment is generally not commonly available to the public.

Climbing Claws: Also called Tekagi or Shuko. There is usually a metal or leather band that wraps around the palm between the thumb and fingers. The inside surface has from two to six spikes that are helpful in climbing wood and stone surfaces. Adds +15% to climbing skills. **Cost:** \$85/pair.

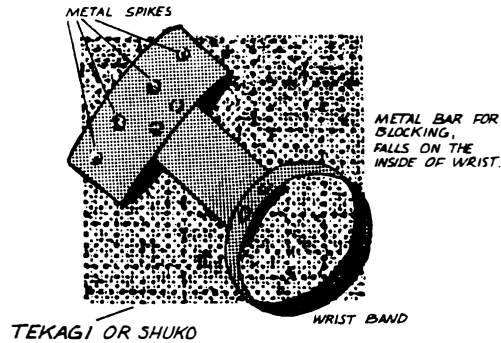

USED AS A CLIMBING TOOL AND WEAPON
DAMAGE RATING: 1

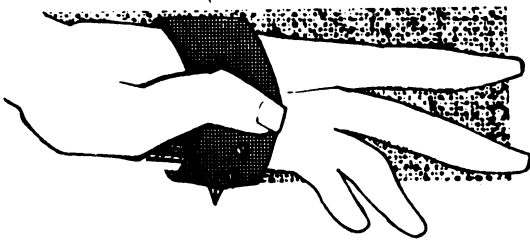

Climbing Spikes: These are spiked claws that are attached to the soles of the feet for climbing. Note that normal walking or running is impossible while wearing these. Add +15% to climbing skill. **Cost:** \$45/pair.

Eggshell Bomb: This is an eggshell filled with pepper, metal shavings and other secret substances. When tossed, it will shatter and a small cloud of blinding, irritating smoke will come out. Does no damage, but all victims must save against poison gas. **Cost:** \$5.00 each. Blinded victims are -6 to strike, parry and dodge.

Ippon-Sugi Nobori: A special tool used ONLY for climbing trees and telephone poles. A short length of spike-studded wood with ropes attached to each end. This is used much like a lumberjack's or lineman's leather climbing belt. Add 25% to climbing skill. **Cost:** \$25.

Ninja Emergency Kit: This is an assortment of items that a Ninja might need in case of trouble. Ninjas will keep several of these kits hidden in various places. Included in a small cloth bag would be a Kyoketsu-Shogi, 6 Shuriken, 12 Caltrops, a 3ft towel, a small cooking pot, paper and pencil, matches, first-aid kit (bandages, disinfectant, small scissors, painkiller), lock picks, spare clothing, and an eggshell filled with blinding powder. Enough rice, soybean curd and tea would be included for 7 days of tight rations. **Cost:** \$120.



Ninja Clothing: Comes completely black for concealment in darkness or completely white for snow. Consists of jacket, hakama (pants), tabi (socks), and belt. Leggings, and separate sleeves fitted from elbow to back of hand, a groin protector and a body protector are made out of quilted padding and used as protection. There are numerous pockets and compartments used to conceal shuriken, garrote, caltrops, lock picks and other Ninja items. **Cost:** \$600.

Rope and Chain: Available in just about any hardware store. Modern rope and chain is usually well tested and reinforced. Cost varies according to thickness and tensile strength. **An average cost** for chain would be about \$1.00 per foot, about \$.25 per foot for rope.

Rope Ladder: This Ninja rope ladder has loops knotted into it every two feet or so (depending on the height of the owner). There is a 3 pound weight attached to the bottom end. The top end is often tied to a grappling hook. This item is easy to use and easy to conceal. **Cost:** \$.75/foot.

Tetsubishi: *Ninja caltrops* come in a variety of styles. All are designed so that metal barbs will point upwards no matter how they land on the floor. Damage is rarely more than 1 point, but someone with a caltrop in their foot isn't likely to continue walking until they pull it out. **Cost:** \$2.00 each.

OTHER ANCIENT EXOTIC WEAPONS

African Throwing Knives: **Cost:** \$80-\$150. **Damage:** 1D8.

THROWING IRONS

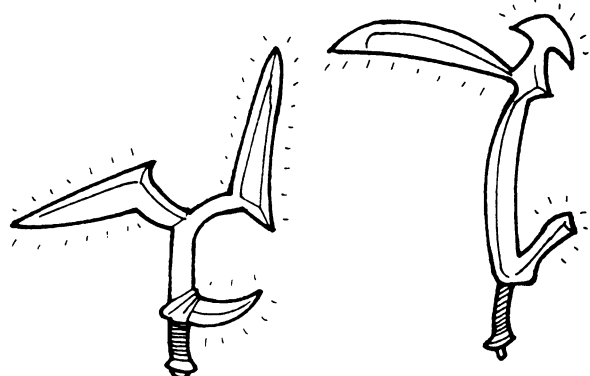

WEAPONS

NOTES ON MODERN CONVENTIONAL WEAPONS

Explosives: Most hand grenades should be treated as thrown weapons. Grenade launchers are used as Weapon Proficiency – Rifle. See equipment section for more information.

Reloading: Almost all modern weapons come equipped with easy-to-load clips (magazines). There are even quick-loaders for revolvers. This means that attackers can fire a full clip every melee. However, older weapons (bolt-action, muzzle-loaders, hand loaded revolvers) and most shotguns will require a full melee round (or more) to reload. Note that it will take much longer to reload while in the thick of hand to hand combat.

Effective Range: This is the longest distance that the weapon can be fired without losing accuracy or damage. Guns can be fired beyond their effective range, but with no W.P. Skill Bonus and with a –4 to strike for every 25 feet beyond the effective range.

Moving Targets: It is a lot harder to hit someone while they are moving. –3 to strike at moving, running or leaping targets. –6 to strike anything speeding 40mph or more.

Strike Bonus: Physical Prowess (P.P.), Physical Training and other strike bonuses *Do Not Apply* to modern weapons. When using a gun, only the W.P. Skill bonuses with that weapon can be used. For example, a character with +5 to strike in hand to hand combat and level 1 skill in revolver would have a +3 Bonus to Strike for an aimed shot.

TISSUE DAMAGE RATING

Since the major factor in the damage of a particular weapon is the type of shell used, we have developed a Damage Rating based on the cartridge types. The cartridges listed are considered the most common and universally used.

The tissue damage indicates the suggested amount of damage (dice) caused by a particular weapon. This is by no means a definitive evaluation of its effectiveness in the real world. However, it is what we believe to be an acceptable translation of effectiveness to role-playing games. Those of you who have firsthand knowledge to believe otherwise, feel free to adjust these ratings as you see fit. Game masters, you should not be intimidated by a player who swears that these ratings are not accurate. If you are comfortable with these ratings then stick to them, or do some research to confirm them. We are personally confident that the rating system is a fair and reasonable adaptation.

TISSUE DAMAGE RATINGS

Damage Rating	Tissue Damage
1. Barely Adequate	1D6
2. Fair	1D8
3. Good	2D6
4. Very Good	3D6
5. Excellent	4D6
6. Very Excellent	5D6
7. Superior	6D6
8. Heavy Machinegun	5D10 + 6
9. Heavier Calibre Machinegun	6D10 + 6

(Both 8 and 9 will shoot through a car's engine block)

Bola: Two or three heavy balls attached to a long cord used primarily in South America to *entangle* cattle. **Cost:** \$40.

Damage: 1D4.

Boomerang: The infamous aborigine throwing stick. **Cost:** \$10-\$20 each. **Damage:** 1D6.

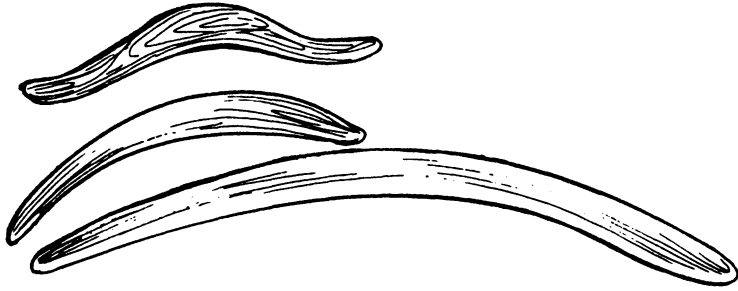

Chakram: A flat steel ring with a sharpened outer edge. **Cost:** \$10 each. **Damage:** 1D4.

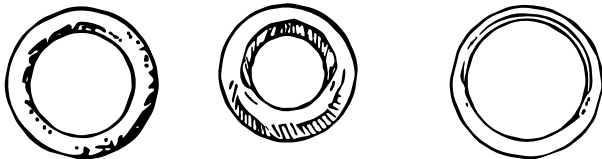

Katar: A Hindu double blade weapon that might be thought of as a small sword, usually about one and a half feet long. **Cost:** \$200. **Damage:** 1D6.

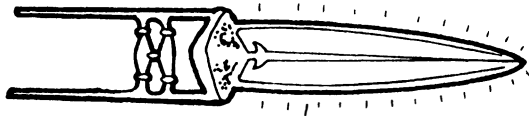

Tiger Claws or Bagh Nakh: A small set of steel claws that fit in one's hand. A weapon favored by assassins in India and the Middle East. Tiger claws were often combined with knives (Bich'Hwa Bagh Nakh). **Claws alone Cost:** \$40. **Damage:** 1D4. **Claws and blades Cost:** \$70 to \$150. **Damage:** 1D6 knife, 1D4 claw.

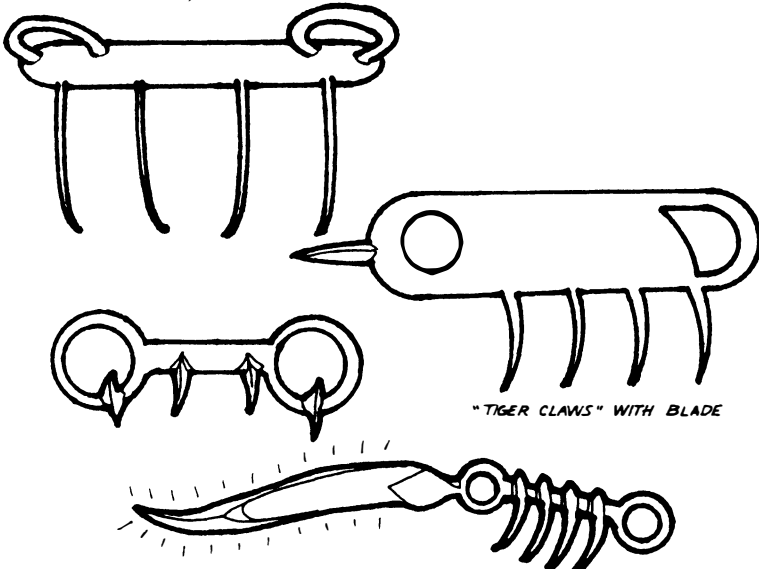

PENETRATION VALUES (other than tissue)

1. Poor: Deflects off bone.
2. Fair: Deflects off bone.
3. Adequate: May lodge in bone.
4. Good: May break bone.
5. Very Good: Shatters bone, wood; goes through cinder block.
6. Excellent: Shatters bone, wood; goes through ½ inch armor plate steel.
7. .50 Calibre: Goes through brick, thin metal.

Note: Numbers in front of cartridge names indicate the **Tissue Damage Rating** from the above table.

PISTOL CARTRIDGES

- (1) **.22 Short:** Very little penetration. Little or no nerve trauma.
- (1) **.22 Long:** Slightly more powerful than the .25 (especially in long barreled guns). Better expansion properties of the bullet results in greater tissue and nerve trauma. Penetration is poor due to the soft mushrooming of the bullet which tends to disintegrate on heavy bone.
- (2-3) **.22 Long:** When used as a *rifle round* the performance of this cartridge increases dramatically.
- (1) **.25 A.C.P.** (Note: A.C.P. stands for Automatic Colt Pistol). Adequate for self-defense if shots are placed in face, head, neck or body areas with no bones to deflect the small projectile; decent penetration.
- (2) **.32 A.C.P.:** Fair to good protection if used in a high capacity automatic. Decent penetration with little or no expansion, as with all jacketed projectiles used in automatics.
- (2) **.32 Long:** (Revolver) Better velocity and penetration. More variety of loads increases its deadliness.
- (3) **.38 Special:** A good self-defense cartridge with good offensive capabilities.
- (4) **.38+ (Power):** Much more power than the standard .38, with better expansion and penetration.
- (5) **.357 Magnum:** An excellent choice for offense and defense. This cartridge produces great amounts of tissue damage, has excellent stopping power, and has great penetration, even when hollow points are used. An excellent hunting round. The weapon itself has been found to be an easier handgun to master than the 9mm, .45 auto, .41 Magnum and the .44 Magnum.
- (5) **.45 A.C.P.:** Introduced in 1911, this shell has proven itself a man-stopper in many countries and conflicts. This cartridge was created to be used against human adversaries and has little or no hunting value. Wide wound channel is caused by this wide, heavy cartridge, resulting in nerve trauma (shock).
- (5) **.45 Long:** Rates the same as the .45 A.C.P., but has better penetration.
- (5) **.41 Magnum:** High velocity, excellent penetration, a very good man-stopper and fine hunting round. Despite this, the cartridge has never been very popular — .357s and .44 Magnums being in much greater demand.
- (5) **.44 Magnum:** An excellent handgun cartridge. It's large, heavy slug does great amounts of damage to tissue. Great penetration and stopping power. Even if a person were

only wounded, the damage inflicted would probably severely hamper any retaliation (this is also true with a .357 and .41 Magnum, but to a lesser degree). A very good hunting round.

- (1) **5.45mm:** Poor stopping power, with poor to good accuracy.
- (2) **7.62mm Nagant:** A service round used by the Soviet Union and in gas-sealed target revolvers.
- (2) **7.63mm Mauser:** Standard Soviet pistol and sub-machinegun round, under the name of 7.62 Tokarev.
- (2) **7.62mm Parabellum:** Used by Central European police and security forces. Not currently in first line service with any army.
- (3) **7.65mm Long:** Unique to French forces. Comparable in power to the contemporary 9mm Browning long cartridge. (The Browning being the world standard for pocket pistols).
- (2) **9mm Short:** Used by many armies, this cartridge may one day replace the venerable .45 Colt in the U.S. Army due to it's better penetration of body armor. Yet, since it does not expand (like in autos), it does not inflict the trauma effect that the fat, stubby .45 round does traveling at slower speeds.
- (3) **9mm Police:** In use with several European police authorities.
- (3) **9mm Makarov:** Not yet made outside the Soviet Union. For use with the Makarov pistol.
- (3) **7.65mm Long:** Unique to French forces. Comparable in power to the contemporary 9mm Browning long cartridge.

RIFLE CARTRIDGES

- (5) **7.62mm Soviet Model 1943:** Standard infantry cartridge of the Soviet Army. It is in widespread use by third world countries.
- (5) **5.56mm:** Similar to the 5.45 Soviet. However, this cartridge is longer and narrower and can not be used in the AK-47.
- (5) **.303 British:** Standard British and Imperial cartridge from 1889 to the 1960's. Best reports indicate that it has never been made in steel-cased form. Excellent range and accuracy.
- (5) **7.92 Mauser:** Probably the most widely distributed military rifle cartridge in history.
- (6) **5.45mm Soviet:** For use with the Soviet AK-47.
- (6) **7.62mm NATO:** Comparable in performance to the 30-06, but in a shorter case. A long-range, sniper-type shell.
- 12 Gauge Shotgun:** Can use a solid slug (6), or can be used with buckshot/scattered shot (5).

SPECIAL CARTRIDGE TYPES

Tracer: This cartridge contains a compound that ignites when the cartridge is fired. This creates a line of light that allows correction of the cartridge's flight path. Cartridge range is reduced by 10-20% compared to a normal cartridge.

Hollow Point: The front end of this cartridge is actually the exposed lead core of the round and does not come to a point. Instead, it has a hollow cavity in it. This causes the round to expand on impact, causing a large wound (+4

tissue damage automatic; +8 tissue damage when used in a revolver). The hollow point is *less* effective against solid/structural objects, ie. doors, brick, etc.

Dum-Dum: Handmade, the tip of the shell is cut to expand and shatter on impact. Less penetration than the hollow point or any other shell. Good for short-range. Can not be used in an automatic since it tends to jam. (25% random roll every 50 rounds).

Full Metal Jacketed: This cartridge will give a better penetration. This is due to the streamlined design and solid construction. It can be used in pistols and revolvers.

Armor Piercing/Teflon (KTW Rounds): This cartridge is not available to the general public, as most people have no reason for using an armor piercing round. It is mostly used by the military and police.

Exploding Shells: This shell can only be used in pistols. It can not be used in rifles at any time. This shell is constructed with a small explosive charge encased in the tip, which explodes on contact with the target. However, it is also an unreliable round. There is a 35% chance per shell that it will not explode. The Damage Bonus for this shell is: For low calibre, +6 damage; Medium calibre, +10; and for large calibre, +15 damage.

ABBREVIATIONS AND TERMS

Cartridge: Type of bullet; ammunition.

Magazine: Compartment which holds ammunition and is directly inserted into the weapon.

Rounds: The number of cartridges/ bullets fired; ie., 7 rounds=7 bullets fired, 13 rounds=13 bullets fired, etc.

Feed: Method by which the cartridge enters the weapon.

Weight: gm = grams, kg = kilograms.

Length: mm = millimeters, m = meters.

Barrel Length: This is only the barrel's length; the overall length, when known, is listed in parenthesis after the barrel length.

Muzzle Velocity: m/s = meters per second; this indicates the speed at which the cartridge is traveling when it leaves the muzzle of the weapon.

Approx. Effective Range: This is the generally accepted, *maximum* range in which this weapon operates most effectively/accurately.

Bolt-Action: Used mainly in older rifles. By pulling back the bolt a spent shell is ejected from the breech. A spring-loaded mechanism then snaps the bolt forward, closing the breech, and a fresh shell is moved into firing position.

Clips: Metal grips which hold the cartridge by the rim or base, which is then inserted into the magazine, forming part of the magazine mechanism.

Calibre: The internal diameter of a weapon's barrel. The American and British usage of calibre is expressed in thousandths of an inch, ie. .357, .45, etc. Others are expressed in millimeters, ie. 9mm, 7.65mm, etc.

F.N.: A reference to the weapons manufacturer: Fabrique Nationale d'Armes de Guerre of Belgium.

Metric Conversion Chart

This chart can be used to convert the metric measurements used in the weapon stats into feet.

30m = 100ft

40m = 135ft

50m = 165ft

100m = 330ft

200m = 660ft

400m = 1320ft

500m = 1650ft

600m = 1968ft

1000m = 3380ft

1400m = 4620ft

REVOLVERS AUTOMATIC PISTOLS

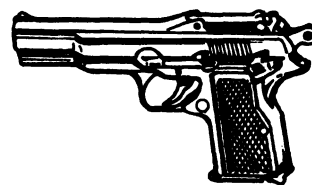

Browning GP 35

Country: Belgium, **Cartridge:** 9mm, **Feed:** 13 round mag., **Weight:** 990gms, **Barrel Length:** 118mm, **Muzzle Velocity:** 350m/s, **Approx. Effective Range:** 135ft (40m), **Damage:** 2D6, **Cost:** \$590.00.



7.65mm 140 Double-Action FN

Country: Belgium, **Cartridge:** 9mm short or 7.65mm, **Feed:** (9mm short) 13 round box mag., **Weight:** 640gms, **Barrel Length:** 173mm, **Muzzle Velocity:** (9mm) 280m/s (7.65mm) 295m/s, **Approx. Effective Range:** 165ft (50m), **Damage:** 2D6, **Cost:** \$370.00.



Barracuda FN Revolver

Country: Belgium, **Cartridge:** .357 Magnum, .38 Special, **Feed:** 6 round cylinder, **Weight:** 1.05kg, **Barrel Length:** 76.2mm, **Muzzle Velocity:** 360m/s, **Approx. Effective Range:** 165ft (50m), **Damage:** 4D6, **Cost:** \$490.00.

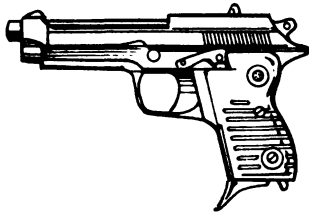

Brigadier

Country: Canada, **Cartridge:** .45, **Feed:** 8 round mag., **Weight:** 1925gms, **Barrel Length:** 140mm, **Muzzle Velocity:** 253m/s, **Approx. Effective Range:** 165ft (50m), **Damage:** 4D6, **Cost:** \$450.00.



.38 Special Mauser Revolver

Country: Germany, Federal Republic, **Cartridge:** .38 Special, **Feed:** 6 chamber cylinder, **Weight:** approx. 600-660gms, **Barrel Length:** 63.5mm (175mm), **Muzzle Velocity:** 360m/s, **Approx. Effective Range:** 165ft (50m), **Damage:** 2D6, **Cost:** \$300.00.



7.65mm Model 61 Skor pion

Country: Czechoslovakia, **Cartridge:** .32 A.C.P. (7.65mm), **Feed:** 10 or 20 round box mag., **Weight:** 1.59kg, **Barrel Length:** 112mm (513mm — butt extended; 269mm — butt retracted), **Muzzle Velocity:** 317m/s — 274m/s with silencer, **Approx. Effective Range:** 165ft (50m), **Damage:** 1D8, **Cost:** \$1300.00.

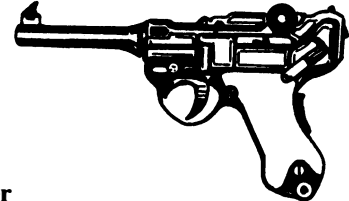

Parabellum Mauser

Country: Germany, Federal Republic, **Cartridge:** 7.65mm, **Feed:** 8 round box mag., **Weight:** 910gms, **Barrel Length:** 150mm, **Muzzle Velocity:** 280m/s, **Approx. Effective Range:** 135ft (40m), **Damage:** 1D8, **Cost:** \$620.00.

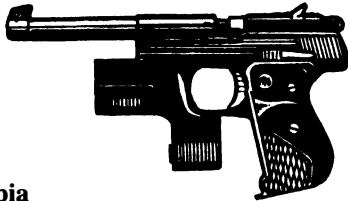

Erma Olympia

Country: Germany, Federal Republic, **Cartridge:** .22, **Feed:** 10 round mag., **Weight:** 1100gms, **Barrel Length:** 200mm, **Muzzle Velocity:** 300m/s, **Approx. Effective Range:** 135ft (40m), **Damage:** 2D6, **Cost:** \$500.00.



9mm Model P5 Walther

Country: Germany, Federal Republic, **Cartridge:** 9mm, **Feed:** 8 round detachable box mag., **Weight:** 795 gms, **Barrel Length:** 90mm, **Muzzle Velocity:** 350 m/s, **Approx. Effective Range:** 165ft (50 m), **Damage:** 2D6, **Cost:** \$925.00.

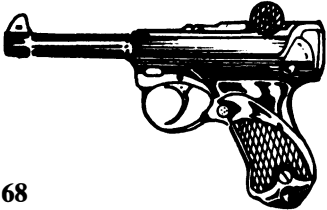

Erma KGP 68

Country: Germany, Federal Republic, **Cartridge:** 7.65mm, **Feed:** 9 round box mag., **Weight:** 638gms, **Barrel Length:** 89mm, **Muzzle Velocity:** 280m/s, **Approx. Effective Range:** 135ft (40m), **Damage:** 2D6, **Cost:** \$350.00.

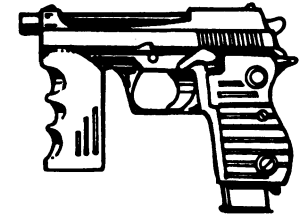

9mm Model 951R Semi P Full Auto Beretta

Country: Italy, **Cartridge:** 9mm Parabellum, **Feed:** 10 round detachable box mag., **Weight:** 1350gms, **Barrel Length:** 125mm, **Muzzle Velocity:** 390m/s, **Approx. Effective Range:** 180ft (55m), **Damage:** 2D6, **Cost:** \$450.00.



7.65mm PP Walther

Country: Germany, Federal Republic, **Cartridge:** 7.65mm, 9mm short, **Feed:** 8 round detachable box mag., **Weight:** 682gms, **Barrel Length:** 99mm, **Muzzle Velocity:** 290m/s, **Approx. Effective Range:** 135ft (40m), **Damage:** 2D6, **Cost:** \$600.00.

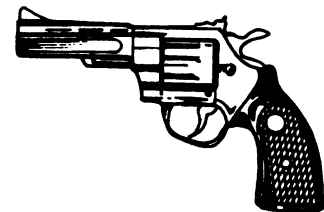

.38 Trident Super 4 Renato Gamba Revolver

Cartridge: .38 Special, **Feed:** 6 chamber cylinder, **Weight:** 720gms, **Barrel Length:** 101mm, **Muzzle Velocity:** 360m/s, **Approx. Effective Range:** 150ft (45m), **Damage:** 2D6 or 3D6 (power), **Cost:** \$250.00.

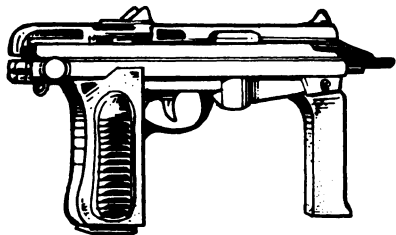

9mm Wz 63 (PM-63) Machine Pistol

Country: Poland, **Cartridge:** 9mm, **Feed:** 25 or 40 round box mag., **Weight:** 1.8kg, **Barrel Length:** 152mm (333mm), **Muzzle Velocity:** 323m/s, **Approx. Effective Range:** 135ft (40m) — Stock extended, **Rate of Fire:** (cyclic) 600 rounds/min., (auto) 75 rounds/min., (single shot) 40 rounds/min., **Damage:** 2D6, **Cost:** \$1200.00.



.38 Special Model 960 Astra Revolver

Country: Spain, **Cartridge:** .38 Special, **Feed:** 6 chamber cylinder, **Weight:** 1.15kgs, **Barrel Length:** 102mm, **Muzzle Velocity:** 265m/s, **Approx. Effective Range:** 165ft (50m), **Damage:** 2D6 or 3D6 (power), **Cost:** \$250.00.



Hammerli Model 208

Country: Switzerland, **Cartridge:** .22, **Feed:** 8 round box mag., **Weight:** 750gms, **Barrel Length:** 125mm, **Muzzle Velocity:** 300m/s, **Approx. Effective Range:** 135ft (40m), **Damage:** 1D6, **Cost:** \$1300.00.



P210-5 P 9mm Model 49 SIG

Country: Switzerland, **Cartridge:** 9mm Parabellum, **Feed:** 8 round box mag., **Weight:** 900gms, **Barrel Length:** 120mm, **Muzzle Velocity:** 335m/s, **Approx. Effective Range:** 165ft (50m), **Damage:** 2D6, **Cost:** \$1500.00.



P230 Sig Sauer

Country: Switzerland, **Cartridge:** 9mm, **Feed:** 8 round box mag., **Weight:** 720gms, **Barrel Length:** 98mm, **Muzzle Velocity:** 320m/s, **Approx. Effective Range:** 165ft (50m), **Damage:** 2D6, **Cost:** \$575.00.

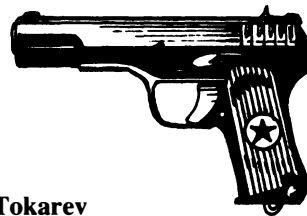

7.62mm TT-33 Tokarev

Country: U.S.S.R. **Cartridge:** 7.62mm, **Feed:** 8 round box mag., **Weight:** .85kgs, **Barrel Length:** 116mm, **Muzzle Velocity:** 420m/s, **Approx. Effective Range:** 180ft (55m), **Damage:** 1D8, **Cost:** \$400.00.

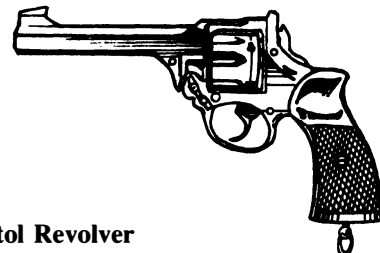

.38 No. 2 Pistol Revolver

Country: United Kingdom, **Cartridge:** .380 SAA Ball Revolver, .38 Smith & Wesson, .38 Webley, **Feed:** 6 chamber cylinder, **Weight:** 767gms, **Barrel Length:** 102mm, **Muzzle Velocity:** 183m/s, **Approx. Effective Range:** 135ft (40m), **Damage:** 3D6, **Cost:** \$225.00.

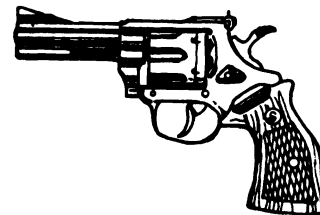

.38 Special

Country: United Kingdom, **Cartridge:** .38 Special, **Feed:** 6 chamber cylinder, **Weight:** 1077gms, **Barrel Lengths:** 70 & 102mm, **Muzzle Velocity:** 360m/s, **Approx. Effective Range:** 165ft (50m), **Damage:** 3D6, **Cost:** \$490.00.

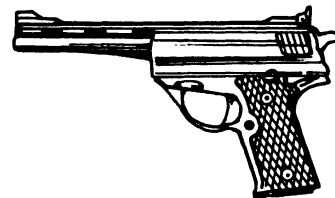

Auto Mag

Country: U.S., **Cartridge:** .44, **Feed:** 8 round mag., **Weight:** 1665gms, **Barrel Length:** 165mm, **Muzzle Velocity:** 245m/s, **Approx. Effective Range:** 165ft (50m), **Damage:** 4D6, **Cost:** \$650.00.

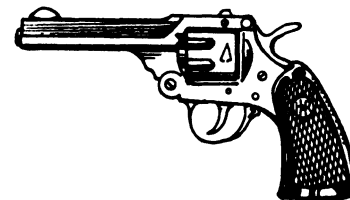

Harrington & Richardson Defender Revolver

Country: U.S., **Feed:** 5 chamber side-loading cylinder, **Weight:** 878gms, **Barrel Length:** 101mm, **Muzzle Velocity:** 245m/s, **Approx. Effective Range:** 135ft (40m), **Damage:** 2D6 or 3D6 (power), **Cost:** \$200.00.

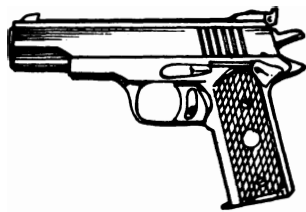

.45 Colt

Country: U.S., **Cartridge:** .45, **Feed:** 6 round detachable box mag., **Weight:** 1190gms, **Barrel Length:** 140mm, **Muzzle Velocity:** 250m/s, **Approx. Effective Range:** 165ft (50m), **Damage:** 4D6, **Cost:** \$400.00.



.45 Model 15 General Officers

Country: U.S., **Cartridge:** .45 A.C.P., **Feed:** 7 round mag., **Weight:** 1088gms, **Barrel Length:** 171mm, **Muzzle Velocity:** 300m/s, **Approx. Effective Range:** 150ft (45m), **Damage:** 4D6, **Cost:** \$370.00.



.38 Service-Six Ruger Revolver

Country: U.S., **Cartridge:** .38 Special, **Feed:** 6 chamber side-loading cylinder, **Weight:** 935gms, **Barrel Length:** 101mm, **Muzzle Velocity:** 350m/s, **Approx. Effective Range:** 165ft (50m), **Damage:** 2D6 or 3D6 (power), **Cost:** \$250.00.

SUB-MACHINEGUNS

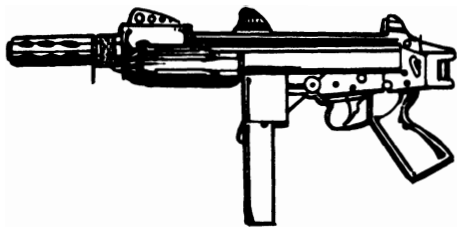

9mm MD1 and MD 1A1 IMBEL

Country: Belgium, **Cartridge:** 9mm Parabellum, **Feed:** 30 round box mag., **Weight:** 3.28kg, **Barrel Length:** 211mm, **Muzzle Velocity:** 400m/s, **Approx. Effective Range:** 615ft (175m), **Damage:** 2D6, **Cost:** \$1250.00.



9mm C1

Country: Canada, **Cartridge:** 9mm Parabellum, **Feed:** 30 round box mag., **Weight:** 2.95kg, **Barrel Length:** 198mm, **Muzzle Velocity:** 366m/s, **Approx. Effective Range:** 606ft (185m), **Damage:** 2D6, **Cost:** \$1200.00.

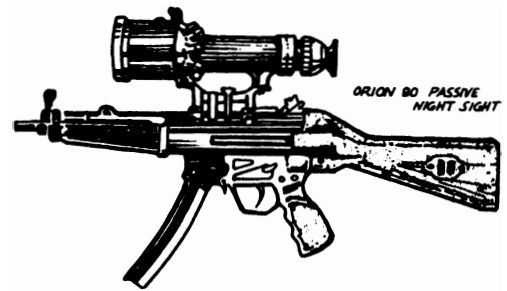

9mm MP5 Heckler & Koch

Country: Germany, Federal Republic, **Cartridge:** 9mm Parabellum, **Feed:** 15 or 30 round box mag., **Weight:** 2.45kg, **Barrel Length:** 225mm, **Muzzle Velocity:** 400m/s, **Approx. Effective Range:** 660ft (200m), **Damage:** 2D6, **Cost:** \$1450.00.



9mm Uzi

Country: Israel, **Cartridge:** 9mm, **Feed:** 25 or 30 round box mag., **Weight:** 3.5kg, **Barrel Length:** 260mm (650mm), **Muzzle Velocity:** 400m/s, **Approx. Effective Range:** 660ft (200m), **Damage:** 2D6, **Cost:** \$1050.00.



9mm Mini Uzi

Country: Israel, **Cartridge:** 9mm Parabellum, **Feed:** 20, 25 or 30 round box mag., **Weight:** 2.70kg, **Barrel Length:** 197mm (600mm), **Muzzle Velocity:** 350m/s, **Approx. Effective Range:** 490ft (150m), **Damage:** 2D6, **Cost:** \$1200.00.

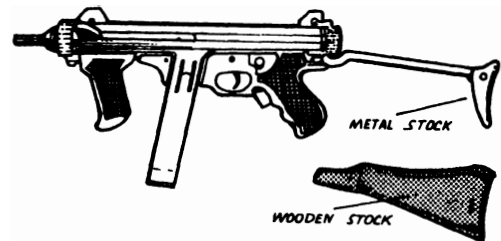

9mm Model 12 Beretta

Country: Italy, **Cartridge:** 9mm Parabellum, **Feed:** 20, 32 or 40 round box mag., **Weight:** 3kg, **Barrel Length:** 200mm (645mm), **Muzzle Velocity:** 381m/s, **Approx. Effective Range:** 660ft (200m), **Rate of Fire:** Cyclic — 550 rounds/min., auto — 120 rounds/min., single shot — 40 rounds/min., **Damage:** 2D6, **Cost:** \$1200.00.

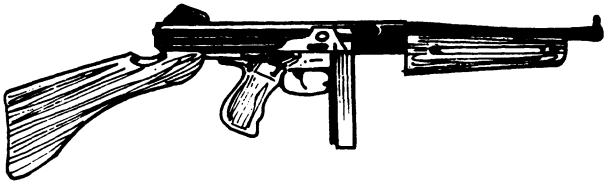

.45 Thompson M1

Country: U.S., **Cartridge:** .45 A.C.P., **Feed:** 20 or 30 round vertical box mag., **Weight:** 4.8kg, **Barrel Length:** 267mm (810mm), **Muzzle Velocity:** 282m/s, **Approx. Effective Range:** 660ft (200m), **Damage:** 4D6, **Cost:** \$600.00.

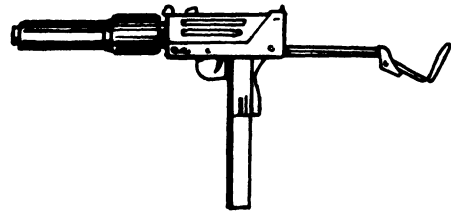

Ingram Model 10

Country: U.S., **Cartridge:** .45 A.C.P., **Feed:** 30 round box mag., **Weight:** 2.84kg, **Barrel Length:** 146mm (548mm), **Muzzle Velocity:** 280m/s, **Approx. Effective Range:** 660ft (200m), **Damage:** 4D6, **Cost:** \$700.00.

RIFLES

7.62mm Model 30-11 Sniping FN Rifle

Country: Belgium, **Cartridge:** 7.62mm NATO, **Feed:** 9 round removeable box mag., **Weight:** 4.85kg, **Barrel Length:** 502mm (1117mm), **Muzzle Velocity:** 850m/s, **Approx. Effective Range:** 2133ft (650m), **Damage:** 5D6, **Cost:** \$1590.00.

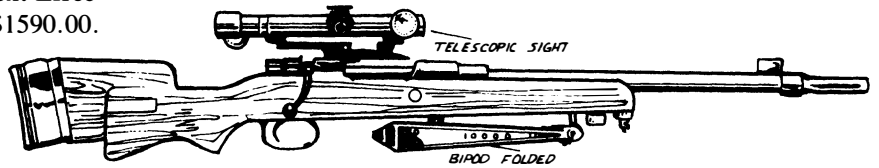

7.62mm C1A1 Modified Rifle

Country: Belgium, **Cartridge:** 7.62mm, **Feed:** 20 round box mag., **Weight:** 4.25kg, **Barrel Length:** 533mm (1136mm), **Muzzle Velocity:** 840m/s, **Approx. Effective Range:** 2133ft (650m), **Damage:** 5D6, **Cost:** \$750.00.

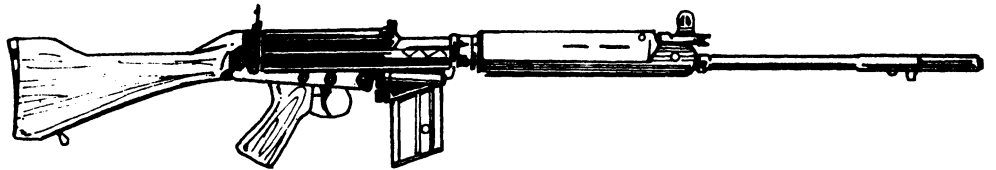

Model 98 Mauser

Country: Germany, Federal Republic, **Cartridge:** 7.62mm, **Feed:** 5 round internal box mag., **Weight:** 3.89kg, **Barrel Length:** 597mm (1103mm), **Muzzle Velocity:** 754m/s, **Approx. Effective Range:** 1968ft (600m), **Damage:** 4D6, **Cost:** \$600.00.

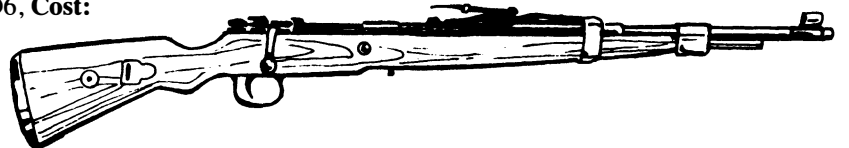

WA 2000 Walther Sniping Rifle

Country: Germany, **Cartridge:** .300 Winchester Magnum, 7.62mm NATO, 7.65 Swiss, **Feed:** 6 round box mag., **Weight:** 6.95kg, **Barrel Length:** 650mm (905mm), **Muzzle Velocity:** 780-800m/s, **Approx. Effective Range:** 1968ft (600m), **Damage:** 5D6, **Cost:** \$1550.00.



7.62mm G3 Heckler& Koch

Country: Germany, Federal Republic, **Cartridge:** 7.62mm, **Feed:** 20 round box mag., **Weight:** 4.4kg, **Barrel Length:** 450mm (1025mm), **Muzzle Velocity:** 780-800m/s, **Approx. Effective Range:** 1320ft (400m), **Rate of Fire:** Cyclic — 500-600 rounds/min., auto — 100 rounds/min. **Damage:** 4D6, **Cost:** \$1700.00.

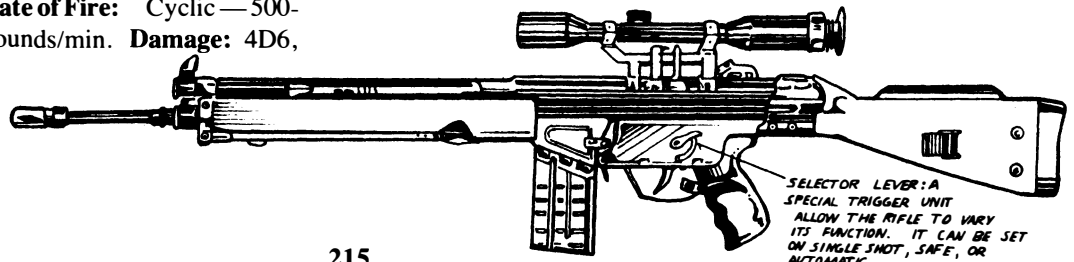

SELECTOR LEVER: A SPECIAL TRIGGER UNIT ALLOW THE RIFLE TO VARY ITS FUNCTION. IT CAN BE SET ON SINGLE SHOT, SAFE, OR AUTOMATIC.

7.62mm SAR Galil Assault Rifle

Country: Israel, **Cartridge:** 7.62mm NATO, **Feed:** 25 round box mag., **Weight:** 3.75kg, **Barrel Length:** 400mm (915mm), **Muzzle Velocity:** 800m/s, **Approx. Effective Range:** 1800ft (550m), **Damage:** 5D6, **Cost:** \$1450.00.

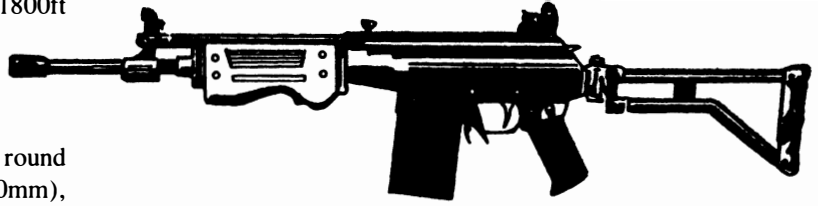

7.62mm Galil Sniping Rifle

Country: Israel, **Cartridge:** 7.62mm NATO, **Feed:** 20 round box mag., **Weight:** 6.4kg, **Barrel Length:** 508mm (840mm), **Muzzle Velocity:** 815m/s, **Approx. Effective Range:** 1650ft (500m), **Damage:** 5D6, **Cost:** \$1400.00.

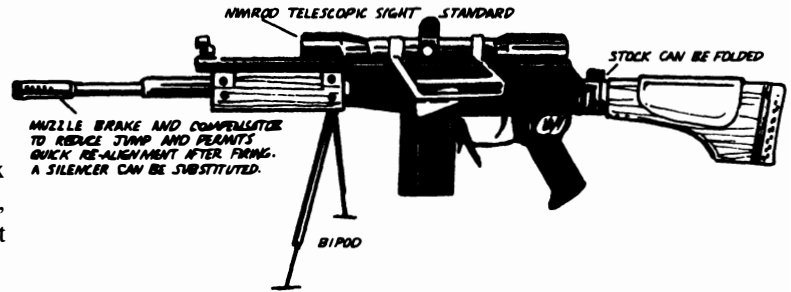

7.62mm AK-47

Country: U.S.S.R., **Cartridge:** 7.62mm, **Feed:** 30 round box mag., **Weight:** 4.3kg, **Barrel Length:** 414mm (869mm), **Muzzle Velocity:** 710m/s, **Approx. Effective Range:** 985ft (300m), **Damage:** 4D6, **Cost:** \$1420.00.

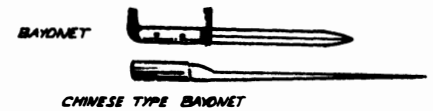

7.62mm Dragunov Sniper (SVD)

Country: U.S.S.R., **Cartridge:** 7.62mm, **Feed:** 20 round box mag., **Weight:** 4.3, **Barrel Length:** 547mm (1225mm), **Muzzle Velocity:** 830m/s, **Approx. Effective Range:** 4265ft (1300m), **Damage:** 4D6, **Cost:** \$1570.00.

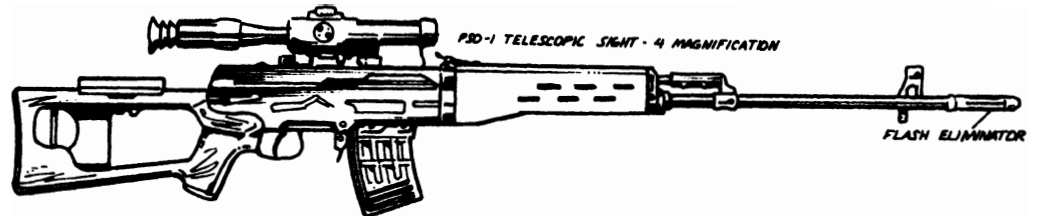

5.56mm AR-180 SCS Sterling-Armalite

Country: United Kingdom, **Cartridge:** 5.56mm, **Feed:** 20, 30 or 40 round box mag., **Weight:** 3.17kg, **Barrel Length:** 464mm (9406mm), **Muzzle Velocity:** 1000m/s, **Approx. Effective Range:** 1509ft (460m), **Damage:** 4D6, **Cost:** \$700.00.

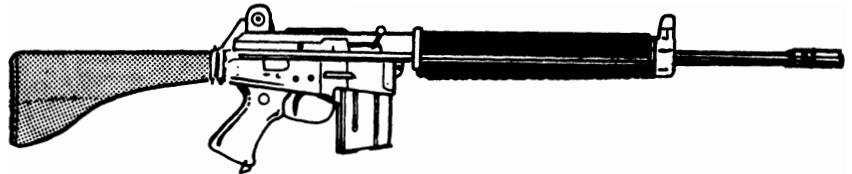

5.56mm M16 & M16A1

Country: U.S., **Cartridge:** 5.56mm, **Feed:** 20 or 30 round box mag., **Weight:** 3.1kg, **Barrel Length:** 508mm (990mm), **Muzzle Velocity:** 1000m/s, **Approx. Effective Range:** 1320ft (400m), **Damage:** 4D6, **Cost:** \$675.00.

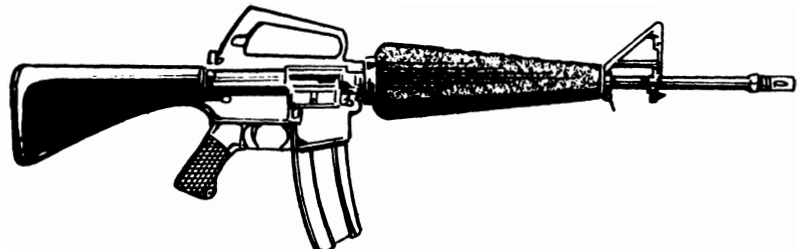

MG Springfield Armory Survival Gun

Country: U.S., **Cartridge:** .22 long rifle rim-fire, **Feed:** single shot, **Weight:** 1.47kg, **Barrel Length:** 457mm (80cm), **Muzzle Velocity:** 300m/s, **Approx. Effective Range:** 1200ft (366m), **Damage:** 2D6, **Cost:** \$700.00.

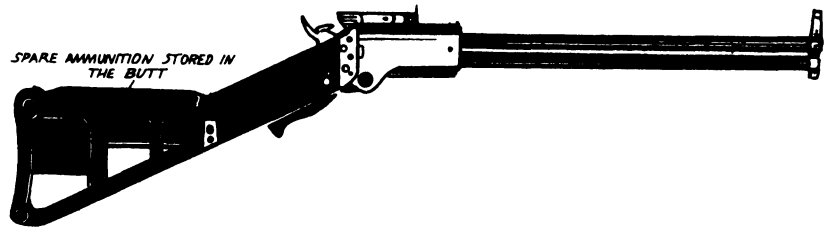

SHOTGUNS

Note: The following stats apply to all shotguns:

Approx. Effective Range: 100ft (30m)

Damage: 4D6 for Buckshot (scatter)
5D6 for solid slug

12 Gauge RS 200 Beretta Shotgun

Country: Italy, **Calibre:** 12 gauge, **Type:** manual repeating, pump action, **Feed:** 5-6 round, pump operated, **Weight:** approx. 3kg, **Barrel Length:** 520mm (1030mm), **Cost:** \$450.00

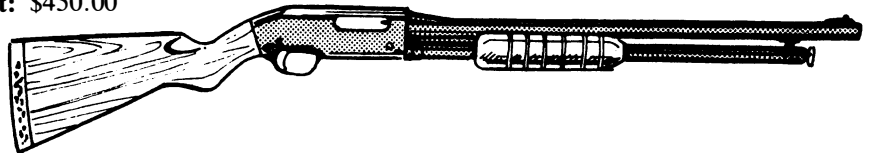

Model 12 SPAS Franchi Shotgun

Country: Italy, **Calibre:** 12 bore, **Type:** gas, semi-auto or hand pump, **Feed:** magazine, **Weight:** 3.2kg, **Barrel Length:** 500mm (900mm), **Cost:** \$550.00.

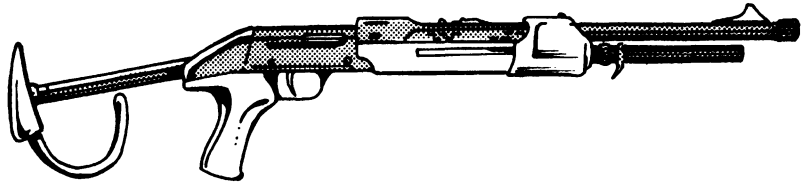

Model 37M Ithaca Shotgun

Country: U.S., **Calibre:** 12 gauge, **Type:** Slide action repeater, **Feed:** 5 or 8 round tubular mag., **Weight:** (20 gauge) 1.58kg, (12 gauge) 2.26kg, **Barrel Length:** 336mm, **Cost:** \$380.00.

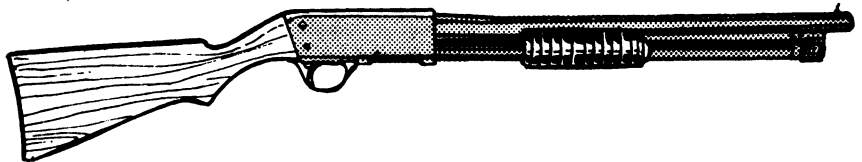

Stakeout Ithaca Shotgun

Country: U.S., **Calibre:** 20 or 12 gauge, **Type:** Slide action repeater, **Feed:** 5 round tubular mag., **Weight:** (20 gauge) 1.58kg, (12 gauge) 2.26kg, **Barrel Length:** 336mm, **Cost:** \$380.00.

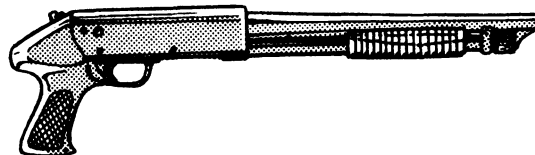

Model 3000 Police Smith & Wesson Shotgun

Country: U.S., **Calibre:** 12 gauge, **Feed:** Single shot, **Weight:** 3.06kg, **Barrel Length:** 458mm (978mm), **Cost:** \$900.00.

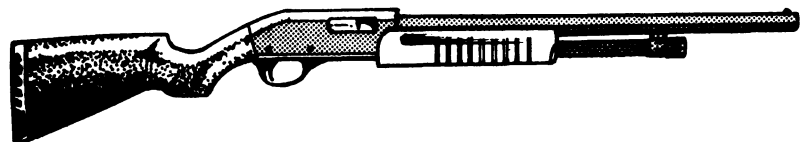

MACHINEGUNS

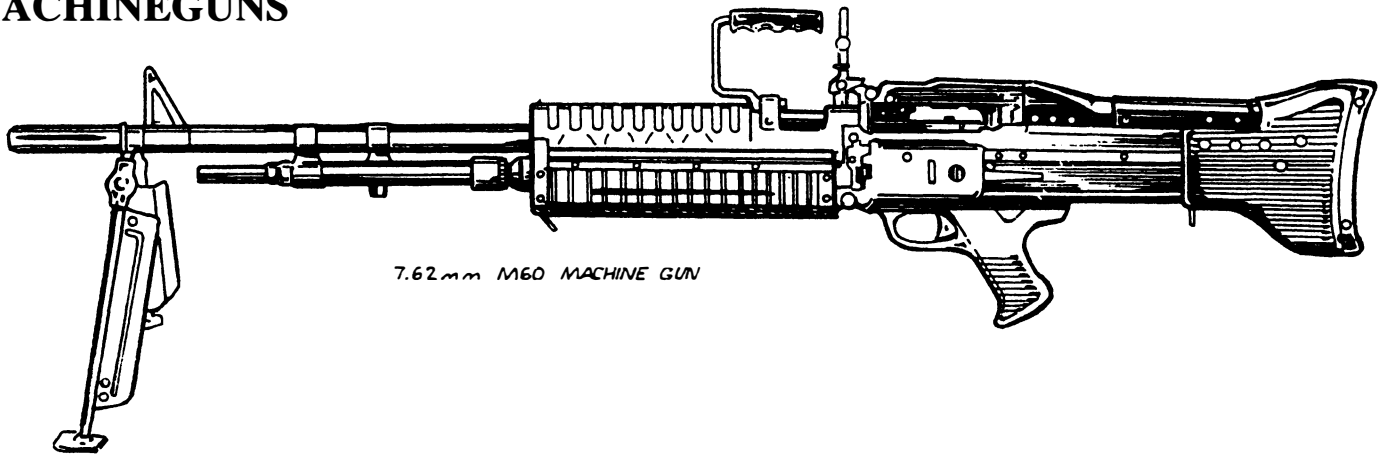

7.62mm M60 MACHINE GUN

.30, 5.62mm and 7.62mm Calibre Light Machineguns

These are the most common kinds of light machineguns found in military forces the world over. **Cartridge:** .30, 5.62mm and 7.62mm in 100, 200 and 250 round belts. **Weight:** 15 to 25lbs. **Effective Range:** 3000ft. **Rate of Fire:** Can empty the weapon in two melee rounds. **Cost:** \$2000.00 and up (mostly illegal). **Damage:** 5D6 per round.

.50 and 14.5mm Heavy Machineguns

These are commonly found mounted on armored military vehicles. As with their lighter cousins, the heavy machineguns are usually found only in military units. Accuracy is poor because they are meant for use against large vehicles or massed soldiers. On the other hand, they will punch right through armor or engine blocks. **Cartridge:** .50 and 14.5mm belts of varying sizes. **Weight:** 30 to 100lbs. **Effective Range:** 3000 ft. **Cost:** \$6000 and up (highly illegal). **Damage:** 7D6 per round.

HEAVY WEAPONS

Rocket Launcher

Called the "Super Bazooka," it is designed as an antitank weapon, but was sometimes used against bunkers. **Weight:** 12lbs (5.4kg), front and rear tubes; 9lbs, rocket. **Length:** 61 inches (1549mm). **Effective Range:** 3600ft (1200m). **Damage:** 1D4 x 100. **Cost:** \$900.00 (mostly illegal). **Blast Radius:** 50ft (15m).

66mm Light Antitank Weapon (LAW)

Light and disposable, this is a favorite weapon for taking out "hardened" positions where the enemy has metal or concrete protection. Against tanks it's not quite as effective, actually killing only about 10% of the time. **Weight:** 5.2lbs (2.6kg). **Size:** 35 inches (889mm), extended. **Rate of Fire:** Single shot and discard. **Effective Range:** 1000ft (325m). **Blast Radius:** 50ft (15m). **Damage:** 1D6 x 100 **Cost:** \$1000.00 (mostly illegal).

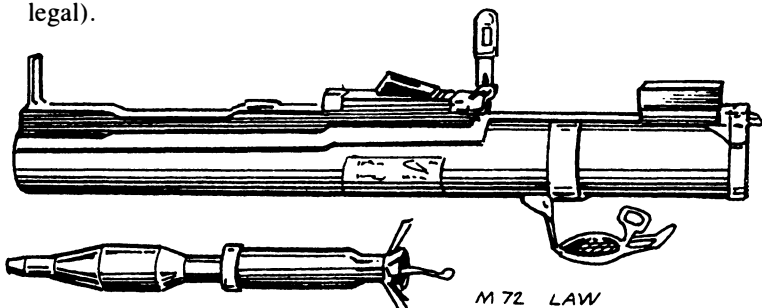

M 72 LAW

90mm Recoilless Rifle

This weapon looks like a bazooka or rocket launcher (see antitank weapons). Fires a single, antitank round. **Weight:** 35lbs (16kg), unloaded. **Feed:** Breech. **Rate of Fire:** (rapid) 10 rounds per minute (max. of 5 rounds) – sustained rate of 1 round per minute. When firing at the rapid rate, a 15 minute cooling period must be observed after every 5 rounds. **Effective Range:** 1200ft (400m). **Blast Radius:** 80ft (24m). **Damage:** 2D4x100. **Cost:** \$1600.00 (highly illegal).

40mm Grenade Launcher Mounted on Rifle

This is basically a M-79 installed under the barrel of a M-16 Assault Rifle. **Weight:** 11lbs (5kg). **Length:** 15.6 inches (361mm). **Feed:** Single shot. **Rate of Fire:** 3-5 rounds per minute. **Effective Range:** 1150ft (350m). **Damage:** 1D4 x 100. **Blast Radius:** 20ft (6.1m), **Cost:** \$1000.00 (highly illegal).

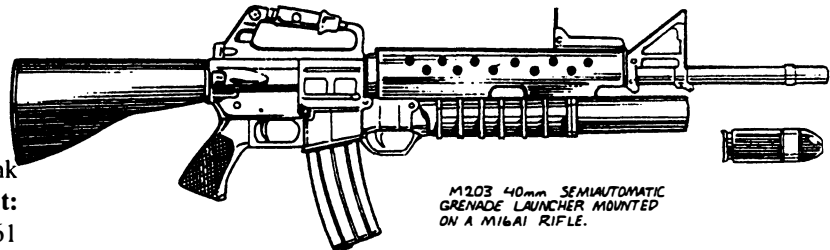

M203 40mm SEMIAUTOMATIC GRENADE LAUNCHER MOUNTED ON A M16A1 RIFLE.

SPECIAL GUNS

Tranquilizer Rifle

This is a rifle designed to fire a tranquilizer dart. Its effective range is about half that of a normal rifle and must be hand loaded, with a maximum capacity of two (both can be fired per melee and require the following melee as a reload time). Saving throw vs. toxin. **Range:** 800ft (240m). **Rate of Fire:** 2 per melee. **Bonus to Strike:** Must have W.P. Rifle. **Damage:** Tranquilizer will render its victim unconscious within 1D4 melees. **Duration:** Effects last 4D4 minutes. **Cost (rifle):** \$1000.00. **Cost (darts):** \$10.00.

Dart Gun

Range: 110ft (33.5m). **Rate of Fire:** 2 per melee. **Bonus to Strike:** Must have a W.P. with Pistol or Revolver. **Damage:** Tranquilizer renders victim unconscious. **Duration:** 4D4 minutes. **Cost (pistol):** \$500.00. **Costs (darts):** \$10.00 each. Savings throw vs. toxin.

Gas Gun (pistol)

The gas gun is a long, wide, tubular barreled handgun that fires a gas canister. **Types of gases:** Tear Gas, Tranquilizer (knockout), Nerve Gas, and Smoke Gas/Screen. **Cost (gun):** \$200.00. **Cost of Tear Gas and Tranquilizer Gas Canisters:** \$50.00. **Cost of Nerve Gas:** \$75.00. **Cost of Smoke:** \$25.00. **Range:** 160ft (48.8m). **Rate of Fire:** 1 per melee. **Bonus to Strike:** Must have a W.P. with Pistol. **Damage:** Varies with the type of gas used.

Stun Gun (blaster)

This pistol fires an energy charge that short circuits the nervous system. Victims are dazed, -10 to strike, parry and dodge, for 2D4 melees.

A successful **saving throw** means that the person has successfully fought off the effect and is unimpaired. Roll to save against each blast that strikes. **Range:** 100ft (30.5m). **Rate of Fire:** 5 per melee. **Bonus to Strike:** Must have a W.P. with Energy Pistol. **Damage:** Special. **Saving Throw:** Save vs toxins. **Energy Capacity:** 10 charges. **Cost (gun):** \$4000.00. **Cost (energy clips):** \$1000.00.

ENERGY WEAPONS

Energy Weapons are highly experimental, rare and terribly expensive. The high cost is due to several reasons: the compact size, the micronized energy clip, the cost of materials and the lack of mass production facilities. At this point each weapon is carefully hand built. Also don't forget that dozens of highly paid scientist have put years of research into the weapons. Consequently, the current cost of these prototypes is in the hundreds of thousands of dollars. If they were mass-produced, the cost would drop to about 10% of their current expense.

Standard Laser Pistol

Range: 600ft (183m)
Damage: 4D6 or 5D6
Attacks Per Melee: Up to four blasts, maximum.
E-Clip Capacity: 10 blasts
Weight: 1.5lbs (.7kg)
Cost: \$300,000. An energy clip costs \$25,000.
Note: A laser pistol with an energy hip-pack (16lbs (7.3kg)); Range: 300ft (91.5m), and limited E-Clip capacity of 20. Costs \$180,000.

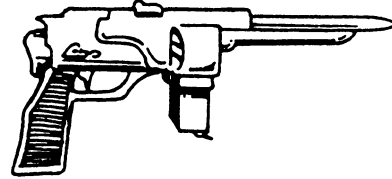

Standard Laser Rifle

Range: 4000ft (1200m)
Damage: 6D6
Attacks Per Melee: Four
E-Clip Capacity: 20 blasts
Weight: 7lbs (2.3kg)
Cost: \$400,000. An energy clip costs \$25,000.

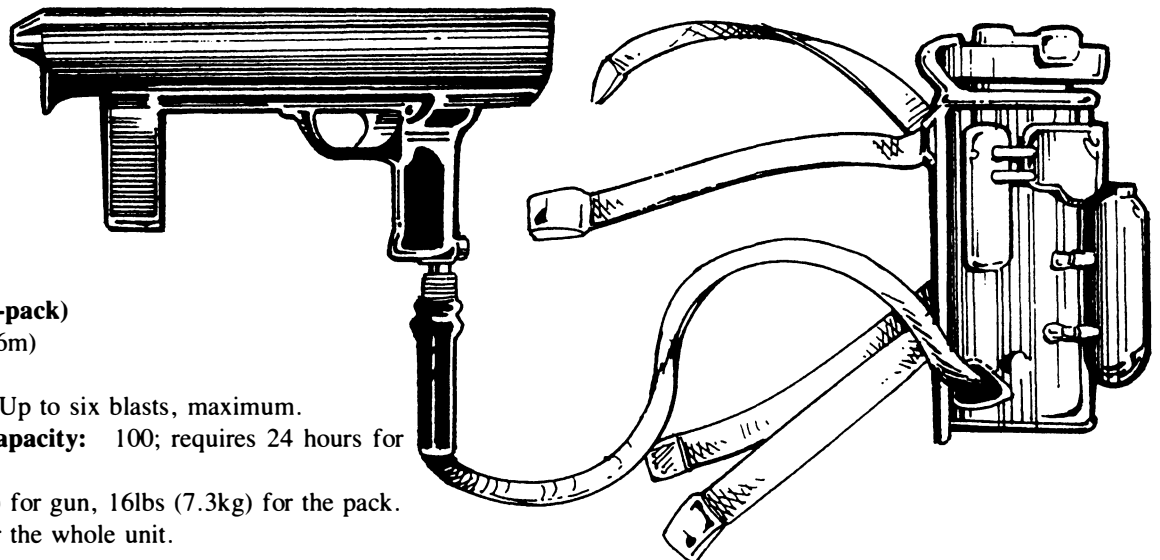
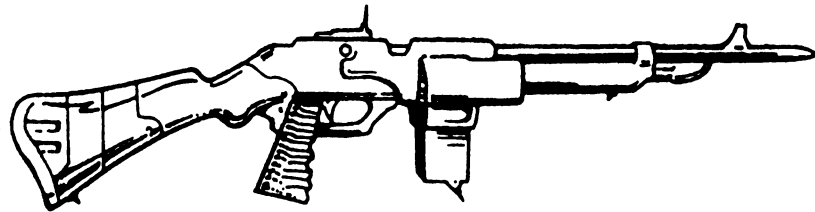

Heavy Laser (with back-pack)

Range: 2000ft (609.6m)
Damage: 6D6 + 10
Attacks Per Melee: Up to six blasts, maximum.
Energy Back-Pack Capacity: 100; requires 24 hours for pack to regenerate.
Weight: 6lbs (2.7kg) for gun, 16lbs (7.3kg) for the pack.
Cost: \$1,000,000 for the whole unit.

Mini-Laser (tool)

Range: 300ft (90m)

Damage: 1D6 or 2D6

Attacks Per Melee: Two

E-Clip Capacity: 20 charges

Weight: 4 ounces (113.4gms)

Cost: \$300,000. An energy clip costs \$10,000.

The mini-laser is a utility tool used by mechanics and communications engineers. This handy, all-purpose tool is slightly longer than a normal writing pen (about 8 inches) and twice as wide. It can be easily carried in pockets, clipped onto utility belts, mini-tool packs or even one's boot.

The laser can fire a short laser beam burst of varying intensity or it can unleash a continual beam. **Short Burst:** Damage: 1D6 (1 energy charge), or 2D6 (2 energy charges). **Continual Beam:** Damage: 1D6 (2 energy charges), or 2D6 (3 energy charges per melee).

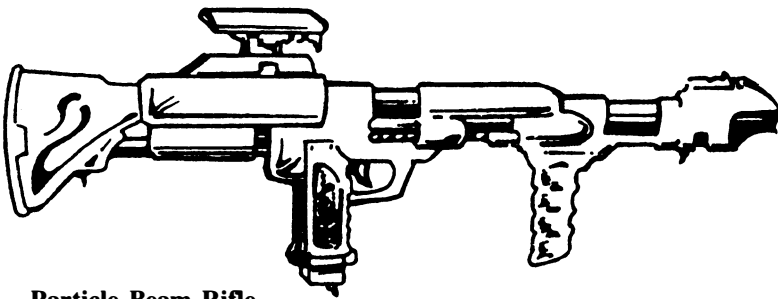

Particle Beam Rifle

Range: 4000ft (1200m)

Damage: 1D6 × 10 or 2D8 × 10

Attacks Per Melee: Two

E-Clip Capacity: 10 blasts

Weight: 12lbs (5.4kg)

Cost: \$800,000. An energy clip costs \$30,000.

The destructive power of this weapon is awesome. The PBR comes equipped with an infrared, telescopic targeting scope.

Damage From A Particle Beam Weapon:

THE FOLLOWING RESTRICTIONS APPLY TO ALL PARTICLE BEAM WEAPONS:

When rolling a twenty-sided die to strike an opponent/target, the normal rules are modified. ONLY a roll of 11 through 20 hits; and even then, a roll of 11-17 is only a nick. A roll of 18, 19 or 20 is a direct hit.

Damage from a nick (a roll to strike of 11-17) indicates that the particle beam merely grazed its target, which probably means part of it is atomized. A so-called "nick" does 10 to 60 points of damage.

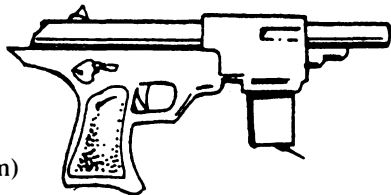

Simple Blaster (Ion)

Range: 400ft (122m)

Damage: 2D6 + 2

Attacks Per Melee: Up to seven blasts, maximum.

E-Clip Capacity: 14 blasts

Weight: 2lbs (.9kg)

Cost: \$200,000. An energy clip costs \$20,000.

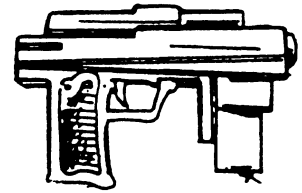

Heavy Ion Blaster

Range: 200ft (61m)

Damage: 4D6

Attacks Per Melee: Up to four blasts, maximum.

E-Clip Capacity: 10 blasts

Weight: 2lbs (.9kg)

Cost: \$250,000. An energy clip costs \$20,000.

INCENDIARY WEAPONS

The use of fire has always been popular in U.S. wars. Clearing enemy bunkers with flamethrowers or incendiary grenades is very effective. **Only 1 shot per Combat Round with incendiaries.**

M-2A1-7 Portable Flamethrower

With a solid stream of fire, a soldier could clear out an entire enemy machinegun nest. In confined spaces (inside a bunker, foxhole or building), everyone in the target area is affected equally. **Damage:** 5D10, plus ignition of all combustible material. **Weight:** 42.5lbs (19kg). **Feed:** Manual. **Effective Range:** 70ft (20m), unthickened; 150ft (45m), thickened. **Cost:** \$400.00 (mostly illegal).

AN-M14 TH3 Incendiary Hand Grenade

This is one of the most dangerous weapons and not just for the enemy. It is difficult or impossible to throw it far enough to avoid getting hit with fragments. **Damage:** up to 12ft from impact – 1D100+20 S.D.C. or 1 M.D.C.; 12-24ft away – 1D100; 24-36ft away – 3D10; 36-120ft away – 1D10. Burns for 10 melee rounds. **Weight:** 24 ounces (.9kg). **Time Delay Fuse:** 4-5 seconds. **Effective Casualty Radius:** Lethal up to 60ft (18m), dangerous to 120ft (36m). **Cost:** \$30.00.

Molotov Cocktail

Range Thrown: 30ft (9m)

Damage: Up to a 12ft area — 3D6

Burns for 4 melee rounds.

Flare Gun

Range: 300ft (91.5m)

Damage: 2D6 per melee ignited (5 melees)

Attacks Per Melee: Two

Weight: 2lbs (.9kg)

Cost: \$200 for the gun only; flares cost \$10 each. Wide availability.

The flare gun has not changed much over the decades and is basically like those we use today. It is generally used as a signal or to light up an area. *Used for Luminescence:* Lights up a 300ft (90m) area for about five melees (75 seconds). It is not intended to be a weapon, thus it is not balanced for aiming; W.P. handgun skill bonuses do NOT apply.

Hand-Held Flares

Range: Hand Held

Damage: One point

Attacks Per Melee: Equal to hand to hand attacks.

Weight: 6 ounces (170gms)

Cost: \$3 each; wide availability.

The hand-held flare is generally used to mark an area or

for signaling. They are similar to those used by present day truck drivers.

Rocket Flare

Range: 300ft (90m) straight up.

Damage: 2D6

Attacks Per Melee: One

Energy Capacity: One

Weight: 5 ounces (141gms)

Cost: \$10 each; wide availability.

This hand-held flare has a disposable, one time, launch mechanism which fires the flare gun. Commonly used for expeditions in the wild. A (minus) -3 to strike penalty applies if used as a weapon.

Rocket Parachute Flare: A signal flare that is fired from a single hand launch tube or flare gun and deploys a parachute-support star. No visible rocket trail is left behind in its launch path to give away the firer's position. Maximum Height: 1000ft (305m), Duration of Illumination: 30 seconds. Power: 200,000 candela. **Cost:** \$10 per flare, plus \$300 for the launcher. Available colors: White, red, green, and yellow.

Distress Signal Kit: Consists of a tube launcher and six red flares. Maximum Height: 900ft (275m), Duration of Illumination: 30 seconds. Power: 10,000 candela, **Cost:** \$120.

Mini Signal Cartridges: A lightweight signal cartridge designed for the military special forces. Fired from a single-handed, lightweight, pen-type launcher. Maximum Height: 320ft (98m), Duration of Illumination: 10 seconds, Power: 150,000 candela. Colors available: Green, red or white. **Cost:** \$250.

GASES: GRENADES & BOMBS

Tear Gas

This extremely potent irritant temporarily impairs vision and respiration, causing eyes to burn and water profusely, skin to burn (a sensation, not in actuality), and making breathing very difficult. **Victims** are -6 to strike, parry, dodge, and lose any chance for initiative. Effects are immediate. **Savings Throw:** None (gas masks counter the gas effectively). **Cost:** \$40.00 each.

Knockout Gas

These are tranquilizers; anesthesia-type mists that will induce drowsiness within 1D4 melees and sleep within 1D4 minutes. **Savings Throw:** If a character makes a successful savings throw vs toxins, his body has successfully fought off the effects of the gas and is unimpaired. However, the player must roll once for every minute (four melees) that the character is exposed to the gas (gas masks counter the gas effectively). **Cost:** \$60.00 each.

Nerve Gas (paralysis)

This is a gas that attacks the person's nervous system; in this case, causing paralysis. Takes effect within 2D4 melees (two minutes). **Savings Throw:** If a character makes a successful savings throw vs toxins, his body will have luckily fought off the effects of the gas (and should get out quick). Roll a saving throw for each minute (four melees) exposed to the gas. Gas masks are useless against most nerve agents; however, Atropine Injectors, an anti-nerve gas agent, will negate the gas's effects.

Cost of Injectors: \$400.00 per dosage. One injector is needed for every ten minutes of exposure and must be administered immediately. **Cost of Gas:** \$120.00 each.

Explosive Grenade

Weight: 10 ounces (283 grams). **Effective Casualty Radius:** 20ft. **Effective Range:** 100ft (30m). **Damage:** 2D4 × 10, (illegal). **Cost:** See Explosives Chart below.

Smoke Grenade

Weight: 10 ounces (283 grams). **Effective Casualty Radius:** 20ft. **Effective Range:** 100ft. **Damage:** None; creates a smoke filled area to provide protective cover (opponents can not see into or through the smoke) or as a signal. Opponents whose vision is obscured by the smoke are -6 to strike. **Colors:** Black, grey, red, yellow. **Cost:** See Below.

Rifle Launcher Grenades

Explosive or smoke grenades fired from an assault rifle. The previous stated damage and effects apply. **Rifle Range:** 1150ft (350m). *Single shot*, **Damage:** 2D4 × 10 to 20ft area.

EXPLOSIVES

Explosives are generally restricted to industrial and military use and difficult to obtain even for heroes and villains. Unless stolen or provided by a sponsoring organization, characters will be forced to purchase them illegally. Prices on the black market are generally quite steep and circumstance or the individual seller may increase the prices listed by 100%.

Black Market Prices

Explosive	Cost	Availability
Dynamite	\$30 per stick	45%
Detonation Caps/Fuses	\$30 each	32%
Plastic Explosive	\$100 per each 2oz	19%
Gelatin Explosive	\$140 per ounce	18%
Liquid Nitroglycerin	\$200 per ounce	20%
Hand Grenades	\$60 each	30%
Smoke Grenades	\$30 each	40%
Rifle Launched Grenades	\$80 each	20%
Mortar Shells	\$100 each	10%

Note: There is always a 20% chance that the item is fake or a dud.

Dynamite is a nitroglycerin based explosive widely used in mining and road construction. It can be detonated with blasting caps, fuses and timing devices. Wick fuses are rarely used today. **Damage:** *One stick:* 1D4 × 10. **Effective Casualty Radius:** 10ft (3m).

Liquid Nitroglycerin is an extremely dangerous, unstable, chemical explosive concentrate. A severe jar, jerk or bump can cause it to detonate; 30% chance. **Damage:** *One ounce is equal to four sticks of dynamite:* 4D4 × 10. **Effective Casualty Radius:** 20ft (6.1m).

Plastic and Gelatin explosives are very localized blast explosives that can be molded and formed like putty. Inert — you

can slam a plastic explosive into a wall and nothing will happen. It can only be activated/ignited by an electrical blasting cap that will pass an electrical charge through it, causing it to explode. Any electrical charge, blast or bolt is also likely to detonate it; 55% chance. **Damage:** 2 ounces is equal to one stick of dynamite: 1D4 × 10. Area effect of blast is exactly where the plastics or gel has been placed; about one foot. Of course, depending on what is being exploded, it could cause much more additional destruction and damage. These are the types of explosives used to open safes and for sabotage. They are not effective area effect weapons.

Homemade Bombs usually incorporate chemicals or dynamite.

MISCELLANEOUS MODERN WEAPONS

Black Jack: A small hand held club, usually handmade, 10 inches long, weighing 2 to 4 pounds. **Cost:** \$20. **Damage:** 1D6.

Brass Knuckles: **Cost:** \$20. **Damage:** 1D6.

Cattle Prod: An electric rod, operated on "C" cell batteries, that emits a 4500 volt shock when it is touched to the skin. 12 or 22 inch lengths. **Cost:** \$20. **Damage:** 1D4.

Itching Powder: Range varies with applications; can be used as a powder, launched in a grenade, housed in a pellet that ruptures on impact, and similar devices. Victims are very uncomfortable, distracted and are -3 on initiative. **Duration:** 1D4 hours or until washed off. Affects only bare skin. **Costs:** Only a couple of bucks per ounce from a novelty shop.

Hair Spray: Can be used to temporarily blind an opponent. Victims are -6 to strike, parry and dodge. **Effective Range:** 3ft (.9m). **Duration:** 1D4 melees. **Cost:** \$3.

Mace: A stinging chemical spray that blinds one's opponent (much better than hair spray). Victims are -6 to strike, parry and dodge. **Effective Range:** 4 to 6ft (1.2 to 1.8m). **Duration:** 4D4 melees. **Cost:** \$16.00, with about 20 sprays before empty.

Modern Crossbow with rifle stock, 150lb draw weight. **Range:** 500ft (150m). **Damage:** 2D6. **Cost:** \$180.

Slap Glove: Six ounces of powdered lead is built into each glove just above the knuckles, padding the wearer and adding weight and strength to the force of one blow. +2 to damage. Available from most security guard suppliers. **Cost:** \$30.

Fiberglass Nightstick: **Cost:** \$10. **Damage:** 1D4.

Steel Rod Encased Nightstick: **Cost:** \$20. **Damage:** 1D6.

S.W.A.T. Entry Tool a.k.a. Hooligan Tool: A long, one inch thick, stress proof bar, heat treated for durability and strength. On one end is a large chisel, spike-like, pry bar. On the opposite end is a claw/chisel point (crowbar-like). Used to pry open security doors and grilles. **Cost:** \$240. **Damage:** 1D8 (either end). Pops normal door locks on a roll to strike of 8-20; pops heavy locks and security door locks on a roll to strike of 12-20.

Modern Knives:

Combat Bush Knife: Heavy-duty, all-purpose survival knife. The best carbon steel 7in blade. **Cost:** \$200. **Damage:** 1D6.

Slimpack Throwing Knife: With a flat, lambskin sheath, this knife is perfect for concealment. Also a perfectly balanced 6in blade. **Cost:** \$50. **Damage:** 1D6.

Belt Throwing Knife Set: 4 ultrathin throwing knives in a single belt sheath designed for an easy, fast draw. **Cost:** \$135. **Damage:** 1D6.

Polycarbonate Knife: This 7in knife (with silk sheath) is guaranteed not to show up on metal detectors. Balanced for throwing, yet with a keen edge for slicing. **Cost:** \$300. **Damage:** 1D6.

Small Boot Knife: For easy concealment. **Cost:** \$20. **Damage:** 1D4.

Bayonet: Attaches to combat rifles. **Cost:** \$140. **Damage:** 1D6.

SLR-60/Spike Launch Rod

Range: 200ft (60m)

Damage: 2D6

Attacks Per Melee: One

Energy Capacity: 30 charges

Weight: 2lbs (.9kg)

Cost: \$1,200

This small, (2ft (.6m)) rod-like device is used for climbing. The SLR-60 can effectively fire a small (6 inch) metal spike up to 60 meters away carrying a high test line along with it for scaling surfaces. It comes equipped with 130 meters of heavy-duty cord, detachable spool, and feeder with digital counter. Additional spikes are available at \$30 a dozen, while additional clip-in, prewound spools of 400ft (130m) line costs \$200 each.

Grappling Hook & Line

Range: 100ft (30.5m)

Damage: 1D4

Attacks Per Melee: Equal to hand to hand attacks.

Weight: 2lbs (.9kg)

Cost: \$150 for hook and 300ft of line.

This is your typical grappling hook and line for scaling surfaces.

FIREARM ACCESSORIES

Ankle Holster: Padded for comfort, with velcro closure. Fits a snub-nosed revolver or any *small* frame automatic. Can be concealed under pant leg. \$34.00

Inside Trousers Holster: Clips on belt or waistband of pants. \$20.00.

Side Holster (fits onto belt). \$50.00.

Belt Slide Holster. \$50.00.

Belt Thumbbreak Holster. \$50.00.

Patrolman, Police-Style Belt and Holster, 24 bullet loops. \$80.00.

Police-style Shoulder Holster. \$80.00.

Military-style Shoulder Holster. \$70.00.

Horizontal Shoulder Holster. \$85.00.

Scoped Shoulder Holster. \$90.00.

Concealed Wallet Holster for *small* automatic weapons; fits easily into back trouser pocket. \$40.00.

Web Belt with holster, ammo pouch (2) and accessory attachment clips (4). \$60.00.

Magazine Clip Pouch: Each of these specially designed ammo pouches is designed for 2 (slimline) or 4 (heavy-duty) ammo clips. Choice of camouflage, green, khaki or black colors. Automatic Pistol: 2 clips, \$10; 4 clips, \$16. Sub-Machinegun: 2 cell — \$12; 4 cell — \$18. 5.56mm Assault Rifle, 20-rnd: 2 clips, \$14; 4 clips, \$20. 5.56mm Assault Rifle, 30-rnd: 2 clips, \$18; 4 clips, \$24. 7.62mm Assault Rifle, 20-rnd: 2 clips, \$18; 4 clips, \$22. 7.62mm Assault Rifle, 30-rnd: 2 clips, \$20; 4 clips, \$26.

Magazine Ammo Bags. \$30.00.

Assault Rifle Case. \$70.00.

Rifle Case. \$60.00.

Sub-Machinegun Case. \$60.00.

Shotgun Bandoleer: Bandoleers are made of brown leather, with a heavy-duty, brass belt buckle. Shotgun version will hold 56 rounds. 40mm grenade version holds 18 rounds. \$24.

Wrist Cartridge Bandoleer: Perfect for concealing 3 extra cartridges. \$15 each.

Metal Ammunition Boxes: These waterproof ammo boxes are designed for easy storage and carrying. .50 caliber size: \$10. .30 caliber size: \$8.

Field Gun Cleaning Kit: A complete cleaning kit contained in its own pouch. \$35.00.

Gun Repair Kit: This is a 4lb gun repair kit. Each tool is fitted into a separate loop and there's plenty of room for spare bolts, screws, springs and cleaning rods. Contained in a 12 inch by 8 inch by 2 inch case. Can be attached to a harness or worn over the shoulder with strap, which is included. \$250.

Magazine Clips: Any weapon, any size, from 7-round pistol to 30-round rifle. \$.89 each.

Web Belt: Classic military belt complete with buckle and pouch fasteners. Choice of camouflage, green or khaki. \$20.

Battle Harness: Combination of suspenders and belt designed for distributing the weight of ammo pouches and accessories. In choice of camouflage, black, grey, brown, cream or khaki. \$120.00.

Battle Pack: Lightweight frame, heavy-duty, water resistant canvas. Multiple interior and exterior compartments. Fasteners for exterior pouches/grenades. Choice of camouflage, green or khaki colors. \$350.00.

Multi-Purpose Pouch: All around, useful utility pouch designed for attachment to web belt or battle harness. \$8.00.

Silencer: A silencer is a barrel-like attachment which fits over the barrel of a gun to muffle the sound of the report. Reduces range by 10%.

Cost by Type: Revolver — \$350
Automatic Pistol — \$500
Bolt Action Rifle — \$600
Automatic Rifle — \$1500
Sub-Machinegun — \$2000

Note: Not available on the commercial market.

Flash Suppressor: Another barrel shaped attachment that can fit over the barrel of a gun or silencer. This instrument masks the guns flash. Usually used for covert night operations. Reduced range by 15%. If both a silencer and flash suppressor are used, range is reduced by 25%.

Cost by Type: Revolver — \$250
Automatic Pistol — \$450
Bolt Action Rifle — \$1200
Sub-Machinegun — \$1600

Note: Not available in the commercial market.

AMMUNITION (Prices Per Box of 100)

.22 caliber	\$12.00
.32 caliber	\$14.00
.38 caliber	\$18.00
.45 A.C.P.	\$28.00
.41 Magnum	\$30.00
.44 Magnum	\$32.00
.357 Magnum	\$28.00
9mm & 7.65mm	\$30.00
5.56mm (rifle)	\$40.00
7.62mm (rifle)	\$48.00
Tracer Cartridge	\$45.00
Hollow Point	add \$12.00
Full Metal Jacketed	add \$25.00
*Teflon (armor piercing, not available to the public)	add \$100.00
*Exploding Shell (not available to the public)	add \$200.00
*Dum Dum (handmade, black market, any caliber)	add \$10.00 to \$30.00.
*40mm Grenade Cartridge	\$700.00 (per 100)

*Ammo with an asterisk are *NOT* available at the neighborhood gun shop, but can be tracked down by the black market and illegal arms dealers. The added price provided is a minimum and can cost two or three times more.

BODY ARMOR

Cost	Ancient Styles	A.R.	S.D.C.	WT.
\$175.00	Padded or Quilt	8	15	66lbs
\$300.00	Soft Leather	9	20	8lbs
\$600.00	Studded leather	12	38	20lbs
\$900.00	Chain Mail	13	44	40lbs
\$1500.00	Scale Mail	15	75	45lbs
\$2000.00	Plate and Mail	15	100	52lbs
\$2800.00	Plate	16	150	58lbs
\$3000.00	Plastic Plated	13	80	28lbs

Note: The costs reflect the rarity of manufacturers/builders and the time involved in the construction. Homemade armor is possible, reduce cost by half. A.R. 2 and S.D.C. by 20%.

Cost	Modern Styles	A.R.	S.D.C.	WT.
Light (half suits)				
\$1200.00	Concealed	10	50	12lbs
\$900.00	Riot Jacket	10	60	12lbs
\$800.00	Vest	10	50	10lbs
\$1100.00	Point Blank Vest	10	70	14lbs
\$1400.00	Hard Armor Vest	12	120	15lbs

Cost	Heavy Armor	A.R.	S.D.C.	WT.
(full suit)				
\$1400.00	Frag. Cape/Vest	13	120	16lbs
\$1600.00	Riot Armor	14	180	17lbs
\$2200.00	Hard Armor	16	260	20lbs
\$2800.00	Class 4 Armor	17	280	20lbs

Note: Half Suits or vest types usually protect the upper body

front, back, side, waist and groin. Concealed are tough thin styles designed to be sewn into clothes or hidden under clothes (shirts, jackets, etc.). The others are all generally bulky or worn atop clothes.

Full suits are all bulky suits worn on top of clothes and provide the greatest protection.

All modern armor is designed for flexibility and mobility and does not interfere with movement, prowl or speed. Many types of armor are constructed of glass-reinforced plastic, chemically strengthened with woven glass fibers and is thicker than metal yet lighter. Other common types use steel or lightweight alloys typically ¼ inch thick. These two types of armor can stop all pistol, revolver, sub-machinegun and low calibre rifle shells. **Hard armor** is composed of ceramics, a form of opaque glass made from pure alumina or boron carbide. They are often combined with steel. Hard armor types provide the most effective protection and can even stop 7.62mm NATO and 5.56mm rifle bullets.

OPTICS

GOGGLES AND BINOCULARS

Binoculars and Telescopic sights magnify an image area through a system of lenses.

<u>Binocular and Telescopic Sights</u>	<u>Cost</u>
Binocular (2000ft), best magnification	\$1600.00
Binocular (1600ft), medium magnification	\$1000.00
Binocular (1600ft), low magnification	\$600.00
Weapon Sight, best magnification	\$800.00
Weapon Sight, medium magnification	\$400.00
Weapon Sight, low magnification	\$230.00

Infrared Optic System: **Range:** 1200ft (360m). This type of optical enhancement device relies on a source of infrared light, usually a pencil-thin beam of light projected from the goggle or binoculars, to illuminate its targets. The narrowness of the beam severely limits the scope of one's view to a small area of about two square meters (7ft). This can make surveying a large area a problem. Another drawback is that the infrared light beam is clearly visible to another infrared optic system, giving away the operator's position. These drawbacks are inherent to ALL infrared systems. **Cost:** about \$1000; fair availability.

<u>Infrared (range: 1200ft)</u>	<u>Cost</u>
Goggles (mercury battery type)	\$550.00
Goggles (new superior type)	\$880.00
Binoculars	\$2100.00
Monocular Eyepiece	\$800.00
Weapon Sight	\$1200.00

Infrared Distancing Binoculars: A high-powered optical enhancement device with infrared adjustments, cross hair indicator lines, and digital readout of estimated distance and rate of travel. **Range:** 2 miles (3km). The I.D. binoculars enjoy extreme popularity among spies, being used for field work and exploration, and are also used by the military. **Cost:** \$6700. Not commercially available.

Ultraviolet Systems: **Range:** 400ft (120m). Enables its wearer to see into the ultraviolet range of light radiation. It's usually integrated into a larger optics package rather than used alone. **Cost:** \$500.

Night Sight: **Range:** 1600ft (480m). A night vision optics system is an image intensifier; meaning that it is a passive system that does not emit any light of its own, but electronically amplifies existing, ambient light to provide a visible picture. **Cost:** \$1400; poor availability.

<u>Night Sights (range: 1600ft)</u>	<u>Cost</u>
Goggles	\$5200.00
Binoculars	\$6400.00
Monocular Eyepiece	\$1900.00
Weapon Sight	\$1800.00
Pocket Night Viewer (800ft range)	\$1500.00
Large Tripod Mount	\$14000.00

Pocket Night Viewer: **Range:** 800ft (240m). This is a mini-night sight, usually a monocular style, easily concealed and portable. **Cost:** \$800; poor availability.

Thermo-Imager: **Range:** 1600ft (480m). Basically an optical heat sensor, it converts the infrared radiation of warm objects into a visible image. This device allow its operator to see in darkness, shadows and through smoke. Battery powered and electrically cooled. A typical running life is 16 hours. **Cost:** about \$1400; poor availability.

<u>Thermo-Imager (range: 1600ft)</u>	<u>Cost</u>
Goggles	\$22,000
Binoculars	\$20,000
Monocular Eyepiece	\$18,000
Weapon Sight	\$18,000

MULTI-OPTICS HELMET

SIDE VIEW

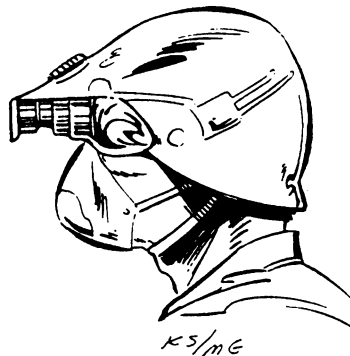

FRONT VIEW



Multi-Optics Helmet (M.O.H.): The multi-optics helmet is a special optical enhancement system built into a protective helmet. It includes the following features:

1. **Targeting Sight:** 1600ft (480m)
2. **Infrared Optics System:** 1600ft (480m)
3. **Telescopic Monocular Lens:** Range: 2 miles (3km)
4. **Thermo-Imager:** Range: 1600ft (480m)

Special Bonus: +1 to strike when the optics and targeting sight are engaged. Note that the thermo-imager is a special, optical, heat sensory unit that allows the infrared radiation of warm objects to be converted into a visible image. Enables the person to see in darkness, shadows and through smoke. **Cost:** \$38,000. Available to high-tech organizations.

Optics Band: The optics band is a headband type optical system most often used in research, micro-repairs and scientific study. Its range is limited as it is designed for close work, not long-distance or combat surveillance. Features include:

1. **Infrared and Ultraviolet Optic System:** **Range:** 200ft (90m) maximum.
2. **Magnification Lens** (to the 400th power): **Range:** 7ft (2m)
3. **Night Sight:** **Range:** 200ft (90m)
4. **Adjustable Color Filters.**
Cost: \$2800.00.

Pocket Range Finder: An optical range finder that is compact and easy to use. Just look through the viewfinder and adjust the focus knob until the image is clear. The range in feet AND meters will appear below the target. **Cost:** \$58.

Illuminating Pelight: Designed for military use as markers for routes and minefields. Emits beta light which emits no heat and gives no infrared emissions. Can be seen from distances of up to 150ft. **Cost:** \$50 each.

COMMUNICATIONS

Communications Equipment: Communications equipment is fairly basic in regards to the character's use and needs. Various surveillance and video systems might be added on, depending on the circumstances and the player's ingenuity.

Field Radio: A back-pack style, radio transmitter and receiver with wide band, long-range capabilities; frequency equalizer, field strength detector and scrambler. **Range:** 60 miles (96km). **Weight:** 16lbs (7kg). **Cost:** \$1400.00; good availability.

Back-Pack Radio: A Japanese updated version of the old PRC-25. Comes with built-in scrambler and up to 1500 channels. Also capable of receiving commercial AM/FM/Television (sound only) and Short-Wave signals. RKO-68. **Range:** 35 miles (56km). **Cost:** \$925.

Belt Radio: A lightweight unit designed to work with the RKO-68. Scrambler equipped, 2 to 3 mile range, up to 10 preset channels. Weighs only 2lbs, complete with pouch and telephone-style handset. RKO-12. **Cost:** \$115.

Headset Receiver: These receiver-only units are easily attached to the helmet. Built-in scrambler and range of 2 miles. **Cost:** \$42.

Hand-Held Communicator: Basically an enhanced walkie-talkie, it is a basic instrument issued to all military personnel and field operatives. **Cost:** Per single unit — \$3200. This is a high-tech item available only to the special branches of the military (espionage) and major scientific organizations/industries. **Weight:** 6 ounces (170grams). **Range:** 3 miles (4.8km).

Ear Mike Radio Receiver and Transmitter: A tough, reliable radio device that plugs into the ear. With the help of a transducer connected to a receiver/transmitter device, and manually activated for speak or listening modes, the user can both listen and speak through the earphones. This is possible because the ear canal captures ingoing and outgoing sound (your voice), as well as incoming sounds. It is so effective that the user can transmit a whisper.

Compatible with any portable, two-way radio equipped with an external speaker/microphone. **Weight:** 6 ounces (170 grams). Power source is one AA 1.5 volt battery. **Range:** 1 mile. **Cost:** \$500.

SURVEILLANCE EQUIPMENT

Keyhole or Tube Microphones: A microphone (mic.) with a long, hollow tube which can be flexible or stiff, allowing it to be placed in cracks, mounted in walls, or placed in similar, small, "keyhole"-type crevices. Picks up sounds up to 34ft (10m) away and transmits up to 1000ft (300m). **Cost:** \$170; fair availability.

Contact Microphone: Translates vibrations into sound, but requires a sounding board, such as a wall, windows, large object, etc. Can be as small as a tie tack. Picks up sounds up to 10 meters away and transmits up to 1000ft (300m) away. **Cost:** \$170, fair availability.

Commercial Wireless Microphone: (entertainment). **Cost:** \$50-100.

Compact Commercial Wireless Microphone: (size of a pack of cigarettes). **Cost:** \$70-\$150.

Wireless Microphone: This compact mic. is about the size and thickness of a box of matches. It can pick up sounds up to 14ft away and broadcast up to 300ft away. **Cost:** \$500; poor availability.

Tracer Bug: This is a tiny device, about the size of a checker, which has a sticky or magnetic side that can be attached to a vehicle or slipped into a person's pocket, back pack, briefcase, etc. It can transmit a signal that can be followed up to 8 miles (12km) away. Battery powered, it has a limited life of 72 hours of constant transmission. **Cost:** \$140; fair availability.

Bumper Beeper: Attaches to automobile bumper via magnetized clip. The antenna can be permanently mounted or detachable. Transmits a signal that can be followed up to five miles away (battery powered). The receiver picks up and can locate the beeper by the intensity/strength of the signal. **Cost:** (includes receiver) \$1100.00.

Listening (bugging) Device: Average range: 600ft.

Tie Clasp: Microphone; **Cost:** \$15.00.

Electret Condenser Lavalier Mic.: Can be hung around neck or attached to cloth. Battery operated or plugged in. **Cost:** \$50.

Broadcast Quality Tie Tack: **Cost:** \$160.00.

Special Bugs: These come in a variety of sizes, from postage stamp to martini-olive type, complete with mic., transmitter and amplifier. **Average Range:** 60ft. **Cost:** \$400.

Room Bug: This bug taps into the wall current (needs capacitor). **Range:** 1200ft. **Cost:** \$100 (homemade) or police version — \$500.

Transmitters (typical) — \$200.

Transmitters (quality crystal) — \$500.

Low-Frequency Converter: \$500.

Frequency Equalizer (controls cutoff of certain frequencies and boosts others). **Cost:** \$190.

Test Transmitter: **Cost:** \$65.

Additional Transducer: **Cost:** \$75.

Telephone Induction Unit: **Cost:** \$65.

Sound Amplifier: **Cost:** \$50.

Sound Amplifier (high quality): **Cost:** \$250.

Telephone Bugs

Drop in Cartridge: Battery powered; fits in the telephone receiver. **Cost:** \$320.

Room Bug Mini-Transmitter: Looks like a telephone jack; battery operated. **Cost:** \$240.

Telephone Line Transmitter: Taps right into telephone line and power (needs no batteries, will run indefinitely). A little larger box than the mini-transmitter. **Cost:** \$250.

Bug Detectors

Field Strength Meter: Picks up radio signals and registers them. **Cost:** \$350.

Broadband Receiver: Causes a feedback and makes a howl when near a transmitter. **Cost:** \$425.

Pocket Vibration Detector: **Cost:** \$600.

Pocket Scrambler: The scrambler will distort or "scramble" outgoing radio signals, preventing interception and interpretation by the enemy. **Cost:** \$1300; poor availability.

Portable Telephone Scrambler: Converts normal speech into unintelligible gibberish over the telephone line and converts the gibberish into clear speech. 25 different scrambling codes. Fully transistorized and can be used on any conventional phone. **Cost:** \$1400. Comes with an impact resistant carrying case.

OTHER SURVEILLANCE DEVICES

Video Briefcase: An ordinary looking briefcase with a video recording surveillance system built into it. The tiny pinhole lens is nearly invisible (18% chance of it being noticed). Three hour film capacity. Reinforced, impact cushioned case with a back-up, mini-cassette tape recorder. **Cost:** \$3400.

Video Wall Mount: This small, remote video camera is only about the size of a man's palm (5 inches in diameter), thus it is easily concealed. The camera is backed with a powerful suction device that will adhere to any smooth surface, whether it be a wall, table, appliance, vehicle and so on. The video wall mount can broadcast continually for 72 hours, or by remote or preprogrammed, regulated intervals. The lens has limited mobility, able to rotate in about a 90 degree radius. Its audio capacity has twice the duration of its video transmission and is able to pick up sounds up to twenty feet (6m) away with crystal clarity. The monitor can be the mini-hand-held screen or any variety of larger or multi-unit monitors. **Cost:** \$3200. Not available through the conventional market, but a hot commodity on the black market. Hand-held monitor costs \$450.

Mini-Telephoto Document Camera: A tiny, easy to conceal camera, only a little bigger than a disposable lighter. **Cost:** \$350.

Note: Conventional video systems, cameras, lenses, optics and audio recorders, are also effective tools for surveillance.

SENSORY EQUIPMENT

Dosimeter: Picks up and measures radiation levels. **Range:** 20ft (6.1m). Hand-held; **Weight:** 1lb (.5kg). **Cost:** \$200. Wide availability.

Ground Sensor System: Uses seismic and laser sensors to detect vehicles/men, their direction and their numbers. A good communications engineer can make such projections with 75% accuracy. The control unit, with digital display, computer mount and monitor, is the center of this sensor web or fence. Up to 22 transmitter/receiver, sensor units can be linked to the control unit. Range between transmitters is 800ft

(240m) and can register activity up to 10 miles (16km) away. **Cost:** \$48,500. Poor availability; generally limited to the military and scientific research.

Heat: Special sensors pick-up and measure heat emanations. Can monitor temperature, or made directional to pinpoint a specific heat point/target. **Range:** 250ft (76m); field of detection is 25ft (7.6m). Portable/hand held. **Weight:** 8lbs (3.6kg). **Cost:** \$1200.

Microwave Fence: Transmitter and receiver sensor posts emit an invisible, microwave curtain or fence that will light up and send a signal to the control unit when an intruder breaches its curtain. Range between transmitter posts is 500ft (150m). Posts are 7ft (2m) high. Can effectively cover a 14 mile (22km) area. **Cost:** \$60,000. Poor availability; primarily used for military purposes.

Motion: Detects movement and pinpoints location. Requires sensor placement and monitor screen. **Range:** 60ft (27.4m). Portable; **Total Weight:** 15lbs (6.8kg). **Cost:** \$400. Fair availability.

Motion Detector Signaler: This device is virtually identical in purpose and use as the ultraviolet signaler, except that it does not emit any vibrations in the air. **Cost:** \$1000; poor availability.

Mini-Radar/Sonar: Requires radar signal unit and monitor. Trained operators (sensory equipment skill) can positively identify readings/objects, pinpoint location and estimate rate of travel and direction at 65% proficiency. **Range:** 5 miles (8km). Portable; **Total Weight:** 18lbs (8.2kg). **Cost:** \$22,500. Fair availability.

Standard Radar/Sonar Unit (large): **Range:** 100 miles (160km). **Weight:** 260lbs (117kg). **Cost:** \$26,000.

Ultraviolet Signaler: The signaler is a small strip of ultraviolet sensors and another transmitter strip that can be adhered to a doorway, walls and so on, to create a beam of invisible light, blocking that area. When the beam is broken by an intruder or vehicle, etc., it will send a silent signal to a monitoring device and/or trigger a video unit. **Cost:** \$900; fair availability.

SPECIAL EQUIPMENT

Portable Laboratory: This is another impressive portable unit that can perform several functions.

1. **Microscope** in a specially padded housing.
2. **One dozen specimen slides** and another dozen specimen trays for storage and transportation of item(s) for further analysis. A variety of vials, jars and test tubes.
3. **An incubation chamber** that is about the size of a VCR (1½ft × 1ft × 8in. deep).
4. **Four burners.**
5. **Instrument tray** with a variety of common tools, such as scalpels, tweezers, pins, tape, needles, calculator, etc.
6. **A refrigeration chamber** which is about half the size of the incubation chamber.
7. **An isolation chamber.** A special, airtight, sealable compartment about the size of the incubation chamber.
8. **A chemical cabinet** which holds several dozen chemicals commonly needed in the analysis of chemical structures.
9. **Centrifuge Device.**
10. **Dosimeter.**

11. **Tape recorder.**
 12. **Mini-computer.**
 13. **Mini-still camera,** 35mm, 32 photo capacity.
 14. **Toxic analyzer** identical to the one used in the "portable bio-scan".
- Cost:** \$42,000; poor availability. **Weight** of the whole unit is 58lbs (26kg).

Portable Scan Dihilator: The portable scan dihilator is a uniquely comprehensive sensory device with FULL scanning capabilities.

1. **Radar/Sonar:** **Range:** Limited to a 5 mile area. A trained operator (sensory equipment skill) can positively identify readings as specific objects or vehicles, pinpoint location, and estimate rate of travel and direction at 65% proficiency.
2. **Sensors** include dosimeter, radar detector, heat, infrared, ultraviolet, microwave, and energy sensitive instruments; all of which identify, locate source, and record.
3. **Long-range, wide band radio** with scrambler. **Range:** 40 mile radius.
4. **Detachable short- range (hand-held) communicator.** **Range:** 3 miles.
5. **Video camera** (mini) with both wide and narrow angle lenses. Audio-visual recorder using metal discs with digital meter; lens filters, telescopic lens (480m) and tripod included. Capable of radio telemetry when boosted by long-range radio.

Cost is about \$50,000. Poor availability; usually limited to scientific research and the military.

DETECTION EQUIPMENT

Amplified Sound Detector: A unique device designed for professional hunters to hear approaching game. It is also used by the security industry. It is a two-piece unit, consisting of headphones and sound detector, which at first glance, resembles a very large flashlight. Utilizes a built-in, 3½ inch parabolic dish for sound mirror effect. Triples the normal human range of hearing. Weighs about 2lbs (.9kg). **Cost:** \$160.

Bug Detector: A small hand-held device that picks up radio signals from listening devices (bugs). **Cost:** \$350.

Letter Bomb Detector: An electronic instrument that examines letters in minutes, with an audio alarm that sounds when electrically conductive material is detected. **Cost:** \$700.

Portable Explosives Detector: Responds to vapor from explosives, such as dynamite, gelignite, T.N.T. and others. An alarm lamp lights up when an explosive is detected. **Cost:** \$1900. **Range:** 3½ft.

Radar Signal Detector (military): This is a mini-radar receiver that can fit in one hand. Small, lightweight, easy to conceal. Recently developed for the U.S. Army. **Cost:** \$3000. **Range:** 80ft (effective range), 4 miles maximum.

Commercial Radar Detector: Also known as the "Fuzz Buster" because of its use in detecting police radar scans. **Cost:** \$120.

EMOTION AND STRESS DETECTORS

Psychological Stress Evaluator: This instrument is used by law enforcement agencies, private investigators, some private corporations, clinics and law firms. It functions like a poly-

graph machine, but measures and records stress and anxiety without attaching sensors to the subject. It does this by specifically monitoring the voice quality of its subject. A tape recorder is also a part of the device. **Cost:** \$4000.

Polygraph Stress Machine: Sensors are attached to the skin which monitor and record glandular changes (including sweat) in the skin. **Cost:** \$2400.

Polygraph Stress Monitor: (superior quality) Sensors are attached to the skin and body which usually record breathing, heart beat/rate, blood pressure, and skin resistance (as described previously). All three functions are fed into a chart recorder, with three pens to mark the results. **Cost:** \$4500.

PHOTOGRAPHIC EQUIPMENT/FILM/VIDEO AND OTHER OPTICAL EQUIPMENT

35mm Camera	\$250.00
Extra Lenses:	
28mm, F2.8	\$80.00
135mm, F3.5	\$80.00
Flash (average)	\$50.00
35mm Film: Black & White, 36 exposure	\$2.50
Color, 36 exposure	\$4.50
Super 8mm, sound movie camera	\$525.00
Super 8mm film; approx. 15 min. running time	\$8.00
Slide Projector	\$150.00
Projection Screen	\$50.00
VHS Video Recorder	\$500.00
Beta Video Recorder	\$400.00
Video Camera with Tripod	\$2000.00
Full Video Studio with editing, dubbing, optical enhancements, and full film capabilities.	\$180,000 (basic system)
Color Camera with Mike	\$700.00
Videotape Cassette	\$10.00
Telescope, zoom 15-60X power; 1000-4000mm when attached to a 35mm camera	\$190.00
35mm Camera Adapter	\$30.00

UNDERWATER EQUIPMENT

Mask, Snorkel and Fin Package: **Cost:** \$110.

S.C.U.B.A. Package: 80K cylinder with boot, datacom double console (PSI Depth), regulator, wet suit, pack and power. Oxygen capacity: 90 minutes. **Cost:** \$820.

Compact S.C.U.B.A.: A one unit, 2 cubic foot capacity cylinder (air tank) with regulator mounted on top and belt holder. Overall length: 17 inches × 2½ inches wide. Great for short dives or emergency air supply. Oxygen capacity is 15 minutes. **Cost:** \$155.

Mini S.C.U.B.A.: (Not commercially available; espionage). This is a tiny air tank and regulator measuring 5 × 2½ inches. Oxygen capacity is a mere FOUR minutes. **Cost:** \$300.

Diver's Watch: Multifunctional digital and analog (hands) display, alarm, two time zones, timer, rotating bezel, sweep second hand. **Cost:** \$300.

Dive Flasher: A waterproof beacon or rescue marker. Waterproof up to 150ft. Measures 5 × 1½ inches; operates on one "C" battery. **Cost:** \$30.

Mini Flashlight: Overall length is 4¾ × ¾ inches; uses 2 "AA" batteries. Features pocket clip, magnetic butt, and screw down

CONTAINERS

Saddlebag (horse)	\$100.00
Small Pocket Purse	\$5.00
Belt Purse (attaches to belt)	\$10.00
Shoulder Purse — Small	\$20.00
Shoulder Purse — Large	\$35.00
Small Sack	\$6.00
Large Sack	\$15.00
Knapsack	\$25.00
Back Pack	\$60.00
Cloth Handle Bag	\$10.00
Tobacco Pouch	\$20.00
Waterskin — 2 pints	\$20.00
Waterskin — ½ gallon	\$30.00
Waterskin — 1 gallon	\$50.00
Cask, Wooden — 4 gallons	\$30.00
Cask, Wooden — 10 gallons	\$40.00
Cask, Wooden — 25 gallons	\$60.00
Vial, Glass — 2 ounce	\$4.00
Jar, Glass — 1 pint	\$4.00
Jar — 2 pints	\$2.00
Jar — 4 pints	\$4.00
Jar — 1 gallon	\$10.00
Jug — ½ gallon	\$20.00
Jug — 1 gallon	\$35.00
Jug — 5 gallons	\$60.00
Small Wood Crate	\$20.00
Medium Wood Crate	\$30.00
Large Wood Crate	\$50.00
Trunk, Small Wood — 25lbs — 30 S.D.C.	\$80.00
Trunk, Large Wood — 50lbs — 70 S.D.C.	\$200.00
Small Metal Security Box — 5lb — 30 S.D.C.	\$40.00
Large Metal Security Box — 15lbs — 90 S.D.C.	\$80.00
Metal Trunk, Small — 35lbs — 100 S.D.C.	\$250.00
Metal Trunk, Large — 80lbs — 200 S.D.C.	\$500.00
Small Safe — 50lbs — 350 S.D.C.	\$900.00
Large Safe — 300lbs — 1000 S.D.C.	\$2000.00

MISCELLANEOUS EQUIPMENT

Bullet Resistant Attache Case: A.R.: 15, S.D.C.: 140.
Cost: \$440.00.

Courier Briefcase: A.R.: 11, S.D.C.: 90. Cost: \$225.00.

Acoustic Noise Generator: Muffles conversations, distorts bugging systems by 30%. Cost: \$900.00.

Camouflage Paint Kit: 4 spray cans plus 6 stencils allow for easy camouflaging of vehicles, bunkers, and any field equipment. One kit will cover approximately 100 square feet of surface. Available in jungle, forest or arctic. Cost: \$35.00.

Camouflage Tape: The ever popular duct tape. Comes in rolls 26ft long and two inches wide. Available in jungle, forest or desert camouflage, or in olive drab. Cost: \$6.00 per roll.

Camouflage Compact: A one-man kit for camouflage or night operations. Includes enough face and hand paint for 6 applications. Mirror, brush and disposable cleaning pads are also included in a neat, black case, 4 inches in diameter and ½ inch high. Cost: \$18.00 each.

Climbing Kit: A complete set of equipment for rappelling, rock scaling or climbing. Includes 3,600ft reels of 4500 test

rope (each reel weighs 40lbs). An adjustable harness with clamps, 6 pairs of canvas climbing gloves. 48 clamps, 48 fasteners, 48 pitons, 3 hammers, 2 grappling hooks, and one pulley. Weight with shipping crate is 190lbs. Cost: \$1100.00.

Ear Protector Headphones: The answer to the Demo expert's and grenadier's dreams. The same model is used by airport workers to preserve hearing in noisy environments. Cost: \$35.00.

Electro-Adhesive Pad: This is a hand-held device that will adhere strongly to any metal surface by means of passing a small current through two metal electrodes. These pads are commonly used by astronaut's and can be used in astronaut's shoes, but the hand-held pads are much more flexible and generally preferred. Cost of the Electro-Adhesive Pads (2) and generator (hip or back-pack): \$40,000. In shoe form: \$50,000. Can hold up to 1000lbs; works *only* on metal. Not commonly available.

Flashlight — Small	\$5.00
Flashlight — Medium	\$10.00
Flashlight — Large	\$15.00
Flashlight — Unbreakable (Kel-lite):	
Small	\$24.00
Medium	\$28.00
Large	\$32.00
Very Large	\$35.00

Rechargeable, unbreakable flashlight that's 10 times brighter than most conventional types; quartz-halogen bulb, 12 inches (0.3m), 1.8lbs, 20,000 candle power. Cost: \$130.00, or 35,000 candle power — cost: \$160.00.

Portable Halogen Spotlight: 50,000 candle power	\$30.00
Treated Torch	\$8.00
Candle Stick — Per Doz.	\$8.00
Oil Lantern — 6 hours/1 pint	\$20.00
Oil Lantern — 12 hours/2 pints	\$30.00
Oil Lamp — 6 hours	\$30.00
Padlock — Light — 25 S.D.C.	\$5.00
Padlock — Medium — 50 S.D.C.	\$8.00
Padlock — Heavy — 75 S.D.C.	\$15.00
Padlock — Burglar proof, 60% to be picked	
80 S.D.C.	\$30.00
Handcuffs — Regular — 60 S.D.C.	\$25.00
Handcuffs — Heavy — 120 S.D.C.	\$50.00

Medical Bag: This 8lb bag is a complete Medic's field kit. Included are adhesive pads, bandages, gauze pads, adhesive tape, splints, sterile gloves, scissors, forceps, thermometer, needle, razor blades, pins, medicine, ointment, and salt tablets. Bag has back pack and shoulder straps, and is available in choice of camouflage, green or khaki. Cost: \$275.00.

Professional Medical Kit: A comprehensive first aid kit that contains six doses of each of the following: Antibiotics, anti-inflammatories, sedatives, painkillers. Assorted mini-instrument pack with scalpels, scissors, probes, etc.; a dozen in all. Tape, bandages, sutures, and four air filters. Cost: \$200. Available on the open market, without the drugs, at a cost of \$1500.

Machete: Complete with canvas sheath. 1D6 damage. Cost: \$30.00.

Wirecutters: 8 inch wirecutter has nonconducting handles to avoid the nasty "shock" of electrified fences. Complete with belt sheath. Cost: \$65.00.

Rations: Dry field rations; each 15lb case includes 12 meals. Crate is stocked with 12 cases, and has a total shipping weight of 200lbs. **Cost:** \$470.00.

Food Ration Packs: A food pack contains enough concentrated, vitamin enriched, freeze-dried rations to easily last two weeks. The food supply can be stretched to last four weeks if necessary. Geared for two-man consumption. **Cost:** \$2000. Limited availability.

Padded Helmet: A.R.: 10, **Cost:** \$25 to \$75.

Protective Goggles or Tinted Visor: Designed for use outdoors or for welding. Unbreakable plastic lenses. **Cost:** \$20.

Face Protector and Gas Mask: The mask can attach to most standard helmets, providing added protection to the face and eyes. Tinted visor and detachable air filter are standard. **Cost:** \$200. With gas mask modification and independent oxygen supply (2 hours): \$600.

Conventional Air Filter: Fits over nose and mouth. **Cost:** \$75.

Conventional Gas Mask: With a superior filtering system. **Cost:** \$100.

Gas Mask will filter out CS, smoke and a variety of military gases. Note: Not recommended as protection against nerve gas or radiation. **Cost:** \$50.00.

Sunglasses — Light Adjusting \$25.00
Sunglasses — Aviator \$45.00

Shooting Glasses: Change color and density in response to changes in light and weather. Also reduces glare and improves visibility. **Cost:** \$72.00.

Protective Goggles \$10.00
Basic Phone \$50.00
Telephone Answering Machine \$120.00
Tape Recorder — 30-60 min. recording time; pocket size \$100.00

Basic Computer \$650.00
IBM Compatible (MS Dos) \$1800.00
IBM Computer (top of the line) \$20,000
Monitor — Black and White \$100.00
Monitor — Green or Amber \$250.00
Monitor — Full Color \$800.00
Basic Printer \$250.00
Letter Quality Printer \$650.00
Laser Printer (top quality) \$2800.00
Telephone Modem \$150.00

Jet Pack: Speed: 80mph maximum, **Duration of Flight:** 40 minutes maximum. Jet Pack S.D.C.: 100. **Maximum Height:** 300ft. **Cost:** \$80,000.00. **Fuel Cost:** \$500.00 per tank (40 minute flight capacity).

Space Suit: (complete) Self-contained environmental suit, insulated, heat and cold shielded, oxygen and life support system; the whole works. **Cost:** \$250,000.00.

ACIDS

Organic Acid: (affects only organic substances) Does 2-12 damage each melee for a total of four melees.

Organic Acid: (concentrated) Does 4-24 damage per melee for a total of four melees.

Cleanser: Does 2-12 damage to organic; 1-6 damage to all other substances.

Metal Dissolver: (industrial) 4-24 damage per melee for a total of four melees. Does 1-8 damage per melee for a total of four melees to organics and plastics.

All acids are not common household items and must be acquired from a chemical supplier, industry or an illegal outlet. In the first two cases, large bulk orders may be required, and in the latter case, availability is extremely low (9% chance of getting the item) and multiply the cost ten times.

Costs: Organic I — \$75.00 per ½ gallon. Organic II — \$120.00 per ½ gallon. Cleanser — \$180.00 per ½ gallon. Metal Dissolver — \$600.00 per ½ gallon.

Nylon Cord: A variety of heavy-duty, all-purpose, nylon rope or cord is available. Average tension strength is 600lbs (270kg). Average length is 300ft (90m), at a cost of about \$100. Good availability.

CLOTHING

COMBAT/HUNTING

Police Style Jumpsuit: One-piece, zippers down the middle; large zippered chest pockets (2), front pockets (2), rear pockets (2), pencil/pen slot (left arm), sleeves and leg cuffs zipper for adjustability, bi-swing pleated back, and padded knees. **Cost:** \$80.00

Heavy Camouflage Coveralls: (Jumpsuit style) Insulated lining for cold weather (above freezing level cold), wrist and ankle elastic for tight fit, 6 pockets (chest, hip, rear).

Tiger Stripe Camouflage \$80.00
Tree Bark Camouflage \$85.00
Black or White \$75.00
Green \$75.00

Light Camouflage Coveralls: (Jumpsuit style) Cotton and polyester blend.

Tiger Stripe Camouflage \$50.00
Tree Bark Camouflage \$60.00
Black or White \$45.00
Green \$45.00

3-D Camouflage Suit: A multi-shade of drab green and brown, with approximately 250, individual hanging strips to blend into the foliage. Bonus: +10% on prowl skill when in woodland environment. **Cost:** \$150.00.

Below 30 Degree Coveralls: Insulated for prolonged exposure in the extreme cold, with thick, turtleneck collar that covers chin, nose, and mouth. The outer fabric is an acid resistant, cotton/polyester twill; has zippers at leg bottoms for easy removal; knit, windproof cuffs; sleeve pockets (one each arm) and six large pockets. Comes with zip-off hood. Suitable for up to 20 degrees below zero Fahrenheit. **Cost:** \$80.00.

Work Overall: (Jumpsuit Style) **Cost:** \$40.00

Expendable Lab Coat or Coveralls: Made from a special non-woven fabric that is acid, grease and lint resistant. Can be worn once or a dozen times, then thrown away. **Cost:** \$6.00.

Battle Dress Uniform (Fatigues):

Pants: 6 pockets, adjustable waist tab, button fly, drawstring cuffs.
Tiger Stripe Camouflage \$30.00

Tree Bark Camouflage	\$35.00
S.W.A.T. Black	\$30.00
Olive Green	\$30.00
White or Khaki	\$30.00
Shirts: (4 Pockets)	
Tiger Stripe Camouflage	\$30.00
Tree Bark Camouflage	\$30.00
S.W.A.T. Black	\$25.00
Olive Green	\$20.00
White or Khaki	\$20.00

Military Field Jacket: Includes adjustable collar and cuffs, epaulets, 4 large outer pockets with heavy brass zippers, hidden hood, waist cord and snap closures. **Cost:** \$60.00.

Reversible Flight Jacket — Light: Comes in navy blue, grey, green and brown. **Cost:** \$50.00.

Extreme Cold Weather Flight Jacket: (heavy, insulated) Comes in navy blue, grey, green, brown and white. **Cost:** \$100.00.

Battle Dress Utility: Shirt and pants in choice of arctic, desert, jungle or autumn forest camouflage. Shirt has two breast pockets, one pen pocket, and one (left-side) interior pocket. Pants equipped with hip, butt and thigh pockets. Lightweight (desert and jungle): \$65.00. Medium Weight (forest and mountain): \$90.00. Arctic Weight (down lined): \$365.

Battle Jacket: Comes equipped with breast, hip and interior pockets on both sides. A hidden pocket on the inside of the back is also useful. Available in camouflage, khaki, green or black. **Cost:** \$225.

Arctic Parka: High quality down lining provides protection in sub-zero conditions. Same pocket arrangement as Battle Jacket. Available in green and white only. **Cost:** \$450.

Wool Sweaters: Finest British quality knit with leather reinforcements at shoulders, elbows and neck. Available in cream, green or black. **Cost:** \$150.00.

Ponchos: Waterproof nylon. Useful for rain protection, ground cover, emergency tent, etc. 5ft by 5ft square. Available in camouflage. **Cost:** \$35.00.

Camouflage T-Shirt. Cost: \$8.00.

Khaki Bush Shorts. Cost: \$20.00.

HATS & HEAD COVERINGS

Police Style Riot Helmet: With ventilated transparent face shield. **Cost:** \$60.00.

Combat Helmet: Complete with liner and camouflage cover. **Cost:** \$40.00.

Safari Hat: A wide-brimmed hat perfect for shading the eyes in tropical sunlight and classy enough for an evening out on the town. Fasteners on each side for an easy 'Aussie style' flip. Available in choices of camouflage, cream, green, or khaki. **Cost:** \$125.00.

Utility Cap: A classic 'marine cover.' Available in choice of camouflage, green or khaki. **Cost:** \$14.50.

Beret: The classic wool beret. Available in green, black, or jungle camouflage. **Cost:** \$20.00.

Bandanna: In choice of colors. **Cost:** \$5.00.

Head Net: Covers hair and face, leaving only a slit for the eyes. **Cost:** \$15.00.

Camouflage Face Veil \$15.00

Navy Style Face Mask: Water and wind proof vinyl with soft wool lining; mouth tab with snap closure. **Cost:** \$8.00.

CLOTHES: GENERAL PURPOSE

Dancer's Leotards \$40.00

Speed Suit: (Jumpsuit Style). Trim cut, polyester/cotton fabric with one breast pocket and two front pockets. Used by race car drivers and pit crews. **Cost:** \$35.00.

Shop Service Coat: knee length, 4 pockets \$30.00

Turtleneck Shirt \$15.00

Thermal Parka, Hooded Sweat Shirt \$25.00

Sweat Shirt \$16.00

Flannel Shirt \$14.00

T-Shirt \$6.00

Dress Shirt \$40.00

Work Pants \$25.00

Denim Jeans \$30.00

Coveralls — Work \$35.00

Coveralls — Insulated \$60.00

Work Apron — Denim, 3 pocket \$12.00

Machinist's Apron — 6 pocket \$18.00

Lab Coat \$40.00

Windbreaker Jacket \$18.00

Light Lined Jacket \$30.00

Winter Jacket — Waist Length \$55.00

Winter Jacket — Hip Length \$80.00

Reversible Hunting Parka \$70.00

Insulated Survival Vest — 6 pocket \$50.00

Survival Coat — Insulated — 4 big pockets and hood \$100.00

Wool Cap \$80.00

Winter Ski Mask \$10.00

Arctic Trooper Hat with Fur Earflaps \$15.00

Work Gloves \$4.00

Leather Racing Gloves \$25.00

Dress Winter Gloves \$20.00

Heavy Winter Gloves \$15.00

Wool Mittens \$14.00

Leather Chopper Mitts \$20.00

Lectra-Mitts — Warmest Hand Protection Possible \$30.00

Tennis Shoes \$16.00

Running Shoes \$30.00

Work Shoes \$40.00

Dress Shoes/Boots \$80+

Steel Toe Shoes \$35.00

Steel Toe Boots \$60.00

Work Boots \$50.00

Waterproof Hunter's Boots \$40.00

High Quality 'Hunter/Woodsman, insulated boot \$140.00

Waterproof Rubber Boots: Ankle High \$20.00

Hip High 50.00

Rain Poncho \$30.00

Raincoat \$30.00

Rain Suit — Coat & Pants \$45.00

Rain Hat \$8.00

Hard Hat \$10.00

Sport Caps \$10.00

Baseball Cap \$8.00

Hat — Short Brim \$40.00

Hat — Large Brim \$50.00

Hat — Leather, large brim \$50.00

Cape — Short	\$60.00
Cape — Long	\$150.00
Cape — Long and Hooded	\$175.00
Robe — Light	\$30.00
Robe — Heavy	\$60.00
Robe — Hooded	\$80.00
Bathrobe	\$25.00

Note: Generally double or triple the price for fancy/dress articles and multiply the price by 10 times (or more, in some cases) for custom-made articles.

Security Guard Uniform

Usually Navy Blue or Brown Color

Jacket	\$35.00
Shirt	\$18.00
Tie	\$4.00
Trousers	\$25.00
Regulation Hat	\$15.00
Trouser Belt	\$10.00
Traditional belt and holster with 28 bullet loops	\$60.00
Badge and I.D. Pocket Case	\$18.00

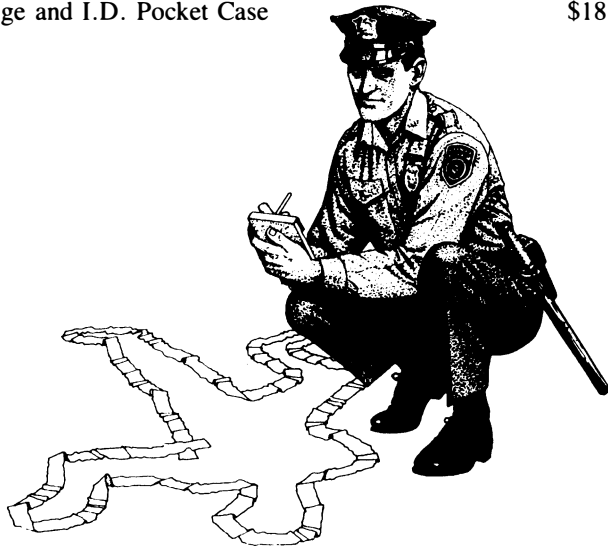

CONVENTIONAL VEHICLES

TYPICAL CONSUMER AUTOMOBILES:

Compact: A.R. 5, S.D.C. 300, Speed: 110mph (176.9kmph), Range: 350 miles (563km). **Cost:** \$6,500 and up.

Mid-Size: A.R. 6, S.D.C. 350, Speed: 110mph (176.9kmph), Range: 300 miles (482km). **Cost:** \$9,500 and up.

Full-Size Sedan: A.R. 7, S.D.C. 450, Speed: 120mph (193kmph), Range: 250 miles (402km). **Cost:** \$15,000 and up.

Luxury Sedan: A.R. 7, S.D.C. 450, Speed: 120mph (193kmph), Range: 250 miles (402km). **Cost:** \$25,000 and up. American and Japanese.

Sports Car: A.R. 5, S.D.C. 350, Speed: 120mph, unmodified, but can be supeed to 180mph, Range: 200 miles (321km). **Cost:** \$20,000 and up.

Corvette: A.R. 5, S.D.C. 300, Speed: 120mph, unmodified, Range: 270 miles (434km). **Cost:** \$15,000 and up.

Mini Van: A.R. 6, S.D.C. 350, Speed: 120mph (193kmph), Range: 350 miles (562km). **Cost:** \$15,000 and up.

Full-Size Van: A.R. 7, S.D.C. 400, Speed: 120mph (193kmph), Range: 200 miles (321km). **Cost:** \$9,000 and up.

Jeep (4 wheel drive): A.R. 6, S.D.C. 300, Speed: 120mph (193kmph), Range: 400 miles. **Cost:** \$12,000 and up.

Small Truck (4 wheel drive): A.R. 6, S.D.C. 350, Speed: 120mph (193kmph), Range: 400 miles. **Cost:** \$10,000 and up.

Small Truck: A.R. 6, S.D.C. 300, Speed: 120mph (193kmph), Range: 300 miles (482km). **Cost:** \$8,000 and up.

16ft Truck (U-Haul type): A.R. 7, S.D.C. 400, Speed: 120mph (193kmph), Range: 200 miles. **Cost:** \$20,000 and up.

24ft Truck (U-Haul Type): A.R. 8, S.D.C. 500, Speed: 120mph (193kmph), Range: 190 miles (305km). **Cost:** \$50,000 and up.

Semi-Truck (Cab only): A.R. 10, S.D.C. 600, Speed: 120mph (193kmph), Range: 150 miles (241km). **Cost:** \$90,000 and up. Add another \$90,000 for the cargo bed (trailer).

FOREIGN AND SPORTS CARS

BMW Sedan: German. A.R. 6, S.D.C. 350, Speed: 140mph (225kmph), Range: 250 miles (402km). **Cost:** \$80,000 to \$150,000.

BMW Sports Car: German. A.R. 5, S.D.C. 325, Speed: 180mph (290kmph), Range: 200 miles (321km). **Cost:** \$90,000 and up.

Delorean: Irish. A.R. 6, S.D.C. 325, Speed: 140mph (225kmph), Range: 200 miles (321km). **Cost:** \$60,000.

Jaguar: A.R. 5, S.D.C. 300, Speed: 180mph (290kmph), Range: 200 miles (321km). **Cost:** \$80,000.

Lamborghini Countach: Italy, A.R. 5, S.D.C. 350, Speed: 200mph + (321kmph), Range: 220 miles (355km). **Cost:** \$150,000 and up.

Mercedes Benz Sedan: German. A.R. 6, S.D.C. 350, Speed: 140mph (225kmph), Range: 250 miles (402km). **Cost:** \$90,000 to \$150,000 and up.

Mercedes Benz Sports Car: German. A.R. 6, S.D.C. 300, Speed: 200mph + (321kmph), Range: 220 miles (355km). **Cost:** \$100,000 and up.

Porsche: Italy. A.R. 5, S.D.C. 300, Speed: 200mph + (321kmph), Range: 200 miles (321km). **Cost:** \$65,000 and up.

Rolls Royce Luxury Sedan: Great Britain. A.R. 6, S.D.C. 450, Speed: 120mph (193kmph), Range: 190 miles (305km). **Cost:** \$100,000 and up.

Volvo Sedan: A.R. 5, S.D.C. 300, Speed: 140mph (225kmph), Range: 250 miles (402km). **Cost:** \$45,000 and up.

MOTORCYCLES

Motorcycle — Light: A.R. 5, S.D.C. 50, Speed: 90mph (144kmph), Range: 120 miles (193km). **Cost:** \$500.00 and up.

Motorcycle — Medium: A.R. 5, S.D.C. 100, Speed: 110mph (176kmph), Range: 350 miles (562km). **Cost:** \$1,800 - \$2,500.

Motorcycle — Heavy: A.R. 5, S.D.C. 150, Speed: 120mph (193kmph), Range: 350 miles (562km). **Cost:** \$5,500 - \$10,000.

AIRPLANES

Single Engine: A.R. 4, S.D.C. 400, Speed: 300mph (482kmph), Range: 680 miles (1040km).

Twin Engine: A.R. 5, S.D.C. 550, Speed: 420mph (670kmph), Range: 600 miles (964km).

Small Jet: A.R. 5, S.D.C. 850, Speed: 600mph (960kmph), Range: 1370 miles (2205km).

UNDERWATER VEHICLES

S.C.U.B.A. Scooter: Capable of pulling one to three divers.

The handles are designed for pulling the divers with minimum stress on the arm muscles. Cylindrical in shape with a front mounted rotor. Length: 3ft 1in (0.94m), Width: 1ft 5in (0.32m), Height: 10 inches (0.25m), Weight: Dry — 57lbs (26kg), Submerged — 5oz (0.23kg). **Maximum Depth:** 300ft. **Range:** 3 nautical miles. **Speed:** 3 knots. Can function on the water's surface or submerged. **S.D.C.:** 50.

S.C.U.B.A. Scooter Platform: Essentially a larger, more stable version of the little scooter. Unlike the small scooter, a diver can lay on top of the device to ride. The basic purpose is to carry S.C.U.B.A. divers and their equipment into the sea and return them safely. It can also serve as a stable platform (precisely controlled) for underwater photography. Length: 9ft 3in (2.8m), Width from side fin tip to fin tip is 4ft (1.2m), Weight: 270lbs — Dry, 181lbs submerged. **Maximum Depth:** 1970ft (600m). **Speed:** 5 knots. **Range:** 15 nautical miles. Accommodates one pilot, but can pull up to four more divers (cargo capacity is 1000lbs/450kg). **S.D.C.:** 120.

Sea Sled or CAV (Construction Assistance Vehicle), is designed to function as an underwater pickup truck capable of delivering up to 2000lbs (910kg) of wet weight cargo. The cockpit holds two, and has with it an open cargo bed in the rear. Length: 27ft (8.23m), Cargo bed dimension: 11 × 4.5 × 1.5ft (3.35 × 1.37 × 0.46m). **Maximum Depth:** 150ft (45.7m), **Speed:** 3 knots, **Range:** 15 miles (24km). **Life Support:** 5 compressed air bottles, 2 hour air supply. Can function on the surface or submerged. **S.D.C.:** 270.

Waterdinger: A small, diver assist vehicle capable of carrying two S.C.U.B.A. divers and equipment. Length: 7ft (2.1m), **Cargo Capacity:** 750lbs — Dry (340kg), **Maximum Depth:** 300ft (91m), **Speed:** 2 knots, **Range:** 4 nautical miles. **S.D.C.:** 150.

Two Diver Submersible Transport Vehicle: There are a variety of two-man, research submersibles with similar capabilities. Length: 12 to 16ft (3.6m to 4.9m). **Maximum Depth:** 2000ft (610m). **Speed and Range:** at 1.5 knots the range is 100 miles (160m), at 6 knots the range is about 45 miles (72km) and at 9 knots the range is 10 miles (16km). **Life Support Endurance:** 18 hours plus 6 hours emergency. **S.D.C.:** 550.

SPECIAL GIMMICKS

- 1. Tailor-Made Clothing** with *secret pockets* and seams for concealment. For example, a seam or cuff can be designed to hold wire or a small tool. The same is true with tiny pouches and pockets carefully designed to be invisible upon quick examination. **Note:** These are small, flat pockets designed for small/tiny implements that might not be felt in a body search. Guns or wallets will be far too bulky. **Cost:** Add \$50 for *each* hiding place/pocket and \$100 to the overall cost of the clothing.
 - 2. Belt Buckle Compartment.** **Cost:** \$35.
 - 3. Belt with a Secret Lining** to hold wire, keys and small, flat tools. **Cost:** \$50.
 - 4. Flash Powder:** A simple chemical reaction causes the powder to ignite in a blinding flash and a small puff of smoke. Does no damage, but everyone exposed to the flash (within 12ft) loses initiative. **Cost:** \$20 per ounce.
 - 5. Itching Powder:** Makes its victim itchy and uncomfortable. Lasts 1D4 hours or until washed off. Affects only bare skin. Victims are annoyed and distracted; -4 on initiative. **Cost:** \$10 per ounce.
 - 6. Goblin Dust:** Often a homemade powder composed of fine soot, ash and dirt. The dust is usually packaged in small packets that can be torn and thrown or blown in an opponent's face. Large paper bags can be filled and used to hit an opponent like a club, breaking open and dumping in the person's face. There's a 45% chance of getting the dust in the person's eyes and blinding him for 1D4 melees (-6 to strike, parry and dodge). **Cost:** About two bucks for a five pound batch.
 - 7. Mini-Smoke Bomb:** A small, golf ball size and shaped item, easy to conceal or palm, that emits a cloud of smoke that fills a 10 foot (3m) area. Colors include: grey, black, yellow, red, white and green. **Cost:** \$5 each.
 - 8. Mini-Stink Bombs:** These look just like the smoke-bomb, but emits a cloud of horrible stench. Fills a 10ft area and lasts 1D6 minutes. This stench is 20 times worse than the commercial prank types. Victims will involuntarily gag, eyes will water and some may even vomit. Unless a savings throw is made, the people exposed to the stench will forfeit half their attacks that melee and run out of the area. Characters who endure the stench, but fail to save, lose two melee attacks and are -1 to strike, parry and dodge. A successful save means the stench has no significant effect. Savings throw: 16 or higher. **Cost:** \$30 each.
-

Experience Tables

Nightbane & Guardian

1	0,000-2,400
2	2,401-4,600
3	4,601-9,200
4	9,201-18,400
5	18,401-28,300
6	28,301-48,000
7	48,001-78,000
8	78,001-110,000
9	110,001-150,000
10	150,001-200,000
11	200,001-250,000
12	250,001-310,000
13	310,001-380,000
14	380,001-470,000
15	470,001-600,000

Snakebird & Mystic

1	0,000-2,050
2	2,051-4,100
3	4,101-8,250
4	8,251-16,500
5	16,501-24,600
6	24,601-34,700
7	34,701-49,800
8	49,801-69,900
9	69,901-95,000
10	95,001-130,100
11	130,101-180,200
12	180,201-230,300
13	230,301-280,400
14	280,401-340,500
15	340,501-400,600

Doppelganger

1	0,000-1,900
2	1,901-3,800
3	3,801-7,300
4	7,301-14,600
5	14,600-21,000
6	21,001-30,000
7	30,001-40,000
8	40,001-55,000
9	55,001-75,000
10	75,001-105,000
11	105,001-140,000
12	140,001-190,000
13	190,001-245,000
14	245,001-300,000
15	300,001-335,000

Nemtar/Hollow Men

1	0,000-2,000
2	2,000-4,000
3	4,000-8,500
4	8,501-17,000
5	17,001-24,500
6	24,501-35,600
7	35,601-49,700
8	49,701-69,800
9	69,801-94,900
10	94,901-130,000
11	130,001-180,000
12	180,001-228,100
13	228,100-279,200
14	279,201-339,300
15	339,301-400,500

Nightbane Sorcerer & Nightbane Mystic

1	0,000-2,600
2	2,601-5,000
3	5,001-10,000
4	10,001-20,000
5	20,001-30,000
6	30,001-50,000
7	50,001-80,000
8	80,001-120,000
9	120,001-170,000
10	170,001-230,000
11	230,001-300,000
12	300,001-380,000
13	380,001-470,000
14	470,001-600,000
15	600,001-800,000

Wampyr

1	0,000-2,700
2	2,701-5,400
3	5,401-10,800
4	10,801-21,600
5	21,601-31,600
6	31,601-42,800
7	42,801-62,000
8	62,001-90,000
9	90,001-120,000
10	120,001-170,000
11	170,001-220,000
12	220,001-290,000
13	290,001-400,000
14	400,001-500,000
15	500,001-700,001

Priest of Night

1	0,000-2,140
2	2,140-4,300
3	4,301-8,600
4	8,601-17,200
5	17,201-25,500
6	25,501-35,600
7	35,601-50,700
8	50,700-71,500
9	71,501-96,600
10	96,601-133,700
11	133,701-186,800
12	186,801-240,900
13	240,901-291,000
14	291,001-350,000
15	350,001-400,000

Hound & Hunter

1	0,000-2,500
2	2,501-5,000
3	5,001-10,000
4	10,000-20,000
5	20,000-35,000
6	35,001-55,000
7	55,001-85,000
8	85,001-130,000
9	130,001-180,000
10	180,001-235,000
11	235,001-285,000
12	285,001-350,000
13	350,000-425,000
14	425,001-550,000
15	550,001-700,000

Ashmedai, Psychic & Sorcerer

1	0,000-2,240
2	2,241-4,480
3	4,481-8,960
4	8,961-17,920
5	17,921-25,920
6	25,921-35,920
7	35,921-50,920
8	50,921-70,920
9	70,921-95,920
10	95,921-135,920
11	135,921-185,920
12	185,921-225,920
13	225,920-275,920
14	275,921-335,920
15	335,921-395,920

Nightprince & Vampire

1	0,000-5000
2	5,001-10,000
3	10,001-20,000
4	20,001-40,000
5	40,001-80,000
6	80,001-120,000
7	120,001-160,000
8	160,001-200,000
9	200,001-250,000
10	250,001-300,000
11	300,001-400,000
12	400,000-500,000
13	500,001-600,000
14	600,001-1 Million
15	1 Million-2 Million

Nightlord

1	0,000-8,000
2	8,001-16,000
3	16,001-32,000
4	32,001-56,000
5	56,001-86,000
6	86,001-120,000
7	120,001-180,000
8	180,001-250,000
9	250,001-325,000
10	325,001-400,000
11	400,001-500,000
12	500,001-600,000
13	600,000-800,000
14	800,000-1,200,000
15	1,200,000-2,400,000

Hound Master

1	0,000-3,000
2	3,001-6,000
3	6,001-12,000
4	12,000-24,000
5	24,001-50,000
6	50,001-80,000
7	80,001-120,000
8	120,001-170,000
9	170,001-220,000
10	220,001-290,000
11	290,001-375,000
12	375,001-450,000
13	450,001-550,000
14	550,001-750,000
15	750,001-1 Million

Explore the Palladium Megaverse®

The Palladium “Fantasy” Role-Playing Game®

A world of epic fantasy, incredible magic and amazing beings including the shape-changing Changeling, ferocious Wolfen, monstrous Melech, dragons, giants, trolls, dragons and creatures that defy description. Players can create scores of human and inhuman characters.

Combat is fast and fun.

Magic is different! There is spell casting wizardry, the wards of the Diabolist, the circles of the Summoner, and the powers of Druidism. Plus the mind-powers of the Mind Mage, elemental magic, the enchantments of the Alchemists, the blessings of the priest, the dark magic of the witch and magic items and creatures galore.

Sourcebooks define the world, offer new types of player characters, different player races and monsters, adventures and/or adventure ideas. This line is currently Palladium's second best seller (behind *Rifts*® and just edging out *Heroes Unlimited*™). • \$26.95 — 336 pages.

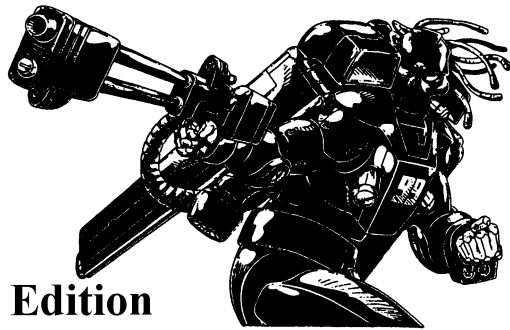

Rifts® Ultimate Edition

Dimensional *Rifts* are tears in the very fabric of space and time. Portals to other worlds. Doorways that allow the incredible, monstrous and magical to invade our world. Reshaping it into an alien landscape that is both frightening and wondrous, alien and yet strangely familiar.

Super-science, bionics, power armor and robots collide with the forces of magic, Techno-Wizardry, dragons and demons from the Rifts. Humankind struggles on the brink of extinction, and the possibilities are endless.

Discover a world where anything is possible and you are limited only by your imagination. • \$39.95 – 376 page hardcover RPG.



Heroes Unlimited™ RPG, 2nd Ed.

Create any type of superhuman hero you can imagine.

Aliens, mutants, robots, cyborgs, super-soldiers, psychics, super-sleuths, martial arts masters, gun-toting vigilantes, super-geniuses, masters of magic, demigods, Mega-Heroes and more!

Over 100 super abilities, plus scores of sub-powers and 40+ psionic powers. Over 100 magic spells, plus enchanted weapons and objects.

Everything one needs to play other than dice and friends are in this complete role-playing game. Cover by Jim Steranko. Written by Kevin Siembieda • \$26.95 — 352 pages.

After the Bomb® RPG

Discover the world of mutant animals. Play it as a stand-alone game environment or combine it with *Heroes Unlimited*™, but check it out.

Mutant animal creation rules that make building your mutant characters fast, fun and challenging. Over 100 mutant animals presented. More than 40 animal powers and psionics; many more if you include weird abilities exclusive to certain animal species. • \$24.95 — 224 pages.

Ninjas & Superspies™ RPG

Over 40 different types of martial arts, oriental mysticism, and superhuman abilities combined with spies, gizmos, super-vehicles, cybernetic implants and disguises, and more to create the ultimate spy and combat game. A complete role-playing game with everything you need to play. A complete game in itself as well as completely interchangeable with *Heroes Unlimited*™. Written by Erick Wujcik. • \$20.95 – 176 pages.

Nightbane® RPG

The world has never been the same since Dark Day. Some say the world governments have been supplanted, taken over by ... god only knows what. That doppelgangers can steal one's identity and life, and that demons and monsters lurk in the shadows. Creatures of evil who serve the Nightlords.

But the lords of shadow are not unopposed. There are creatures of light as well as creatures born from darkness but champion the light. These are the Nightbane. Ordinary people, many teenagers, able to shed their human facade and assume a supernatural alter ego. A monstrous, inhuman visage imbued with superhuman power and the stuff of magic. Written by C.J. Carella. • \$24.95 – 240 pages.

Dead Reign® RPG – The Zombie Apocalypse

It is the aftermath of the zombie apocalypse. Civilization is gone, the dead reign, and the living fight to survive against impossible odds. Tales of zombies, human survival and horror as a fast-paced, easy to learn game and sourcebooks. Think you know all about zombies? Think again.

Zombie combat rules, vehicles and equipment. Six iconic Apocalyptic Character Classes (O.C.C.s) and Ordinary People with 40+ occupations to choose from. Seven types of zombies plus the Half-Living. Secrets of the Dead and tips on fighting zombies. Death Cults, their Priests, power over zombies and goals. 101 Random Scenarios, Encounters and Settings. 100 Random Corpse Searches and other tables. Quick Roll Character Creation tables (10 minutes). A complete role-playing game by Siembieda and others. • \$24.95 – 224 pages.

Splicers® RPG

Splicers® is a new science fiction RPG set on a devastated world where machines rule, and human beings are vermin who are hunted and exterminated. The human struggle is complicated by a nano-virus that instantly turns metal objects touched by human flesh into killing machines. Consequently, humans have been forced to turn to organic technology to battle the world-dominating machines if they hope to reclaim any portion of their planet for themselves. Mega-Damage System – compatible with *Rifts*®, *Phase World*®, *Chaos Earth*™ and *Mechanoid Space*™. • \$23.95 – 224 pages. Written by Carmen Bellaire.

Palladium Books Inc.
39074 Webb Court
Westland, MI 48185

www.palladiumbooks.com

Copyright 2014 Palladium Books Inc. All rights reserved, worldwide. Palladium Books®, *Rifts*®, *Megaverse*®, *Nightbane*®, *The Mechanoids*®, and *After the Bomb*® are registered trademarks of Palladium Books Inc. *Heroes Unlimited*, *Ninjas & Superspies*, *Beyond the Supernatural*, *Splicers*, and *Rifts*® *Chaos Earth* are trademarks owned and licensed by Palladium Books Inc.

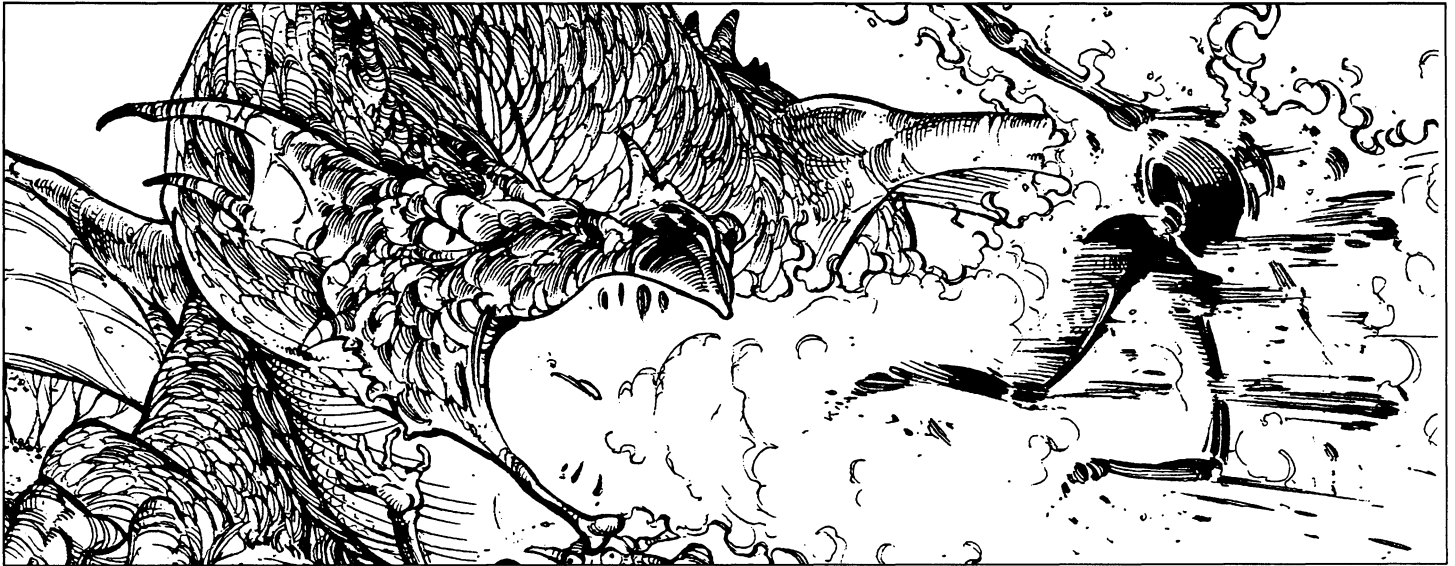

Fantasy Role-Playing is hot!

The Palladium Fantasy Role-Playing Game®, 2nd Ed.

The basic game is all you need to play. The 336 page rule book lays out the unique fantasy world of Palladium at your fingertips. Disciplines of magic and powers unlike any other RPG. The Palladium Fantasy RPG® includes:

- Step by step character creation that's easy and fun. Create fictional characters that will come to vivid life.
- Fast, realistic combat, with initiative, parries, dodges, entanglement, paired weapons and more. The original D20 system of combat!
- Wolfen, Changelings, Ogres, Orcs, Goblins, Kobolds, Dwarves, Elves and other inhuman races available as player characters.
- Over 20 character classes with in-depth skills and training.
- Over 300 magic spells for the Wizard character.
- 60 wards for the Diabolist character.
- 50 magic circles for the Diabolist & Summoner characters.
- 80 psionic powers for the Mind Mage.
- Druids, Healers and Witches too.
- Men at arms characters with real power and distinct skills.
- Pages and pages of magic items, rune weapons, holy weapons, potions, poisons and herbs, armor and other weapons.
- Demons, world information and more.
- \$26.95 — 336 pages, written by Kevin Siembieda.

Fantasy Sourcebooks

Old Ones™, 2nd Edition: Over 50 different cities, towns and forts. The Timiro Kingdom mapped and described, plus adventure galore. \$24.95 — 224 pages.

Adventures on the High Seas™, 2nd Edition: Ship to ship combat rules, the Necromancer, Sailor and many other character classes, six adventures and over 20 islands to explore. \$24.95 — 224 pages.

Monsters & Animals™, 2nd Edition: Over 100 monsters, nearly 200 animals, more world information and details. \$24.95 — 240 pages!

Dragons & Gods™, 2nd Edition: Over 40 gods, 20 demonic lords and their powers, priests and magic. Plus 14 dragons, their habits and history, holy weapons and more. \$24.95 — 232 pages!

The Western Empire™, 2nd Edition: An in depth look at the "Empire of Sin." 18 cities, 13 provinces, new herbs, magic items and adventure. \$24.95 — 224 pages.

Baalgor Wastelands™, 2nd Edition: The hostile land mapped and described, new monsters, new player races, adventure and adventure ideas. \$24.95 — 216 pages.

Mount Nimro™, 2nd Edition: The war between the giants and the monstrous, winged Gromek. New player characters and monster races, history, world information, and adventure. \$20.95 — 160 pages.

Yin-Sloth Jungles™: The Undead Hunter, Witch Hunter, Beastmaster, jungle tribes, villages, and secrets. \$20.95 — 160 pages.

Island at the Edge of the World™: Crystal magic, the Ghost Kings, the secret history of Changelings and the Circle of Elemental Magic that threatens the world! Still \$20.95 — 144 pages.

Eastern Territory™: Explore the Domain of Man with its many outposts, towns and cities mapped and described. The trouble with monsters and loads of adventure ideas. \$24.95 — 224 pages.

The Northern Hinterlands™: Explore the foothills of the Land of the Damned, Ophid's Grasslands, the northwestern woodlands and discover the secrets they hold. Written by Bill Coffin. \$24.95 — 192 pages.

The Land of the Damned™ 1: Chaos Lands: The mysterious Land of the Damned, closed off from the rest of the world. And for good reason. Find out why! \$24.95 retail — 192 pages.

The Land of the Damned™ 2: Eternal Torment: \$24.95 retail — 224 pages.

Wolfen Empire™ Sourcebook: Outlines Wolfen society, land holdings and culture, helping to set the stage for the upcoming *Wolfen War*. Tribe descriptions, 6 full adventures and more. \$20.95 — 160 pages.

Want to know more?

Send us a letter or post card with your name and address and we'll send you our latest catalog absolutely free.

Or check us out online at www.palladiumbooks.com

Palladium Books Inc. 39074 Webb Court, Westland, MI 48185

Palladium Role-Playing, endless adventure and fun

Copyright 2005 Palladium Books Inc. All rights reserved, worldwide.

Rifts®, The Palladium Fantasy Role-Playing Game®, After the Bomb®, The Rifter®, and Megaverse® are registered trademarks owned and licensed by Palladium Books Inc. and Kevin Siembieda. Heroes Unlimited, Land of the Damned, Ophid's Grasslands, Western Empire, Old Kingdom, Baalgor Wastelands, Yin Sloth, Old Ones, Wolfen, Mind Mage, Diabolist, and other titles, names, and likenesses are trademarks of Palladium Books Inc. & Kevin Siembieda.



RIFTS®

- Imagine Earth transformed into an alien landscape.
- Humans exist – barely. And we are not alone.
- Aliens and monsters emerge from the Rifts – holes torn in the fabric of space and time, connected to countless worlds and realities.
- Ancient gods, demons and magic have returned.
- Magic and technology clash.
- Hundreds of character classes, many inhuman.
- *Rifts® Ultimate Edition* is the core RPG rule book.
- Expansive world setting with 90+ sourcebooks to draw upon.
- Rifts®, your portal to endless adventure.
- Limited only by your imagination.

www.palladiumbooks.com

© 2014 Palladium Books. Rifts®, Megaverse®, Nightbane® and other titles, slogans and likenesses are trademarks of Palladium Books, Inc. Palladium Books - 39074 Webb Court, Westland, MI 48185 USA - 734-271-2903 order line.

Other RPG Worlds from Palladium Books®:

- *Rifts®* – the ultimate role-playing experience.
- *Rifts® Chaos Earth®* – Play the apocalypse as it happens.
- *Splicers®* – Weird science. Bio-tech battles insane robot legions.
- *Robotech® RPG* – All eras of the TV show brought to life.
- *Dead Reign® RPG* – Can you survive the Zombie Apocalypse?
- *Palladium Fantasy RPG®* – Unique world, monsters as player characters, magic and more.
- *Heroes Unlimited™ RPG* – Play any hero; mutants, aliens, cyborgs, superhumans, mages, immortals and more.
- *Nightbane® RPG* – Conspiracy, magic, horror and monsters.
- *Beyond the Supernatural™ RPG* – Modern horror and suspense.
- *Ninjas and Superspies™*, and more.

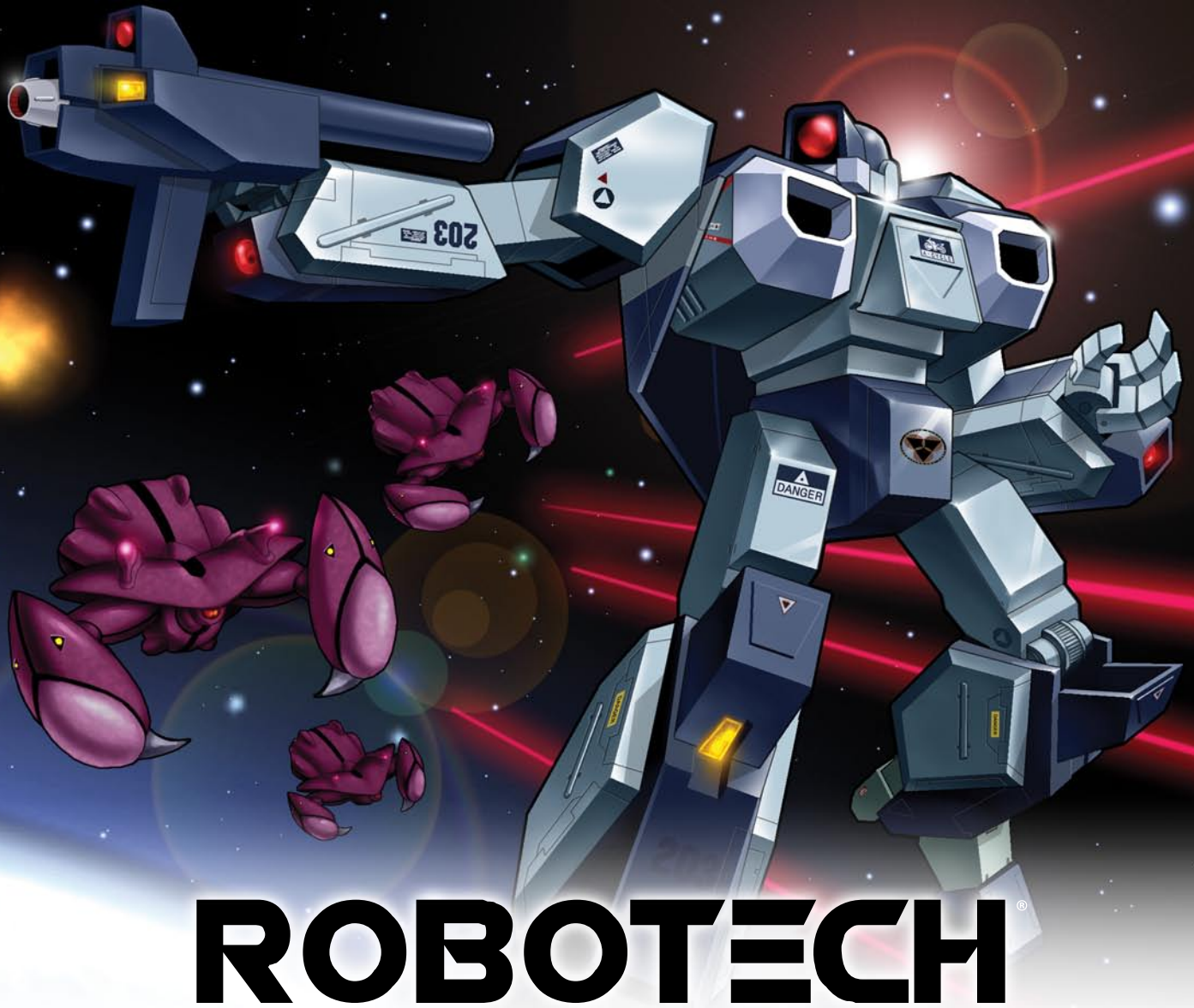

ROBOTECH®

Role-Playing Game and Sourcebooks

- **Four generations of heroes and mecha** • **Giant transformable robots** • **Alien invaders** • **Battle for control of the Earth** • **Combat takes to the stars** • **All presented in a core rule book and dynamic set of epic sourcebooks** • **Easy to learn** • **Fun to play** • **Quick character generation** • **Fast combat** • **Captures the action and adventure of the anime TV series** • **Isn't it time you joined the adventure?**

Robotech® "Core Rules" – Shadow Chronicles® RPG Hardcover

All the rules and information a player needs to start a Robotech® role-playing campaign with Admiral Rick Hunter and the United Earth Expeditionary Force trekking across the galaxy.

- Human mecha: Alphas, Betas, Cyclones & much more.
- Five character classes. 25 different Military Specialties.
- Invid mecha, Haydonites, and alien enemies.
- Quick roll character tables. Make a character in 15 minutes.
- A complete, stand-alone RPG.
- 224 pages. Cat. No. 550HC. 8½ x 11 size, hardcover.

Robotech®: The Macross® Saga Sourcebook – Cat. No. 551

A treasure chest packed with the iconic mecha, vehicles, weapons and characters that made Robotech® famous. Valkyries, Destroyers, ground vehicles, aircraft, spacecraft, weapons, Zentraedi soldiers, Zentraedi mecha, alien invaders, heroes, villains, and more.

- All the iconic Macross mecha, vehicles, weapons & characters.

www.palladiumbooks.com

Robotech®: The Masters Saga™ Sourcebook – Cat. No. 552

Tons of never before seen stats and descriptions for the many weapons, armor, mecha and robots of the Army of the Southern Cross.

- The Army of the Southern Cross™ – all 15 branches and their mecha!

Robotech®: New Generation™ Sourcebook – Cat. No. 554

The battle for the liberation of Earth starts here.

- Kit-bashed mecha combining parts from different mecha.
- Invid Hives, world overview, key characters and adventure ideas.

Robotech®: Genesis Pits™ Sourcebook – Cat. No. 555

The Invid Genesis Pits, their purpose, function.

- Inorganics and other war machines of the Invid Regent.
- Genesis Pit mutations and monsters.

Robotech®: Expeditionary Marines Sourcebook – Cat. No. 553

Join the UEEF (United Earth Expeditionary Force) led by Admiral Rick Hunter as they travel across the galaxy liberating planets from the bondage of the Invid Regent, the Robotech Masters and other tyrants.

- New mecha, weapons, and character classes of the UEEF Marines.
- New alien species and allies. Planet hopping and more.



ROBOTECH

RPG TACTICS™

Main Boxed Game – Cat. No. 55100 – Available Now!

A fast-paced, strategy battle game that captures the speed and action of Robotech®. Play Earth defenders or Zentraedi invaders.

- Scalable from small squad skirmishes to mass battles.
- Turn-based system of play and uses D6. Two or more players.
- 34 highly detailed game pieces. 6mm scale.
- 112 page color rule book with paint guide and index.
- 53 laminated, color game cards.
- 24 custom dice, two decal sheets and more.
- Assembly and painting required. Glue not included.
- \$99.95 retail – Cat. No. 55100 – shipping now!
- Available in North and South America, the EU, Australia & New Zealand.

Note: Each product contains plastic game pieces requiring assembly and painting. Glue not included. This is not a toy. Small parts, not suitable for children under the age of 13. Adult supervision advised. Images shown here are not to scale.



UEDF Valkyrie Wing™ – Cat. No. 55201

Build your fleet of Earth defenders with the Valkyrie Veritech Fighter; six game pieces total. **\$36.95 retail.**

- 2 Valkyries in Fighter mode.
- 2 Valkyries in Guardian mode.
- 2 Valkyries in Battloid mode.
- Multiple heads for making the VF-1A, VF-1J, VF-1R & VF-1S.



UEDF Tomahawk/Defender Destroids™ – Cat. No. 55202

Expand your Destroid squad with these formidable walking tanks; four game pieces total. **\$32.95 retail.**

- 2 Tomahawk Destroids – the main battle tank of Destroids, brimming with powerful particle beam cannons for arms, and wielding a battery of missiles and an array of other weapons.
- 2 Defender Destroids – a long-range, anti-aircraft juggernaut capable of shooting down incoming Zentraedi Battlepods and Gnerl Fighters.



UEDF Spartan/Phalanx Destroids™ – Cat. No. 55203

Add some long-range power and up-close punch to your army with these valuable Destroids; four game pieces total. **\$32.95 retail.**

- 2 Spartan Destroids – civil defense, riot control and deadly in hand to hand combat.
- 2 Phalanx Destroids – a walking, long-range missile artillery unit.



Zentraedi Regult Battlepods™ – Cat. No. 55401

Expand your Zentraedi forces with their main infantry battle mecha; six game pieces total. **\$36.95 retail.**

- 6 Regult Tactical Battlepods – the lightning quick Regults, armed with a pair of particle cannons and auto-cannons, attack in wave after wave.



Zentraedi Artillery Battlepods™ – Cat. No. 55402

Give your Zentraedi legion greater firepower with these artillery and support Battlepods; four game pieces total. **\$36.95 retail.**

- 4 Zentraedi Support Battlepods, each of which can be made into:
 - Gluhaug-Regult – Light Artillery Battlepod
 - Serauhaug-Regult – Heavy Artillery Battlepod
 - Telnesta-Regult – Experimental Particle Beam Battlepod
- Four game pieces total.**



Zentraedi Glaug Command™ – Cat. No. 55403

This diverse pack provides your Zentraedi forces with greater tactical capabilities; three game pieces total. **\$36.95 retail.**

- 1 Glaug Officer's Battlepod – the fast and deadly mecha of Zentraedi field leaders.
- 1 Quel-Regult Scout Battlepod – the stealthy eyes and ears of your Zentraedi battle force; electronic warfare capabilities.
- 1 Quel-Gulnau Recovery Pod – enhances the Glaug's ability to bring in Battlepod reinforcements. **Note:** This figure has NEVER before been offered by any company.

Can YOU survive the Zombie Apocalypse?



The Dead Reign® RPG series

Dead Reign® RPG – “Core Rules.” It is the aftermath of the *zombie apocalypse*. The dead reign and the living fight against impossible odds. Can you survive? Find out with this fast-paced horror game. Easy to learn. Fast character creation and combat.

- **Zombie combat and survival rules, vehicles and equipment.**
- **6 iconic Character Classes plus Ordinary People (40+ occupations).**
- **7 types of zombies, plus the Half-Living.**
- **101 Random Scenarios, Encounters, Settings and other tables.**
- **\$22.95 retail – 224 pages – Cat. No. 230. Available now.**

Civilization Gone™ Sourcebook

Civilization has crumbled to nothing. There is no army. No government. No help coming. What now?

- **Madmen, Psychopaths, villains, heroes and protectors.**
- **House, home and survivor camp tables, resources & encounters.**
- **\$12.92 retail – 64 pages – Cat. No. 231. Available now.**

Dark Places™ Sourcebook

Travel the rails and urban underground to move about undetected by zombies.

- **Worm Meat, Bug Boy, Sewer Crawler & Impersonator Zombies.**
- **Traveling the rails, sewers and other dark places.**
- **Random encounter tables, boxcar content tables, and much more.**
- **\$12.92 retail – 64 pages – Cat. No. 232. Available now.**

Endless Dead™ Sourcebook

The zombies grow in number and strangeness. Can humankind survive?

- **Zombie amalgamations, tables and encounters.**
- **New player characters & timetables for your campaign.**
- **Weaponizing vehicles, vehicle combat rules, and military bases.**
- **Creating survivor caravans, hideouts, Safe Havens & more.**
- **\$16.95 retail – 96 pages – Cat. No. 233. Available now.**

Other horror titles from Palladium Books®

Beyond the Supernatural™ RPG **Nightbane® RPG**

Fear the Reaper™ Sourcebook

Heroes who, like knights of old, travel the highways fighting zombies and helping survivors.

- **Comprehensive background on the Road Reapers.**
- **Their code, missions, weapons, strategies and tactics.**
- **The Terror Zombie and more.**
- **\$12.95 retail – 48 pages – Cat. No. 234. Available now.**

Graveyard Earth™ Sourcebook

The Zombie Apocalypse across the globe; provides a world overview and many adventure ideas.

- **Many tables for settings, encounters and adventure hooks.**
- **Random Safe Havens by region, and Survivor Leaders.**
- **How to get home from abroad, zombie threat levels & more.**
- **\$12.95 retail – 64 pages – Cat. No. 235. Available now.**

Hell Followed™ Sourcebook

This big, 160 page sourcebook begins to redefine the zombie genre. It broadens the field of possibilities and expands upon the modern zombie mythos. It is full of twists and surprises you will not expect.

- **11 new types of terrifying zombies.**
- **7 player characters, plus Masked Lunatics – heroes or madmen?**
- **21 disasters to complicate survival, and urban survival.**
- **Government enclaves, conspiracy theories and more.**
- **\$20.95 retail – 160 pages – Cat. No. 236. Available now.**



Palladium Books® Check List & Order Form

Dept. P-16, 39074 Webb Court, Westland, MI 48185

Name: _____ Address: _____

City: _____ State: _____ Zip/Postal Code: _____ Country: _____

Credit Card Number: _____ Expiration Date: _____ Visa MasterCard

Telephone Number: _____ Signature: _____ AMEX Other

The Rifter® Series

- ___ 175 The Rifter® #75 – \$13.95
- ___ 176 The Rifter® #76 – \$13.95
- ___ 177 The Rifter® #77 – \$13.95
- ___ 178 The Rifter® #78 – \$13.95
- ___ 179 The Rifter® #79 – \$13.95

Splicers® Note: Sourcebooks coming soon.

- ___ 200 Splicers® RPG – \$23.95

Dead Reign®

- ___ 230 Dead Reign® RPG – \$22.95
- ___ 231 SB 1: Civilization Gone™ – \$12.95
- ___ 232 SB 2: Dark Places™ – \$12.95
- ___ 233 SB 3: Endless Dead™ – \$16.95
- ___ 234 SB 4: Fear the Reaper™ – \$12.95
- ___ 235 SB 5: Graveyard Earth™ – \$12.95
- ___ 236 SB 6: Hell Followed™ – \$20.95
- ___ 237 SB 7: In the Face of Death™ (coming)

Rifts® Novels

- ___ 301 Sonic Boom™ – \$9.95
- ___ 302 Deception's Web™ – \$9.95
- ___ 303 Treacherous Awakenings™ – \$9.95
- ___ 304 Tales of the Chi-Town 'Burbs™ – \$12.95
- ___ 305 Rifts® Path of the Storm™ – \$12.95

Weapons Books

- ___ 401 Weapons and Armor™ – \$8.95
- ___ 402 Weapons and Castles™ – \$8.95
- ___ 403 Weapons and Assassins™ – \$9.95
- ___ 404 Weapons & Castles of the Orient™ – \$9.95
- ___ 409 Exotic Weapons™ – \$9.95
- ___ 410 European Castles™ – \$9.95

Palladium Fantasy RPG®

- ___ 450 The Palladium Fantasy RPG® – \$26.95
- ___ 4500HC Palladium Fantasy RPG® 30th Anniversary Hardcover – \$50.00
- ___ 451 Dragons & Gods™ – \$24.95
- ___ 453 Old Ones™ 2nd Ed. – \$24.95
- ___ 454 Monsters & Animals™ 2nd Ed. – \$24.95
- ___ 455 Adventures on the High Seas™ – \$24.95
- ___ 458 Island at the Edge of the World™ – \$20.95
- ___ 459 Yin-Sloth Jungles™ – \$20.95
- ___ 462 Western Empire™ – \$24.95
- ___ 463 Baalgor Wastelands™ – \$24.95
- ___ 464 Mount Nimro™ – \$20.95
- ___ 465 Eastern Territory™ – \$24.95
- ___ 466 Library of Bletherad™ – \$20.95
- ___ 467 Northern Hinterlands™ – \$24.95
- ___ 468 Land/Damned 1: Chaos Lands™ – \$24.95
- ___ 469 LoD 2: Eternal Torment™ – \$24.95
- ___ 470 LoD 3: The Citadel – \$24.95 (coming)
- ___ 471 Wolfen Empire™ – \$20.95
- ___ 472 Mysteries of Magic™ One: Heart of Magic – \$16.95
- ___ 474 Bizantium/Northern Islands™ – \$20.95
- ___ 475 Garden of the Gods™ – \$16.95 (coming)

Heroes Unlimited™ / After the Bomb®

- ___ 500-2 Heroes Unlimited™, 2nd Ed. – \$26.95
- ___ 5000HC Heroes Unlimited™ 30th Anniversary Hardcover – \$50.00
- ___ 501 Villains Unlimited™ Revised – \$24.95
- ___ 503 After the Bomb® RPG – \$24.95
- ___ 505 Road Hogs™ (After the Bomb® II) – \$9.95
- ___ 507 Mutants Down Under™ (AB III) – \$9.95
- ___ 511 Mutants of the Yucatan™ (AB IV) – \$9.95
- ___ 513 Mutants in Avalon™ (AB V) – \$16.95
- ___ 514 Mutants in Orbit™ (AB VI) – \$16.95
- ___ 515 Aliens Unlimited™ – \$24.95
- ___ 516 Heroes Unlimited™ G.M.'s Guide – \$24.95
- ___ 517 Century Station™ – \$24.95
- ___ 518 Gramercy Island™ – \$24.95
- ___ 519 Aliens Unlimited Galaxy Guide™ – \$24.95
- ___ 520 Mutant Underground™ – \$16.95
- ___ 521 Powers Unlimited® One – \$16.95
- ___ 522 Powers Unlimited® Two – \$16.95
- ___ 523 Powers Unlimited® Three – \$16.95
- ___ 525 Revised Ninjas & Superspies™ – \$20.95
- ___ 526 Mystic China™ – \$24.95
- ___ 527 Armageddon Unlimited™ – \$20.95

Robotech® RPG

- ___ 550 Robotech® The Shadow Chronicles® RPG (manga size) – \$16.95
- ___ 550HC Robotech® The Shadow Chronicles® Deluxe Hardcover RPG – \$30.95
- ___ 5500HC Robotech® The Shadow Chronicles® Gold Ed. Hardcover RPG – \$70.00
- ___ 551 Robotech® Macross® Saga Sourcebook – \$16.95
- ___ 552 Robotech® The Masters Saga™ Sourcebook (NEW in 8½ x 11) – \$20.95
- ___ 553 Robotech®: Expeditionary Force Marines Sourcebook – \$20.95
- ___ 554 Robotech® The New Generation™ Sourcebook – \$16.95
- ___ 555 Robotech® Genesis Pits Sourcebook – \$16.95

Robotech® RPG Tactics™ (New!)

- ___ 55100 Robotech® RPG Tactics™ – \$99.95
- ___ 55105 Robotech® RPG Tactics™ Rulebook – \$20.00
- ___ 55101 UEDF Dice Pack – \$12.00
- ___ 55102 Zentraedi Dice Pack – \$12.00
- ___ 55201 UEDF Valkyrie Wing – \$36.95
- ___ 55202 UEDF Destroid Pack – \$32.95
- ___ 55203 UEDF Spartan Pack – \$32.95
- ___ 55401 Zentraedi Regult Battlepods – \$36.95
- ___ 55402 Zentraedi Artillery Battlepods – \$36.95
- ___ 55403 Zentraedi Glaug Command – \$36.95

Rifts® Chaos Earth®

- ___ 660 Rifts® Chaos Earth® RPG – \$20.95
- ___ 661 Rifts® CE Creatures of Chaos™ – \$12.95
- ___ 662 Rifts® CE The Rise of Magic™ – \$12.95
- ___ 665 Rifts® Chaos Earth® First Responders™ – \$16.95 (coming)
- ___ 666 Rifts® Chaos Earth® Resurrection™ – \$20.95

Beyond the Supernatural™

- ___ 700 Beyond the Supernatural™, 2nd Ed. – \$24.95
- ___ 702 Tome Grotesque™ – \$20.95 (coming)
- ___ 703 Beyond Arcanum™ – \$24.95 (coming)

Nightbane®

- ___ 730 Nightbane® RPG – \$24.95
- ___ 731 Nightbane®: Between the Shadows™ – \$20.95
- ___ 732 Nightbane®: Nightlands™ – \$20.95
- ___ 733 Nightbane®: Through the Glass Darkly™ – \$20.95
- ___ 735 Nightbane® Survival Guide™ – \$20.95
- ___ 736 Nightbane® Dark Designs™ – \$20.95

Rifts®

- ___ 800HC Rifts® RPG Ultimate Edition – \$39.95
- ___ 801 Rifts® Sourcebook One Revised – \$20.95
- ___ 802-E Rifts® World Book 1: Vampire Kingdoms™, Revised – \$24.95
- ___ 803 Rifts® Conversion Book One™ – \$24.95
- ___ 804 Rifts® WB 2: Atlantis™ – \$20.95
- ___ 805 Rifts® Sourcebook 2: Mechanoids™ – \$16.95
- ___ 807 Rifts® WB 3: England™ – \$20.95
- ___ 808 Rifts® WB 4: Africa™ – \$20.95
- ___ 809 Rifts® Dimension Book 1: Wormwood™ – \$20.95
- ___ 810 Rifts® WB 5: Triax™ – \$24.95
- ___ 811 Rifts® Pantheons of the Megaverse® – \$24.95
- ___ 812 Rifts® Sourcebook 3: Mindwerks™ – \$16.95
- ___ 813 Rifts® Mercenaries™ – \$20.95
- ___ 814 Rifts® WB 6: South America – \$20.95
- ___ 815 Rifts® WB 7: Underseas™ – \$24.95
- ___ 816 Rifts® DB 2: Phase World® – \$24.95
- ___ 817 Rifts® DB 3: Phase World® Sourcebook – \$16.95
- ___ 818 Rifts® WB 8: Rifts® Japan™ – \$24.95
- ___ 819 Rifts® WB 9: South America Two™ – \$24.95
- ___ 820 Rifts® WB 10: Juicer Uprising™ – \$20.95
- ___ 821 Rifts® WB 11: Coalition War Campaign™ – \$24.95
- ___ 822 Rifts® WB 12: Pyscape™ – \$20.95
- ___ 825 Rifts® WB 13: Lone Star™ – \$20.95

- ___ 826 Rifts® WB 14: New West™ – \$24.95
 ___ 827 Rifts® WB 15: Spirit West™ – \$24.95
 ___ 828 Rifts® Sourcebook 4: Coalition Navy™ – \$16.95
 ___ 829 Rifts® WB 16: Federation of Magic™ – \$20.95
 ___ 830 Rifts® DB 4: Skraypers™ – \$20.95
 ___ 831 Rifts® Index Volume Two™ – \$16.95
 ___ 832 Rifts® WB 17: Warlords of Russia™ – \$24.95
 ___ 833 Rifts® WB 18: Mystic Russia™ – \$20.95
 ___ 834 Rifts® WB 19: Australia – \$24.95
 ___ 835 Rifts® WB 20: Canada™ – \$24.95
 ___ 836 Rifts® WB 21: Splynn Dimensional Market™ – \$24.95
 ___ 837 Rifts® WB 22: Free Quebec™ – \$24.95
 ___ 838 Rifts® WB 23: Xiticix Invasion™ – \$20.95
 ___ 839 Rifts® Coalition Wars®: Sedition™ – \$20.95
 ___ 840 Rifts® Coalition Wars®: Coalition Overkill™ – \$16.95
 ___ 841 Rifts® Coalition Wars®: Sorcerers' Revenge™ – \$16.95
 ___ 842 Rifts® Coalition Wars®: Cyber-Knights™ – \$16.95
 ___ 843 Rifts® Coalition Wars®: Shadows of Evil™ – \$16.95
 ___ 844 Rifts® Coalition Wars®: Final Siege™ – \$24.95
 ___ 845 Rifts® Game Master Guide™ – \$26.95
 ___ 846 Rifts® Aftermath™ – \$24.95
 ___ 847 Rifts® DB5: Anvil Galaxy™ – \$20.95
 ___ 848 Rifts® Book of Magic™ – \$26.95
 ___ 849 Rifts® Adventure Guide™ – \$24.95
 ___ 850 Rifts® Bionics Sourcebook™ – \$16.95
 ___ 851 Rifts® DB 6: Three Galaxies™ – \$20.95
 ___ 852 Rifts® Dark Conversions™ – \$24.95
 ___ 853 Rifts® Chi-Town 'Burbs™ – \$9.95
 ___ 854 Rifts® The Tolkeen Crisis™ – \$12.95
 ___ 855 Rifts® The Black Vault™ – \$9.95
 ___ 856 Rifts® The Vanguard™ – \$9.95
 ___ 857 Rifts® WB 24: China One™ – \$20.95
 ___ 858 Rifts® WB 25: China Two™ – \$20.95
 ___ 859 Rifts® DB 7: Megaverse Builder™ – \$16.95
 ___ 860 Rifts® DB 8: Naruni Wave 2™ – \$16.95
 ___ 862 Rifts® WB 26: Dinosaur Swamp™ – \$20.95
 ___ 863 Rifts® MercTown™ – \$20.95
 ___ 865 Rifts® Merc Ops™ – \$20.95
 ___ 866 Rifts® WB 27: Adventures in Dinosaur Swamp™ – \$20.95
 ___ 867 Rifts® Mercenary Adventure Sourcebook – \$12.95
 ___ 868 Rifts® WB 28: Arzno™ – \$20.95
 ___ 869 Rifts® WB 29: Madhaven™ – \$16.95
 ___ 870 Rifts® John Zeleznik Coloring Book – \$5.95
 ___ 871 Rifts® Machinations of Doom™ – \$18.95
 ___ 872 Rifts® DB 10: Hades™ – \$24.95
 ___ 873 Rifts® DB 11: Dyval™ – \$24.95
 ___ 874 Rifts® WB 30: D-Bees of North America™ – \$24.95
 ___ 875 Rifts® DB12: Dimensional Outbreak – \$24.95
 ___ 876 Rifts® Megaverse® in Flames™ – \$24.95
 ___ 876HC Rifts® Megaverse® in Flames™ Gold Hardcover Edition – \$50.00
 ___ 877 Rifts® Heroes of the Megaverse® – \$16.95
 ___ 878 Rifts® Sourcebook: Shemarrian Nation™ – \$16.95
 ___ 880 Phase World®: Fleets of the Three Galaxies™ – \$16.95
 ___ 881 Rifts® WB 31: Triax™ Two – \$24.95
 ___ 883 Rifts® DB 14: Thundercloud Galaxy™ – \$20.95
 ___ 884 Rifts® Vampires Sourcebook™ – \$20.95
 ___ 885 Rifts® WB 32: Lemuria™ – \$24.95
 ___ 886 Rifts® Black Market™ – \$24.95
 ___ 886HC Rifts® Black Market™ Hardcover Gold Edition – \$60.00
 ___ 887 Rifts® WB 33: Northern Gun™ One – \$24.95
 ___ 888 Rifts® WB 34: Northern Gun™ Two – \$26.95
 ___ 889 Rifts® Sourcebook: Coalition States, Heroes of Humanity™ – \$20.95
 ___ 890 Rifts® Dimension Book 15: Secrets of the Atlanteans™ – \$24.95
 ___ 890HC Rifts® DB 15: Secrets of the Atlanteans™ Gold Edition – \$50.00
 ___ 891 Rifts® World Book: Sovietski™ – \$24.95 (coming)
 ___ 892 Rifts® Sourcebook: The Disavowed™ – \$16.95 (coming)
 ___ 893 Rifts® CS: Heroes of Humanity™ Arsenal Sourcebook – \$16.95 (coming)
 ___ 894 Rifts® Haunted Tech™ – \$16.95 (coming)
 ___ 895 Rifts® Living Nowhere™ – \$16.95 (coming)
 ___ 2510 Rifts® & The Megaverse® Art Book – \$22.95
 ___ 2510-HC Rifts® & The Megaverse® Art Book, Hardcover – \$50.00
 ___ 2510-CML Rifts® & The Megaverse® Art Book, Collector's Masterwork – \$125.00
- Miscellaneous Products**
 ___ 600 Deluxe Revised RECON® RPG – \$22.95
 ___ 2537 Gamer Coffee Mug – \$10.00
 ___ 2545 Dead Reign™ Coffee Mug – \$10.00
 ___ 2554 Palladium Bookmarks, Set One – \$5.00
 ___ 2555 Palladium Bookmarks, Set Two – \$5.00
 ___ 2561 Property of Chi-Town Library Pencil – \$0.50 each
 ___ 2562 Future Visions™ – The Artistry of Charles Walton II – \$13.95
 ___ 2566 Glitter Boy Mouse Pad – \$9.95
 ___ 2567 Old Ones Mouse Pad – \$9.95
 ___ 2568 Zombie Graveyard Mouse Pad – \$9.95
 ___ 2575 Rifts Poker Cards 1 (full color) – \$11.99
 ___ 2576 Rifts Poker Cards 2 (line art) – \$11.99
- Note:** T-shirts and other products can be found online: www.palladiumbooks.com
- Rifts® Miniatures**
 ___ MI8002 Xiticix Pack – \$18.00
 ___ MI8004 Coalition Dog Pack – \$18.00
 ___ MI8005 Men of Magic Pack #1 – \$18.00
 ___ MI8006 Cyborgs Pack #1 – \$18.00
 ___ MI8007 Simvan & Ostrosaurus Pack – \$18.00
 ___ MI8008 Coalition Skelebots Pack #1 – \$18.00
 ___ MI8009 Coalition SAMAS Pack #1 – \$22.00
 ___ MI8010 Coalition Sky Cycle Pack – \$22.00
 ___ MI8011 Coalition Dog Pack #2 – \$18.00
 ___ MI8015 Damaged Skelebots Pack #1 – \$12.00
 ___ MI8016 Cyber-Adventurers Pack – \$18.00
 ___ MI8017 Rogues & Scout Pack #1 – \$18.00
 ___ MI8018 Brodkil & Witchling Pack – \$18.00
 ___ MI8019 Damaged Skelebots Pack #2 – \$18.00
 ___ MI8020 Psi-Stalkers & Scouts Pack #1 – \$18.00
 ___ MI8021 Shadow Beast – \$12.00
 ___ MI8022 Mystic Knight – \$6.00
 ___ MI8023 Lord Magus – \$6.00
 ___ MI8024 High Magus – \$6.00
 ___ MI8025 Coalition Psi-Stalker – \$6.00
 ___ MI8026 Coalition Dog Boy in DPM-D1 Armor – \$6.00
 ___ MI8027 Coalition Dog Boy #2 – \$6.00
 ___ MI8028 Coalition Dog Boy #3 – \$6.00
 ___ MI8029 Coalition Dog Boy #4 – \$6.00
 ___ MI8030 Coalition Dog Boy #5 – \$6.00
 ___ MI8031 Glitter Boy – \$20.00
 ___ MI8032 Glitter Boy Pilot – \$6.00
 ___ MI8033 Kydian Overlord – \$20.00
 ___ MI8034 Dragonsaurus – \$10.00
 ___ MI8035 Slaver and Slave (Atlantis) Set – \$10.00
 ___ MI8036 Crazy – \$6.00
 ___ MI8037 Juicer #1 – \$6.00
 ___ MI8038 Juicer #2 – \$6.00
 ___ MI8039 Cyborg #1 – \$12.00
 ___ MI8040 Cyborg #2 – \$12.00
 ___ MI8041 Cyborg #3 – \$6.00
 ___ MI8042 Coalition Officer – \$6.00
 ___ MI8043 Coalition Grunt #1 – \$6.00
 ___ MI8044 Coalition Grunt #2 – \$6.00
 ___ MI8045 Coalition Grunt #3 – \$6.00
- When placing an order by mail, please add money for shipping and handling.** Add \$5.00 for orders totaling \$1-\$50, \$10.00 for orders totaling \$51-\$95, and for orders totaling \$96-\$200 please add \$15.00 US. Double the amount for Canada, and *quadruple* it for overseas orders. For more shipping options, order online at www.palladiumbooks.com.
 Allow 2-4 weeks for delivery.
 Make checks and money orders payable to: *Palladium Books*
Check release dates for new products. If the book you order has not been released yet, your order will be held as a backorder until the product is available. Please note that prices are subject to change without notice.
Orders can also be placed by phone, at (734) 721-2903 (order line only). Please have your credit card information when you call.
- www.palladiumbooks.com**



Other Games from Palladium Books®

Beyond the Supernatural™ RPG

You are one of the few who knows psychic abilities, magic, ghosts, demons and the supernatural are real. You use that knowledge to help the innocent and battle evil.

- Horror role-playing set in our modern world.
- 14 Psychic Character Classes and Ordinary People.
- More than 100 psychic abilities.
- World background and creatures of darkness.
- A complete RPG, 256 pages, Cat. No. 700.

Heroes Unlimited™ RPG

- Over 100 super abilities, 40 psionic powers, and 100 magic spells, plus enchanted weapons and objects.
- Super vehicles, gimmicks and gizmos.
- Aliens, mutants, cyborgs, robots, martial artists and more.
- 352 pages of super-powered adventure! Cat. No. 500.

Ninjas & Superspies™ RPG

- 41 different martial arts.
- Dozens of mystic powers.
- Superspies and secret organizations.
- Gimmicks, cyborg agents and more. Cat. No. 525.

Dead Reign® RPG

Civilization has crumbled. The walking dead have risen and feed upon the living. Can you survive when the dead reign?

- 6 Apocalyptic character classes. 7 different types of zombies.
- Zombie combat tips, survival advice and resources.
- Death Cults, world overview, and many adventure ideas.
- A complete role-playing game, 224 pages. Cat. No. 230.



Available at
stores everywhere

Nightbane®

A complete role-playing game of discovery, power, horror and conspiracy.

- **The Nightbane® R.C.C.** enables gamers to play supernatural shape-changers. Beings who can appear completely human, but are really superhuman creatures from the twilight dimension known as the *Nightlands™*.
- **Nightbane creation tables** — each Nightbane looks different (horrific, human, or strangely beautiful) and possesses different abilities.
- **Nightbane “Talents”** are supernatural and magic abilities of incredible power and range. The only catch, they must shed their human disguise and become a monster to use them.
- **Nearly a dozen other O.C.C.s and R.C.C.s** including the Sorcerer, Mystic, Vampire, Wampyr, Snake Bird, and Nightbane Mystic.
- **New magic, psionic abilities and supernatural powers.**
- **Nightlords and their minions** like the Hunters, Hounds, and Hollow Men.
- The *Nightlands™*, secret organizations, cults, madmen, and tons of campaign and adventure ideas.
- Compatible with *Beyond the Supernatural™*, *Heroes Unlimited™*, *Ninjas & Superspies™*, and *Mystic China™*, and adaptable to *Rifts®* and the entire *Palladium Megaverse®*.
- 240 pages!

One game system —
a Megaverse® of adventure™

\$24.95

Cat. No. 730

ISBN-10: 0-916211-86-X

ISBN-13: 978-0-916211-86-8

**Palladium
Books Inc.**

www.palladiumbooks.com